

BUILT TO A HIGHER STANDARD<sup>®</sup>

*American Standard*<sup>®</sup>

HEATING & AIR CONDITIONING

# QUICK REFERENCE GUIDE JANUARY 2022



# UPGRADE YOUR WEBSITE WITH CURRENT PRODUCT INFORMATION IN NO TIME.

Take advantage of our embeddable, customizable Online Product Guide. Add it to your website to show off the most up-to-date American Standard line-up.

## HOW DO I GET STARTED?

- STEP 1** Go to [ASAirProducts.com/db](https://ASAirProducts.com/db) and register for **FREE**
- STEP 2** Follow the simple on-screen instructions
- STEP 3** Copy your unique IFRAME code to your website

## WHAT HAPPENS NEXT?

Instantly, the full line of American Standard Products will be displayed on your website and will be updated whenever there are changes!

- ✓ One-time set up (Automatically Updates)
- ✓ Can be full-frame or within a div
- ✓ Fully responsive for mobile applications
- ✓ Select which products will appear on your website



# Contents - Residential

Model Nomenclature .....	TOC-5
<b>Connected Home Solutions</b>	
• Conventional 24 Volt Smart Thermostat.....	CHS-1
• AccuLink™ Communicating Smart Thermostat .....	CHS-2
• American Standard® Home Compatible Products.....	CHS-3
<b>Split System Cooling</b>	
• AccuComfort™ Variable Speed Single Phase, 2-5 Tons (4A7V0, 4A7V8) .....	SC-1
• Single Phase, 1½-5 Tons (4A7A7, 4A7A6, 4A7L6).....	SC-3
• Single Phase, 1½-5 Tons (4A7A4, 4A7A3) .....	SC-5
• Three Phase (4A7C7, 4A7C4, 4A7C3, 4A7S6) .....	SC-7
<b>Split System Heat Pumps</b>	
• Summary of System Ratings .....	SH-1
• AccuComfort™ Variable Speed Single Phase, 2-5 Tons (4A6V0, 4A6L9, 4A6V8).....	SH-3
• Single Phase, 1½-5 Tons (4A6H7, 4A6H6, 4A6L6) .....	SH-5
• Single Phase, 1½-5 Tons (4A6H5, 4A6H4).....	SH-7
• Three Phase (4A6C7, 4A6C4, 4A6S6) .....	SH-9
<b>Air Handlers/Heaters</b>	
• Features and Benefits .....	AH-1
• Forefront TAM9 Variable Speed Multi-Position, 2-5 Tons (TAM9).....	AH-2
• Multi-position Chart.....	AH-4
• Forefront GAM5 Multi-Position, Single Phase, 1½-5 Tons (GAM5).....	AH-5
• Forefront GAF2 Split System, Single Phase, 2-3 Tons (GAF2).....	AH-7
• Heaters for Multi-Position Air Handlers .....	AH-9
• TEM Split System, Single Phase, 1½-5 Tons (TEM8, TEM6, TEM4).....	AH-11
• Heaters for TEM.....	AH-13
• TMM Wall, Stud, or Over the Water Heater, Single Phase, 1½-3 Tons (TMM5, TMM4) .....	AH-15
• P-Series Modular Blower - Variable Speed (P0V0) (CALIFORNIA ONLY) .....	AH-17
<b>Coils</b>	
• Split System Aluminum Cased Heat Pump and Cooling (4TXC-DS, 4PXC-U, 4PXC-D).....	COIL-1
• Split System Aluminum Uncased Heat Pump and Cooling (4PXA-U) .....	COIL-2
• Split System Aluminum Cased Heat Pump and Cooling (4PXF) .....	COIL-3
• Split System Aluminum Cased Heat Pump and Cooling (4MXC) .....	COIL-4

.....

This publication is for general reference information only and is not intended for systems equipment / combination selections.

Products listed in this book are not always carried in factory/distributor inventory, nor are all products available through all distribution channels. Consult your Distributor for availability and shipping information.

Since American Standard Heating & Air Conditioning has a policy of continuous product improvement, it reserves the right to change design and specification without notice.

.....

# Contents - Residential

## Furnaces

- S9V2-VS, S9V2 Two Stage Variable Speed ECM..... FUR-1
- S9X2 Two Stage High Efficiency ECM..... FUR-2
- S9X1, S9B1 Single Stage High Efficiency ECM..... FUR-4
- Platinum 95 Convertible Gas Furnace Airflow Directions..... FUR-6
- Platinum 95 Modulating Communicating Variable Speed (AUHM, ADHM)..... FUR-7
- Special Use Furnace Accessories..... FUR-10
- S8X2 Two Stage ECM..... FUR-11
- S8X1 Single Stage ECM..... FUR-11
- S8B1 Single Stage ECM..... FUR-12
- Platinum 80, Gold 80v Airflow Directions..... FUR-14
- Platinum 80 Two Stage Variable Speed (AUD2-ACV, ADD2-ACV)..... FUR-15
- Gold 80v Two Stage Variable Speed (AUD-A-V-V, ADD-A-V-V)..... FUR-15
- High Efficiency Oil Furnaces Ordering Information..... FUR-18
- L8X1 Single Stage, Ultra-Low NOx Gas Furnace (CALIFORNIA ONLY)..... FUR-19
- L9X1 Single Stage, Ultra-Low NOx Gas Furnace (CALIFORNIA ONLY)..... FUR-20

## Indoor Air Quality

- AccuClean™ Whole Home Air Cleaner (AFD).....IAQ-1
- Perfect Fit™ Filter Accessories and SlimFit Filters.....IAQ-2
- QuikBox™ Media Cabinet and Filters (TFM).....IAQ-3
- Humidifiers Steam (EHUMD8).....IAQ-4
- Humidifiers Fan Powered and Bypass (EHUMD5, EHUMD3, EHUMD2).....IAQ-5
- Whole Home Dehumidifiers with optional Ventilation (EDHUM).....IAQ-6
- Inline Ventilator (QF130V).....IAQ-7
- Energy Recovery Ventilator (ERV).....IAQ-8

## Smart Thermostats/Zone Sensors

- Conventional 24 Volt Smart Thermostat.....CCZS-1
- AccuLink™ Communicating Smart Thermostat.....CCZS-3
- Zoning Communicating Sensor with Display.....CCZS-5
- Conventional 24 Volt HVAC System Interface Relay Panel for  
AccuLink™ Controls.....CCZS-6
- AccuLink™ Platinum 1050 Control Component Overview.....CCZS-7
- AccuLink™ Zoning Assembly & Zone Expander Panel.....CCZS-8
- AccuLink™ Zoning Component Overview.....CCZS-9
- 24 Volt Modulating Dampers.....CCZS-11
- Programmable Touchscreen Thermostats.....CCZS-16
- Programmable Thermostats.....CCZS-17
- Non-Programmable Comfort Controls.....CCZS-18
- Non-Programmable Thermostats.....CCZS-19
- Remote Sensors.....CCZS-20
- Outdoor Thermostat Kit.....CCZS-21

# Contents - Residential

## Packaged Units

- Cooling Convertible, 2-5 Tons (4TCY5, 4TCY4, 4TCC4)..... PK-1
- Hybrid/Dual Fuel Convertible, 2-5 Tons (4DCZ6, 4DCY4)..... PK-4
- Heating Convertible, 2-5 Tons (4WCZ6, 4WCY5, 4WCC4, 4WCY4)..... PK-7
- Heating Over/Under 2-3.5 Tons (4WHC4) ..... PK-10
- Gas/Electric Convertible, 2-5 Tons (4YCZ6, 4YCY5, 4YCY4) ..... PK-11
- Gas/Electric Convertible, 2-5 Tons (4YCC4)..... PK-12
- Convertible, 2-5 Tons Single Power Entry Kits..... PK-15
- Convertible, 2-5 Tons Supplemental Heaters..... PK-16

## Ameristar™

- Model Nomenclature..... AMNOM-1
- Split System Cooling Single Phase – 1½-5 Tons (A4AC3, A4AC4, A4AC6)... AMSC-1
- Split System Heat Pumps Single Phase – 1½-5 Tons (A4HP4, A4AHP6)..... AMSH-1
- Split System Air Handlers Single Phase 1½-5 Tons (A4AH4, A4AH6) ..... AMAH-1
- TMM Wall, Stud, or Over the Water Heater Mount  
Air Handlers Single Phase, 1½-3 Tons (TMM5, TMM4)..... AMAH-4
- Split System – Cased Heat Pump and Cooling Coils (4MXC)..... AMCOIL-1
- A801X - Single Stage ECM (A801X) ..... AMFUR-1
- A951X - Single Stage ECM (A951X) ..... AMFUR-3
- A952V - Two Stage, Variable Speed ECM (A952V) ..... AMFUR-3
- Packaged Cooling Convertible 2-5 Tons (4TCA4)..... AMPK-1
- Packaged Heat Pump Convertible 2-5 Tons (4WCA4)..... AMPK-3
- Packaged Gas/Electric Convertible 2-5 Tons (4YCA4) ..... AMPK-5

## Accessories/Information

- Roof Curbs (BAYCURB050A, BAYCURB051A) ..... AC/IN-1
- Thermal Expansion Valves..... AC/IN-2
- Equipment Date Identification ..... AC/IN-4
- Refrigerant Line Sets ..... AC/IN-5
- Refrigerant HFC 410A (R-410A)..... AC/IN-6
- Refrigerant Piping Information for Two Stage Split Systems..... AC/IN-7
- Split Systems with Side Discharge Variable Speed Compressor..... AC/IN-8
- Branch Circuit Wire Sizing Table/Heater De-Rating Chart ..... AC/IN-9
- Basic Air Conditioning Formulas..... AC/IN-10
- Low Ambient Accessories, Cooling & Heating Models ..... AC/IN-11

# Contents - Light Commercial

## Precedent Packaged Systems

- Features and Benefits ..... LPRE-2
- Application Considerations ..... LPRE-17

### 3-10 Ton Packaged Cooling

- Selection Procedure..... LPRE-19
- Model Number Description ..... LPRE-23
- General Data (T/YSC)..... LPRE-27

### 3-5 Ton Packaged Cooling

- Selection Procedure..... LPRE-37
- Model Number Description ..... LPRE-41
- General Data (T/YHC) ..... LPRE-43

### 3-10 Ton Packaged Heat Pumps

- Selection Procedure..... LPRE-45
- Model Number Description ..... LPRE-47
- General Data (WSC)..... LPRE-49
- General Data (WHC)..... LPRE-52
- General Data (DHC) ..... LPRE-55

## Voyager Packaged Systems

- Features and Benefits ..... LVOY-2

### Packaged Gas / Electric

- Application Considerations ..... LVOY-18
- Selection Procedure..... LVOY-20
- Model Number Description ..... LVOY-22
- General Data..... LVOY-24

### Packaged Heat Pumps

- Application Considerations ..... LVOY-36
- Selection Procedure..... LVOY-37
- Model Number Description ..... LVOY-39
- General Data..... LVOY-41

## Foundation Packaged Systems

### 3-5 Ton Cooling and Gas

- Features and Benefits ..... LFOU-2
- Application Considerations ..... LFOU-10
- Selection Procedure..... LFOU-11
- Model Number Description ..... LFOU-13
- General Data..... LFOU-14

### 15-25 Ton Cooling and Gas

- Features and Benefits ..... LFOU-16
- Application Considerations ..... LFOU-24
- Selection Procedure..... LFOU-25
- Model Number Description ..... LFOU-27
- General Data..... LFOU-28

## Odyssey Split Systems

- Features and Benefits..... LODY-2
- Accessories ..... LODY-9
- Application Considerations ..... LODY-14

### Split System Cooling

- Selection Procedure..... LODY-16
- Model Number Description ..... LODY-18
- General Data..... LODY-20

### Split System Heat Pumps

- Selection Procedure..... LODY-26
- Model Number Description ..... LODY-28
- General Data..... LODY-30

# Model Nomenclature Residential

## Outdoor Units

1 2 3 4 5 6 7 8 9 10 11 12 13 14 15  
4 A 7 A 4 0 6 0 A 1 0 0 0 A A

- Refrigerant Type**  
2 = R-22  
4 = R-410A
- Brand**  
A = American Standard
- System Type**  
6 = HP  
7 = AC
- Product Family**  
A = Silver/Gold AC      L = Side Discharge  
B = XB                      V = Platinum VSD  
C = Light Commercial    Z = 2 Recip 20 SEER  
H = Silver/Gold HP
- Nominal Rated SEER**  
0 = 20 SEER      6 = 16 SEER  
3 = 13 SEER      7 = 17 SEER  
4 = 14 SEER      8 = 18 SEER  
5 = 15 SEER
- Field Connection**  
0 = Brazed
- Nominal Tonnage**  
12 = 1.0    24 = 2.0    36 = 3.0    48 = 4.0  
18 = 1.5    25 = 2.0    37 = 3.0    49 = 4.0  
19 = 1.5    30 = 2.5    42 = 3.5    60 = 5.0  
              31 = 2.5    43 = 3.5    61 = 5.0
- Major Design Change**  
A thru Z Note: No F, I, O
- Power Supply Voltage/Phz/Hz**  
1 = 200-208-230/1/60  
3 = 200-230/3/60  
4 = 460/3/60
- Other Functions**  
000 = Typical-no meaning  
COT = Coated PlateFin
- Minor Design Change**  
A thru Z Note: No F, I, O
- Service Digit - Not Orderable**  
A thru Z Note: No F, I, O

## Accessories

1 2 3 4 5 6 7 8 9 10 11  
A Y E C O N O 0 1 A A

- Denotes: Accessories**
- Accessories Type (Example: BAYCURB, AY,ASY)**
- |                                 |                               |
|---------------------------------|-------------------------------|
| ASCT = Anti-Cycle Timer         | LOAM = Low Ambient Controls   |
| BARM = Barometric Relief        | LPKT = L.P. Kit               |
| BASE = Subbase                  | LSDR = Low Static Drive       |
| BRZQ = Coupling Kit Adaptors    | NXKT = NOx Rod Accessory Kit  |
| CCHT = Crankcase Heater         | PANL = Panel                  |
| CLE = Coil Enclosures           | PLNM = Plenum                 |
| CURB = Roof Curb                | PLUS = Add-on Heat Pump       |
| DMPR = Damper                   | REFLN = Refrigerant Lines     |
| DNFLW = Downflow Conversion Kit | RLAY = Relay                  |
| ECMT = Extreme Mounting Kit     | SEAC = Sea Coast Kit          |
| ECON = Economizer               | SENS = Sensor                 |
| ENTH = Enthalpy Control         | SPEK = Single Power Entry Kit |
| FLTR = Filter                   | STAT = Thermostat             |
| GARD = Coil Guard               | TBKT = Thru Base Utility Kit  |
| GRLE = Return Air Grill         | TEST = Test Accessory         |
| HALT = High Altitude Kit        | TFMR = Transformer            |
| HGBP = Hot Gas Bypass Control   | TWIN = Twinning Kits          |
| HSMT = High Static Motor        | TXVA = Cooling —              |
| HTRA = Electric Heater          | Bleed/Non Bleed Kits          |
|                                 | TXVH = Heat Pump              |
|                                 | Non Bleed Kits                |
|                                 | UTIL = Curb Ext. Kit          |
| ISLT = Isolator                 | VENT = Termination Kit        |
| KSKT = Start Accessory Kit      | WAR = Warranty                |
| LEGS = Snow Legs                | WATR = Hydronic Heat Coils    |
| LEGSCAP = Leveling Caps         | WRKT = Wire Kit               |
| LIFT = Lifting Lug Kit          | 2STG = 2 Stage Gas            |
- Major Design Change**  
Numbers Are Sequentially Assigned Except For Electric Heaters. On Electric Heaters Digit 8 Is Used To Identify Voltage And Digit 9 And 10 Are Used To Identify Capacity In KW's.
- Minor Design Change**  
Accessory To Unit Match-up (When Required)
- Service Digit - Not Orderable**

## ForeFront Air Handler

1 2 3 4 5 6 7 8 9 10 11 12 13 14 15  
G A M 2 A 0 A 3 6 S 3 1 S A A

- Brand**  
T = American Standard  
G = Good (American Standard Branded)
- Product Type**  
A = Air Handler  
E = Air Handler
- Convertability**  
M = Multi-poise 4-way  
F = Upflow Front Return, 3-way  
T = 3-way
- Product Tier**  
2 = Good, Entry Level Feature Set  
4 = Better, Retail Replacement Mid Effy.  
5 = Better, Entry Level High Effy., Multi-Speed  
7 = Best, Retail Replacement High Effy., Variable-Speed  
8 = Best, Retail Ultimate High Effy., Variable-Speed  
9 = Best, Comm/24V Variable-Speed  
G = Best, Geothermal
- Major Design Change**
- No Descriptor**  
0 = Air Handler / Coil
- Size (Footprint)**  
A = 17.5 x 21.8  
B = 21.3 x 21.8  
C = 23.5 x 21.8
- Cooling Size: Air Handler or Coil**  
0-9 = AH Coil - 1000 BTU's (18, 24, 30, 36, 42, 48, 60)
- Airflow Type & Capability**  
S = Standard Effy PSC, 1-5 - nom. Tonnage (cfm/ton)  
M = Mid Effy Multi-Speed, 1-5 - nom. Tonnage (cfm/ton)  
H = High Effy Variable, 1-5 - nom. Tonnage (cfm/ton)  
V = High Effy Variable, 1-5 - nom. Tonnage (cfm/ton)
- Power Supply**  
1 = 208-230/1/60
- System Control Type**  
S = Standard - 24 VAC  
C = CLII 13.8 VDC  
D = Dual (24 VAC / CLII 13.8 VDC) and Epoxy Coated Coil Fins  
E = Epoxy Coated Coil Fins
- Minor Design Change**
- Service Digit - Not Orderable**

## ForeFront Air Handler Electric Heaters

1 2 3 4 5 6 7 8 9 10 11 12 13 14 15  
B A Y E A A C 1 5 B K 1 A A A

- Brand**  
B = Both Brands
- Product Type**  
AY = Accessory
- Heat Type**  
E = Electric Heater
- Product Tier**  
A = TAM9, TAM4, GAM5, TAMGB  
E = TAM8, TAM7  
C = GAF2
- Size (Footprint)**  
A-C = Minimum Cabiner Width
- Size (Footprint)**  
A-C = Maximum Cabiner Width
- Electric Heat Input**  
Electric Heat kW
- Connection**  
BK = Breaker  
LG = Lugs
- Power Supply**  
1 = 208-230/1/60  
A = 200/1/50  
3 = 208-230/3/60
- Major Design Modification**
- Minor Design Modification**
- Service Digit - Not Orderable**

For complete equipment / combination selections, installation instructions and warranty information, please refer to Product Data/Ratings and/or Installers Guides and Limited Warranty Handbooks.

BUILT TO A HIGHER STANDARD

*American Standard*

HEATING & AIR CONDITIONING

# Model Nomenclature Residential

## Air Handler - Residential

1 2 3 4 5 6 7 8 9 10 11 12 13 14 15  
T E M A O B 3 6 S 3 1 S A A

- Brand** \_\_\_\_\_  
T = American Standard
- Product Type** \_\_\_\_\_  
E = Metal Cabinet  
M = Metal Over Hot Water Heater
- Convertability** \_\_\_\_\_  
M = Multi-poise 4-way
- Product Tier** \_\_\_\_\_  
3 = Entry Level Multi-Speed  
4 = Entry Level Multi-Speed  
5 = Entry Level High Efficiency  
6 = Entry Level Variable Speed  
8 = Entry Level Comm/24V Variable Speed
- Major Design Change** \_\_\_\_\_
- No Descriptor** \_\_\_\_\_  
0 = Air Handler / Coil
- Size (Footprint) (W x D)** \_\_\_\_\_  
A = 20.5 x 15.0  
B = 18.5 x 21.1 (TEM), 22.0 x 19.0 (TMM)  
C = 23.5 x 21.1  
D = 26.5 x 21.1
- Cooling Size: Air Handler or Coil** \_\_\_\_\_  
0-9 = AH Coil - 1000 BTU's (18, 24, 30, 36, 42, 48, 60)
- Airflow Type & Capability** \_\_\_\_\_  
S = Standard Effy, 1-5 - nom. Tonnage (cfm/ton)  
M = Mid Effy Multi-Speed, 1-5 - nom. Tonnage (cfm/ton)  
H = High Effy Variable, 1-5 - nom. Tonnage (cfm/ton)  
V = High Effy Variable, 1-5 - nom. Tonnage (cfm/ton)
- Power Supply** \_\_\_\_\_  
1 = 208-230/1/60
- System Control Type** \_\_\_\_\_  
S = Standard - 24 VAC  
C = CLII 13.8 VDC  
D = Dual (24 VAC / CLII 13.8 VDC)
- Minor Design Change** \_\_\_\_\_
- Service Digit - Not Orderable** \_\_\_\_\_

## Air Handler/ Electric Furnace Heaters

1 2 3 4 5 6 7 8 9 10 11 12 13 14  
B A Y H T R 1 4 1 5 B R K A

- Accessory** \_\_\_\_\_
- Heater** \_\_\_\_\_
- Power Supply** \_\_\_\_\_  
1 = Single Phase  
3 = Three Phase
- Series/Family** \_\_\_\_\_  
3 = 2/4TEH Models Only  
4 = 4TEC / Legacy  
5 = TEM Models Only
- Heater KW** \_\_\_\_\_
- Electrical Connection** \_\_\_\_\_  
000 = Pig Tails Only  
BRK = Circuit Breaker  
PDC = Pull Disconnect  
RBR = Recessed Breaker-TVF018, TVF024, 14" Deep only  
RPD = Recessed Pull Disconnect-TVF018, TVF024, 14" Deep only
- Minor Design Change** \_\_\_\_\_

## Air Handler

1 2 3 4 5 6 7 8 9 10 11 12 13 14 15  
4 F W C A 0 2 4 A 1 0 0 0 A A

- Refrigerant Type** \_\_\_\_\_  
4 = R-410A
- Model Type** \_\_\_\_\_  
FWC = Convertible  
FWH = Convertible with Constant Torque ECM Motor  
FWM = Stud Mount with Factory Installed Electric Heat  
FWD = Furr-Down Uncased with Factory Installed Electric Heat  
FWF = Furr-Down Cased with Factory Installed Electric Heat
- Insulation** \_\_\_\_\_  
A = Standard  
F = R4.2 Insulation
- Capacity** \_\_\_\_\_  
Nominal Capacity in 1000's (BTUH)
- Major Design Change** \_\_\_\_\_
- Power Supply** \_\_\_\_\_  
1 = Single Phase
- Electrical Connection** \_\_\_\_\_  
0 = Pig Tails  
D = Pull Disconnect
- Electric Heater** \_\_\_\_\_  
00 = No heater  
05 = 5 KW  
08 = 8 KW  
10 = 10 KW  
15 = 15 KW  
20 = 20 KW
- Minor Design Change** \_\_\_\_\_
- Service Digit - Not Orderable** \_\_\_\_\_

For complete equipment / combination selections, installation instructions and warranty information, please refer to Product Data/Ratings and/or Installers Guides and Limited Warranty Handbooks.



# Model Nomenclature Residential

## Gas Furnaces

1 2 3 4 5 6 7 8 9 10 11 12 13 14 15  
A U D 1 B 0 8 0 A 9 H 3 1 A A

- Furnace Configuration**  
AU = Upflow/Horizontal  
AD = Downflow/Horizontal
- Type**  
E = 80% Induced Draft Standard  
D = 80% Induced Draft Premium  
C = 90% Condensing Standard  
X = 90% Condensing Premium  
H = 95% Condensing Premium
- Number of Heating Stages**  
1 = Single Stage  
2 = Two Stage  
3 = Three Stage  
M = Modulating
- Cabinet Width**  
A = 14.5" Cabinet Width  
B = 17.5" Cabinet Width  
C = 21.0" Cabinet Width  
D = 24.5" Cabinet Width
- Heating Input in 1000's (BTUH)**  
080 = 80,000 BTUH
- Major Design Change**
- Voltage**  
9 = 115 Volts / 60 Hertz / Natural Gas  
A = 115 Volts / 50 Hertz / Natural Gas  
C = 115 Volts / Natural Gas with Communicating System Control  
F = 115 Volts / Natural Gas with Integrated Electronic Filter  
D = 115 Volts / Natural Gas with Communicating System Control and Integrated Electronic Filter
- Air Capacity for Cooling**  
Standard PSC      Variable Speed      High Efficiency  
24 = 2 Tons      V3 = 3 Tons      H3 = 3 Tons  
36 = 3 Tons      V4 = 4 Tons      H4 = 4 Tons  
42 = 3.5 Tons      V5 = 5 Tons      H5 = 5 Tons  
45 = 4 Tons  
48 = 4 Tons  
54 = 5 Tons  
60 = 5 Tons  
72 = 6 Tons
- Draft Inducer Speeds**  
1 = Single Speed  
2 = Two Speed  
V = Variable Speed
- Minor Design Change**
- Service Digit - Not Orderable**

## S-Series Furnaces

1 2 3 4 5 6 7 8 9 10 11 12 13 14 15  
S 8 B 1 B 0 8 0 U 2 P S A A A

- Level**  
S = Series
- AFUE**  
8 = 80%  
9 = 90% or Higher
- Blower**  
B = Base model  
P = PSC  
X = CTM  
V = Variable Speed
- Gas Valve Stages**  
1 = Single Stage  
2 = 2 Stage  
M = Modulating
- Cabinet Width**  
A = 14.5"  
B = 17.5"  
C = 21"  
D = 24.5"
- BTU Input**  
080 = 80,000 BTUH
- Poise Options**  
U = 3 Way  
D = Dedicated Downflow  
M = 4 Way Poise
- Air Capacity for Cooling**  
(in nominal tons)  
2 = 2 Tons  
3 = 3 Tons  
4 = 4 Tons  
5 = 5 Tons
- Inducer Type**  
P = PSC  
X = CTM  
V = Variable Speed
- Communicating Capability**  
S = 24 Volt  
C = Communicating System Control
- Major Design Change**
- Minor Design Change**
- Service Digit - Not Orderable**

BUILT TO A HIGHER STANDARD

American Standard®

HEATING & AIR CONDITIONING

# Model Nomenclature Residential

## Heat Pump/ Cooling Coils

1 2 3 4 5 6 7 8 9 10 11 12 13 14 15  
4 T X C B 0 3 6 A C 3 H C A A

### Refrigerant Type

4 = R-410A

### Series

- T = Premium (Cooling and HP)
- N = Premium (Cooling and HP)
- P = Premium High Efficiency - Dedicated position (Cooling and HP)
- C = Standard (Cooling Only)
- F = Entry Level (Cooling Only)
- G = Entry Level (Cooling and HP)
- M = Entry Level (Cooling and HP)

### Coil Design

X = Direct Expansion Evaporator Coil

### Coil Feature

- C = Cased A Coil
- A = Uncased A Coil
- F = Cased Horizontal Flat Coil

### Coil Width (Cased/Uncased)

- A = 14.5" / 13.3"
- B = 17.5" / 16.3"
- C = 21.0" / 19.8"
- D = 24.5" / 23.3"
- H = 10.5"

### Refrigerant Line Coupling /

### Airflow Configuration

- 0 = Brazed
- U = Upflow only, convertible to Horizontal Left
- D = Downflow only, convertible to Horizontal Right

### Nominal Capacity in 1000's (BTUH) / Model Number Distinguisher

### Major Design Change

### Efficiency

- C = Standard
- S = High Efficiency (derived from 10 SEER products)
- Z = High Efficiency (TXV modulates to 50%)

### Refrigerant Control

- 3 = TXV - Non-Bleed
- 6 = FCCV (Flow Control/Check Valve)

### Coil Circuitry

- H = Heat Pump
- C = Cooling

### Airflow Configuration

- A = Upflow
- U = Upflow /Downflow
- D = Downflow
- R = Downflow / Horizontal Right
- H = Horizontal Left/Right
- C = Convertible - Upflow, Downflow, Left or Right

### Minor Design Change

Service Digit - Not Orderable

For complete equipment / combination selections, installation instructions and warranty information, please refer to Product Data/Ratings and/or Installers Guides and Limited Warranty Handbooks.

# Model Nomenclature Residential

### American Standard AccuClean™ Whole Home Air Cleaner

1 2 3 4 5 6 7 8 9 10 11 12 13 14 15  
A F D 1 4 5 A L F R 0 0 0 A A

**Brand** \_\_\_\_\_

**Filtration** \_\_\_\_\_

**ifD** \_\_\_\_\_

**Size** \_\_\_\_\_

Furnace Upflow	Furnace Downflow	Air Handler
145 = 14.5"	14D = 14.5"	215 = 21.5"
175 = 17.5"	17D = 17.5"	235 = 23.5"
210 = 21.0"	21D = 21.0"	260 = 26.0"
245 = 24.5"	24D = 24.5"	

**Major Design Series** \_\_\_\_\_

**Power Supply**  
L = Low Voltage

**Application**  
AH000 = Air Handler  
FR000 = Furnace

**Minor Design** \_\_\_\_\_

**Service Sequence Not Orderable** \_\_\_\_\_

### Perfect Fit™ Air Cleaner

1 2 3 4 5 6 7 8 9 10 11 12  
T F M 175 B 0 FR 1 1

**Filter** \_\_\_\_\_

**Filter Type** \_\_\_\_\_  
M = Media, 5 Inch, 1 Inch

**Product Dimension** \_\_\_\_\_

145 = 14.5 Inch Furnace Width	215 = 21.5 Inch Air Handler Width
175 = 17.5 Inch Furnace Width	235 = 23.5 Inch Air Handler Width
210 = 21.0 Inch Furnace Width	260 = 26.0 Inch Air Handler Width
245 = 24.5 Inch Furnace Width	

**Product Development Sequence** \_\_\_\_\_  
B = 5" Expandable Media

**Voltage** \_\_\_\_\_  
1 = 240V    9 = 140V

**Product Description**  
AH = Air Handler  
FR = Furnace

**Minor Design Change** \_\_\_\_\_

**Service Digit - Not Orderable** \_\_\_\_\_

### TXV Kits

1 2 3 4 5 6 7 8 9 10 11 12 13 14 15  
2 A Y T X V H 3 A 2 5 3 1 A A

**Refrigerant** \_\_\_\_\_  
4 = R-410A  
2 = R-22

**Accessory** \_\_\_\_\_

**Accessory Type** \_\_\_\_\_  
TXV Kit

**Compatibility** \_\_\_\_\_  
Cooling & Heat Pump Compatible

**Flow Control** \_\_\_\_\_  
3 = TXV - Non Bleed

**Major Design Change**  
B = Internally Mounted (Mechanical Fittings)  
C = Internally Mounted (Mechanical Fittings)  
D = Internally Mounted (Mechanical Fittings)

**Minimum Nominal Capacity in 000's BTU's** \_\_\_\_\_

**Maximum Nominal Capacity in 000's BTU's** \_\_\_\_\_

**Minor Design Change** \_\_\_\_\_

**Service Digit - Not Orderable** \_\_\_\_\_

### Perfect Fit™ Filter Accessories

1 23 45 67 89 10 11 12  
B AY FT FR EX M 2 A

**Business Unit** \_\_\_\_\_

**Accessory** \_\_\_\_\_

**Filter** \_\_\_\_\_

**Product Type** \_\_\_\_\_  
AH = Air Handler  
FR = Furnace

**Size** \_\_\_\_\_  
EX = Expandable

**Type** \_\_\_\_\_  
M = Media, 5 Inch

**Quantity** \_\_\_\_\_  
1 = 1    2 = 2    4 = 4    D = Dozen

**Minor Design Change** \_\_\_\_\_

# Model Nomenclature Residential

## Humidifiers

1 2 3 4 5 6 7 8 9 10 11 12 13 14 15  
E H U M D 8 0 0 A S M 0 0 B A

- Brand**
  - E = Dual Brand
  - A = American Standard
- Accessory Type**  
HUMD = Humidifier
- Model Series**  
200, 300, 500, 800
- Major Design Change**
- Humidifier Type**
  - B = Bypass, Flow Through
  - P = Fan Powered, Flow Through
  - S = Steam, Canister
- Control**
  - M = Manual
  - A = Automatic
- Secondary Function**
- Minor Design Change**
- Service Digit - Not Orderable**

## Humidifier Controls

1 2 3 4 5 6 7 8 9 10 11 12 13 14 15  
A C O N T H 0 1 A A U T O A A

- Brand**
- Accessory Type**  
CONT = Control
- Accessory**  
H = Humidifier
- Model Series**
- Major Design Change**
- Control Type - Automatic or Manual**
  - SENS = Sensing
  - 1310 = Height x Width (Dimensions)
  - MHCO = Manual Humidifier Control
- Minor Design Change**
- Service Digit - Not Orderable**

## Humidifier Accessories

1 2 3 4 5 6 7 8 9 10 11 12 13 14 15  
B A Y R L Y 1 0 A S E N S A A

- Accessory**
- Description**
  - RLY = Relay
  - PAD = Humidifier Replacement Pad
  - PLT = Adapter Plate
- Accessory Series**
- Major Design Change**
- Accessory Type**
  - SENS = Sensing
  - 1310 = Height x Width (Dimensions)
  - MHCO = Manual Humidifier Control
- Minor Design Change**
- Service Digit - Not Orderable**

## Energy Recovery Ventilator (ERV)

1 2 3 4 5 6 7 8 9 10 11 12 13 14 15  
E E R V R 1 0 0 A 1 P 0 0 B A

- General Descriptor**  
E = Dual Brand
- Product Type**  
ERV = Energy Recovery Ventilator
- Feature Tier**
  - B = Future
  - R = PSC Blower/PT Control
  - X = Future
- Model Family (Nominal Airflow)**
  - 100 = 130 cfm
  - 200 = 200 cfm
  - 300 = 300 cfm
- Major Design Change**
- Power Supply**  
1 = 115 v/1 ph/60 hz
- Type of Defrost**  
P = Passive
- Open Digits**
- Minor Design Change**
  - B = Polyslate Cabinet/Polyslate Door
  - Dual Badge Included
- Service Digit - Not Orderable**

# Model Nomenclature Residential

## Packaged Units

1 2 3 4 5 6 7 8 9 10 11 12 13 14 15  
4 Y C X 3 0 4 2 A 3 0 8 0 A A

**Refrigerant**  
4 = R-410A

**Type**  
Y = Gas Electric  
W = Heat Pump  
D = Dual Fuel  
T = Air Conditioner

**Configuration**  
C = Convertible  
H = Horizontal (only)

**Model Tier**  
C = Entry Level  
X = Upgrade  
Y = Premium  
Z = Leadership - (2-Stage)

**Efficiency Tier**  
3 = 13 SEER  
4 = 14 SEER  
5 = 15 SEER  
6 = 16 SEER

**Capacity in 1000's (BTUH)**  
018 042  
024 048  
030 060  
036

**Major Design Change**

**Voltage & Phase**  
1 = 230V 1 Phase  
3 = 230V 3 Phase  
4 = 460V 3 Phase

**Gas Heat Input (MBTU/H)**  
000 (AC or HP) 075  
040 096  
064 120

**Minor Design Change**

**Service Digit - Not Orderable**

## Packaged Units (Pre-410A Refrigerant)

1 2 3 4 5 6 7 8 9 10 11 12  
Y C X 0 3 6 G 1 M 0 A 0

**Product Type**  
TC = Cooling, Electric Heat  
WC = Heat Pump Packaged  
YC = Gas Electric  
DC = Heat Pump with Gas Heat

**Airflow Configuration**  
D = Downflow Y = Super High Efficiency  
H, K = Horizontal Z = Ultra High Efficiency  
C = Convertible  
X = High Efficiency

**Cooling Capacity in 1000's (BTUH)**  
018 = 1 1/2 Tons 060 = 5 Tons  
024 = 2 Tons 150 = 12 1/2 Tons  
030 = 2 1/2 Tons 180 = 15 Tons  
036 = 3 Tons 210 = 17 1/2 Tons  
042 = 3 1/2 Tons 240 = 20 Tons  
048 = 4 Tons 300 = 25 Tons

### Commercial High Efficiency Units

151 = 12 1/2 Tons  
181 = 15 Tons  
211 = 17 1/2 Tons  
241 = 20 Tons  
301 = 25 Tons

### Major Design Change

F = Impack - Side by Side - Ft. Smith Only  
B = Over/Under - Ft. Smith Only  
G = Impack Plus - Side by Side - Ft. Smith Only

### Electrical Characteristics

1 = 208-230/1/60  
3 = 208-230/3/60  
4 = 460/3/60

### Secondary Capacity And/Or Factory-Installed Options

00 = No Heat, No Options  
LO = Low Heating Capacity  
MO = Medium Heating Capacity  
HO = High Heating Capacity

### Minor Design Change

**Service Digit - Not Orderable**

# Model Nomenclature Residential

## Controls

1 2 3 4 5 6 7 8 9 10 11 12 13 14 15  
A Z O N E 9 5 0 A C 5 2 Z A A

**Brand**

A = American Standard  
Z = Unbranded

**Accessory Type**

CONT = Control (thermostat)  
ZONE = Control (zoning)

**Model Series**

**Major Design Modifications**

**Control Platform**

M = Mechanical  
N = Non-programmable Electronic (Digital Display)  
F = Five/Two Programmable Electronic (Digital Display)  
S = Seven Day Programmable Electronic (Digital Display)  
C = Communicating  
W = Wireless

**Heating Stages**

**Cooling Stages**

**Equipment Application**

A = AC / Heat (Gas or Electric)  
G = AC / Heat (Gas)  
E = AC / Heat (Electric)  
H = Heat Pump  
M = Multi-Application - AC / Heat (Gas/Elec) / Heat Pump  
D = Dual Fuel, Heat Pump, or AC and Heat (Gas/Elec)  
C = Communicating  
Z = Zoning - Universal application - 3 wire Communicating zone control of AC or Heat (Gas/Elec) and Dual Fuel Heat Pump  
U = Universal Application - Communicating Control of AC/Heat (Gas/Elec) / Dual Fuel Heat Pump

**Minor Design Change**

**Service Digit**

## Zone Dampers

1 2 3 4 5 6 7 8 9 10 11 12 13 14 15  
Z D A M P R D M A 0 0 1 2 A A

**Brand**

Z = Zoning

**Damper**

**Model Series**

RD = Round  
RR = Retro-Fit Round  
SM = Side Mount Rectangular  
BM = Bottom Mount Rectangular

**Modulating Damper (24 Volt, 60 Sec. Timing)**

**Major Design Modifications**

**Dimensions**

0012 = 12" Round  
1014 = 10" X 14" Rectangular (motor mounted on 2nd dimension)

**Minor Design Change**

**Service Digit**

ONLINE ONLY COPY

# Conventional 24 Volt Smart Thermostat

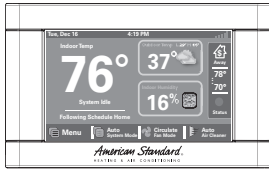

**GOLD 824  
ACONT824AS52DB**



## ACONT824AS52DB

- Energy Star<sup>®</sup> certified
- Built-in Z-Wave Bridge ①
- WiFi or Ethernet connection
- Control from a smartphone, tablet, or computer ①②
- 4.3" diagonal color touchscreen
- 7 Day programmable with up to four schedules per day
- Five day weather forecast, weather radar, and weather alerts ①
- Indoor relative humidity display
- Enhanced dehumidification (cooling)
- 2 Auxiliary dry contacts control 2 of the following: Whole house humidifier, dehumidifier, or ventilation system
- Test modes and alert diagnostics
- Screen access restrictions
- American Standard Diagnostics ①
- Over-the-air software upgrade ①
- Local software upgrade option
- Silver color
- Limited Warranty: 5 yr. base/10 yr.

## Application:

- Conventional gas/electric, heat pump, and dual fuel systems
- Conventional boiler systems (forced air only)
- Conventional HVAC systems:
- 2 Heat / 2 cool
- Heat Pump systems: Up to 5 stages heat / 2 stages cool (2 compressor heat - 3 auxiliary heat / 2 cooling)
- Heat Pump switchover valve: selectable "with cool or with heat"
- Remote wired indoor temperature sensor (optional) ZZSENSAL0400AA
- Remote wireless indoor temperature and humidity sensor (optional): ZSENS930AW00MA
- Remote wired outdoor temperature sensor (optional) BAYSEN01ATEMPA
- PWM Circuit (BK terminal): controls indoor unit variable speed blower
- Wall cover plate BAYCOVR800A

## Dimensions:

- Product: 5.43"w x 3.39"h x 1.30"d
- Display: 4.15"w x 2.65"h

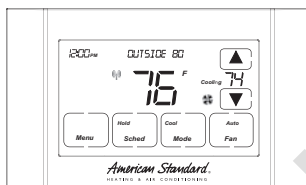

**SILVER 724  
ACONT724AS42DA**



## ACONT724AS42DA

- American Standard<sup>®</sup> Home compatible ①②
- American Standard Diagnostics ①
- WiFi connectivity
- Control from a smartphone, tablet, or computer ①②
- 4.3" diagonal black and white touchscreen
- 7 Day programmable with up to 4 schedules per day
- Humidity sensor and RH display
- Remote temperature sensor connections (1 indoor/1 outdoor)
- Auxiliary & compressor heat lockouts
- Auxiliary dry contact
- Enhanced dehumidification (cooling)
- PWM Circuit (BK terminal): controls indoor unit variable speed blower
- Energy Savings Mode (ESM)
- Screen lock and guest lock
- Service test modes
- Upgradable software
- Color: Designer Silver
- Limited Warranty: 1 yr. base/5 yr.

## Application:

- Up to 4 Stages Heat/2 Stages Cool
- Conventional gas/electric, heat pump, and dual fuel systems
- Conventional boiler systems (baseboard & radiators)
- Remote wired indoor temperature sensor (optional): ZZSENSAL0400AA
- Remote wired outdoor temperature sensor (optional): BAYSEN01ATEMPA
- Wall cover plate BAYCOVR800A
- Z-Wave Bridge is required to control Z-Wave devices. ①②

## Dimensions:

- Product: 5.9"w x 3.47"h x .95"d
- Display: 3.8"w x 2.3"h

① Requires internet service and American Standard<sup>®</sup> Home smart home system registration.  
② American Standard<sup>®</sup> Home remote climate access is included with the purchase for up to 8 Connected Controls per home. Adding accessories or additional controls to your American Standard<sup>®</sup> Home system may require a monthly subscription.

BUILT TO A HIGHER STANDARD<sup>®</sup>

**American Standard**<sup>®</sup>  
HEATING & AIR CONDITIONING

## AccuLink™ Communicating Smart Thermostat

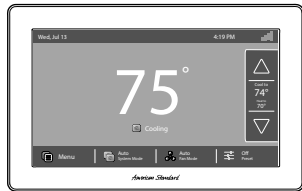

**PLATINUM 1050  
AZON1050AC52ZA**



### AZON1050AC52ZA

- Mobile app compatible with built-in Z-Wave bridge (download American Standard Home mobile app)
- American Standard Diagnostics ①
- WiFi or Ethernet connection
- Control from a smartphone, tablet, or computer ①②
- 7" diagonal color touchscreen
- 1-Touch Presets - Home, Away, Sleep
- 7 Day programmable with up to four schedules per day
- Customizable Home Screen
- Runtime History
- Allergy and Quick Clean Air Cycles
- Smart Continuous Fan
- Adjustable Continuous Airflow (35-100%)
- Screen access restrictions
- Dealer Contact Widget
- Service, Filter, Humidifier, UV Light, Air Cleaner Reminders
- Five day weather forecast, weather radar, and weather alerts ①
- Indoor relative humidity display
- Test modes and alert diagnostics
- Over-the-air Software Upgrade ①
- Local Software Upgrade option
- Color: Designer Silver
- Limited Warranty: 5 yr. base/10 yr.

### Application:

- **AccuComfort™** Variable Speed
- **AccuLink™ II** Two Stage Systems
- **AccuLink™ II** Zoning Systems
- **AccuComfort™** Variable speed outdoor cooling or heat pump unit combined with S-Series non-communicating variable speed furnace and "C" model Relay Panel
- Relay panel (BAY24VRP52DC) is required when applied with conventional systems (Gas Electric, Heat Pump, Dual Fuel, Boilers - forced air only)
- Relay Panel Supports:
  - Up to 5 stages heat, 2 stages cool
  - Connections for Remote indoor and outdoor temperature sensors
  - 3 Dry Auxiliary Contacts to control whole house humidifier, dehumidifier, or ventilation system
- Remote wired indoor temperature sensor (optional) ZZSENSAL0400AA
- Remote wireless indoor temperature and humidity sensor (optional): ZSENS930AW00MA
- Remote wired outdoor temperature sensor (optional) BAYSEN01ATEMPA

### Dimensions:

- Product: 7.2"w x 4.5"h x 1.2"d
- Display: 6.1"w x 3.3"h

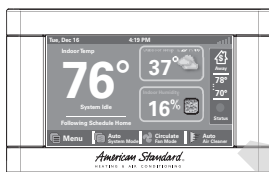

**PLATINUM 850  
ACONT850AC52UB**



### ACONT850AC52UB

- Mobile app compatible with built-in Z-Wave bridge (download American Standard Home mobile app)
- WiFi (802.11 b/g/n) or Ethernet connection
- Control from a smartphone, tablet, or computer ①②
- 4.3" diagonal color touchscreen
- Compatible with AccuLink™ communicating systems (variable speed and two stage)
- Compatible with conventional 24 volt HVAC, heating, heat pump, and dual fuel systems when used with accessory relay panel model BAY24VRPAC52DB
- 7 Day programmable with up to six schedules per day
- Five day weather forecast, weather radar, and weather alerts ①
- Indoor relative humidity display
- Test modes and alert diagnostics
- American Standard Diagnostics
- Upgradable software
- Silver color
- Wall Cover Plate BAYCOVR800A
- Limited Warranty: 5 yr. base/10 yr.

### Application:

- **AccuLink™** communicating systems (variable speed and two stage)
- Variable speed outdoor cooling combined with S-Series non-communicating variable speed furnace and "C" model Relay Panel
- Conventional gas/electric, heat pump, dual fuel systems, or boiler systems (forced air only) with use of relay panel model BAY24VRPAC52DB. Relay panel controls up to 5 stages heat, 2 stages cool, remote indoor and outdoor connections, humidifier, dehumidifier, and ventilation system.
- Remote wired indoor temperature sensor (optional) ZZSENSAL0400AA
- Remote wireless indoor temperature and humidity sensor (optional): ZSENS930AW00MA
- Remote wired outdoor temperature sensor (optional) BAYSEN01ATEMPA

### Dimensions:

- Product: 5.43"w x 3.39"h x 1.30"d
- Display: 4.15"w x 2.65"h

- ① Requires internet service and connection to American Standard<sup>®</sup> Home smart home system.  
② American Standard<sup>®</sup> Home remote climate access is included with the purchase of up to 8 Connected Controls per home. Adding accessories to your American Standard<sup>®</sup> Home system may require a monthly subscription for remote access via most web-enabled smartphones, tablets and computers.

For complete equipment / combination selections, installation instructions and warranty information, please refer to Product Data/Ratings and/or Installers Guides and Limited Warranty Handbooks.



# American Standard<sup>®</sup> Home Compatible Products

## Remote Temperature Sensor

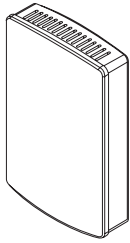

Remote Wireless Indoor Sensor

### ZSENS930AW00MA

- Indoor Wireless Temperature and Humidity Sensor for use with ACONT824, ACONT850, AZON1050
- Operating Ambient Temperature Range: 32° to 104°F (0° to 40°C)
- Power Supply: Two AAA alkaline batteries
- Sensor Accuracy: +/-1°F over the sensing range of 32°F to 120°F (0° to 48.9°C)
- Operating Relative Humidity: 10% to 90% non-condensing
- Enables RoomIQ™ access in American Standard Home mobile app

### Dimensions in in. (mm):

- 2.0" (51)w x 3.25" (83)h x .6 (15)d
- Storage Temperature: -40° to 140°F (-40° to 65°C)
- Finish: White

## Modules



Smart Energy Switch

### Smart Energy Switch

SKU: 811097020464

- Z-Wave plus Smart Energy Switch with single switched outlet
- Can be scheduled or remote controlled via American Standard Home app on smartphone/tablet
- Physical button allows manual switch control
- Built-in Z-Wave repeater to extend wireless range up to 250ft
- Monitors energy consumption of plugged-in device and provides instant power and accumulated power consumption reports via American Standard Home app
- Plugs into any standard 120VAC outlet. Provides over voltage/current protection.
- For indoor use only

### Application:

- Protocol: Z-Wave
- Manufacturer: American Standard Home
- Max load: 400W incandescent, 15A resistive, 120VAC
- Operating Temperature: 32-104°F

### Unit Dimensions:

- 2.2"w x 2.2"d x 2.4"h
- Shipping weight: 1 lb.

### Warranty

- 1-Year Limited Warranty

BUILT TO A HIGHER STANDARD<sup>®</sup>

**American Standard<sup>®</sup>**  
HEATING & AIR CONDITIONING

## American Standard<sup>®</sup> Home Compatible Products

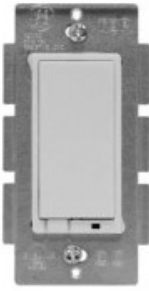

**Jasco In-Wall Dimmer Switch**

### Dimmer Switch

SKU: 043180457127

- Turn light on/off or dim any incandescent lighting remotely from American Standard<sup>®</sup> Home app ①
- Interchangeable paddles; white and light almond included in package (wall plate not included)
- Easy to install; includes space-saving screw terminals
- Automate with American Standard<sup>®</sup> Home based on time of day
- Trigger actions from other smart products
- LED indicator glows in dark

### Application:

- Protocol: Z-Wave
- Power: 120 VAC, 60Hz
- Max Load: 1000W, 2-gang 800W and 3-gang 600W
- Operating Temperature: 0°C-40°C
- Indoor Use Only
- Specifications subject to change without notice

### Warranty

- 1-Year Limited Warranty

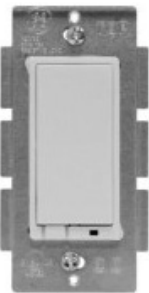

**Jasco In-Wall On/Off Switch**

### On/Off Switch

SKU: 043180457097

- Turn any light on/off remotely from American Standard<sup>®</sup> Home app ①
- Interchangeable paddles; white and light almond included in package (wall plate not included)
- Easy to install; includes space-saving screw terminals
- Automate with American Standard<sup>®</sup> Home based on time of day
- Trigger actions from other smart products
- LED indicator glows in dark

### Application:

- Protocol: Z-Wave
- Power: 120 VAC, 60Hz
- Max Load: 960W Incandescent, 1/2 HP Motor, 1800W (15A) Resistive
- Operating Temperature: 0°C-40°C
- Indoor Use Only
- Specifications subject to change without notice

### Warranty

- 1-Year Limited Warranty



**Jasco In-Wall 3-Way Add-on Switch**

### 3-Way Add-on Switch

SKU: 030878465601

- The Jasco Add-On Switch mirrors the functionality of the Jasco switch with which it is paired. Unlike traditional lighting controls, all paired switches perform the same functions. ①
- Compatible with all In-Wall GE and Jasco Switches, Dimmers and Fan Controls
- Required for use with 3- and 4-way wiring
- Interchangeable paddles; white and light almond included in package (wall plate not included)
- Easy to install; includes space-saving screw terminals

### Application:

- Power: 120 VAC, 60Hz
- Operating Temperature: 0°C-40°C
- Indoor Use Only
- Specifications subject to change without notice

### Warranty

- 1-Year Limited Warranty

For complete equipment / combination selections, installation instructions and warranty information, please refer to Product Data/Ratings and/or Installers Guides and Limited Warranty Handbooks.

# American Standard® Home Compatible Products



**GE In-Wall Fan Control Switch**

**Fan Control Switch**

SKU: 030878143141

SKU: 030878127301 (Phasing out)

- Turn fan on/off and control up to three speed levels remotely from American Standard® Home app
- Interchangeable paddles; white and light almond included in package (wall plate not included)
- Easy to install; includes space-saving screw terminals and neutral jumper wires
- Automate with American Standard® Home based on temperature (with Z-Wave temperature sensor) or time of day
- Trigger actions from other smart products
- LED indicator glows in dark

**Application:**

- Protocol: Z-Wave
- Power: 120 VAC, 60Hz
- Max Load: 1.5A no more than two identical fans per switch not to exceed 1.5A resistive load - Controls Fan Motor Only - for use with split capacitor or shaded pole ceiling fan motors
- Operating Temperature: 0°C-40°C
- Indoor Use Only
- Specifications subject to change without notice



**JASCO In-Wall Smart Motion Switch**

**In-Wall Smart Motion Switch**

SKU: 030878247702

- Indoor in-wall Z-Wave light switch with integrated motion sensor
- Wirelessly trigger scenes/automations and send alerts to smartphone or tablet when motion detection has turned lights on or off.
- Can be used in 3-way and 4-way applications
- Multiple Operation Modes:
  - Occupancy - auto ON/auto OFF
  - Vacancy - manual ON/auto OFF
  - Manual - manual ON/OFF
- 3 Sensitivity Levels - low, medium, high
- Requires in-wall installation with hard-wired connections - Neutral wire REQUIRED.
- Includes white and light almond paddles (wall plate not included)

**Application:**

- Protocol: Z-Wave
- Manufacturer: JASCO
- Max load: 960W incandescent, ½ HP motor, 1800W, 120VAC
- Operating Temperature: 32-104°F

**Unit Dimensions:**

- 1.5"w x 1.5"d x 3.0"h

**Warranty**

- 1-Year Limited Warranty

BUILT TO A HIGHER STANDARD<sup>®</sup>

**American Standard<sup>®</sup>**  
HEATING & AIR CONDITIONING

# American Standard<sup>®</sup> Home Compatible Products

## Security Sensors & Alarms

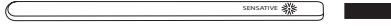

**Sensative Strips Door/  
Window Sensor**

**Sensative Strips Door/Window Sensor**  
SKU: 7350088520024

- Ultra thin design (less than 3 mm ) for invisible mounting between most doors/windows and their frames
- Simple to set up with the included adhesive backing
- Indoor or outdoor use
- Not for use on metal surfaces which may block the signal
- Long lasting non-replaceable battery (10 year life)

**Application:**

- Protocol: Z-Wave
- Manufacturer: Sensative

**Application:**

- Indoor Range: 130 ft.
- Magnetic Range: 0.6"
- Operating Temperature: -4°F-140°F (-20°C-60°C)

**Dimensions:**

- Sensor: 7.7"l x 0.6"w x 0.12"d
- Magnet: 1.2"l x 0.43"w x 0.04"d
- Weight: 2 oz.

**Warranty**

- 1-Year Limited Warranty



**Outdoor Module**

**Outdoor Module**

SKU: 030878142847

- Wirelessly schedule and control outdoor lighting and appliances, including seasonal and landscape lighting, fountains and pumps from anywhere
- Contains one Z-Wave outlet and a manual switch for On/Off control
- Weather and impact resistant enclosure
- Built-in mounting bracket

**Application:**

- Protocol: Z-Wave
- Max load: 600W incandescent, ½ HP motor, 120VAC
- Operating Temperature: 32-104°F

**Dimensions:**

- 5.5"h x 4.0"w x 2.5"d

**Warranty**

- 1-Year Limited

# American Standard<sup>®</sup> Home Compatible Products

## FortrezZ Water Valves

### Indoor Actuator



Indoor Actuator  
SKU: 045635411890

- Indoor Actuator
- Remotely operated Z-Wave water valve compatible with American Standard<sup>®</sup> Home smart home systems ①
- Automatically turns off main water supply when a water event is detected
- Select 3/4", 1", or 1-1/4" brass water valve for use with indoor actuator

- Can be used as irrigation device
- Multiple valves can be used and programmed in a Z-Wave Network
- Meets the standard of most state and municipal authorities
- Two tactile switches to manually activate the valve
- Ask insurance company for specific details about premium discounts for flood protection

### Outdoor actuator



Outdoor Water Valve Variants  
SKU: 661799563260  
Outdoor actuator and indoor control with 50' cable ②③

### Brass Water Valves



Brass Ball Water Valves  
SKU: 045635411852  
3/4" Brass Valve ④

① Requires internet service and American Standard<sup>®</sup> Home smart home system registration.  
② Used with brass ball valves (ordered separately)  
③ For applications that require outside installation above or below grade with temporary submersion at limited depth. See installation instructions for details.  
④ Used with outdoor water valve variant (ordered separately)

BUILT TO A HIGHER STANDARD™

**American Standard**  
HEATING & AIR CONDITIONING

# AccuComfort™ Variable Speed Cooling Single Phase – 2-5 Tons



**Platinum 20  
(Variable Speed)**

**Table SC-1-A — Platinum 20 R-410A AccuComfort™ Variable Speed Cooling (30–100% capacity)—with AccuLink™ ①**

Model Number	Power Supply	Nom. Cap. Cooling (BTUH)	Uncrated Dimensions (in.)			Shipping Weight (lbs.)	Sound** Rating	MCA*	Max. Fuse*	Line Size (in)	
			H	W	D					OD Gas	OD Liq.
4A7V0X24A1000A	208/230/1/60	24,000	41	33	30	217	66	17.0	25	3/4	3/8
4A7V0X36A1000A	208/230/1/60	36,000	41	37	34	248	70	18.0	25	3/4	3/8
4A7V0X48A1000A	208/230/1/60	48,000	41	37	34	270	74	23.0	35	7/8	3/8
4A7V0X60A1000A	208/230/1/60	54,000	45	37	34	284	75	27.0	40	7/8	3/8
4A7V0X61A1000A	208/230/1/60	54,000	45	37	34	314	75	27.0	40	7/8	3/8



**Platinum 18  
(Variable Speed)**

**Table SC-1-B — Platinum 18 R-410A AccuComfort™ Variable Speed Cooling (30–100% capacity)—with AccuLink™ ①**

Model Number	Power Supply	Nom. Cap. Cooling (BTUH)	Uncrated Dimensions (in.)			Shipping Weight (lbs.)	Sound** Rating	MCA*	Max. Fuse*	Line Size (in)	
			H	W	D					OD Gas	OD Liq.
4A7V8X24A1000A	208/230/1/60	24,000	41	33	30	217	66	17.0	25	3/4	3/8
4A7V8X36A1000A	208/230/1/60	36,000	41	33	30	228	70	18.0	25	3/4	3/8
4A7V8X48A1000A	208/230/1/60	48,000	41	37	34	270	74	23.0	35	7/8	3/8
4A7V8X60A1000A	208/230/1/60	54,000	45	37	34	284	75	27.0	40	7/8	3/8

① Must use ACONT850, AZONE950 or AZON1050 control.

\* Information subject to change. Please confirm with current Product Data/Service Facts for current factory production.

\*\* Rated in accordance with AHRI Standard 270-2008 (Min/Max when applicable).

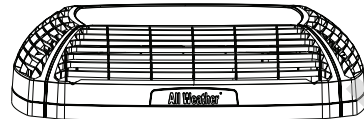

### ALL WEATHER™ TOP ACCESSORY

BAYAWGR0003 - Fits base sizes 33"x30" (WxD)

BAYAWGR0004 - Fits base sizes 37"x34" (WxD)

Split System Cooling

# AccuComfort™ Variable Speed Cooling Single Phase – 2-5 Tons

Split System Cooling

**Table SC-2-A — Features**

	Platinum 20 (4A7V0)	Platinum 18 (4A7V8)
• SEER up to .....	22.00	18.00
• <b>Climatuff™</b> compressor .....	1	1
• Number of stages .....	Variable	Variable
• <b>Comfort-R™</b> mode approved .....	✓	✓
• <b>AccuLink™</b> system .....	✓	✓
• <b>DuraBase™</b> base, fast complete drain, weatherproof .....	✓	✓
• <b>Quick-Sess™</b> cabinet, service access & refrigerant connections with full coil protection .....	✓	✓
• <b>Spine Fin™</b> coil .....	✓	✓
• Compressor sound enclosure .....	✓	✓
• Compressor sump heat .....	✓	✓
• Factory supplied charge .....	R-410A	R-410A
• Glossy corrosion resistant finish .....	✓	✓
• High pressure switch .....	✓	✓
• Low pressure switch .....	✓	✓
• Internal high / low pressure & temperature protection .....	✓	✓
• Liquid line filter drier - factory installed or factory supplied for field install .....	✓	✓
• Seacoast shield - factory installed .....	✓	✓
• Spinnaker gray cabinet .....	✓	✓
• <b>12-year limited warranty on compressor, 10-year on outdoor coil &amp; all other functional parts with registration* (Residential Use)</b> .....	✓	✓
• <b>Extended warranties available</b> .....	✓	✓

\* Registered Limited Warranty terms are available when you register within 60 days of installation. You can register online at americanstandardair.com or by phone at 855-260-2975, otherwise American Standard Heating & Air Conditioning's Base Limited Warranty terms will apply. Base Limited Warranty information on specific products can be found on ASDealerNet.com.

**Table SC-2-B — Optional Accessories**

Model Number	Description	Shipping Weight		
BAYECMT023	Extreme Conditions Mounting Kit (Base 2/3)	2	2	2-3
BAYECMT004	Extreme Conditions Mounting Kit (Base 4)	2	3-5	048-60
BAYISLT101	Rubber Isolators	1	✓	✓
BAYVEN002	Enhanced Sound Enclosure	2	✓	✓
BAYLEGS007	Snow Legs - 7" High (Black)	1	✓	✓
BAYLEGS004	Snow Legs - 4" High (Black)	1	✓	✓
BAYVDTA003	Vertical Discharge Air Kit Base 3	10	2	—
BAYVDTA004	Vertical Discharge Air Kit Base 4	10	3-5	—
BAYSEAC001	Seacoast Kit	1	—	✓
PAI00309 <sup>Ⓞ</sup>	Heresite Spraypaint	1	✓	✓
BAYSEN01ATEMPA	External Ambient Kit		✓	✓
BAYTWGR0004	<b>WEATHERGUARD™</b> Top - Fits unit base size of (W x D) of 37" X 34"		—	048-060
BAYTWGR0003	<b>WEATHERGUARD™</b> Top - Fits unit base size of (W x D) of 33" X 30"		—	024-036
BAYECC001	Extreme Coastal Conditions Kit*		✓	✓

\* Not for use in Arizona or other extreme heat applications.

**Comfort Controls — See Comfort Controls/Zone Sensors Section**

<sup>Ⓞ</sup> Used for additional seacoast corrosion protection. Refer to bulletin number UN-SVB11A-EN for application information.

# Split System Cooling Single Phase – 1½-5 Tons

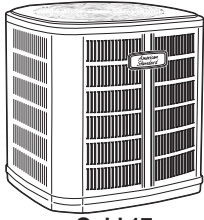

**Gold 17  
(Two Stage)**

**Table SC-3-A — Gold 17 R-410A Split System Two Stage Cooling (70/100% capacity)**

Model Number	Power Supply	Nom. Cap. Cooling (BTUH)	Uncrated Dimensions (in.)			Shipping Weight (lbs.)	Sound** Rating	MCA*	Max. Fuse*	Line Size (in)	
			H	W	D					OD Gas	OD Liq.
4A7A7024A1000C	208/230/1/60	24,000	41	37	34	280	72	13.4	20	¾	⅜
4A7A7036A1000C	208/230/1/60	36,000	45	37	34	288	72	18.4	30	¾	⅜
4A7A7048B1000A	208/230/1/60	48,000	45	37	34	296	73	28.0	45	⅞	⅜
4A7A7060A1000B	208/230/1/60	54,000	45	37	34	312	74	35.0	60	⅞	⅜

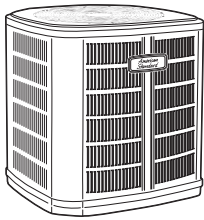

**Silver 16  
(Single Stage)**

**Table SC-3-B — Silver 16 R-410A Split System Single Stage Cooling**

Model Number	Power Supply	Nom. Cap. Cooling (BTUH)	Uncrated Dimensions (in.)			Shipping Weight (lbs.)	Sound** Rating	MCA*	Max. Fuse*	Line Size (in)	
			H	W	D					OD Gas	OD Liq.
4A7A6018J1000A	208/230/1/60	18,000	29	33	30	189	73	12.0	20	¾	⅜
4A7A6024J1000B	208/230/1/60	24,000	29	33	30	190	73	13.0	20	¾	⅜
4A7A6030J1000B	208/230/1/60	30,000	37	33	30	220	73	14.0	25	¾	⅜
4A7A6036J1000A	208/230/1/60	36,000	37	37	34	246	71	18.0	30	¾	⅜
4A7A6042J1000A	208/230/1/60	42,000	45	37	34	302	72	21.0	35	⅞	⅜
4A7A6048J1000A	208/230/1/60	48,000	45	37	34	306	72	24.0	40	⅞	⅜
4A7A6049J1000A	208/230/1/60	48,000	45	37	34	322	72	26.0	40	⅞	⅜
4A7A6060J1000B	208/230/1/60	54,000	45	37	34	327	72	27.0	45	⅞	⅜
4A7A6061J1000B	208/230/1/60	54,000	45	37	34	317	74	29.0	45	⅞	⅜

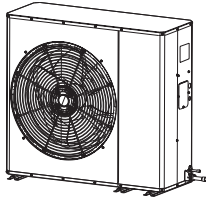

**Silver 16  
(Single Stage)**

**Table SC-3-C — Silver 16 R-410A Side Discharge Single Stage Cooling**

Model Number	Power Supply	Nom. Cap. Cooling (BTUH)	Uncrated Dimensions (in.)			Shipping Weight (lbs.)	Sound** Rating	MCA*	Max. Fuse*	Line Size (in)	
			H	W	D					OD Gas	OD Liq.
4A7L6018A1000A①	208/230/1/60	18,000	37	40	15	165	70	12.0	20	¾	⅜
4A7L6024A1000A①	208/230/1/60	24,000	37	40	15	165	70	13.0	20	¾	⅜
4A7L6030A1000A①	208/230/1/60	30,000	37	40	15	180	71	17.0	25	¾	⅜
4A7L6036A1000A①	208/230/1/60	36,000	37	47	18	242	72	19.0	30	¾	⅜
4A7L6042A1000A①	208/230/1/60	42,000	37	47	18	243	73	22.0	35	⅞	⅜
4A7L6048A1000A①	208/230/1/60	48,000	37	47	18	243	73	24.0	40	⅞	⅜
4A7L6060A1000A①	208/230/1/60	54,000	43	47	18	263	73	31.0	50	⅞	⅜

① For coastal applications where units are installed within one (1) mile of salt water, epoxy coated models are available for order. Model numbers with "COT" in the eleventh (11) through thirteenth (13) digits represent an epoxy coated coil. Example: 4A7L6036A1COTA These models have an 8 week lead time after order.

\* Information subject to change. Please confirm with current Product Data/Service Facts for current factory production.

\*\* Rated in accordance with AHRI Standard 270-2008 (Min/Max when applicable).



# Split System Cooling Single Phase - 1½-5 Tons

Split System Cooling

**Table SC-4-A — Features**

	Gold 17 (4A7A7)	Silver 16 (4A7A6)	Silver16 (4A7L6)
• SEER up to .....	18.00	17.00	17.00
• <b>Duration™</b> compressor .....	✓	✓	✓
• Number of stages .....	2	1	1
• <b>Comfort-R™</b> mode approved .....	✓	✓	✓
• <b>DuraBase™</b> base, fast complete drain, weatherproof .....	✓	✓	—
• <b>Easy-Sess™</b> cabinet, service access .....	✓	✓	—
• <b>Spine Fin™</b> coil .....	✓	✓	—
• <b>Coppe Tube, Aluminum Fin</b> coil .....	—	—	✓
• Factory supplied charge .....	R-410A	R-410A	R-410A
• Glossy corrosion resistant finish .....	✓	✓	✓
• High pressure switch .....	✓	✓	✓
• Internal high / low pressure & temperature protection .....	✓	✓	✓
• Liquid line filter drier - factory installed or factory supplied for field install .....	✓	✓	✓
• Quick start kit-factory installed .....	—	1½-2	—
• Spinnaker gray cabinet .....	✓	✓	✓
• <b>12-year limited warranty on compressor,10-year on outdoor coil &amp; all other functional parts (Residential Use)</b> .....	✓	—	—
• <b>10-year limited warranty on compressor,10-year on outdoor coil &amp; all other functional parts (Residential Use)</b> .....	—	✓	✓
• <b>Extended warranties available</b> .....	✓	✓	✓

\* Registered Limited Warranty terms are available when you register within 60 days of installation. You can register online at americanstandardair.com or by phone at 855-260-2975, otherwise American Standard Heating & Air Conditioning's Base Limited Warranty terms will apply. Base Limited Warranty information on specific products can be found on ASDealerNet.com.

**Table SC-4-B — Optional Accessories**

Model Number	Description	Shipping Weight			
AY28X079.....	Evap. Defrost Control Kit .....	1.....	✓	✓	✓
BAYCCHT301RES.....	Crankcase Heater Kit (Scroll).....	1.....	4-5	3½-5	3½-5
BAYCCHT302RES.....	Crankcase Heater Kit (Scroll).....	1.....	2-3	1½-3	1½-3
BAYECMT023.....	Extreme Conditions Mounting Kit (Base 2/3).....	2.....	—	1½-2½	—
BAYECMT004.....	Extreme Conditions Mounting Kit (Base 4).....	2.....	✓	3-5	—
BAYISLT101.....	Rubber Isolators.....	1.....	✓	✓	✓
BAYKSKT263.....	Start kit.....	1.....	2-3	2½-5	2½-5
BAYKSKT266.....	Start kit.....	1.....	4-5	—	—
BAYLEGS007.....	Snow Legs - 7" High (Black).....	1.....	✓	✓	✓
BAYLEGS004.....	Snow Legs - 4" High (Black).....	1.....	✓	✓	✓
BAYLOAM107A.....	Low Ambient Kit.....	1.....	✓	✓	✓
BAYSDEN001.....	Small Scroll Compressor Enclosure.....	8.....	—	1½-2	—
BAYSDEN004.....	Large Scroll Compressor Enclosure.....	8.....	—	2½-5	1½-5
BAYSEAC001.....	Seacoast Kit.....	1.....	✓	✓	—
BAYSDHG002A.....	Hail Guard Kit.....	5.....	—	—	1½-2½
BAYSDHG003A.....	Hail Guard Kit.....	5.....	—	—	3-4
BAYSDHG004A.....	Hail Guard Kit.....	5.....	—	—	5
BAYWIND102.....	Wind Baffle Kit.....	—.....	—	—	5
BAYWIND103.....	Wind Baffle Kit.....	—.....	—	—	3-5
TAYASCT501A①②.....	Anti-Short Cycle Timer.....	2.....	✓	✓	—
AAYSVPANL0032AA.....	Service Valve Panel Cover Kit.....	2.....	—	1½-2	—
AAYSVPANL3343AA.....	Service Valve Panel Cover Kit.....	2.....	2	—	—
AAYSVPANL0044AA.....	Service Valve Panel Cover Kit.....	2.....	3-5	2½-3	—
AAYSVPANL0046AA.....	Service Valve Panel Cover Kit.....	2.....	—	3½-5	—
PAI00309③.....	Heresite Spraypaint.....	1.....	✓	✓	✓
BAYAWGR0004.....	<b>All Weather™ Top</b> - Fits unit base size of (W x D) of 37" X 34".....	—.....	✓	036-061	—
BAYAWGR0003.....	<b>All Weather™ Top</b> - Fits unit base size of (W x D) of 33" X 30".....	—.....	—	018-030	—
BAYSDHG001A.....	Hail Guard Kit 3.2.....	—.....	—	—	✓
BAYSDHG002A.....	Hail Guard Kit 3.3.....	—.....	—	—	✓
BAYSDHG003A.....	Hail Guard Kit 4.3.....	—.....	—	—	✓
BAYSDHG004A.....	Hail Guard Kit 4.4.....	—.....	—	—	✓

**Comfort Controls — See Comfort Controls/Zone Sensors Section**

- ① Not for use with programmable thermostats.
- ② Activated on power off.
- ③ Used for additional seacoast corrosion protection. Refer to bulletin number UN-SVB11A-EN for application information.
- ④ Available from Trane Parts.

For complete equipment / combination selections, installation instructions and warranty information, please refer to Product Data/Ratings and/or Installers Guides and Limited Warranty Handbooks.

# Split System Cooling Single Phase - 1½-5 Tons

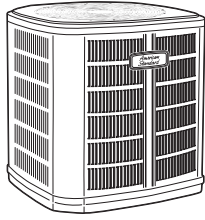

**Silver 14  
(Single Stage)**

**Table SC-5-A — Silver 14 R-410A Split System Single Stage Cooling**

Model Number	Power Supply	Nom. Cap. Cooling (BTUH)	Uncrated Dimensions (in.)			Shipping Weight (lbs.)	Sound** Rating	MCA*	Max. Fuse*	Line Size (in)	
			H	W	D					OD Gas	OD Liq.
4A7A4018L1000A	208/230/1/60	18,000	29	29	26	153	71	12.0	20	3/4	3/8
4A7A4024L1000B①	208/230/1/60	24,000	29	29	26	153	71	14.0	20	3/4	3/8
4A7A4025L1000B	208/230/1/60	24,000	29	29	26	153	71	14.0	20	3/4	3/8
4A7A4030L1000B①	208/230/1/60	30,000	29	33	30	183	71	14.0	25	3/4	3/8
4A7A4031L1000B	208/230/1/60	30,000	29	33	30	183	71	14.0	25	3/4	3/8
4A7A4036L1000B①	208/230/1/60	36,000	33	33	30	183	71	18.0	30	3/4	3/8
4A7A4037L1000B	208/230/1/60	36,000	33	33	30	183	71	18.0	30	3/4	3/8
4A7A4042L1000A①	208/230/1/60	42,000	29	37	34	216	71	22.0	35	7/8	3/8
4A7A4043L1000A	208/230/1/60	42,000	29	37	34	216	71	22.0	35	7/8	3/8
4A7A4048L1000A	208/230/1/60	48,000	29	37	34	221	71	24.0	40	7/8	3/8
4A7A4060L1000B	208/230/1/60	54,000	37	37	34	246	71	27.0	45	7/8	3/8

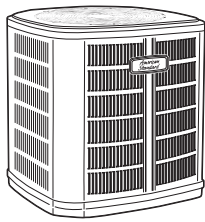

**Silver 13  
(Single Stage)**

**Table SC-5-B— Silver 13 R-410A Split System Single Stage Cooling**

Model Number	Power Supply	Nom. Cap. Cooling (BTUH)	Uncrated Dimensions (in.)			Shipping Weight (lbs.)	Sound** Rating	MCA*	Max. Fuse*	Line Size (in)	
			H	W	D					OD Gas	OD Liq.
4A7A3018H1000N②	208/230/1/60	18,000	29	29	26	153	72	12.0	20	3/4	3/8
4A7A3024H1000P②	208/230/1/60	24,000	29	29	26	150	74	14.0	20	3/4	3/8
4A7A3030H1000N②	208/230/1/60	30,000	29	29	26	157	72	16.0	25	3/4	3/8
4A7A3036H1000P②	208/230/1/60	36,000	29	33	30	175	68	20.0	35	3/4	3/8
4A7A3042E1000N②	208/230/1/60	42,000	29	33	30	200	72	22.0	35	7/8	3/8
4A7A3043A1000N②	208/230/1/60	42,000	29	37	34	216	72	22.0	35	7/8	3/8
4A7A3048E1000P②	208/230/1/60	48,000	37	33	30	233	74	28.0	45	7/8	3/8
4A7A3049A1000N②	208/230/1/60	48,000	29	37	34	221	74	24.0	40	7/8	3/8
4A7A3060E1000N②	208/230/1/60	54,000	37	37	34	246	71	27.0	45	7/8	3/8

① Models are not legal for installation in California, Nevada, New Mexico and Arizona. All other models are legal for installation in all US zones and states.

② 13 SEER AC equipment manufactured after 1/1/16 can only be installed in the North Zone.

\* Information subject to change. Please confirm with current Product Data/Service Facts for current factory production.

\*\* Rated in accordance with AHRI Standard 270-2008 (Min/Max when applicable).

# Split System Cooling Single Phase – 1½-5 Tons

Split System Cooling

**Table SC-6-A — Features**

	Silver 14 (4A7A4)	Silver 13 (4A7A3)
SEER up to.....	16.00	14.75
Duration™ compressor.....	✓	✓
Number of stages.....	1	1
Comfort-R™ mode approved.....	✓	✓
DuraBase™ base, fast complete drain, weatherproof.....	✓	✓
Easy-Sess™ cabinet, service access.....	✓	✓
Spine Fin™ coil.....	✓	✓
Factory supplied charge.....	R-410A	R-410A
Glossy corrosion resistant finish.....	✓	✓
High pressure switch.....	✓	✓
Internal high / low pressure & temperature protection.....	✓	✓
Liquid line filter drier - factory installed or factory supplied for field install.....	✓	✓
Spinnaker gray cabinet.....	✓	✓
<b>10-year limited warranty on compressor, outdoor coil &amp; all other functional parts (Residential Use)</b> .....	✓	✓
<b>Extended warranties available</b> .....	✓	✓

\* Registered Limited Warranty terms are available when you register within 60 days of installation. You can register online at [americanstandardair.com](http://americanstandardair.com) or by phone at 855-260-2975, otherwise American Standard Heating & Air Conditioning's Base Limited Warranty terms will apply. Base Limited Warranty information on specific products can be found on [ASDealerNet.com](http://ASDealerNet.com).

**Table SC-6-B — Optional Accessories**

Model Number	Description	Shipping Weight		
AY28X079.....	Evap. Defrost Control Kit.....	1.....	✓	✓
BAYCCHT301RES.....	Crankcase Heater Kit (Scroll).....	1.....	3½-5	1½-5
BAYCCHT302RES.....	Crankcase Heater Kit (Scroll).....	1.....	1½-3	1½-3
BAYECMT023.....	Extreme Conditions Mounting Kit (Base 2/3).....	2.....	1½-3	1½-4
BAYECMT004.....	Extreme Conditions Mounting Kit (Base 4).....	2.....	3½-5	43,49,60
BAYISLT101.....	Rubber Isolators.....	1.....	✓	✓
BAYKSKT263.....	Start Kit.....	1.....	2½-5	2-5
BAYLEGS007.....	Snow Legs - 7" High (Black).....	1.....	✓	✓
BAYLEGS004.....	Snow Legs - 4" High (Black).....	1.....	✓	✓
BAYLOAM107A.....	Low Ambient Kit.....	1.....	✓	✓
BAYSDEN001.....	Small Scroll Compressor Enclosures.....	8.....	1½-2½, 3½-4	1½-3½, 3049
BAYSDEN004.....	Large Scroll Compressor Enclosures.....	8.....	3, 5	3048, 5
BAYSEAC00.....	Seacoast Kit.....	1.....	✓	✓
TAYASCT501A①②.....	Anti-Short Cycle Timer.....	2.....	✓	✓
AAYSVPANL0022AA... ..	Service Valve Panel Cover Kit.....	2.....	1½-2	1½-2½
AAYSVPANL0032AA... ..	Service Valve Panel Cover Kit.....	2.....	2½,3½,4	3-4
AAYSVPANL3343AA... ..	Service Valve Panel Cover Kit.....	2.....	3	—
AAYSVPANL0044AA... ..	Service Valve Panel Cover Kit.....	2.....	5	5
PAI00309③.....	Heresite Spraypaint.....	1.....	✓	✓
BAYAWGR0004.....	<b>All Weather™ Top</b> - Fits unit base size of (W x D) of 37" X 34".....		042-060	43, 49, 60
BAYAWGR0003.....	<b>All Weather™ Top</b> - Fits unit base size of (W x D) of 33" X 30".....		030-037	36, 42, 48

**Comfort Controls — See Comfort Controls/Zone Sensors Section**

- ① Not for use with programmable thermostats.
- ② Activated on power off.
- ③ Used for additional seacoast corrosion protection. Refer to bulletin number UN-SVB11A-EN for application information.

# Split System Cooling Three Phase

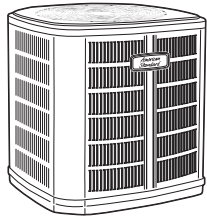

**Gold 17  
(Two Stage)**

**Table SC-7-A — Gold 17 - 3 Phase R-410A Split System Two Stage Cooling**

Model Number	Power Supply	Nom. Cap. Cooling (BTUH)	Uncrated Dimensions (in.)			Shipping Weight (lbs.)	Sound** Rating	MCA*	Max. Fuse*	Line Size (in)	
			H	W	D					OD Gas	OD Liq.
4A7C7036A3000A	208/230/3/60	36,000	45	37	34	283	72	15.0	25	3/4	3/8
4A7C7048A3000A	208/230/3/60	48,000	45	37	34	285	73	18.0	30	7/8	3/8
4A7C7060A3000A	208/230/3/60	54,000	45	37	34	308	74	22.0	35	7/8	3/8
4A7C7036A4000A	460/3/60	36,000	45	37	34	283	72	8.0	15	3/4	3/8
4A7C7048A4000A	460/3/60	48,000	45	37	34	285	73	9.0	15	7/8	3/8
4A7C7060A4000A	460/3/60	54,000	45	37	34	308	74	10.0	15	7/8	3/8

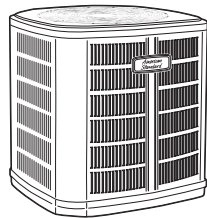

**Silver 14  
(Single Stage)**

**Table SC-7-B — Silver 14 - 3 Phase R-410A Split System Single Stage Cooling**

Model Number	Power Supply	Nom. Cap. Cooling (BTUH)	Uncrated Dimensions (in.)			Shipping Weight (lbs.)	Sound** Rating	MCA*	Max. Fuse*	Line Size (in)	
			H	W	D					OD Gas	OD Liq.
4A7C4036A3000A	208/230/3/60	36,000	33	33	30	183	73	12.0	20	3/4	3/8
4A7C4042A3000A	208/230/3/60	42,000	29	37	34	216	72	15.0	25	3/4	3/8
4A7C4048A3000A	208/230/3/60	48,000	29	37	34	221	72	18.0	30	7/8	3/8
4A7C4060A3000A	208/230/3/60	54,000	37	37	34	246	72	21.0	35	7/8	3/8
4A7C4036A4000A	460/3/60	36,000	33	33	30	183	73	8.0	15	3/4	3/8
4A7C4042A4000A	460/3/60	42,000	29	37	34	216	72	8.0	15	3/4	3/8
4A7C4048A4000A	460/3/60	48,000	29	37	34	221	72	8.0	15	7/8	3/8
4A7C4060A4000A	460/3/60	54,000	37	37	34	246	72	9.0	15	7/8	3/8

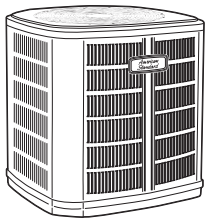

**Silver 13  
(Single Stage)**

**Table SC-7-C — Silver 13 - 3 Phase R-410A Split System Single Stage Cooling**

Model Number	Power Supply	Nom. Cap. Cooling (BTUH)	Uncrated Dimensions (in.)			Shipping Weight (lbs.)	Sound** Rating	MCA*	Max. Fuse*	Line Size (in)	
			H	W	D					OD Gas	OD Liq.
4A7C3036B3000B	208/230/3/60	36,000	29	33	30	176	78	13.6	20	3/4	3/8
4A7C3042D3000D	208/230/3/60	42,000	29	37	34	228	74	18.0	30	3/4	3/8
4A7C3048D3000D	208/230/3/60	48,000	29	37	34	235	75	18.0	30	7/8	3/8
4A7C3060D3000D	208/230/3/60	54,000	37	37	34	261	75	20.0	35	7/8	3/8
4A7C3036B4000B	460/3/60	36,000	29	33	30	176	78	7.7	15	3/4	3/8
4A7C3042D4000D	460/3/60	42,000	29	37	34	228	79	8.2	15	3/4	3/8
4A7C3048D4000D	460/3/60	48,000	29	37	34	235	79	8.4	15	7/8	3/8
4A7C3060D4000D	460/3/60	54,000	37	37	34	261	80	10.3	15	7/8	3/8

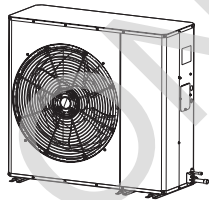

**Silver 16  
(Single Stage)**

**Table SC-7-D — Silver 16-410A Side Discharge Single Stage Cooling — Three Phase**

Model Number	Power Supply	Nom. Cap. Cooling (BTUH)	Uncrated Dimensions (in.)			Shipping Weight (lbs.)	Sound** Rating	MCA*	Max. Fuse*	Line Size (in)	
			H	W	D					OD Gas	OD Liq.
4A7S6036A3000A <sup>①</sup>	208/230/3/60	36,000	37	47	18	242	73	11.2	15	3/4	3/8
4A7S6048A3000A <sup>①</sup>	208/230/3/60	48,000	37	47	18	243	76	18.3	30	7/8	3/8
4A7S6060A3000A <sup>①</sup>	208/230/3/60	54,000	43	47	18	263	76	20.9	35	7/8	3/8
4A7S6036A4000A <sup>①</sup>	460/3/60	36,000	37	47	18	242	73	5.2	15	3/4	3/8
4A7S6048A4000A <sup>①</sup>	460/3/60	48,000	37	47	18	243	76	8.4	15	7/8	3/8
4A7S6060A4000A <sup>①</sup>	460/3/60	54,000	43	47	18	263	76	9.5	15	7/8	3/8

① For coastal applications where units are installed within one (1) mile of salt water, epoxy coated models are available for order. Model numbers with "COT" in the eleventh (11) through thirteenth (13) digits represent an epoxy coated coil. Example: 4A7S6036A3COTA These models have an 8 week lead time after order.

\* Information subject to change. Please confirm with current Product Data/Service Facts for current factory production.

\*\* Rated in accordance with AHRI Standard 270-2008 (Min/Max when applicable).

# Split System Cooling Three Phase

Split System Cooling

**Table SC-8-A — Features**

	Gold 17 (4A7C7)	Silver 14 (4A7C4)	Silver 13 (4A7C3)	Silver 16 (4A7S6)
• SEER up to .....	17.50	16.50	14.50	17.50
• <b>Duration™</b> compressor .....	✓	✓	✓	✓
• <b>Comfort-R™</b> mode approved .....	✓	✓	✓	✓
• <b>DuraBase™</b> base, fast complete drain, weatherproof .....	✓	✓	✓	—
• <b>Easy-Sess</b> cabinet, service access & refrigerant connections with full coil protection .....	✓	✓	✓	—
• <b>Spine Fin™</b> coil .....	✓	✓	✓	—
• <b>Copper Tubing</b> , Aluminum Fin coil .....	—	—	—	✓
• Compressor sump heat - factory installed .....	✓	✓	✓	✓
• Refrigerant (R-22 not factory supplied) .....	R-410A	R-410A	R-22	R-410A
• Glossy corrosion resistant finish .....	✓	✓	✓	✓
• High pressure switch .....	✓	✓	✓	✓
• Compressor sound enclosure .....	—	—	3½	—
• Internal high / low pressure & temperature protection .....	✓	✓	✓	✓
• Liquid line filter drier - factory installed or factory supplied for field install .....	✓	✓	✓	✓
• Spinnaker gray cabinet .....	✓	✓	✓	✓
• <b>5-year basic limited warranty on compressor, 1-year on outdoor coil &amp; all other functional parts (Commercial Use)</b> .....	✓	✓	✓	—
• <b>10-year limited warranty on compressor, outdoor coil &amp; all other functional parts with registration* (Residential Use)</b> .....	✓	✓	✓	✓
• <b>Extended warranties available</b> .....	✓	✓	✓	✓

\* Registered Limited Warranty terms are available when you register within 60 days of installation. You can register online at americanstandardair.com or by phone at 855-260-2975, otherwise American Standard Heating & Air Conditioning's Base Limited Warranty terms will apply. Base Limited Warranty information on specific products can be found on ASDealerNet.com.

**Table SC-8-B — Optional Accessories**

Model Number	Description	Shipping Weight	Gold 17 (4A7C7)	Silver 14 (4A7C4)	Silver 13 (4A7C3)	Silver 16 (4A7S6)
AY28X079.....	Evap. Defrost Control Kit .....	1.....	✓	✓	✓	✓
BAYCCHT301RES.....	Crankcase Heater Kit (Scroll).....	1.....	—	—	—	A
BAYCCHT302RES.....	Crankcase Heater Kit (Scroll).....	1.....	—	—	—	A
BAYECMT023.....	Extreme Conditions Mounting Kit (Base 2/3).....	2.....	—	3	2½-3	—
BAYECMT004.....	Extreme Conditions Mounting Kit (Base 4).....	2.....	3-5	3½-5	3½-5	—
BAYISLT101.....	Rubber Isolators.....	1.....	✓	✓	✓	✓
BAYKSKT263.....	Start Kit.....	1.....	✓	—	5	—
BAYKSKT260.....	Start Kit.....	1.....	—	—	3	—
BAYLEGS007.....	Snow Legs - 7" High (Black).....	1.....	✓	✓	✓	✓
BAYLEGS004.....	Snow Legs - 4" High (Black).....	1.....	✓	✓	✓	✓
BAYLOAM107A.....	Low Ambient Kit.....	1.....	✓	✓	✓	—
BAYSDEN001.....	Single Cylinder Compressor Enclosures.....	8.....	—	3½-4	3-4	—
BAYSDEN004.....	Large Scroll Compressor Enclosures.....	8.....	✓	3, 5	5	4-5
BAYSEAC001.....	Seacoast Kit.....	1.....	✓	✓	✓	—
BAYWIND101.....	Wind Baffle.....	1.....	—	—	—	3-5
TAYASCT501A①.....	Anti-Short Cycle Timer.....	2.....	✓	✓	✓	—
TAYSVPANL0032AA.....	Service Valve Panel Cover Kit.....	2.....	—	3½-4	3-4	—
TAYSVPANL3343AA.....	Service Valve Panel Cover Kit.....	2.....	—	3	2½	—
TAYSVPANL0044AA.....	Service Valve Panel Cover Kit.....	2.....	—	5	5	—
TAYSVPANL0046AA.....	Service Valve Panel Cover Kit.....	2.....	3-5	—	—	—
PAI00309②.....	Heresite Spraypaint.....	1.....	✓	✓	✓	✓
BRK05033③.....	Wall Mount Kit.....	1.....	✓	✓	✓	✓
BAYTWGR0004.....	<b>All Weather™ Top</b> - Fits unit base size of (W x D) of 37" X 34".....	1.....	✓	036-061	—	—
BAYTWGR0003.....	<b>All Weather™ Top</b> - Fits unit base size of (W x D) of 33" X 30".....	1.....	—	018-030	—	—
BAYSDHG001A.....	Hail Guard Kit 3.2.....	1.....	—	—	—	✓
BAYSDHG002A.....	Hail Guard Kit 3.3.....	1.....	—	—	—	✓
BAYSDHG003A.....	Hail Guard Kit 4.3.....	1.....	—	—	—	✓
BAYSDHG004A.....	Hail Guard Kit 4.4.....	1.....	—	—	—	✓

A = Factory Installed

**Comfort Controls — See Comfort Controls/Zone Sensors Section**

- ① Not for use with programmable thermostats.
- ② Activated on Power Off.
- ③ Used for additional seacoast corrosion protection. Refer to bulletin number UN-SVB11A-EN for application information.

For complete equipment / combination selections, installation instructions and warranty information, please refer to Product Data/Ratings and/or Installers Guides and Limited Warranty Handbooks.

# Split System Heat Pumps Summary of System Ratings

**IMPORTANT:**

This table is intended as an at-a-glance overview. See AHRI for complete and up-to-date indoor and outdoor system ratings by model. Not all matches will attain ratings shown below.

Model Not Offered		NA-System Combination "Not Allowed"																				
Silver 14		Silver 14 - 14 SEER Single Stage Heat Pump and Air Handler Ratings Summary (up to 14 SEER / 12 EER / 8.5 HSPF)																				
		1.5 Ton			2 Ton			2.5 Ton			3 Ton			3.5 Ton			4 Ton			5 Ton		
		SEER	EER	HSPF	SEER	EER	HSPF	SEER	EER	HSPF	SEER	EER	HSPF	SEER	EER	HSPF	SEER	EER	HSPF	SEER	EER	HSPF
TEM / TMM Air Handlers	TEM4	14.00	11.50	8.50	14.00	11.50	8.50	14.00	11.50	8.50	14.00	11.50	8.50	14.00	11.50	8.50	14.00	11.50	8.50	14.00	11.50	8.50
	TMM4	NA			14.00	11.50	8.20	14.00	11.50	8.50	NA			NA			NA			NA		
	TMM5	14.00	11.50	8.50	14.00	11.50	8.50	14.00	11.50	8.50	14.00	12.00	8.20	NA			NA			NA		
	TEM6/8	NA			14.50	12.00	8.50	14.50	12.00	8.50	14.50	12.00	8.50	14.50	12.00	8.50	14.50	12.00	8.50	14.50	12.00	8.50
ForeFront™ Air Handlers	GAF2	14.00	11.50	8.50	14.00	11.50	8.50	14.00	12.00	8.50	14.00	12.00	8.20	NA			NA			NA		
	TAM4	14.00	11.50	8.50	14.00	11.50	8.50	14.00	11.50	8.50	14.00	11.50	8.20	NA			14.00	11.50	8.50	14.00	11.50	8.50
	GAM5	14.50	12.00	8.50	14.50	12.00	8.50	14.50	12.00	8.50	14.50	12.00	8.50	14.50	12.00	8.50	14.50	12.00	8.50	14.00	11.70	8.50
	TAM9	14.50	12.00	8.50	14.50	12.00	8.50	14.50	12.00	8.50	14.50	12.00	8.50	14.50	12.00	8.50	14.50	12.00	8.50	14.50	12.00	8.50

Silver 15		Silver 15 - 15 SEER Single Stage Heat Pump and Air Handler Ratings Summary (up to 15 SEER / 12.5 EER / 9.5 HSPF)																				
		1.5 Ton			2 Ton			2.5 Ton			3 Ton			3.5 Ton			4 Ton			5 Ton		
		SEER	EER	HSPF	SEER	EER	HSPF	SEER	EER	HSPF	SEER	EER	HSPF	SEER	EER	HSPF	SEER	EER	HSPF	SEER	EER	HSPF
TEM / TMM Air Handlers	TEM4	15.00	12.50	8.50	15.00	12.50	8.50	14.25	12.00	8.50	14.50	12.00	8.50	NA			NA			NA		
	TMM4	NA			14.00	11.50	8.20	14.00	11.50	8.50	NA			NA			NA			NA		
	TMM5	15.00	12.50	8.50	15.00	12.50	8.50	15.00	12.50	8.50	15.00	12.50	9.50	NA			NA			NA		
	TEM6/8	15.00	12.50	8.85	15.00	12.50	9.00	15.00	12.50	9.50	15.00	12.50	9.50	15.00	12.50	9.50	15.00	12.50	9.50	15.00	12.50	9.50
ForeFront™ Air Handlers	GAF2	15.00	12.50	8.50	15.00	12.50	8.50	15.00	12.50	9.50	NA			NA			NA			NA		
	TAM4	15.00	12.50	8.50	15.00	12.50	9.00	14.50	12.00	9.00	14.25	12.00	9.00	14.50	12.00	8.50	15.00	12.00	8.50	14.50	12.00	8.50
	GAM5	15.00	12.50	8.50	15.00	12.50	9.00	15.00	12.50	9.50	15.00	12.50	9.50	15.00	12.50	9.50	15.00	12.50	9.00	15.00	12.50	8.50
	TAM9	15.00	12.50	9.00	15.25	12.50	9.00	15.25	12.50	9.50	15.00	12.50	9.50	15.00	12.50	9.50	15.00	12.50	9.00	15.00	12.50	9.00

Silver 16		Silver 16 - 16 SEER Single Stage Heat Pump and Air Handler Ratings Summary (up to 17 SEER / 13 EER / 9.6 HSPF)																				
		1.5 Ton			2 Ton			2.5 Ton			3 Ton			3.5 Ton			4 Ton			5 Ton		
		SEER	EER	HSPF	SEER	EER	HSPF	SEER	EER	HSPF	SEER	EER	HSPF	SEER	EER	HSPF	SEER	EER	HSPF	SEER	EER	HSPF
TEM / TMM Air Handlers	TEM4	15.00	12.50	8.50	15.00	12.00	8.20	NA			15.00	12.00	8.20	NA			NA			NA		
	TMM5	16.00	13.00	9.00	16.00	13.00	8.50	NA			NA			NA			NA			NA		
	TEM6/8	16.00	12.50	9.00	16.00	13.00	9.60	16.00	13.00	9.60	16.00	13.00	9.60	16.00	13.00	9.60	16.00	13.00	9.60	16.00	13.00	9.60
ForeFront™ Air Handlers	GAF2	16.00	13.00	8.55	14.00	12.00	8.20	NA			NA			NA			NA			NA		
	TAM4	15.00	12.50	8.55	15.00	12.50	8.20	NA			14.75	12.50	8.50	15.00	12.00	8.50	15.00	12.00	8.50	15.00	12.00	8.50
	GAM5	16.00	13.00	8.55	16.00	12.50	9.00	16.00	12.50	9.00	16.00	12.50	9.00	16.00	12.50	9.00	16.00	12.50	9.00	14.50	12.00	8.20
	TAM9	17.00	13.00	9.00	17.00	13.50	9.50	17.00	13.50	9.60	16.00	13.00	9.60	16.00	13.00	9.60	16.00	13.00	9.50	15.00	12.50	9.00

Silver 16 Low Profile Side Discharge		Silver 16 - 16 SEER Low Profile Single Stage Heat Pump and Air Handler Ratings Summary (up to 16.5 SEER / 13.5 EER / 10.0 HSPF)																				
		1.5 Ton			2 Ton			2.5 Ton			3 Ton			3.5 Ton			4 Ton			5 Ton		
		SEER	EER	HSPF	SEER	EER	HSPF	SEER	EER	HSPF	SEER	EER	HSPF	SEER	EER	HSPF	SEER	EER	HSPF	SEER	EER	HSPF
TEM / TMM Air Handlers	TEM4	14.50	12.00	8.50	14.50	12.00	9.00	14.00	12.00	8.50	14.50	12.00	9.00	14.50	12.00	9.00	14.00	12.00	9.00	14.00	11.50	9.00
	TMM5	16.00	13.00	9.00	16.00	13.00	8.50	NA			NA			NA			NA			NA		
	TEM6/8	16.00	13.00	9.50	16.00	13.00	9.50	15.50	12.50	10.00	16.50	13.50	10.00	16.00	13.00	10.00	15.00	12.50	10.00	14.50	11.50	10.00
ForeFront™ Air Handlers	GAF2	16.00	13.50	9.00	15.00	12.50	9.00	14.50	12.00	8.50	14.00	12.00	9.00	NA			NA			NA		
	TAM4	14.50	12.00	8.50	14.50	12.00	9.00	14.00	11.50	8.50	14.50	12.00	9.50	14.00	11.00	9.00	14.50	12.00	9.50	14.50	11.50	9.00
	GAM5	15.00	12.50	9.00	15.00	12.50	9.00	15.00	12.50	9.00	15.00	12.50	9.00	15.00	12.50	9.00	15.00	12.00	9.00	14.00	11.50	9.00
	TAM9	16.00	13.00	9.50	16.00	13.50	9.50	16.00	13.00	9.00	16.00	13.00	10.00	15.00	12.50	9.50	15.00	12.00	9.50	14.00	11.50	9.00

For complete equipment / combination selections, installation instructions and warranty information, please refer to Product Data/Ratings and/or Installers Guides and Limited Warranty Handbooks.

# Split System Heat Pumps Summary of System Ratings

**IMPORTANT:**

This table is intended as an at-a-glance overview. See AHRI for complete and up-to-date indoor and outdoor system ratings by model. Not all matches will attain ratings shown below.

Model Not Offered		Gold 17 - Two Stage 17 SEER Heat Pump and Air Handler Ratings Summary (up to 17 SEER / 13.5 EER / 9.5 HSPF)																							
Gold 17-2 Stage		1.5 Ton			2 Ton			2.5 Ton			3 Ton			3.5 Ton			4 Ton			5 Ton					
		SEER	EER	HSPF	SEER	EER	HSPF	SEER	EER	HSPF	SEER	EER	HSPF	SEER	EER	HSPF	SEER	EER	HSPF	SEER	EER	HSPF			
TEM Air Handlers	TEM6/8				17.00	12.50	8.50				17.00	12.50	9.60				17.00	12.50	9.60	15.00	12.00	9.60			
ForeFront™ Air Handlers	GAM5				16.00	12.50	9.00				16.00	12.50	9.00				16.00	12.00	9.00	15.00	11.00	9.00			
	TAM9				17.25	13.50	9.50				17.75	13.00	9.00				17.25	12.50	9.00	16.25	12.00	9.00			

Platinum 18 AccuComfort™		Platinum 18 - SEER AccuComfort™ Variable Speed Heat Pump and Air Handler Ratings Summary (up to 18 SEER / 13.5 EER / 10.0 HSPF)																							
Platinum 18 AccuComfort™		1.5 Ton			2 Ton			2.5 Ton			3 Ton			3.5 Ton			4 Ton			5 Ton					
		SEER	EER	HSPF	SEER	EER	HSPF	SEER	EER	HSPF	SEER	EER	HSPF	SEER	EER	HSPF	SEER	EER	HSPF	SEER	EER	HSPF			
ForeFront™ Air Handlers	TAM9				18.00	13.00	10.00				18.00	13.00	10.00				18.00	12.50	10.00	18.00	12.50	10.00			

Platinum 19 AccuComfort™		Platinum 19 - SEER AccuComfort™ Variable Speed Heat Pump and Air Handler Ratings Summary (up to 19.5 SEER / 13.0 EER / 11.5 HSPF)																							
Platinum 19 AccuComfort™		1.5 Ton			2 Ton			2.5 Ton			3 Ton			3.5 Ton			4 Ton			5 Ton					
		SEER	EER	HSPF	SEER	EER	HSPF	SEER	EER	HSPF	SEER	EER	HSPF	SEER	EER	HSPF	SEER	EER	HSPF	SEER	EER	HSPF			
TEM Air Handlers	TEM8				19.50	13.00	11.00				18.00	12.50	10.50				19.00	12.50	11.00	18.00	10.50	10.75			
ForeFront™ Air Handlers	TAM9				19.50	13.00	11.50				17.75	12.50	11.00				19.00	11.50	11.50	19.00	10.50	11.00			

Platinum 20 AccuComfort™		Platinum 20 - SEER AccuComfort™ Variable Speed Heat Pump and Air Handler Ratings Summary (up to 21.0 SEER / 13.50 EER / 10.0 HSPF)																							
Platinum 20 AccuComfort™		1.5 Ton			2 Ton			2.5 Ton			3 Ton			3.5 Ton			4 Ton			5 Ton					
		SEER	EER	HSPF	SEER	EER	HSPF	SEER	EER	HSPF	SEER	EER	HSPF	SEER	EER	HSPF	SEER	EER	HSPF	SEER	EER	HSPF			
ForeFront™ Air Handlers	TAM9				19.25	13.75	10.00				21.00	13.50	10.00				19.25	12.50	10.00	19.00	12.70	10.00			

# AccuComfort™ Variable Speed Heat Pumps Single Phase – 2-5 Tons



**Platinum 20**  
(Variable Speed)

**Table SH-3-A - Platinum 20 R-410A Split System Variable Speed Heat Pump (25–100% capacity)—with AccuLink™ ②**

Model Number	Power Supply	Nom. Cap. Cooling (BTUH)	Uncrated Dimensions (in.)			Shipping Weight (lbs.)	Sound** Rating		MCA*	Max. Fuse*	Line Size (in)	
			H	W	D		(Cool)	(Heat)			OD Gas	OD Liq.
4A6V0X24A1000A	208/230/1/60	24,000	41	33	30	225	54/65	60/69	17.0	25	3/4	3/8
4A6V0X36A1000A	208/230/1/60	36,000	41	37	34	263	59/70	60/72	26.0	40	3/4	3/8
4A6V0X48A1000A	208/230/1/60	48,000	41	37	34	275	61/74	62/76	29.0	45	7/8	3/8
4A6V0X60A1000A	208/230/1/60	54,000	45	37	34	285	57/73	61/74	37.0	50	7/8	3/8



**Platinum 19**  
(Variable Speed)

**Table Table SH-3-B - Platinum 19 R-410A Side Discharge Variable Speed Heat Pump (50-100% capacity)—with AccuLink™ ②**

Model Number	Power Supply	Nom. Cap. Cooling (BTUH)	Uncrated Dimensions (in.)			Shipping Weight (lbs.)	Sound** Rating		MCA*	Max. Fuse*	Line Size (in)	
			H	W	D		(Cool)	(Heat)			OD Gas	OD Liq.
4A6L9024A1000B①	208/230/1/60	24,000	37	47	18	230	50	49	19.1	25	5/8	3/8
4A6L9036A1000B①	208/230/1/60	36,000	37	47	18	252	48	49	26.9	30	3/4	3/8
4A6L9048A1000B①	208/230/1/60	48,000	43	47	18	271	54	52	31.8	35	7/8	3/8
4A6L9060A1000B①	208/230/1/60	54,000	43	47	18	271	56	52	36.1	40	7/8	3/8



**Platinum 18**  
(Variable Speed)

**Table SH-3-C - Platinum 18 R-410A Split System Variable Speed Heat Pump (25–100% capacity)—with AccuLink™ ②**

Model Number	Power Supply	Nom. Cap. Cooling (BTUH)	Uncrated Dimensions (in.)			Shipping Weight (lbs.)	Sound** Rating		MCA*	Max. Fuse*	Line Size (in)	
			H	W	D		(Cool)	(Heat)			OD Gas	OD Liq.
4A6V8X24A1000A	208/230/1/60	24,000	41	33	30	225	54/65	60/69	17.0	25	5/8	3/8
4A6V8X36A1000A	208/230/1/60	36,000	41	33	30	238	56/70	60/74	25.0	35	3/4	3/8
4A6V8X48A1000A	208/230/1/60	48,000	41	37	34	268	61/74	62/76	28.0	40	7/8	3/8
4A6V8X60A1000A	208/230/1/60	54,000	45	37	34	285	57/73	61/74	37.0	50	7/8	3/8

① For coastal applications where units are installed within one (1) mile of salt water, epoxy coated models are available for order. Model numbers with "COT" in the eleventh (11) through thirteenth (13) digits represent an epoxy coated coil. Example: 4TWL9036A1COTA. These models have an 8 week lead time after order.

② Must use TCONT850, TZONE950 or TZONE1050 control.

\* Information subject to change. Please confirm with current Product Data/Service Facts for current factory production.

\*\* Rated in accordance with ARI Standard 275



**ALL WEATHER™ TOP ACCESSORY**

BAYAWGR0003 - Fits base sizes 33"x30" (WxD)

BAYAWGR0004 - Fits base sizes 37"x34" (WxD)

Split System Heat Pumps



# AccuComfort™ Variable Speed Heat Pump Single Phase - 2-5 Tons

**Table SH-4-A — Features**

	Platinum 20 (4A6V0)	Platinum 19 (4A6L9)	Platinum 18 (4A6V8)
• SEER up to .....	21.00	19.50	18.00
• HSPF up to.....	10.00	12.00	10.00
• <b>Duration™</b> compressor .....	1	1	1
• Number of stages .....	Variable	Variable	Variable
• <b>Comfort-R™</b> mode approved .....	✓	✓	✓
• <b>AccuLink™</b> system.....	✓	✓	✓
• <b>DuraBase™</b> base, fast complete drain, weatherproof .....	✓	—	✓
• <b>Easy-Sess™</b> cabinet, service access & refrigerant connections with full coil protection.....	✓	—	✓
• <b>Spine Fin™</b> coil.....	✓	—	✓
• Compressor sound enclosure .....	✓	—	—
• Compressor sump heat .....	✓	✓	✓
• Factory supplied charge .....	✓	✓	✓
• Glossy corrosion resistant finish.....	R-410A	R-410A	R-410A
• High pressure switch .....	✓	✓	✓
• Low pressure protection .....	✓	✓	✓
• Internal high / low pressure & temperature protection .....	✓	✓	✓
• Liquid line filter drier - factory installed or factory supplied for field install.....	✓	✓	✓
• Seacoast shield - factory installed.....	✓	—	—
• Spinnaker gray cabinet.....	✓	✓	✓
• 10-year limited warranty on compressor, outdoor coil & all other functional parts .....	—	✓	—
• <b>12-year limited warranty on compressor, 10-year on outdoor coil &amp; all other functional parts with registration* (Residential Use)</b> .....	✓	—	✓
• <b>Extended warranties available</b> .....	✓	✓	✓

\* Registered Limited Warranty terms are available when you register within 60 days of installation. You can register online at americanstandardair.com or by phone at 855-260-2975, otherwise American Standard Heating & Air Conditioning's Base Limited Warranty terms will apply. Base Limited Warranty information on specific products can be found on ASDealerNet.com.

Split System Heat Pumps

**Table SH-4-B — Optional Accessories**

Model Number	Description	Shipping Weight			
BAYECMT023	Extreme Conditions Mounting Kit (Base 2/3)	2	2	—	024-036
BAYECMT004	Extreme Conditions Mounting Kit (Base 4)	2	3-5	—	037-060
BAYISLT101	Rubber Isolators	1	✓	✓	✓
BAYLEGS007	Snow Legs - 7" High (Black)	1	✓	✓	✓
BAYLEGS004	Snow Legs - 4" High (Black)	1	✓	✓	✓
BAYVDTA003	Vertical Discharge Air Kit Base 3	10	2	—	—
BAYVDTA004	Vertical Discharge Air Kit Base 4	10	3-5	—	—
BAYSEAC001	Seacoast Kit	1	—	—	✓
BAYWIND101	Wind Baffle Kit	5	—	✓	—
BAYSDHG003A	Hail Guard Kit 4.3	5	—	2-3	—
BAYSDHG004A	Hail Guard Kit 4.4	5	—	4-5	—
PAI003091	Heresite Spraypaint	1	✓	✓	✓
BRK050332	Wall Mount Kit	—	—	✓	—
BAYSEN01ATEMPA	External Ambient Kit	—	✓	✓	✓
BAYTWGR0004	<b>All Weather™ Top</b> - Fits unit base size of (W x D) of 37" X 34"	—	—	—	048-060
BAYTWGR0003	<b>All Weather™ Top</b> - Fits unit base size of (W x D) of 33" X 30"	—	—	—	024-036
BAYECC001	Extreme Coastal Conditions Kit*	—	✓	—	✓

\* Not for use in Arizona or other extreme heat applications.†

**Comfort Controls — See Comfort Controls/Zone Sensors Section**

- ① Used for additional seacoast corrosion protection. Refer to bulletin number UN-SVB11A-EN for application information.
- ② Available from Trane Parts.

# Split System Heat Pumps Single Phase – 1½-5 Tons

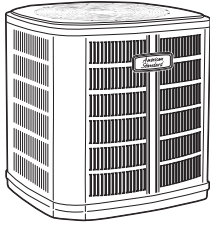

**Gold 17  
(Two Stage)**

**Table SH-5-A — Gold 17 R-410A Split System Two Stage Heat Pump (70/100% capacity)**

Model Number	Power Supply	Nom. Cap. Cooling (BTUH)	Uncrated Dimensions (in.)			Shipping Weight (lbs.)	Sound** Rating	MCA*	Max. Fuse*	Line Size (in)	
			H	W	D					OD Gas	OD Liq.
4A6H7024A1000D	208/230/1/60	24,000	41	37	34	272	72	15.0	25	3/4	3/8
4A6H7036B1000D	208/230/1/60	36,000	41	37	34	258	72	20.0	35	3/4	3/8
4A6H7048A1000D	208/230/1/60	48,000	45	37	34	329	72	28.0	45	7/8	3/8
4A6H7060A1000D	208/230/1/60	54,000	45	37	34	330	74	35.0	60	7/8	3/8

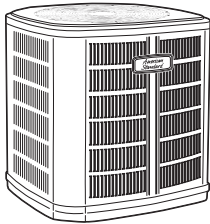

**Silver 16  
(Single Stage)**

**Table SH-5-B — Silver 16 R-410A Split System Single Stage Heat Pump**

Model Number	Power Supply	Nom. Cap. Cooling (BTUH)	Uncrated Dimensions (in.)			Shipping Weight (lbs.)	Sound** Rating	MCA*	Max. Fuse*	Line Size (in)	
			H	W	D					OD Gas	OD Liq.
4A6H6018H1000A	208/230/1/60	18,000	33	33	30	196	74	12.0	20	3/4	3/8
4A6H6024H1000A	208/230/1/60	24,000	33	33	30	208	71	14.0	25	3/4	3/8
4A6H6030H1000A	208/230/1/60	30,000	37	37	34	245	70	17.0	25	3/4	3/8
4A6H6036H1000A	208/230/1/60	36,000	37	37	34	246	70	18.0	30	3/4	3/8
4A6H6042H1000A	208/230/1/60	42,000	45	37	34	277	72	24.0	40	7/8	3/8
4A6H6048H1000A	208/230/1/60	48,000	45	37	34	300	72	26.0	40	7/8	3/8
4A6H6060H1000A	208/230/1/60	54,000	45	37	34	301	72	32.0	50	7/8	3/8

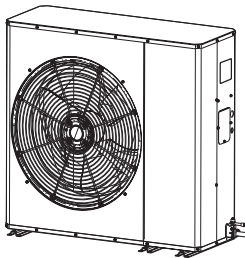

**Silver 16  
(Single Stage)**

**Table SH-5-C — Silver 16 R-410A Side Discharge Single Stage Heat Pump**

Model Number	Power Supply	Nom. Cap. Cooling (BTUH)	Uncrated Dimensions (in.)			Shipping Weight (lbs.)	Sound** Rating	MCA*	Max. Fuse*	Line Size (in)	
			H	W	D					OD Gas	OD Liq.
4A6L6018A1000A	208/230/1/60	18,000	31	40	15	186	69	12.0	20	3/4	3/8
4A6L6024A1000A	208/230/1/60	24,000	31	40	15	186	69	13.0	20	3/4	3/8
4A6L6030A1000A	208/230/1/60	30,000	37	47	18	222	70	13.0	20	3/4	3/8
4A6L6036A1000A	208/230/1/60	36,000	37	47	18	225	71	19.0	30	7/8	3/8
4A6L6042A1000A	208/230/1/60	42,000	37	47	18	244	71	25.0	40	7/8	3/8
4A6L6048A1000A	208/230/1/60	48,000	43	47	18	266	74	26.0	45	7/8	3/8
4A6L6060A1000A	208/230/1/60	54,000	43	47	18	267	74	29.0	50	7/8	3/8

① For coastal applications where units are installed within one (1) mile of salt water, epoxy coated models are available for order. Model numbers with "COT" in the eleventh (11) through thirteenth (13) digits represent an epoxy coated coil. Example: 4A6L6036A1COTA. These models have an 8 week lead time after order.

\* Information subject to change. Please confirm with current Product Data/Service Facts for current factory production.

\*\* Rated in accordance with AHRI Standard 270-2008 (Min/Max when applicable).

# Split System Heat Pumps Single Phase – 1½-5 Tons

**Table SH-6-A — Features**

	Gold 17 (4A6H7)	Silver 16 (4A6H6)	Silver 16 (4A6L6)
• SEER up to .....	17.50	17.00	17.00
• HSPF up to.....	9.60	9.60	10.00
• <b>Duration™</b> compressor.....	✓	✓	✓
• Number of stages .....	2	1	1
• <b>Comfort-R™</b> mode approved.....	✓	✓	✓
• <b>DuraBase™</b> base, fast complete drain, weatherproof.....	✓	✓	—
• <b>Easy-Sess™</b> cabinet, service access & refrigerant connections with full coil protection.....	✓	✓	—
• <b>Spine Fin™</b> coil.....	✓	✓	—
• <b>Copper Tube Aluminum Fin</b> coil .....	—	—	✓
• Electronic Expansion Valve (EEV) .....	✓	—	—
• Compressor sump heat - factory installed.....	—	—	—
• Factory supplied charge .....	R-410A	R-410A	R-410A
• Glossy corrosion resistant finish.....	✓	✓	✓
• High pressure switch .....	✓	✓	✓
• Low pressure switch .....	✓	✓	✓
• Liquid line filter drier - factory supplied for field install .....	✓	✓	✓
• Seacoast shield - factory installed.....	✓	—	—
• Spinnaker gray cabinet.....	✓	✓	✓
• <b>12-year limited warranty on compressor, 10-year on outdoor coil &amp; all other functional parts with registration*</b> .....	✓	—	—
• <b>10-year limited warranty on compressor, outdoor coil &amp; all other functional parts with registration</b> .....	—	✓	✓
• <b>Extended warranties available</b> .....	✓	✓	✓

\* Registered Limited Warranty terms are available when you register within 60 days of installation. You can register online at americanstandardair.com or by phone at 855-260-2975, otherwise American Standard Heating & Air Conditioning's Base Limited Warranty terms will apply. Base Limited Warranty information on specific products can be found on ASDealerNet.com.

**Table SH-6-B — Optional Accessories**

Model Number	Description	Shipping Weight			
AY28X084.....	Evaporator Defrost Control.....	1.....	✓	✓	✓
BAYCCHT301RES.....	Crankcase Heater Kit (Scroll).....	1.....	—	3½-5	3½-5
BAYCCHT302RES.....	Crankcase Heater Kit (Scroll).....	1.....	—	1½-3	1½-3
BAYECMT023.....	Extreme Conditions Mounting Kit (Base 2/3).....	2.....	—	1½-2	—
BAYECMT004.....	Extreme Conditions Mounting Kit (Base 4).....	2.....	✓	2½-5	—
BAYISLT101.....	Rubber Isolators.....	1.....	✓	✓	✓
BAYKSKT263.....	Start kit (Scroll).....	1.....	2-3	✓	✓
BAYKSKT266.....	Start kit (Scroll).....	1.....	4-5	—	—
BAYLEGS007.....	Snow Legs - 7" High (Black).....	1.....	✓	✓	✓
BAYLEGS004.....	Snow Legs - 4" High (Black).....	1.....	✓	✓	✓
BAYLOAM107A.....	Low Ambient Kit.....	1.....	✓	✓	✓
TAYASCT501A①②.....	Anti-Short Cycle Timer.....	2.....	✓	✓	—
BAYSDEN004.....	Large Scroll Compressor Enclosures.....	8.....	✓	✓	✓
BAYSEAC001.....	Seacoast Kit.....	1.....	✓	✓	—
BAYSDHG001A.....	Hail Guard Kit 3.2.....	5.....	—	—	1½-2
BAYSDHG003A.....	Hail Guard Kit 4.3.....	5.....	—	—	2½-3½
BAYSDHG004A.....	Hail Guard Kit 4.4.....	5.....	—	—	4-5
BAYWIND102.....	Wind Baffle.....	—	—	—	1½-2
BAYWIND103.....	Wind Baffle.....	—	—	—	2½-5
AAYSVPANL3343AA.....	Service Valve Panel Cover Kit.....	2.....	2-3	1½-2	—
AAYSVPANL0044AA.....	Service Valve Panel Cover Kit.....	2.....	4-5	2½-3	—
AAYSVPANL0046AA.....	Service Valve Panel Cover Kit.....	2.....	—	3½-5	—
PAI00309③.....	Heresite Spraypaint.....	1.....	✓	✓	✓
BRK05033④.....	Wall Mount Kit.....	—	—	—	✓
BAYAWGR0004.....	<b>All Weather™ Top</b> - Fits unit base size of (W x D) of 37" X 34".....	—	✓	030-060	—
BAYAWGR0003.....	<b>All Weather™ Top</b> - Fits unit base size of (W x D) of 33" X 30".....	—	—	018-024	—

**Comfort Controls — See Comfort Controls/Zone Sensors Section**

- ① Do not use with programmable thermostats.
- ② Activated on Power Off.
- ③ Used for additional seacoast corrosion protection. Refer to bulletin number UN-SVB11A-EN for application information.
- ④ Available from Trane Parts.

BUILT TO A HIGHER STANDARD<sup>®</sup>

**American Standard<sup>®</sup>**  
HEATING & AIR CONDITIONING

# Split System Heat Pumps Single Phase – 1½-5 Tons

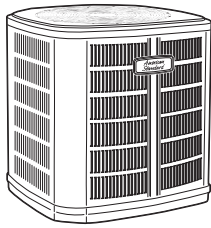

**Silver 15  
(Single Stage)**

**Table SH-7-A — Silver 15 R-410A Split System Single Stage Heat Pump**

Model Number	Power Supply	Nom. Cap. Cooling (BTUH)	Uncrated Dimensions (in.)			Shipping Weight (lbs.)	Sound** Rating	MCA*	Max. Fuse*	Line Size (in)	
			H	W	D					OD Gas	OD Liq.
4A6H5018H1000A	208/230/1/60	18,000	29	29	26	161	73	12.0	20	3/4	3/8
4A6H5019H1000A	208/230/1/60	18,000	33	33	30	196	74	12.0	20	3/4	3/8
4A6H5024H1000A	208/230/1/60	24,000	33	33	30	208	71	14.0	25	3/4	3/8
4A6H5030H1000A	208/230/1/60	30,000	29	37	34	248	72	17.0	25	3/4	3/8
4A6H5036H1000A	208/230/1/60	36,000	37	37	34	246	70	18.0	30	3/4	3/8
4A6H5042H1000A	208/230/1/60	42,000	45	37	34	277	72	22.0	35	7/8	3/8
4A6H5048H1000A	208/230/1/60	48,000	45	37	34	300	72	24.0	40	7/8	3/8
4A6H5060H1000A	208/230/1/60	54,000	45	37	34	328	72	32.0	50	7/8	3/8

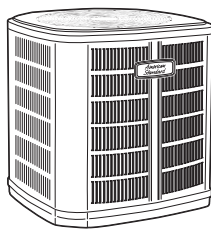

**Silver 14  
(Single Stage)**

**Table SH-7-B — Silver 14 R-410A Split System Single Stage Heat Pump**

Model Number	Power Supply	Nom. Cap. Cooling (BTUH)	Uncrated Dimensions (in.)			Shipping Weight (lbs.)	Sound** Rating	MCA*	Max. Fuse*	Line Size (in)	
			H	W	D					OD Gas	OD Liq.
4A6H4018G1000A	208/230/1/60	18,000	29	29	26	161	73	12.0	20	3/4	3/8
4A6H4024G1000A	208/230/1/60	24,000	29	33	30	191	71	14.0	25	3/4	3/8
4A6H4030G1000A	208/230/1/60	30,000	29	37	34	248	72	17.0	25	3/4	3/8
4A6H4036G1000A	208/230/1/60	36,000	29	37	34	248	75	19.0	30	7/8	3/8
4A6H4042G1000A	208/230/1/60	42,000	29	37	34	248	72	25.0	40	7/8	3/8
4A6H4048G1000A	208/230/1/60	48,000	33	37	34	256	72	25.0	45	7/8	3/8
4A6H4060G1000A	208/230/1/60	54,000	45	37	34	315	72	32.0	50	7/8	3/8

\* Information subject to change. Please confirm with current Product Data/Service Facts for current factory production.

\*\* Rated in accordance with AHRI Standard 270-2008.

# Split System Heat Pumps Single Phase – 1½-5 Tons

**Table SH-8-A — Features**

	Silver 15 (4A6H5)	Silver 14 (4A6H4)
• SEER up to .....	15.75	14.50
• HSPF up to.....	9.50	8.50
• <b>Duration™</b> compressor .....	✓	✓
• <b>Comfort-R™</b> mode approved .....	✓	✓
• <b>DuraBase™</b> base, fast complete drain, weatherproof.....	✓	✓
• <b>Easy-Sess™</b> cabinet, service access & refrigerant connections with full coil protection.....	✓	✓
• <b>Spine Fin™</b> coil.....	✓	✓
• Factory supplied charge .....	R-410A	R-410A
• Glossy corrosion resistant finish.....	✓	✓
• High pressure switch .....	✓	✓
• Low pressure switch .....	✓	✓
• Internal high / low pressure & temperature protection .....	✓	✓
• Liquid line filter drier - factory supplied for field install .....	✓	✓
• Spinnaker gray cabinet.....	✓	✓
• <b>10-year limited warranty on compressor, outdoor coil &amp; all other functional parts with registration.....</b>	✓	✓
• <b>Extended warranties available .....</b>	✓	✓

\* Registered Limited Warranty terms are available when you register within 60 days of installation. You can register online at americanstandardair.com or by phone at 855-260-2975, otherwise American Standard Heating & Air Conditioning's Base Limited Warranty terms will apply. Base Limited Warranty information on specific products can be found on ASDealerNet.com.

**Table SH-8-B — Optional Accessories**

Model Number	Description	Shipping Weight		
AY28X084.....	Evaporator Defrost Control.....	1.....	✓	✓
BAYCCHT301RES.....	Crankcase Heater Kit (Scroll).....	1.....	5	3½-5
BAYCCHT302RES.....	Crankcase Heater Kit (Scroll).....	1.....	1½-4	1½-3
BAYECMT023.....	Extreme Conditions Mounting Kit (Base 2/3).....	2.....	1½-2	1½-2
BAYECMT004.....	Extreme Conditions Mounting Kit (Base 4).....	2.....	2½-5	2½-5
BAYISLT101.....	Rubber Isolators.....	1.....	✓	✓
BAYKSKT263.....	Start kit (Scroll).....	1.....	✓	✓
BAYLEGS007.....	Snow Legs - 7" High (Black).....	1.....	✓	✓
BAYLEGS004.....	Snow legs - 4" High (Black).....	1.....	✓	✓
BAYLOAM107A.....	Low Ambient Kit.....	1.....	✓	✓
TAYASCT501A①②.....	Anti-Short Cycle Timer.....	2.....	✓	✓
BAYSDEN001.....	Small Scroll Compressor Enclosures.....	8.....	5018, 2½	1½-3½
BAYSDEN004.....	Large Scroll Compressor Enclosures.....	8.....	5019-2, 3-5	4-5
BAYSEAC001.....	Seacoast Kit.....	1.....	✓	✓
AAYSVPANL0022AA.....	Service Valve Panel Cover Kit.....	2.....	1½	1½
AAYSVPANL0032AA.....	Service Valve Panel Cover Kit.....	2.....	2½	2-3½
AAYSVPANL3343AA.....	Service Valve Panel Cover Kit.....	2.....	019,024	4
AAYSVPANL0044AA.....	Service Valve Panel Cover Kit.....	2.....	3	—
AAYSVPANL0046AA.....	Service Valve Panel Cover Kit.....	2.....	3½-5	5
PAI00309③.....	Heresite Spraypaint.....	1.....	✓	✓
BAYAWGR0004.....	<b>All Weather™ Top</b> - Fits unit base size of (W x D) of 37" X 34".....		030-060	030-060
BAYAWGR0003.....	<b>All Weather™ Top</b> - Fits unit base size of (W x D) of 33" X 30".....		019-024	024

**Comfort Controls — See Comfort Controls/Zone Sensors Section**

- ① Do not use with programmable thermostats.
- ② Activated on Power Off.

Split System Heat Pumps

# Split System Heat Pumps Three Phase

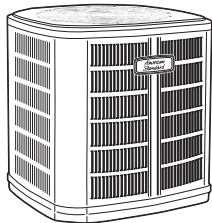

**Gold 17  
(Two Stage)  
3-Phase**

**Table SH-9-A — Gold 17 3-Phase R-410A Split System Two Stage Heat Pump - Three Phase**

Model Number	Power Supply	Nom. Cap. Cooling (BTUH)	Uncrated Dimensions (in.)			Shipping Weight (lbs.)	Sound** Rating	MCA*	Max. Fuse*	Line Size (in)	
			H	W	D					OD Gas	OD Liq.
4A6C7036A3000A	208/230/3/60	36,000	45	37	34	307	72	15.0	25	3/4	3/8
4A6C7048A3000A	208/230/3/60	48,000	45	37	34	323	73	18.0	30	7/8	3/8
4A6C7060A3000A	208/230/3/60	54,000	45	37	34	326	74	22.0	35	7/8	3/8
4A6C7036A4000A	460/3/60	36,000	45	37	34	307	72	8.0	15	3/4	3/8
4A6C7048A4000A	460/3/60	48,000	45	37	34	323	73	9.0	15	7/8	3/8
4A6C7060A4000A	460/3/60	54,000	45	37	34	326	74	10.0	15	7/8	3/8

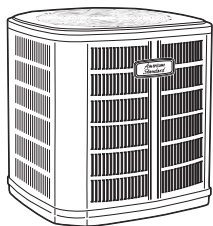

**Silver 14  
(Single Stage)  
3-Phase**

**Table SH-9-B — Silver 14 3-Phase R-410A Split System Single Stage Heat Pump - Three Phase**

Model Number	Power Supply	Nom. Cap. Cooling (BTUH)	Uncrated Dimensions (in.)			Shipping Weight (lbs.)	Sound** Rating	MCA*	Max. Fuse*	Line Size (in)	
			H	W	D					OD Gas	OD Liq.
4A6C4036A3000A	208/230/3/60	36,000	29	37	34	248	75	13.0	20	7/8	3/8
4A6C4042A3000A	208/230/3/60	42,000	29	37	34	248	74	18.0	30	7/8	3/8
4A6C4048A3000A	208/230/3/60	48,000	33	37	34	252	74	18.0	30	7/8	3/8
4A6C4060A3000A	208/230/3/60	54,000	45	37	34	325	74	21.0	35	7/8	3/8
4A6C4036A4000A	460/3/60	36,000	29	37	34	248	75	6.0	15	7/8	3/8
4A6C4042A4000A	460/3/60	42,000	29	37	34	248	74	8.0	15	7/8	3/8
4A6C4048A4000A	460/3/60	48,000	33	37	34	252	74	8.0	15	7/8	3/8
4A6C4060A4000A	460/3/60	54,000	45	37	34	324	74	9.0	15	7/8	3/8

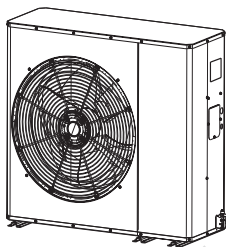

**Silver 16  
(Single Stage)**

**Table SH-9-C — Silver 16 R-410A Side Discharge Single Stage Heat Pump — Three Phase**

Model Number	Power Supply	Nom. Cap. Cooling (BTUH)	Uncrated Dimensions (in.)			Shipping Weight (lbs.)	Sound** Rating	MCA*	Max. Fuse*	Line Size (in)	
			H	W	D					OD Gas	OD Liq.
4A6S6036A3000AⓄ	208/230/3/60	36,000	37	47	18	225	72	11.3	15	7/8	3/8
4A6S6048A3000AⓄ	208/230/3/60	48,000	43	47	18	266	75	18.2	30	7/8	3/8
4A6S6060A3000AⓄ	208/230/3/60	54,000	43	47	18	267	75	15.8	25	7/8	3/8
4A6S6036A4000AⓄ	460/3/60	36,000	37	47	18	225	72	5.2	15	7/8	3/8
4A6S6048A4000AⓄ	460/3/60	48,000	43	47	18	266	75	8.4	15	7/8	3/8
4A6S6060A4000AⓄ	460/3/60	54,000	43	47	18	267	75	8.7	15	7/8	3/8

Ⓞ For coastal applications where units are installed within one (1) mile of salt water, epoxy coated models are available for order. Model numbers with "COT" in the eleventh (11) through thirteenth (13) digits represent an epoxy coated coil. Example: 4A6S6036A3COTA. These models have an 8 week lead time after order.

\* Information subject to change. Please confirm with current Product Data/Service Facts for current factory production.

\*\* Rated in accordance with AHRI Standard 270-2008 (Min/Max when applicable).

# Split System Heat Pumps Single Phase and Three Phase

**Table SH-10-A — Features**

	Gold 17 (4A6C7)	Silver 14 (4A6C4)	Silver 16 (4A6S6)
• SEER up to .....	17.5	15.5	16.0
• HSPF up to .....	9.60	9.50	10.0
• <b>Duration™</b> compressor .....	✓	✓	✓
• <b>Comfort-R™</b> mode approved .....	✓	✓	✓
• <b>DuraBase™</b> base, fast complete drain, weatherproof .....	✓	✓	✓
• <b>Easy-Sess™</b> cabinet, service access & refrigerant connections with full coil protection .....	✓	✓	✓
• <b>Spine Fin™</b> coil .....	✓	✓	✓
• <b>Copper/Aluminum</b> coil .....	✓	✓	✓
• Compressor sump heat - factory installed .....	✓	✓	✓
• Refrigerant .....	R-410A	R-410A	R-410A
• Glossy corrosion resistant finish .....	✓	✓	✓
• High pressure switch .....	✓	✓	✓
• Low pressure switch .....	✓	✓	✓
• Internal high / low pressure & temperature protection .....	✓	✓	✓
• Liquid line filter drier - factory supplied .....	✓	✓	✓
• Tarpaulin gray cabinet .....	✓	✓	✓
• <b>5-year basic limited warranty on compressor, 1-year on outdoor coil &amp; all other functional parts (Commercial Use)...</b>	✓	✓	✓
• <b>10-year limited warranty on compressor, outdoor coil &amp; all other functional parts with registration* (Residential Use).....</b>	—	—	✓
• <b>Extended warranties available.....</b>	✓	✓	✓

\* Registered Limited Warranty terms are available when you register within 60 days of installation. You can register online at americanstandardair.com or by phone at 855-260-2975, otherwise American Standard Heating & Air Conditioning's Base Limited Warranty terms will apply. Base Limited Warranty information on specific products can be found on ASDealerNet.com.

**Table SH-10-B — Optional Accessories**

Model Number	Description	Shipping Weight			
AY28X084.....	Evaporator Defrost Control HP .....	1.....	✓	✓	✓
BAYECMT004 .....	Extreme Conditions Mounting Kit (Base 4) .....	2.....	3-5	3-5	—
BAYISLT101 .....	Rubber Isolators .....	1.....	✓	✓	✓
BAYLEGS007 .....	Snow Legs - 7" High (Black) .....	1.....	✓	✓	✓
BAYLEGS004 .....	Snow Legs - 4" High (Black) .....	1.....	✓	✓	✓
BAYLOAM107A.....	Low Ambient Kit .....	1.....	✓	✓	—
BAYSDEN001 .....	Small Scroll Compressor Enclosures.....	8.....	—	3-3½	—
BAYSDEN004 .....	Large Scroll Compressor Enclosures .....	8.....	✓	4-5	4,5
BAYSEAC001.....	Seacoast Kit .....	1.....	✓	✓	—
TAYASCT501A①② .....	Anti-short cycle timer.....	2.....	✓	4	—
PAI00309③.....	Heresite Spraypaint.....	1.....	✓	—	✓
AAYSVPANL0032AA...	Service Valve Panel Cover Kit.....	2.....	—	3-3½	—
ATAYSVPANL0046AA ..	Service Valve Panel Cover Kit .....	2.....	3-5	5	—
AAYSVPANL3343AA .....	Service Valve Panel Cover Kit.....	2.....	—	4	—
BRK05033④.....	Wall Mount Kit .....	.....	—	—	✓
BAYTWGR0004 .....	<b>All Weather™ Top</b> - Fits unit base size of (W x D) of 37" X 34" .....	.....	✓	✓	—
BAYSDHG003A.....	Hail Guard Kit 4.3.....	.....	—	—	✓
BAYSDHG004A.....	Hail Guard Kit 4.4.....	.....	—	—	✓

**Comfort Controls — See Comfort Controls/Zone Sensors Section**

- ① Do not use with programmable thermostats.
- ② Activated on Power Off.
- ③ Used for additional seacoast corrosion protection. Refer to bulletin number UN-SVB11A-EN for application information.
- ④ Available from Trane Parts.

Split System Heat Pumps

# Features and Benefits

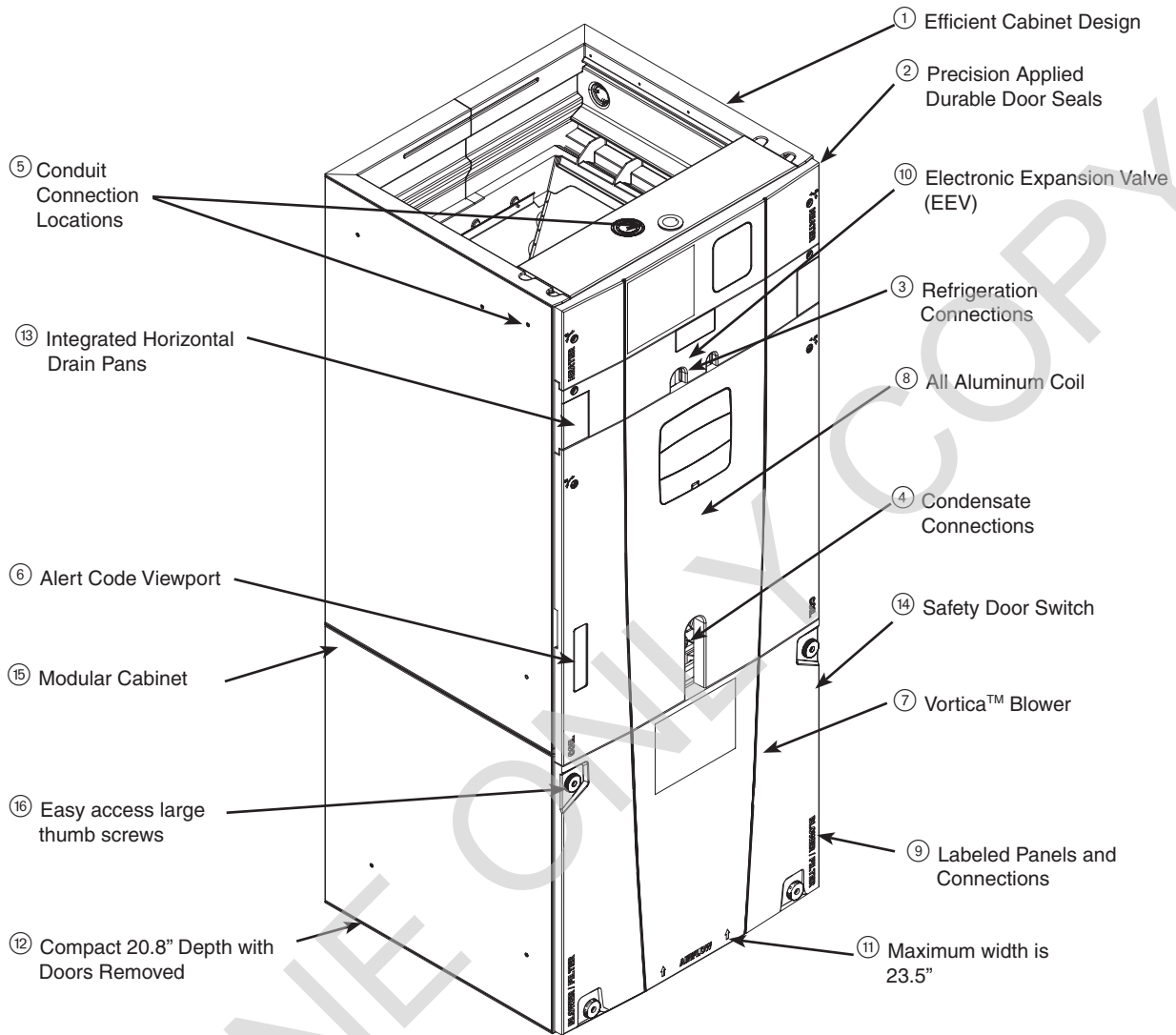

- ① Efficient Cabinet Design
  - Double wall foamed cabinet system
  - Waterproof Cabinet Design (No Thermal Breakage)
  - $\geq$  R-4.2 Insulating Value
  - Composite Cabinet Doors
  - Sweat Eliminating Cabinet Design
  - Loose Fiber Eliminating Design
  - Smooth Cleanable Cabinet Design
- ② Precision Applied Durable Door Seals
- ③ Refrigeration Connections
- ④ Condensate Connections
- ⑤ Conduit Connection Locations - Dimples in cabinet mark Conduit Connection Locations for Left, Right, and Top
- ⑥ Alert Code Viewport
  - Alert Codes can be Viewed Without Door Removal
  - Control Protection Pocket
- ⑦ Vortica™ Blower
  - Polarized Plug Connections
  - Integrated Slide Deck for Easy Removal
- ⑧ All Aluminum Coil
  - Integrated Slide Deck for Easy Removal
  - Polarized Plug connections on Coil EEV
  - Patented Enhanced Coil Fin
- ⑨ Labeled Panels and Connections
- ⑩ Electronic Expansion Valve (EEV)
  - Low Ambient and Low Superheat Compressor Protection
  - Dual Refrigerant Compatible as Shipped
- ⑪ Maximum width is 23.5"
- ⑫ Compact 20.8" Depth with Doors Removed
- ⑬ Integrated Horizontal Drain Pans
- ⑭ Safety Door Switch - Fused 24V Power
- ⑮ Modular Cabinet
- ⑯ Easy access large thumb screws

For complete equipment / combination selections, installation instructions and warranty information, please refer to Product Data/Ratings and/or Installers Guides and Limited Warranty Handbooks.



BUILT TO A HIGHER STANDARD<sup>®</sup>

*American Standard*<sup>®</sup>  
HEATING & AIR CONDITIONING

# Forefront TAM9 Variable Speed Multi-Position Air-Tite™ Air Handlers 2-5 Tons

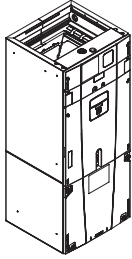

**Table AH-2-A — AccuLink™ II or 24V Variable Speed R-410A with Smart Fan Options 200-230/1/60, Epoxy Coated Coil**

Model Number	Cooling Capacity (Btuh)	Dimensions (in.) H x W x D	Shipping Weight (lbs.)	Supply Opening	Return Opening	Filter Sizes	Line Size (in)	
							Gas	Liquid
TAM9A0A24V21DA	24000	49.9 x 17.5 x 21.8	126	14.5 x 14.35	14.5 x 17.15	16 x 20 x 1	3/4	3/8
TAM9A0B30V31DA	30000	55.7 x 21.3 x 21.8	150	18.4 x 14.35	18.4 x 17.15	20 x 20 x 1	3/4	3/8
TAM9A0C36V31DA	36000	56.9 x 23.5 x 21.8	157	20.5 x 14.35	20.5 x 17.15	22 x 20 x 1	7/8	3/8
TAM9A0C42V41DA	42000	56.9 x 23.5 x 21.8	162	20.5 x 14.35	20.5 x 17.15	22 x 20 x 1	7/8	3/8
TAM9A0C48V41DA	48000	61.7 x 23.5 x 21.8	174	20.5 x 14.35	20.5 x 17.15	22 x 20 x 1	7/8	3/8
TAM9A0C60V51DA	60000	61.7 x 23.5 x 21.8	175	20.5 x 14.35	20.5 x 17.15	22 x 20 x 1	7/8	3/8

**Table AH-2-B — Features**

	TAM9 2-5
• Efficient cabinet design	✓
– 2% or less air leakage	✓
– Precision applied - durable door seals	✓
– Specially designed air seal around refrigerant, condensate and conduit connections	✓
– Double wall foamed cabinet system	✓
– ≥ R-4.2 insulating value	✓
– No loose fiber design	✓
– Smooth cleanable interior design	✓
– Sweat eliminating design	✓
– Composite cabinet doors	✓
– Water proof cabinet design	✓
– Integrated horizontal drain pans	✓
– Modular cabinet	✓
• Multi-position up/down flow horizontal left/right	✓
• Side return option (sold as accessory)	✓
• UVC light kit with safety switch and polarized plug connections (sold as accessory)	✓
• Control board protection pocket built into cabinet wall	✓
• Alert port to view control board codes without door removal	✓
• <b>ComfortLink™ II</b> or 24 Volt control	✓
• Alert code notification	✓
• 5 button user interface and clear description of set up	✓
• Service diagnostic with alert reported at user interface	✓
• Low voltage terminal connection point	✓
• <b>Vortica®</b> blower with polarized plug connections and integrated slide deck for easy removal	✓
• Aluminum coil with integrated slide deck for easy removal and polarized plug connections on coil EEV	✓
• Patented enhanced coil fin	✓
• Epoxy coated coil	✓
• Electronic Expansion Valve (EEV) with low ambient and low superheat compressor protection	✓
• Dual refrigerant compatible as shipped	✓
• Slide in electric heaters with polarized plug connections (sold as accessory)	✓
• Slide in hot water coils with polarized plug connections (sold as accessory)	✓
• Labeled panels and connections	✓
• Molded in 1" standard filter rail	✓
• Direct drive, variable speed ECM blower motor - Constant airflow ECM (electronically commutated motor)	✓
• Soft start fan motor operation	✓
• <b>Comfort R™</b> mode	✓
• Built in fan delay modes	✓
• Maximum width of 23.5"	✓
• Compact 20.8" depth with doors removed	✓
• Fused 24v power	✓
• Safety door switch	✓
• <b>10-year limited warranty/parts with registration*</b>	✓
• <b>10-year limited warranty/coil with registration*</b>	✓

\* Registered Limited Warranty terms are available when you register within 60 days of installation. You can register online at americanstandardair.com or by phone at 855-260-2975, otherwise American Standard Heating & Air Conditioning's Base Limited Warranty terms will apply. Base Limited Warranty information on specific products can be found on ASDealerNet.com.

For complete equipment / combination selections, installation instructions and warranty information, please refer to Product Data/Ratings and/or Installers Guides and Limited Warranty Handbooks.

# Forefront TAM9 Variable Speed Multi-Position Air-Tite™ Air Handlers 2-5 Tons

**Table AH-3-A — Optional Accessories**

Model Number	Description	Matches Cabinet Size(s)	TAM9
BAYWAAA05SC1AA	Hydronic Heater, Slide In, 40,000 BTUH, Nominal <sup>③</sup>	A	✓
BAYWABB07SC1AA	Hydronic Heater, Slide In, 50,000 BTUH, Nominal <sup>③</sup>	B	✓
BAYWACC08SC1AA	Hydronic Heater, Slide In, 65,000 BTUH, Nominal <sup>③</sup>	C	✓
BAYWACC11SC1AA	Hydronic Heater, 100,000 BTUH, Nominal, External Top Mount, No Control <sup>③</sup>	C	✓
BAYWAKIT24VAC	Hydronic Heater Relay Kit	C	✓
BAYSUPFLGAA	Supply Duct Flange A	A	✓
BAYSUPFLGBA	Supply Duct Flange B	B	✓
BAYSUPFLGCA	Supply Duct Flange C	C	✓
BAYRETFLGAA	Return Duct Flange A	A	✓
BAYRETFLGBA	Return Duct Flange B	B	✓
BAYRETFLGCA	Return Duct Flange C	C	✓
BAYUVCLK001	UVC Lights		✓
BAYFLR1620A	Washable high velocity filter, 16" x 20" x 1" (10 filters)	A	✓
BAYFLR2020A	Washable high velocity filter, 20" x 20" x 1" (10 filters)	B	✓
BAYFLR2220A	Washable high velocity filter, 22" x 20" x 1" (10 filters)	C	✓
TASB175SB <sup>②④</sup>	Plenum Stand with Integrated Sound Baffle A	A	✓
TASB215SB <sup>②④</sup>	Plenum Stand with Integrated Sound Baffle B	B	✓
TASB235SB <sup>②④</sup>	Plenum Stand with Integrated Sound Baffle C	C	✓
MTISRKIT1620 <sup>②</sup>	Side Return Kit with 16"x20" Filter	A-C	✓
BAYSRKIT100	Side Return Kit	A-C	✓
BAYFRKIT175	Front Return Kit	A	✓
BAYFRKIT210	Front Return Kit	B	✓
BAYFRKIT235	Front Return Kit	C	✓
TASSBK175 <sup>②④⑥</sup>	Sound Baffle Kit 17.5" Cabinet	A	✓
TASSBK215 <sup>②④⑥</sup>	Sound Baffle Kit 21.5" Cabinet	B	✓
TASSBK235 <sup>②④⑥</sup>	Sound Baffle Kit 23.5" Cabinet	C	✓
BAYSPEKT200	Single Power Entry Kit		✓
TAYBASETAMA	Downflow Sub-Base Kit	A-C	✓
BAYICKSKIT01	Internal Condensate Switch Kit		✓
BAYHHKIT001	Horizontal Hanger Kit		✓
BAYLVKIT100	Low Voltage Conduit Entry Kit		✓
BAYAHEMIKIT001	Air handler Electronic Noise Kit used on Variable Speed Blower Motor		✓
BAYBAFKT175A <sup>⑦</sup>	Sound Baffle Kit 17.5" Cabinet	A	✓
BAYBAFKT215A <sup>⑦</sup>	Sound Baffle Kit 21.5" Cabinet	B	✓
BAYBAFKT235A <sup>⑦</sup>	Sound Baffle Kit 23.5" Cabinet	C	✓
BAYINSKT175A	Sound Insulation Kit 17.5" Cabinet	A	✓
BAYINSKT215A	Sound Insulation Kit 21.5" Cabinet	B	✓
BAYINSKT235A	Sound Insulation Kit 17.5" through 23.5" Cabinet	A-C	✓
BAYCNDPIP01A	3/4" PVC Threaded Pipe Kit with foam seal (10 kits)		✓

① A Cabinet is 17.5" wide, B Cabinet is 21.5" wide, C Cabinet is 23.5" wide.  
 ② Contact your distributor for information.  
 ③ ACONT900 Thermostat can not be used with Hydronic heating.  
 ④ In return plenum applications, use TASSBK kits for sound reduction.  
 ⑤ In open air applications, Plenum Stand with Sound Baffle provides sound reduction.  
 ⑥ Mounts to TASB original plenum stands without integrated sound baffle.  
 ⑦ Mounts inside air filter channel on air handler.

BUILT TO A HIGHER STANDARD<sup>®</sup>

*American Standard*<sup>®</sup>

HEATING & AIR CONDITIONING

# Multi-position Air Handler

\* Note: No internal modifications required for any position.

① Badge rotation will keep brand in correct position

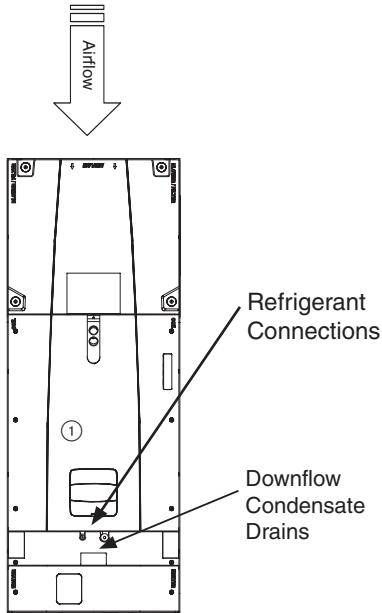

Vertical Downflow\*

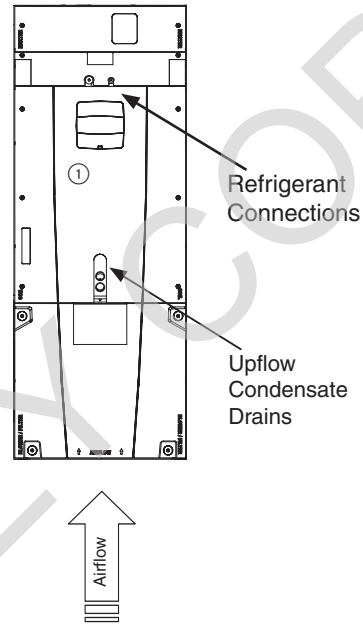

Vertical Upflow\*  
(as shipped)

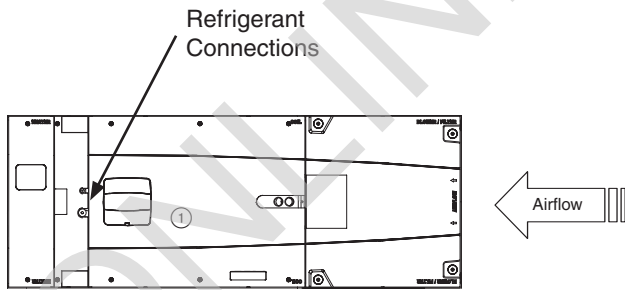

Horizontal Left\*

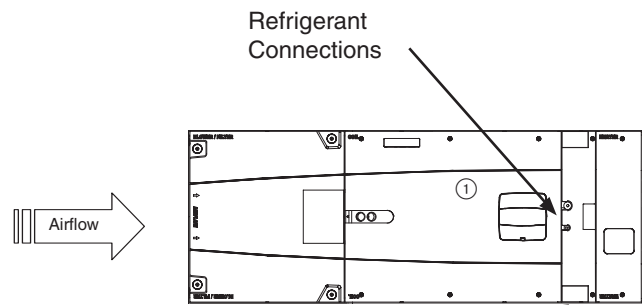

Horizontal Right\*

# Forefront GAM5 Multi-Position Air Handlers Single Phase 1½-5 Tons

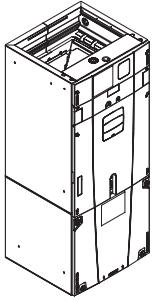

**Table AH-5-A — Multi-Speed High Efficiency Motor 200-230/1/60, Epoxy Coated Coil**

Model Number	Cooling Capacity (Btuh)	Dimensions (in.) H x W x D	Shipping Weight (lbs.)	Supply Opening	Return Opening	Filter Sizes	Line Size (in)	
							Gas	Liquid
GAM5B0A18M11EA	18000	49.9 x 17.5 x 21.8	126	14.5 x 14.35	14.5 x 17.15	16 x 20 x 1	¾	⅜
GAM5B0A24M21EA	24000	49.9 x 17.5 x 21.8	126	14.5 x 14.35	14.5 x 17.15	16 x 20 x 1	¾	⅜
GAM5B0B30M21EA	30000	51.5 x 21.3 x 21.8	140	18.4 x 14.35	18.4 x 17.15	20 x 20 x 1	¾	⅜
GAM5B0B36M31EA	36000	55.7 x 21.3 x 21.8	150	18.4 x 14.35	18.4 x 17.15	20 x 20 x 1	7/8	⅜
GAM5B0C42M31EA	42000	56.9 x 23.5 x 21.8	163	20.5 x 14.35	20.5 x 17.15	22 x 20 x 1	7/8	⅜
GAM5B0C48M41EA	48000	61.7 x 23.5 x 21.8	176	20.5 x 14.35	20.5 x 17.15	22 x 20 x 1	7/8	⅜
GAM5B0C60M51EA	60000	61.7 x 23.5 x 21.8	180	20.5 x 14.35	20.5 x 17.15	22 x 20 x 1	7/8	⅜

**Table AH-5-B — Features**

	GAM5 1 1/2-5
• Efficient cabinet design	✓
– 2% or less air leakage	✓
– Precision applied - durable door seals	✓
– Specially designed air seal around refrigerant, condensate and conduit connections	✓
– Double wall foamed cabinet system	✓
– ≥ R-4.2 insulating value	✓
– No loose fiber design	✓
– Smooth cleanable interior design	✓
– Sweat eliminating design	✓
– Composite cabinet doors	✓
– Water proof cabinet design	✓
– Integrated horizontal drain pans	✓
– Modular cabinet	✓
• Multi-position up/down flow horizontal left/right	✓
• Side return option (sold as accessory)	✓
• UVC light kit with safety switch and polarized plug connections (sold as accessory)	✓
• Low voltage pigtail connections	✓
• <b>Vortica</b> ® blower with polarized plug connections and integrated slide deck for easy removal	✓
• Aluminum coil with integrated slide deck for easy removal	✓
• Patented enhanced coil fin	✓
• Epoxy coated coil	✓
• R-410A TXV	✓
• Slide in electric heaters with polarized plug connections (sold as accessory)	✓
• Labeled panels and connections	✓
• Molded in 1" standard filter rail	✓
• Direct drive, multi speed ECM blower motor - Constant torque ECM (electronically commutated motor)	✓
• Maximum width of 23.5"	✓
• Compact 20.8" depth with doors removed	✓
• Fused 24v power	✓
• Safety door switch	✓
• <b>10-year limited warranty/parts with registration*</b>	✓
• <b>10-year limited warranty/coil with registration*</b>	✓

\* Registered Limited Warranty terms are available when you register within 60 days of installation. You can register online at [americanstandardair.com](http://americanstandardair.com) or by phone at 855-260-2975, otherwise American Standard Heating & Air Conditioning's Base Limited Warranty terms will apply. Base Limited Warranty information on specific products can be found on [ASDealerNet.com](http://ASDealerNet.com).

# Forefront GAM5 Multi-Position Air Handlers Single Phase 1½-5 Tons

**Table AH-6-A — Optional Accessories**

Model Number	Description	Matches Cabinet Size(s)	GAM5
BAYWAAA05SC1AA	Hydronic Heater, 40,000 BTUH, Nominal, Slide-in, No Control	A	✓
BAYWABB07SC1AA	Hydronic Heater, 50,000 BTUH, Nominal, Slide-in, No Control	B	✓
BAYWACC08SC1AA	Hydronic Heater, 65,000 BTUH, Nominal, Slide-in, No Control	C	✓
BAYWACC11SC1AA	Hydronic Heater, 100,000 BTUH, Nominal, External Top Mount, No Control <sup>⑦</sup>	C	✓
BAYSUPFLGAA	Supply Duct Flange A	A	✓
BAYSUPFLGBA	Supply Duct Flange B	B	✓
BAYSUPFLGCA	Supply Duct Flange C	C	✓
BAYRETLGAA	Return Duct Flange A	A	✓
BAYRETLGBA	Return Duct Flange B	B	✓
BAYRETLGCA	Return Duct Flange C	C	✓
BAYUVCLK001	UV Lights		✓
BAYFLR1620A	Washable high velocity filter, 16" x 20" x 1" (10 filters)	A	✓
BAYFLR2020A	Washable high velocity filter, 20" x 20" x 1" (10 filters)	B	✓
BAYFLR2220A	Washable high velocity filter, 22" x 20" x 1" (10 filters)	C	✓
TASB175SB <sup>②④</sup>	Plenum Stand with Integrated Sound Baffle A	A	✓
TASB215SB <sup>②④</sup>	Plenum Stand with Integrated Sound Baffle B	B	✓
TASB235SB <sup>②④</sup>	Plenum Stand with Integrated Sound Baffle C	C	✓
MTISRKIT1620 <sup>②</sup>	Side Return Kit with 16"x20" Filter	A-C	✓
TASSBK175 <sup>②③⑤</sup>	Sound Baffle Kit 17.5" Cabinet	A	✓
TASSBK215 <sup>②③⑤</sup>	Sound Baffle Kit 21.5" Cabinet	B	✓
TASSBK235 <sup>②③⑤</sup>	Sound Baffle Kit 23.5" Cabinet	C	✓
BAYSPEKT200	Single Power Entry Kit		✓
BAYSRKIT100	Side Return Kit	A-C	✓
BAYFRKIT175	Front Return Kit	A	✓
BAYFRKIT210	Front Return Kit	B	✓
BAYFRKIT235	Front Return Kit	C	✓
BAYHHKIT001	Horizontal Hanger Kit		✓
BAYLVKIT100A	Low Voltage Conduit Entry Kit		✓
BAYAHEMIKIT001	Air handler Electronic Noise Kit used on Variable Speed Blower Motor		✓
BAYBAFKT175A <sup>⑥</sup>	Baffle Kit 17.5" Cabinet	A	✓
BAYBAFKT215A <sup>⑥</sup>	Baffle Kit 21.5" Cabinet	B	✓
BAYBAFKT235A <sup>⑥</sup>	Baffle Kit 23.5" Cabinet	C	✓
BAYINSKT175A	Sound Insulation Kit 17.5" Cabinet	A	✓
BAYINSKT215A	Sound Insulation Kit 21.5" Cabinet	B	✓
BAYINSKT235A	Sound Insulation Kit 17.5" through 23.5" Cabinet	A-C	✓
BAYCNDPIP01A	3/4" PVC Threaded Pipe Kit with foam seal (10 kits)		✓
Model Number	Description		GAM5B
BAYATXV1836A	R-22 TXV conversion kit		1½-2
BAYATXV4248A	R-22 TXV conversion kit		2½-3½
BAYATXV6060A	R-22 TXV conversion kit		4-5

- ① A Cabinet is 17.5" wide, B Cabinet is 21.5" wide, C Cabinet is 23.5" wide.
- ② Contact your distributor for information.
- ③ In return plenum applications, use TASSBK kits for sound reduction.
- ④ In open air applications, Plenum Stand with Sound Baffle provides sound reduction.
- ⑤ Mounts to TASB original plenum stands without integrated sound baffle.
- ⑥ Mounts inside air filter channel on air handler.
- ⑦ ACONT900 Thermostat can not be used with Hydronic heating.

# ForeFront GAF2 Split System Air Handlers Single Phase 2-3 Tons

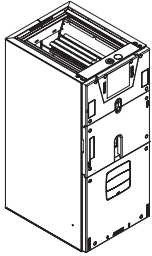

**Table AH-7-A — Multi-Speed PSC Motor 200-230/1/60, Epoxy Coated Coil**

Model Number	Cooling Capacity (Btuh)	Dimensions (in.) H x W x D	Shipping Weight (lbs.)	Supply Opening	Return Opening	Filter Sizes	Line Size (in)	
							Gas	Liquid
GAF2A0A24S21EE	24000	39.5 x 17.5 x 21.8	120	14.5 x 16.75	14.5 x 17.8	N/A	3/4	3/8
GAF2A0A30S21EE	30000	39.5 x 17.5 x 21.8	121	14.5 x 16.75	14.5 x 17.8	N/A	3/4	3/8

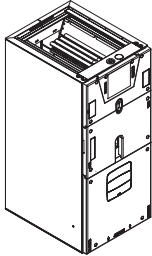

**Table AH-7-B — Multi-Speed High Efficiency ECM Motor 200-230/1/60, Epoxy Coated Coil** ①

Model Number	Cooling Capacity (Btuh)	Dimensions (in.) H x W x D	Shipping Weight (lbs.)	Supply Opening	Return Opening	Filter Sizes	Line Size (in)	
							Gas	Liquid
GAF2A0A36M31EC	36000	39.5 x 17.5 x 21.8	118	14.5 x 14.35	14.5 x 17.15	N/A	3/4	3/8

**Table AH-7-C — Features**

	GAF2 2-3
• Unique cabinet design.....	✓
– 2% or less air leakage.....	✓
– Precision applied - durable door seals.....	✓
– Specially designed air seal around refrigerant, condensate and conduit connections.....	✓
– Double wall foamed cabinet system.....	✓
– ≥ R-4.2 insulating value (Avg. Insulating Value R-8.2).....	✓
– No loose fiber design.....	✓
– Smooth cleanable interior design.....	✓
– Sweat eliminating design.....	✓
– Composite cabinet doors.....	✓
– Water proof cabinet design.....	✓
– Integrated horizontal drain pans.....	✓
• 3 way conversion up flow/horizontal left/right.....	✓
• Front return option.....	✓
• Low voltage pigtail connections.....	✓
• <b>Vortica</b> ® blower with polarized plug connections and integrated slide deck for easy removal.....	✓
• Aluminum coil with integrated slide deck for easy removal and polarized plug connections on coil EEV (GAF2A0A36M31).....	3
• Patented enhanced coil fin.....	✓
• Epoxy coated coil.....	✓
• R-410A TXV.....	✓
• Labeled panels and connections.....	✓
• PSC 3 speed motor.....	✓
• Direct drive, multi speed ECM blower motor - Constant torque ECM (electronically commutated motor) (GAF2A0A36M31).....	3
• Maximum width of 23.5".....	✓
• Compact 20.8" depth with doors removed.....	✓
• Fused 24v power.....	✓
• <b>10-year limited warranty/parts with registration*</b> .....	✓
• <b>10-year limited warranty/coil with registration*</b> .....	✓

\* Registered Limited Warranty terms are available when you register within 60 days of installation. You can register online at americanstandardair.com or by phone at 855-260-2975, otherwise American Standard Heating & Air Conditioning's Base Limited Warranty terms will apply. Base Limited Warranty information on specific products can be found on ASDealerNet.com.

# Forefront GAF2 Split System Air Handlers Single Phase 2-3 Tons

**Table AH-8-A — Optional Accessories**

Model Number	Description	GAF2 ①
BAYATXV1836	R-22 TXV conversion kit 1-1/2 to 3 ton	✓
BAYBRFBX100	Bottom Return Filter Box	✓
BAYFRKIT100	Front Return Kit	✓
BAYICKSKIT01	Internal Condensate Switch Kit (GAF2A0A36M311SA)	3
BAYLVKIT100	Low Voltage Conduit Entry Kit	✓
BAYRETFLGAA	Return Duct Flange A, A1	✓
BAYSFSCABAA	Supply Duct Flange A1	✓
BAYAHEMIKIT001	Air handler Electronic Noise Kit used on Variable Speed Blower Motor	✓
BAYSRKIT100	Side Return Kit	✓
BAYWMKIT001	Wall Mount Kit	✓
TASB175SB②④	Plenum Stand with Integrated Sound Baffle A	✓
MTISRKIT1620②	Side Return Kit with 16"x20" Filter	✓
TASSBK175②③	Sound Baffle Kit 17.5" Cabinet (mounts to TASB plenum stands)	✓
BAYECPDKIT1	Pull disconnect kit	✓
BAYBAFKT175A	Baffle Kit 17.5" Cabinet (mounts in air handler filter channel)	✓
BAYINSKT235A	Sound Insulation Kit 17.5" through 23.5" Cabinet	✓
BAYCNDPIP01A	3/4" PVC Threaded Pipe Kit with foam seal (10 kits)	✓

- ① The A1 one-piece 17.5" wide cabinet is used on the GAF2 air handlers only.
- ② Contact your distributor for information.
- ③ In return plenum applications, use TASSBK kits for sound reduction.
- ④ In open air applications, Plenum Stand with Sound Baffle provides sound reduction.

# Heaters for Multi-Position Air Handlers

**Table AH-9-A — BAYEA — Heater, Standard, for Forefront TAM9 and GAM5 Air Handlers**

Heater Model Number	Capacity @ 240 Volts		Capacity @ 208 Volts		Rated Voltage	Control Stages	Number of Heater Racks	Number of Circuits	Heater Amps per Circuit		Contains Circuit Breakers
	kW	BTUH	kW	BTUH					208 Volts	240Volt	
BAYEAAC04BK1BB	3.84	13100	2.88	9800	208/240/1/60	1	1	1	13.8	16	Yes
BAYEAAC04LG1BB	3.84	13100	2.88	9800	208/240/1/60	1	1	1	13.8	16	No
BAYEAAC05BK1BB	4.80	16400	3.60	12300	208/240/1/60	1	1	1	17.3	20	Yes
BAYEAAC05LG1BB	4.80	16400	3.60	12300	208/240/1/60	1	1	1	17.3	20	No
BAYEAAC08BK1BB	7.68	26200	5.76	19700	208/240/1/60	2	2	1	27.7	32	Yes
BAYEAAC08LG1BB	7.68	26200	5.76	19700	208/240/1/60	2	2	1	27.7	32	No
BAYEAAC10NK1BB	9.60	32800	7.20	24600	208/240/1/60	2	2	1	34.6	40	Yes
BAYEAAC10LG1BB	9.60	32800	7.20	24600	208/240/1/60	2	2	1	34.6	40	No
BAYEABC15BK1BB	14.40	49200	10.80	36900	208/240/1/60	3	3	2	34.6/17.3	40/20	Yes
BAYEABC20BK1BB	19.20	65600	14.40	49200	208/240/1/60	3	4	2	34.6/34.6	40/40	Yes
BAYEACC25BK1BB	24.00	82000	18.00	61500	208/240/1/60	3	5	3	34.6/34.6/17.3	40/40/20	Yes

BK = Contains circuit breakers  
 LG = Contains lug connections

**Table AH-9-B — BAYEC — Heater, Compact, with Lugs, for GAF2 Air Handlers**

Heater Model Number	Capacity @ 240 Volts		Capacity @ 208 Volts		Rated Voltage	Control Stages	Number of Heater Racks	Number of Circuits	Heater Amps per Circuit		Contains Circuit Breakers
	kW	BTUH	kW	BTUH					208 Volts	240Volt	
BAYECAA05LG1BA	4.80	16400	3.60	12300	208/240/1/60	1	1	1	17.3	20	No
BAYECAA08LG1BA	7.68	26200	5.76	19700	208/240/1/60	2	2	1	27.7	32	No
BAYECAA10LG1BA	9.60	32800	7.20	24600	208/240/1/60	2	2	1	34.6	40	No

BAYECPDKIT1 - Optional pull disconnect used with BAYEC heaters only

**Table AH-9-C — BAYEA — Heater, 3-Phase, for Forefront TAM9 and GAM5 Air Handlers <sup>①</sup>**

Heater Model Number	Capacity @ 240 Volts		Capacity @ 208 Volts		Rated Voltage	Control Stages	Number of Heater Racks	Number of Circuits	Heater Amps per Circuit		Contains Circuit Breakers
	kW	BTUH	kW	BTUH					208 Volts	240Volt	
BAYEAAC10LG3BB	9.60	32800	7.20	24600	208/240/3/60	1	3	1	20.0	23.1	No
BAYEABC15LG3BB	14.40	49200	10.80	36900	208/240/3/60	1	3	1	30.0	34.6	No

<sup>①</sup> 3-Phase - W1, W2, W3 must be jumpered at low voltage connector



# Heaters for Multi-Position Air Handlers

**Table AH-10-A — Air Handler/Heater Matrix**

AIR HANDLER  MODEL NUMBER	HEATER MODEL NUMBER BAYEA-										
	AC04BK1BB 3.84 Kw BK	AC04LG1BB 3.84 Kw LG	AC05BK1BB 4.80 Kw BK	AC05LG1BB 4.80 Kw LG	AC08BK1BB 7.68 Kw BK	AC08LG1BB 7.68 Kw LG	AC10BK1BB 9.60 Kw BK	AC10LG1BB 9.60 Kw LG	BC15BK1BB 14.40 Kw BK	BC20BK1BB 19.20 Kw BK	CC25BK1BB 24.00 Kw BK
TAM9A0A24V21	Y	Y	Y	Y	Y	Y	Y	Y	—	—	—
TAM9A0B30V31	Y	Y	Y	Y	Y	Y	Y	Y	Y	—	—
TAM9A0C36V31	Y	Y	Y	Y	Y	Y	Y	Y	Y	Y	—
TAM9A0C42V41	Y	Y	Y	Y	Y	Y	Y	Y	Y	Y	—
TAM9A0C48V41	Y	Y	Y	Y	Y	Y	Y	Y	Y	Y	Y
TAM9A0C60V51	Y	Y	Y	Y	Y	Y	Y	Y	Y	Y	Y
GAM5B0A18M11	Y	Y	Y	Y	Y	Y	Y	Y	—	—	—
GAM5B0A24M21	Y	Y	Y	Y	Y	Y	Y	Y	—	—	—
GAM5B0B30M21	Y	Y	Y	Y	Y	Y	Y	Y	Y	—	—
GAM5B0B36M31	Y	Y	Y	Y	Y	Y	Y	Y	Y	—	—
GAM5B0C42M31	Y	Y	Y	Y	Y	Y	Y	Y	Y	—	—
GAM5B0C48M41	Y	Y	Y	Y	Y	Y	Y	Y	Y	Y	Y
GAM5B0C60M51	Y	Y	Y	Y	Y	Y	Y	Y	Y	Y	Y

BK = Contains circuit breakers  
LG = Contains lug connections

**Table AH-10-B — Air Handler/Heater Matrix (continued)**

AIR HANDLER  MODEL NUMBER	3 PHASE HEATER MODEL NUMBER BAYEA-		AIR HANDLER  MODEL NUMBER	HEATER MODEL NUMBER BAYEC-		
	AC10LG3BB 9.60 Kw LG	BC15LG3BB 9.60 Kw LG		AA05LG1BA 4.80 Kw BK	AA08LG1BA 7.68 Kw LG	AA10LG1BA 9.60 Kw LG
TAM9A0A24V21	Y	—	GAF2A0A24S21	Y	—	Y
TAM9A0B30V31	Y	Y	GAF2A0A30S21	Y	Y	Y
TAM9A0C36V31	Y	Y	GAF2A0A36M31	Y	Y	Y
TAM9A0C42V41	Y	Y	GAF2A0A36S3A	Y	Y	Y
TAM9A0C48V41	Y	Y				
TAM9A0C60V51	Y	Y				
GAM5B0A18M11	Y	—				
GAM5B0A24M21	Y	—				
GAM5B0B30M21	Y	Y				
GAM5B0B36M31	Y	Y				
GAM5B0C42M31	Y	Y				
GAM5B0C48M41	Y	Y				
GAM5B0C60M51	Y	Y				
TAM4A0A18S11	Y	—				
TAM4A0A24S21	Y	—				
TAM4A0A30S21	Y	Y				
TAM4A0A36S31	Y	Y				
TAM4A0B42S31	Y	Y				
TAM4A0C48S41	Y	Y				
TAM4A0C60S51	Y	Y				

LG = Contains lug connections

# TEM Split System Air Handlers Single Phase 1½-5 Tons

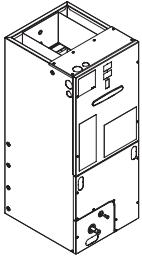

**Table AH-11-A — R-410A AccuLink™ II or 24V Variable Speed Air Handler 208-230/1/60**

Model Number	Cooling Capacity (Btuh)	Dimensions (in.) H x W x D	Shipping Weight (lbs.)	Supply Opening	Return Opening	Filter Sizes	Line Size (in)	
							Gas	Liquid
TEM8A0B24V21DB	24000	46.75 x 18.5 x 21.13	126	16.5 x 12.15	16.75 x 18.75	①	¾	⅜
TEM8A0B30V31DB	30000	46.75 x 18.5 x 21.13	126	16.5 x 12.15	16.75 x 18.75	①	¾	⅜
TEM8A0C36V31DB	36000	51.27 x 23.5 x 21.13	155	21.5 x 12.15	21.75 x 18.75	①	7/8	⅜
TEM8A0C42V41DB	42000	51.27 x 23.5 x 21.13	155	21.5 x 12.15	21.75 x 18.75	①	7/8	⅜
TEM8A0C48V41DB	48000	55.75 x 23.5 x 21.13	185	21.5 x 12.15	21.75 x 18.75	①	7/8	⅜
TEM8A0D48V41DB	48000	53.87 x 26.5 x 21.13	181	24.5 x 12.15	24.75 x 18.75	①	7/8	⅜
TEM8A0C60V51DB	60000	55.75 x 23.5 x 21.13	185	21.5 x 12.15	21.75 x 18.75	①	7/8	⅜
TEM8A0D60V51DB	60000	53.87 x 26.5 x 21.13	181	24.5 x 12.15	24.75 x 18.75	①	7/8	⅜

① Filter not supplied. Remote filter required.

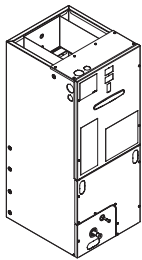

**Table AH-11-B — R-410A Convertible Variable Speed Air Handler 208-230/1/60**

Model Number	Cooling Capacity (Btuh)	Dimensions (in.) H x W x D	Shipping Weight (lbs.)	Supply Opening	Return Opening	Filter Sizes	Line Size (in)	
							Gas	Liquid
TEM6A0B24H21SB	24000	46.75 x 18.5 x 21.13	126	16.5 x 12.15	16.75 x 18.75	①	¾	⅜
TEM6A0B30H21SB	30000	46.75 x 18.5 x 21.13	126	16.5 x 12.15	16.75 x 18.75	①	¾	⅜
TEM6A0C36H31SB	36000	51.27 x 23.5 x 21.13	155	21.5 x 12.15	21.75 x 18.75	①	7/8	⅜
TEM6A0C42H41SB	42000	51.27 x 23.5 x 21.13	155	21.5 x 12.15	21.75 x 18.75	①	7/8	⅜
TEM6A0C48H41SB	48000	55.75 x 23.5 x 21.13	185	21.5 x 12.15	21.75 x 18.75	①	7/8	⅜
TEM6A0D48H41SB	48000	53.87 x 26.5 x 21.13	181	24.5 x 12.15	24.75 x 18.75	①	7/8	⅜
TEM6A0C60H51SB	60000	55.75 x 23.5 x 21.13	185	21.5 x 12.15	21.75 x 18.75	①	7/8	⅜
TEM6A0D60H51SB	60000	53.87 x 26.5 x 21.13	181	24.5 x 12.15	24.75 x 18.75	①	7/8	⅜

① Filter not supplied. Remote filter required.

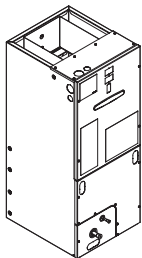

**Table AH-11-C — R-410A Convertible Air Handler 208-230/1/60**

Model Number	Cooling Capacity (Btuh)	Dimensions (in.) H x W x D	Shipping Weight (lbs.)	Supply Opening	Return Opening	Filter Sizes	Line Size (in)	
							Gas	Liquid
TEM4A0B18S21SB	18000	45.02 x 18.5 x 21.13	116	16.5 x 12.15	16.75 x 18.75	①	¾	⅜
TEM4A0B24S21SB	24000	45.02 x 18.5 x 21.13	116	16.5 x 12.15	16.75 x 18.75	①	¾	⅜
TEM4A0B30S31SB	30000	45.02 x 18.5 x 21.13	116	16.5 x 12.15	16.75 x 18.75	①	¾	⅜
TEM4A0B36S31SB	36000	45.02 x 18.5 x 21.13	116	16.5 x 12.15	16.75 x 18.75	①	¾	⅜
TEM4A0C37S31SB	36000	51.27 x 23.5 x 21.13	145	21.5 x 12.15	21.75 x 18.75	①	7/8	⅜
TEM4A0C42S41SB	42000	51.27 x 23.5 x 21.13	145	21.5 x 12.15	21.75 x 18.75	①	7/8	⅜
TEM4A0C48S41SB	48000	51.27 x 23.5 x 21.13	145	21.5 x 12.15	21.75 x 18.75	①	7/8	⅜
TEM4A0C60S51SB	60000	51.27 x 23.5 x 21.13	145	21.5 x 12.15	21.75 x 18.75	①	7/8	⅜
TEM4A0B19M21SA	24000	45.02 x 18.5 x 21.13	116	16.5 x 12.15	16.75 x 18.75	①	¾	⅜
TEM4A0B31M31SA	30000	46.75 x 18.5 x 21.13	126	16.5 x 12.15	16.75 x 18.75	①	¾	⅜
TEM4A0C43M41SA	42000	51.27 x 23.5 x 21.13	155	21.5 x 12.15	21.75 x 18.75	①	7/8	⅜
TEM4A0C49M41SA	48000	55.75 x 23.5 x 21.13	185	21.5 x 12.15	21.75 x 18.75	①	7/8	⅜
TEM4A0C61M51SA	60000	55.75 x 23.5 x 21.13	185	21.5 x 12.15	21.75 x 18.75	①	7/8	⅜

① Filter not supplied. Remote filter required.

# TEM Split System Air Handlers Single Phase 1½-5 Tons

**Table AH-12-A — Features**

	TEM8 2-5	TEM6 2-5	TEM4 1 1/2-5
• Painted metal cabinet with captured foil face insulation	✓	✓	✓
• 2% or less air leakage	✓	✓	✓
• <b>AccuLink™ II</b> or 24V operation	✓	—	—
• Direct drive, variable speed ECM blower motor - Constant airflow ECM (electronically commutated)	✓	—	—
• Direct drive, multi speed ECM blower motor - Constant torque ECM (electronically commutated motor)	—	—	✓ <sup>①</sup>
• PSC Motor	—	—	✓ <sup>②</sup>
• R-4.2 Insulating Value	✓	✓	✓
• Multi-Position UP/Down Flow*, Horizontal Left /Right	✓	✓	✓
• ALL Aluminum Coil with Enhanced Patented Coil Fin	✓	✓	✓
• Electric Heaters with polarized plug connections (sold as accessory)	✓	✓	✓
• R-410A Thermal Expansion Valve	✓	✓	✓
• Low Voltage Pigtail Connections	✓	✓	✓
• Draw Through Design	✓	✓	✓
• Horizontal Drain pan	✓	✓	✓
• Single Color	✓	✓	✓
• Fused 24V Power	✓	✓	✓
• Wipeable interior design	✓	✓	✓
• Soft start fan motor operation	✓	✓	—
• <b>Comfort R™</b> mode	✓	✓	—
• Built in fan delay modes	✓	✓	—
• Maximum Width 26.5"	✓	✓	—
• Maximum Width 23.5"	—	—	✓
• Compact 22" depth	✓	✓	✓
• Draw through design	✓	✓	✓
• <b>10-year limited warranty/parts with registration*</b>	✓	✓	✓
• <b>10-year limited warranty/coil with registration*</b>	✓	✓	✓

① For TEM4: direct drive, multi speed ECM blower motor - Constant torque ECM 19, 31, 43, 49, 61

② For TEM4: PSC Motor 1½-3

\* Registered Limited Warranty terms are available when you register within 60 days of installation. You can register online at americanstandardair.com or by phone at 855-260-2975, otherwise American Standard Heating & Air Conditioning's Base Limited Warranty terms will apply. Base Limited Warranty information on specific products can be found on ASDealerNet.com.

**Table AH-12-B — Optional Accessories**

Model Number	Description	Matches Cabinet Size(s)	TEM8	TEM6	TEM4
BAYTEMSPFG1	Supply Duct Flange Kit		✓	✓	✓
BAYSPEKT201A	Single Point Power Entry Kit		✓	✓	✓
TAYBASE185	Air Handler Downflow Sub-Bases	18.5"	✓	✓	✓
TAYBASE235 (TAYBASE100)	Air Handler Downflow Sub-Bases	23.5"	✓	✓	✓
TAYBASE102	Air Handler Downflow Sub-Bases	26.5"	✓	✓	—
BAYTEMDFKT1A	Downflow Condensate Management Kit	23.5" ①	—	—	✓
BAYAHEMIKIT001	Air handler Electronic Noise Kit used on Variable Speed Blower Motor		✓	✓	✓
TEMBRKSEALKT01A	TEM Breaker Seal Kit		✓	✓	✓
BAYSF1185AAA	Slim Fit Filter Box Kit	18.5"	✓	✓	✓
BAYSF1235AAA	Slim Fit Filter Box Kit	23.5"	✓	✓	✓
BAYSF1265AAA	Slim Fit Filter Box Kit	26.5"	✓	✓	—
FLRSF1185	1" Slim Fit Replacement Filter, 17.75"x19.75", Qty 12	18.5"	✓	✓	✓
FLRSF1235	1" Slim Fit Replacement Filter, 22.75"x19.75", Qty 12	23.5"	✓	✓	✓
FLRSF1265	1" Slim Fit Replacement Filter, 25.75"x19.75", Qty 12	26.5"	✓	✓	—
BAY6TXV2442A	R-22 TXV conversion kit		2-3½	2-3½	—
BAY6TXV4860A	R-22 TXV conversion kit		4-5 <sup>②</sup>	4-5 <sup>②</sup>	—
BAYATXV1836B	R-22 TXV conversion kit		—	—	1½-2½
BAYATXV4248B	R-22 TXV conversion kit		—	—	3-4
BAYATXV6161B	R-22 TXV conversion kit		4-5 <sup>③</sup>	4-5 <sup>③</sup>	5

① Downflow condensate management kit is required for 5 Ton downflow models.

② TEM6A0D48, TEM6A0D60, TEM8A0D48, TEM8A0D60

③ TEM6A0C48, TEM6A0C60, TEM8A0C48, TEM8A0C60

For complete equipment / combination selections, installation instructions and warranty information, please refer to Product Data/Ratings and/or Installers Guides and Limited Warranty Handbooks.

# Heaters for TEM Split System Air Handlers

**Table AH-13-A — BAYHTR15 — Heater, Standard, for TEM Air Handlers**

Heater Model Number	Capacity @ 240 Volts		Capacity @ 208 Volts		Rated Voltage	Control Stages	Number of Heater Racks	Number of Circuits	Heater Amps per Circuit		Contains Circuit Breakers
	kW	BTUH	kW	BTUH					208 Volts	240Volt	
BAYHTR1504BRKC	3.84	13100	2.88	9800	208/240/1/60	1	1	1	13.8	16	Yes
BAYHTR1504LUGB	3.84	13100	2.88	9800	208/240/1/60	1	1	1	13.8	16	No
BAYHTR1505BRKC	4.80	16400	3.60	12300	208/240/1/60	1	1	1	17.3	20	Yes
BAYHTR1505LUGB	4.80	16400	3.60	12300	208/240/1/60	1	1	1	17.3	20	No
BAYHTR1508BRKC	7.68	26200	5.76	19700	208/240/1/60	1	1	1	27.7	32	Yes
BAYHTR1508LUGB	7.68	26200	5.76	19700	208/240/1/60	1	1	1	27.7	32	No
BAYHTR1510BRKC	9.60	32800	7.20	24600	208/240/1/60	1	2	1	34.6	40	Yes
BAYHTR1510LUGB	9.60	32800	7.20	24600	208/240/1/60	1	2	1	34.6	40	No
BAYHTR1515BRKB	14.4	49200	10.8	36900	208/240/1/60	2	3	2	51.9	60	Yes
BAYHTR1516BRKA	14.4	49200	10.8	36900	208/240/1/60	2	3	2	51.9	60	Yes
BAYHTR1517BRKA	14.4	49200	10.8	36900	208/240/1/60	2	3	2	51.9	60	Yes
BAYHTR1519BRKB	19.2	65500	14.4	49200	208/240/1/60	2	4	2	69.2	80	Yes
BAYHTR1520BRKB	19.2	65500	14.4	49200	208/240/1/60	2	4	2	69.2	80	Yes
BAYHTR1521BRKB	19.2	65500	14.4	49200	208/240/1/60	2	4	2	69.2	80	Yes
BAYHTR1522BRKA	19.2	65500	14.4	49200	208/240/1/60	2	4	2	69.2	80	Yes
BAYHTR1523BRKA	19.2	65500	14.4	49200	208/240/1/60	2	4	2	69.2	80	Yes
BAYHTR1525BRKA	24.0	81900	18.0	61600	208/240/1/60	2	4	2	86.4	100	Yes

**Table AH-13-B — BAYHTR35 — Heater, 3-Phase, for TEM Air Handlers <sup>①</sup>**

Heater Model Number	Capacity @ 240 Volts		Capacity @ 208 Volts		Rated Voltage	Control Stages	Number of Heater Racks	Number of Circuits	Heater Amps per Circuit		Contains Circuit Breakers
	kW	BTUH	kW	BTUH					208 Volts	240Volt	
BAYHTR3510LUGC	9.60	32800	7.20	24600	208/240/3/60	1	3	1	20.0	23.1	No
BAYHTR3515LUGC	14.4	49200	10.8	36900	208/240/3/60	1	3	1	30.0	34.6	No
BAYHTR3517LUGA	14.4	49200	10.8	36900	208/240/3/60	1	3	1	30.0	34.6	No

BRK = Contains circuit breakers

LUG = Lug connections

① 3-Phase - W1 and W2 must be jumpered at low voltage connector

# Heater Matches for TEM Split System Air Handlers with metal blower housing

**Table AH-14-A — TEM8 and TEM6 Air Handler and Heater matches**

TEM6/TEM8 HEATER MATRIX									
AIR HANDLER	HEATER MODEL NUMBER								
MODEL NUMBER	BAYHTR1504BRKC BAYHTR1504LUGB 3.84 Kw	BAYHTR1505BRKC BAYHTR1505LUGB 4.80 Kw	BAYHTR1508BRKC BAYHTR1508LUGB 7.68 Kw	BAYHTR1510BRKC BAYHTR1510LUGB 9.60 Kw	BAYHTR1517BRKA 14.40 Kw	BAYHTR1523BRKA 19.20 Kw	BAYHTR1525BRKA 24.00 Kw	BAYHTR3510LUGC 9.60 Kw	BAYHTR3517LUGA 14.40 Kw
TEM8A0B24V21DB TEM8A0B30V31DB TEM6A0B24H21SB TEM6A0B30H21SB	Y	Y	Y	Y	Y	-	-	Y	Y
TEM8A0C36V31DB TEM8A0C42V41DB TEM6A0C36H31SB TEM6A0C42H41SB	Y	Y	Y	Y	Y	Y	-	Y	Y
TEM8A0C48V41DB TEM8A0C60V51DB TEM6A0C48H41SB TEM6A0C60H51SB	Y	Y	Y	Y	Y	Y	Y	Y	Y
TEM8A0D48V41DB TEM8A0D60V51DB TEM6A0D48H41SB TEM6A0D60H51SB	Y	Y	Y	PHASING ONLY	Y	Y	Y	Y	Y

**Table AH-14-B — TEM4 Air Handler and Heater matches**

TEM4 HEATER MATRIX					
AIR HANDLER	HEATER MODEL NUMBER				
MODEL NUMBER	BAYHTR1504BRKC BAYHTR1504LUGB 3.84 Kw BK BAYHTR1505BRKC BAYHTR1505LUGB 4.80 Kw BK	BAYHTR1508BRKC BAYHTR1508LUGB 7.68 Kw BK BAYHTR1510BRKC BAYHTR1510LUGB BAYHTR3510LUGC 9.60 Kw BK	BAYHTR1517BRKA BAYHTR3517LUGA 14.40 Kw BK	BAYHTR1523BRKA 19.20 Kw BK	BAYHTR1525BRKA 24.00 Kw BK
TEM4A0B18S21SB TEM4A0B24S21SB	Y	Y	--	--	--
TEM4A0B30S31SB TEM4A0B36S31SB	Y	Y	Y	--	--
TEM4A0C37S31SB TEM4A0C42S41SB	Y	Y	Y	Y	--
TEM4A0C48S41SB TEM4A0C60S51SB	Y	Y	Y	Y	Y
TEM4A0B19M21SAA TEM4A0B31M31SAA	Y	Y	--	--	--
TEM4A0C43M41SAA TEM4A0C49M41SAA	Y	Y	Y	Y	Y
TEM4A0C61M51SA	Y	Y	Y	Y	Y

Air Handlers/Heaters

For complete equipment / combination selections, installation instructions and warranty information, please refer to Product Data/Ratings and/or Installers Guides and Limited Warranty Handbooks.

# TMM Wall, Stud, or Over the Water Heater Mount Air Handlers Single Phase

## 1½-3 Tons

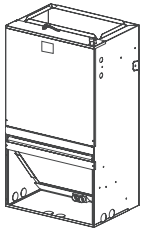

**Table AH-15-A — TMM5 R-410A Wall, Stud, or Over the Water Heater Mount Air Handler 208-230/1/60, ECM Motor, Factory installed R-410A TXV, all aluminum coil, Cooling & Limited Heating**

Unit Model No.	Cooling Capacity (Btuh)	Dimensions (in.) H x W x D	Shipping Weight (lbs.)	Supply Opening	Filter Sizes	Line Size	
						Gas	Liquid
TMM5B0A24M21SA	24000	36.5 x 20.5 x 15.0	93	15 x 9.5	①	¾	⅜
TMM5B0B30M21SA	30000	39.5 x 22.0 x 19.0	115	19 x 9.5	①	¾	⅜
TMM5B0B36M31SA	36000	39.5 x 22.0 x 19.0	115	19 x 9.5	①	¾	⅜

**Table AH-15-B — TMM4 R-410A Wall, Stud, or Over the Water Heater Mount Air Handler 208-230/1/60, PSC Motor, Factory installed R-410A orifice, all aluminum coil, Cooling & Heating**

Unit Model No.	Cooling Capacity (Btuh)	Dimensions (in.) H x W x D	Shipping Weight (lbs.)	Supply Opening	Filter Sizes	Line Size	
						Gas	Liquid
TMM4B0A18S21SA	18000	36.5 x 20.5 x 15.0	97	15 x 9.5	①	¾	⅜
TMM4B0A24S21SA	24000	36.5 x 20.5 x 15.0	97	15 x 9.5	①	¾	⅜
TMM4B0B30S21SA	30000	39.5 x 22.0 x 19.0	119	19 x 9.5	①	¾	⅜
TMM4B0B36S31SA	36000	39.5 x 22.0 x 19.0	119	19 x 9.5	①	¾	⅜

① Filter not supplied. Remote filter required.

**Table AH-15-C — Features**

	TMM5B 2-3	TMM4B 1-1/2-3
• Painted metal cabinet with captured foil face insulation .....	✓	✓
• 2% or less air leakage .....	✓	✓
• All aluminum coil .....	✓	✓
• Direct drive, multi speed ECM blower motor - Constant torque ECM (electronically commutated motor) with fan-off time delay programming .....	✓	—
• PSC Motor .....	—	✓
• Limited HP matched system ratings .....	—	✓
• R-4.2 Insulating Value .....	✓	✓
• Upflow only .....	✓	✓
• Front return option .....	✓	✓
• High Efficiency Copper / Aluminum Coil .....	✓	✓
• Electric Heaters with polarized plug connections (sold as accessory) .....	✓	✓
• R-410A Thermal Expansion Valve .....	✓	—
• Low Voltage Pigtail Connections .....	✓	✓
• Single Color .....	✓	✓
• Fused 24V Power .....	✓	✓
• Wipeable interior design .....	✓	✓
• Maximum Height 39.5" .....	✓	✓
• Maximum Width 22" .....	✓	✓
• Compact 22" depth .....	✓	✓
• Optional R-22 and R-410A TXV kits (sold as accessory) .....	✓	✓
• <b>10-year limited warranty/parts with registration*</b> .....	✓	✓
• <b>10-year limited warranty/coil with registration*</b> .....	✓	✓

\* Registered Limited Warranty terms are available when you register within 60 days of installation. You can register online at americanstandardair.com or by phone at 855-260-2975, otherwise American Standard Heating & Air Conditioning's Base Limited Warranty terms will apply. Base Limited Warranty information on specific products can be found on ASDealerNet.com.

# TMM Wall, Stud, or Over the Water Heater Mount Air Handlers Single Phase 1½-3 Tons

**Table AH-16-A — Optional Accessories**

Model Number	Description	TMM5B	TMM4B
4AYTXVH3G2436A	R-410A TXV kit 1-1/2 to 3 ton	—	✓
2AYTXVH3G2436A	R-22 TXV conversion kit 1-1/2 to 3 ton	✓	✓
BAYFRTLLOUPNL20	Front louver panel 20.5" width	—	✓
BAYFRTLLOUPNL22	Front louver panel 22.0" width	✓	✓
BAYTMMWALLPNL1	Return air / service wall panel (Qty 20)	✓	✓

## Heaters for TMM Split System Air Handlers

**Table AH-16-B — BAYHTRM — Heater, Standard, for TMM Air Handlers**

Heater Model Number	Capacity @ 240 Volts		Capacity @ 208 Volts		Rated Voltage	Control Stages	Number of Heater Racks	Number of Circuits	Heater Amps per Circuit		Contains Circuit Breakers
	kW	BTUH	kW	BTUH					208 Volts	240 Volt	
BAYHTRM505BRK	5.0	17100	3.8	12800	208/240/1/60	1	1	1	18	20.8	Yes
BAYHTRM508BRK	7.5	25600	5.6	19200	208/240/1/60	1	1	1	27.1	31.2	Yes
BAYHTRM510BRK	10.0	34100	7.5	25600	208/240/1/60	1	2	1	36.1	41.7	Yes

# P-Series Modular Blower - Variable Speed



**Table AH-17-A — P-Series Modular Blower - Variable Speed**

Model Number	Nominal Airflow (Tons)	Blower Motor	Uncrated Dimensions (in.)			Shipping Weight (lbs.)	Max. Fuse	Filter** Sizes
			H	W	D			
POV0A000M30SBA	3	VS①	34	14 <sup>1/2</sup>	28 <sup>3/4</sup>	83	15	14 x 25 x 1
POV0B000M40SBA	4	VS①	34	17 <sup>1/2</sup>	28 <sup>3/4</sup>	92	15	16 x 25 x 1
POV0C000M50SBA	5	VS①	34	21	28 <sup>3/4</sup>	101	15	20 x 25 x 1
POV0D000M50SBA	5	VS①	34	24 <sup>1/2</sup>	28 <sup>3/4</sup>	107	15	24 x 25 x 1

**Table AH-17-B — Features**

	POV0
• 34 Inch Cabinet Height.....	✓
• High efficiency, variable speed blower motor.....	✓
• <b>Vortica™ II</b> blower housing design.....	✓
• Fully insulated cabinet ②.....	✓
• 4-way multi-poise.....	✓
• Painted cabinet with two tone color.....	✓
• Cabinet is certified to less than 1% leakage.....	✓
• Matches industry standard furnace widths (14.5", 17.5", 21", 24.5").....	✓
• 120V wiring connections.....	✓
• Entirely electric operation.....	✓
• Service diagnostic capabilities.....	✓
• Dry contact humidifier/EAC terminals.....	✓
• <b>10-year limited warranty on all functional parts with registration*</b> .....	✓

① Variable Speed

② 14.5" models do not have blower compartment insulation

\* Registered Limited Warranty terms are available when you register within 60 days of installation. You can register online at [americanstandardair.com](http://americanstandardair.com) or by phone at 855-260-2975, otherwise American Standard Heating & Air Conditioning's Base Limited Warranty terms will apply. Base Limited Warranty information on specific products can be found on ASDealerNet.com.

\*\* Filters are not shipped with modular blower.



# Split System – Cased Heat Pump and Cooling Coils



**4TXC  
Comfort™ Coil**

**Table COIL-1-A — Aluminum High Efficiency Staged System Cased Convertible Coils (Upflow/ Downflow/ Horizontal Left or Right) R-410A Refrigerant**

Model Number	Cooling Capacity Range (Tons)	Coil Type	Refrigerant Control	Outlet Dim. (in.) W/H x D	Overall Dim. (in.) H x W x D	Shipping Weight (lbs.)	Line Size	
							OD Gas	OD Liq.
4TXCA002DS3HCA	1.5 - 2.5	A	TXVNB①	12 <sup>3</sup> / <sub>4</sub> x 19 <sup>3</sup> / <sub>8</sub>	17.5 x 14.5 x 21.5	42	3/4	3/8
4TXCA032DS3HCA	1.5 - 3.0	A	TXVNB①	12 <sup>3</sup> / <sub>4</sub> x 19 <sup>3</sup> / <sub>8</sub>	22.5 x 14.5 x 21.5	46	3/4	3/8
4TXCB003DS3HCA	1.5 - 4.0	A	TXVNB①	15 <sup>3</sup> / <sub>4</sub> x 19 <sup>3</sup> / <sub>8</sub>	17.5 x 17.5 x 21.5	50	3/4	3/8
4TXCB004DS3HCB	1.5 - 4.0	A	TXVNB①	15 <sup>3</sup> / <sub>4</sub> x 19 <sup>3</sup> / <sub>8</sub>	22.5 x 17.5 x 21.5	58	7/8	3/8
4TXCC005DS3HCA	1.5 - 4.0	A	TXVNB①	19 <sup>1</sup> / <sub>4</sub> x 19 <sup>3</sup> / <sub>8</sub>	22.5 x 21 x 21.5	60	7/8	3/8
4TXCB006DS3HCA	2.0 - 4.0	A	TXVNB①	15 <sup>3</sup> / <sub>4</sub> x 19 <sup>3</sup> / <sub>8</sub>	26.9 x 17.5 x 21.5	65	7/8	3/8
4TXCC007DS3HCA	2.0 - 5.0	A	TXVNB①	19 <sup>1</sup> / <sub>4</sub> x 19 <sup>3</sup> / <sub>8</sub>	26.9 x 21 x 21.5	69	7/8	3/8
4TXCD008DS3HCA	2.0 - 5.0	A	TXVNB①	22 <sup>3</sup> / <sub>4</sub> x 19 <sup>3</sup> / <sub>8</sub>	26.9 x 24.5 x 21.5	72	7/8	3/8
4TXCC009DS3HCA	3.0 - 5.0	A	TXVNB①	19 <sup>1</sup> / <sub>4</sub> x 19 <sup>3</sup> / <sub>8</sub>	30.7 x 21 x 21.5	78	7/8	3/8
4TXCD010DS3HCA	3.0 - 5.0	A	TXVNB①	22 <sup>3</sup> / <sub>4</sub> x 19 <sup>3</sup> / <sub>8</sub>	30.7 x 24.5 x 21.5	81	7/8	3/8



**4PXC-U  
Comfort™ Coil**

**Table COIL-1-B — Aluminum High Efficiency Staged System Cased Upflow/Downflow Coils R-410A Refrigerant, Convertible to Horizontal Left or Horizontal Right with kit**

Model Number	Cooling Capacity Range (Tons)	Coil Type	Refrigerant Control	Outlet Dim. (in.) W/H x D	Overall Dim. (in.) H x W x D	Shipping Weight (lbs.)	Line Size	
							OD Gas	OD Liq.
4PXCAU24BS3HAA	1.5 - 2.5	A	TXVNB①	12 <sup>3</sup> / <sub>4</sub> x 19 <sup>3</sup> / <sub>8</sub>	17.5 x 14.5 x 21.5	39	3/4	3/8
4PXCBU24BS3HAA	1.5 - 2.5	A	TXVNB①	15 <sup>3</sup> / <sub>4</sub> x 19 <sup>3</sup> / <sub>8</sub>	17.5 x 17.5 x 21.5	42	3/4	3/8
4PXCAU32BS3HAA	1.5 - 3.0	A	TXVNB①	12 <sup>3</sup> / <sub>4</sub> x 19 <sup>3</sup> / <sub>8</sub>	22.5 x 14.5 x 21.5	43	3/4	3/8
4PXCBU30BS3HAA	1.5 - 4.0	A	TXVNB①	15 <sup>3</sup> / <sub>4</sub> x 19 <sup>3</sup> / <sub>8</sub>	17.5 x 17.5 x 21.5	47	3/4	3/8
4PXCCU30BS3HAA	1.5 - 4.0	A	TXVNB①	19 <sup>1</sup> / <sub>4</sub> x 19 <sup>3</sup> / <sub>8</sub>	17.5 x 21 x 21.5	49	3/4	3/8
4PXCBU36BS3HAB	1.5 - 4.0	A	TXVNB①	15 <sup>3</sup> / <sub>4</sub> x 19 <sup>3</sup> / <sub>8</sub>	22.5 x 17.5 x 21.5	54	7/8	3/8
4PXCCU36BS3HAA	1.5 - 4.0	A	TXVNB①	19 <sup>1</sup> / <sub>4</sub> x 19 <sup>3</sup> / <sub>8</sub>	22.5 x 21 x 21.5	56	7/8	3/8
4PXCBU42BS3HAA	1.5 - 4.0	A	TXVNB①	15 <sup>3</sup> / <sub>4</sub> x 19 <sup>3</sup> / <sub>8</sub>	26.9 x 17.5 x 21.5	61	7/8	3/8
4PXCCU42BS3HAA	1.5 - 4.0	A	TXVNB①	19 <sup>1</sup> / <sub>4</sub> x 19 <sup>3</sup> / <sub>8</sub>	26.9 x 21 x 21.5	64	7/8	3/8
4PXCBU48BS3HAA	2.0 - 4.0	A	TXVNB①	15 <sup>3</sup> / <sub>4</sub> x 19 <sup>3</sup> / <sub>8</sub>	26.9 x 17.5 x 21.5	61	7/8	3/8
4PXCCU48BS3HAA	2.0 - 5.0	A	TXVNB①	19 <sup>1</sup> / <sub>4</sub> x 19 <sup>3</sup> / <sub>8</sub>	26.9 x 21 x 21.5	64	7/8	3/8
4PXC48BS3HAA	2.0 - 5.0	A	TXVNB①	22 <sup>3</sup> / <sub>4</sub> x 19 <sup>3</sup> / <sub>8</sub>	26.9 x 24.5 x 21.5	68	7/8	3/8
4PXCCU60BS3HAA	3.0 - 5.0	A	TXVNB①	19 <sup>1</sup> / <sub>4</sub> x 19 <sup>3</sup> / <sub>8</sub>	30.7 x 21 x 21.5	73	7/8	3/8
4PXC48BS3HAA	3.0 - 5.0	A	TXVNB①	22 <sup>3</sup> / <sub>4</sub> x 19 <sup>3</sup> / <sub>8</sub>	30.7 x 24.5 x 21.5	77	7/8	3/8



**4PXC-D  
Comfort™ Coil**

**Table COIL-1-C — Aluminum High Efficiency Staged System Cased Downflow Coils R-410A Refrigerant, Convertible to Horizontal Right with kit**

Model Number	Cooling Capacity Range (Tons)	Coil Type	Refrigerant Control	Outlet Dim. (in.) W/H x D	Overall Dim. (in.) H x W x D	Shipping Weight (lbs.)	Line Size	
							OD Gas	OD Liq.
4PXCBD30BS3HDA	1.5 - 4.0	A	TXVNB①	15 <sup>3</sup> / <sub>4</sub> x 19 <sup>3</sup> / <sub>8</sub>	17.5 x 17.5 x 21.5	47	3/4	3/8
4PXCBD36BS3HDA	1.5 - 4.0	A	TXVNB①	15 <sup>3</sup> / <sub>4</sub> x 19 <sup>3</sup> / <sub>8</sub>	22.5 x 17.5 x 21.5	54	7/8	3/8
4PXCCD36BS3HDA	1.5 - 4.0	A	TXVNB①	19 <sup>1</sup> / <sub>4</sub> x 19 <sup>3</sup> / <sub>8</sub>	22.5 x 21 x 21.5	56	7/8	3/8
4PXCBD42BS3HDA	1.5 - 4.0	A	TXVNB①	15 <sup>3</sup> / <sub>4</sub> x 19 <sup>3</sup> / <sub>8</sub>	26.9 x 17.5 x 21.5	61	7/8	3/8
4PXCCD42BS3HDA	1.5 - 4.0	A	TXVNB①	19 <sup>1</sup> / <sub>4</sub> x 19 <sup>3</sup> / <sub>8</sub>	26.9 x 21 x 21.5	64	7/8	3/8
4PXCCD60BS3HDA	3.0 - 5.0	A	TXVNB①	19 <sup>1</sup> / <sub>4</sub> x 19 <sup>3</sup> / <sub>8</sub>	30.7 x 21 x 21.5	73	7/8	3/8
4PXCDD60BS3HDA	3.0 - 5.0	A	TXVNB①	22 <sup>3</sup> / <sub>4</sub> x 19 <sup>3</sup> / <sub>8</sub>	30.7 x 24.5 x 21.5	77	7/8	3/8

① Start Kit may be required on outdoor unit.

# Split System – Uncased Heat Pump and Cooling Coils

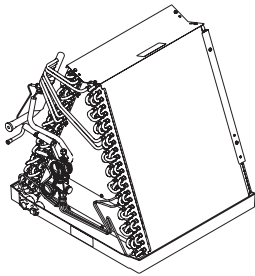

**4PXA Comfort™ Coil**

**Table COIL-2-A — Aluminum Uncased Upflow Coils R-410A Refrigerant**

Model Number	Cooling Capacity Range (Tons)	Coil Type	Refrigerant Control	Overall Dim. (in.) H x W x D	Shipping Weight (lbs.)	Line Size	
						OD Gas	OD Liq.
4PXAAU24BS3HAA	1.5 - 2.5	A	TXVNB①	14.7 x 13.3 x 21.1	24	3/4	3/8
4PXABU24BS3HAA	1.5 - 2.5	A	TXVNB①	14.5 x 16.3 x 21.1	24	3/4	3/8
4PXABU30BS3HAA	1.5 - 4.0	A	TXVNB①	15.8 x 16.3 x 21.1	32	3/4	3/8
4PXACU30BS3HAA	1.5 - 4.0	A	TXVNB①	15.8 x 19.8 x 21.1	32	3/4	3/8
4PXABU36BS3HAA	1.5 - 4.0	A	TXVNB①	21.2 x 16.3 x 21.1	33	7/8	3/8
4PXACU36BS3HAA	1.5 - 4.0	A	TXVNB①	20.8 x 19.8 x 21.1	32	7/8	3/8
4PXABU42BS3HAA	1.5 - 4.0	A	TXVNB①	23.8 x 16.3 x 21.1	33	7/8	3/8
4PXACU42BS3HAA	1.5 - 4.0	A	TXVNB①	23.7 x 19.8 x 21.1	38	7/8	3/8
4PXABU48BS3HAA	2.0 - 4.0	A	TXVNB①	25.3 x 16.3 x 21.1	36	7/8	3/8
4PXACU48BS3HAA	2.0 - 5.0	A	TXVNB①	24.9 x 19.8 x 21.1	38	7/8	3/8
4PXADU48BS3HAA	2.0 - 5.0	A	TXVNB①	24.5 x 23.3 x 21.1	39	7/8	3/8
4PXACU60BS3HAA	3.0 - 5.0	A	TXVNB①	29.2 x 19.8 x 21.1	44	7/8	3/8
4PXADU60BS3HAA	3.0 - 5.0	A	TXVNB①	28.5 x 23.3 x 21.1	45	7/8	3/8

① Start Kit may be required on outdoor unit.

**Table COIL-2-B — 13 SEER Split System - Uncased Coil Enclosures**

Model Number	Coils	Use With Furnaces Flush on Both Sides	Dimensions (in.) H x W x D	Shipping Weight (lbs.)
BAYCLE14A1422A	4PXAAU24BS	14½" Wide Furnace	22½ x 14½ x 21½	12
BAYCLE17A1722A	4PXABU24BS, 4PXABU36BS	17½" Wide Furnace	22⅝ x 17½ x 21½	14
BAYCLE21A2130A	4PXACU30BS, 4PXACU36BS, 4PXACU42BS, 4PXACU48BS	21" Wide Furnace	30 x 21 x 21½	18
BAYCLE24A2430A	4PXADU48BS, 4PXADU60BS	24½" Wide Furnace	30 x 24½ x 21½	22

**Table COIL-2-C - Kits for 4PXC and 4TXC Coils**

Horizontal Conversion Kit No.	Use with Coil Model Numbers
BAYCONV18B	4PXC**24-30
BAYCONV23B	4PXC**32-36
BAYCONV27B	4PXC**42-48
BAYCONV30B	4PXC**60
Optional Downflow Gasket Kit No.	Use with Coil Model Numbers
BAYGSKT001A0	4TXC, 4PXC

**Table COIL-2-D - Air Conditioning and Heat Pump Systems**

ADJUSTABLE R410A TXV KIT	4PXC-U & 4PXA:	4PXC-D	4TXC:
4AYTXVH4A1830A	24	24-30	A002
4AYTXVH4A3042A	30-42	36-42	A032, B003-C005
4AYTXVH4A4860A	48-60	48-60	B006-D010

These R-410A adjustable TXV kits are intended for use with 4TXC, 4PXC, and 4PXA coil families. In addition, these adjustable TXV kits may also be used to lower the superheat on 4TXC, 4PXC, and 4PXA coils to improve the latent capacity in high humidity environments.

**Table COIL-2-E - R-22 TXV Conversion TXV Kits for 4PXC, 4PXA, 4TXC and 4PXF Coils**

R-22 TXV Kit	Use with Coil Model Numbers		
2AYTXVH3H1836A	4PX**24-36	4TXC*002-005	4PXFH001, 003, 005
2AYTXVH3H4248A	4PX**42-48	4TXC*006-008	4PXFH004
2AYTXVH3H6060A	4PX**60	4TXC*009-010	4PXFH007, 009

# Split System – Cased Heat Pump and Cooling Coils

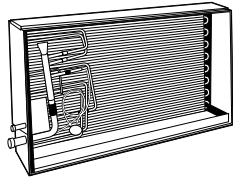

4PXF

**Table COIL-3-A — Copper/Aluminum Cased Horizontal Flat Coils R-410A Refrigerant**

Model Number	Cooling Capacity Range (Tons)	Coil Type	Refrigerant Control	Outlet Dim. (in.) W/H x D	Overall Dim. (in.) H x W x D	Shipping Weight (lbs.)	Line Size OD Gas	Line Size OD Liq.
4PXFH001AC3HHA	1.5 - 3.0	Flat	TXVNB①	21 x 24	23.5 x 10 x 29.5	43	3/4	3/8
4PXFH004AC3HHA	2.0 - 3.5	Flat	TXVNB①	21 x 30	23.5 x 10 x 35.5	49	3/4	3/8
4PXFH007AC3HHA	3.0 - 5.0	Flat	TXVNB①	21 x 30	23.5 x 10 x 35.5	63	7/8	3/8
Variable Speed OD compatible models								
4PXFH003AZ3HHA	1.5 - 2.0	Flat	TXVNB①	21 x 30	23.5 x 10 x 35.5	49	3/4	3/8
4PXFH005AZ3HHA	2.0 - 3.5	Flat	TXVNB①	21 x 30	23.5 x 10 x 35.5	63	7/8	3/8
4PXFH009AZ3HHA	3.0 - 5.0	Flat	TXVNB①	21 x 36	23.5 x 10 x 41.5	70	7/8	3/8

① Start Kit may be required on outdoor unit.

**Table COIL-3-B — All Aluminum Cased Horizontal Flat Coils R-410A Refrigerant**

Model Number	Cooling Capacity Range (Tons)	Coil Type	Refrigerant Control	Outlet Dim. (in.) W/H x D	Overall Dim. (in.) H x W x D	Shipping Weight (lbs.)	Line Size OD Gas	Line Size OD Liq.
4PXFH001BC3HHA	1.5 - 3.0	Flat	TXVNB①	21 X 24	23.5 x 10 x 29.5	40	3/4	3/8
4PXFH004BC3HHA	2.0 - 3.5	Flat	TXVNB①	21 X 30	23.5 x 10 x 35.5	47	3/4	3/8
4PXFH007BC3HHA	3.0 - 5.0	Flat	TXVNB①	21 X 30	23.5 x 10 x 35.5	61	7/8	3/8
Variable Speed OD compatible models								
4PXFH003BZ3HHA	1.5 - 2.0	Flat	TXVNB①	21 X 30	23.5 x 10 x 35.5	47	3/4	3/8
4PXFH005BZ3HHA	2.0 - 3.5	Flat	TXVNB①	21 X 30	23.5 x 10 x 35.5	61	7/8	3/8
4PXFH009BZ3HHA	3.0 - 5.0	Flat	TXVNB①	27 X 34	29.5 X 10 X 41.5	71	7/8	3/8

① Start Kit may be required on outdoor unit.

# Split System – Cased Heat Pump and Cooling Coils

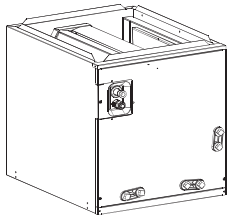

4MXC

**Table COIL-4-A — Aluminum Single Stage Cased Coil (Upflow/Downflow/Horizontal) R-410A Refrigerant**

Model Number	Cooling Capacity Range (Tons)	Coil Type	Refrigerant Control	Outlet Dim. (in.) W/H x D	OverallDim. (in.) H x W x D	Shipping Weight (lbs.)	Line Size OD Gas	Line Size OD Liq.
4MXCA003AC6HCA	1.5 - 3.0	A	FCCV <sup>①</sup>	13 x 19	20 x 14.5 x 21	51	3/4	3/8
4MXCB004AC6HCA	1.5 - 3.0	A	FCCV <sup>①</sup>	16 x 19	20 x 17.5 x 21	55	3/4	3/8
4MXCC005AC6HCA	2.5 - 3.0	A	FCCV <sup>①</sup>	19 1/2 x 19	20 x 21 x 21	59	3/4	3/8
4MXCB006AC6HCA	3.0 - 4.0	A	FCCV <sup>①</sup>	16 x 19	26 x 17.5 x 21	66	7/8	3/8
4MXCC007AC6HCA	3.0 - 4.0	A	FCCV <sup>①</sup>	19 1/2 x 19	26 x 21 x 21	70	7/8	3/8
4MXCD008AC6HCA	3.5 - 4.0	A	FCCV <sup>①</sup>	23 x 19	26 x 24.5 x 21	74	7/8	3/8
4MXCC009AC6HCA	3.5 - 5.0	A	FCCV <sup>①</sup>	19 1/2 x 19	30 x 21 x 21	91	7/8	3/8
4MXCD010AC6HCA	3.5 - 5.0	A	FCCV <sup>①</sup>	23 x 19	30 x 24.5 x 21	95	7/8	3/8
4MXCB016AC6HCA <sup>②</sup>	3.0 - 4.0	A	FCCV <sup>①</sup>	16 x 19	30 x 17.5 x 21	82	7/8	3/8
4MXCC017AC6HCA <sup>②</sup>	3.0 - 4.0	A	FCCV <sup>①</sup>	19 1/2 x 19	30 x 21 x 21	88	7/8	3/8
4MXCD018AC6HCA <sup>②</sup>	3.5 - 4.0	A	FCCV <sup>①</sup>	23 x 19	30 x 24.5 x 21	92	7/8	3/8

① All coils shipped with a Fixed Metering Device (Flow Control Check Valve - FCCV). Some rated combinations require a TXV kit, ordered separately. See the coil Installer's Guide for Orifice and TXV matches.

② Enhanced models for use in heating.

**Table COIL-4-B — Aluminum Single Stage Cased Coil (Upflow/Downflow/Horizontal) R-410A Refrigerant**

Model Number	Cooling Capacity Range (Tons)	Coil Type	Refrigerant Control	Outlet Dim. (in.) W/H x D	OverallDim. (in.) H x W x D	Shipping Weight (lbs.)	Line Size OD Gas	Line Size OD Liq.
4MXCA003AC6HCB	1.5 - 3.0	A	FCCV <sup>②</sup>	13 x 19	20 x 14.5 x 21	51	3/4	3/8
4MXCB004AC6HCB	1.5 - 3.0	A	FCCV <sup>②</sup>	16 x 19	20 x 17.5 x 21	55	3/4	3/8
4MXCC005AC6HCB	2.5 - 3.0	A	FCCV <sup>②</sup>	19 1/2 x 19	20 x 21 x 21	59	3/4	3/8
4MXCB006AC6HCB	3.0 - 4.0	A	FCCV <sup>②</sup>	16 x 19	26 x 17.5 x 21	66	7/8	3/8
4MXCC007AC6HCB	3.0 - 4.0	A	FCCV <sup>②</sup>	19 1/2 x 19	26 x 21 x 21	70	7/8	3/8
4MXCD008AC6HCB	3.5 - 4.0	A	FCCV <sup>②</sup>	23 x 19	26 x 24.5 x 21	74	7/8	3/8
4MXCC009AC6HCB	3.5 - 5.0	A	FCCV <sup>②</sup>	19 1/2 x 19	30 x 21 x 21	91	7/8	3/8
4MXCD010AC6HCB	3.5 - 5.0	A	FCCV <sup>②</sup>	23 x 19	30 x 24.5 x 21	95	7/8	3/8
4MXCB016AC6HCB <sup>①</sup>	3.0 - 4.0	A	FCCV <sup>②</sup>	16 x 19	30 x 17.5 x 21	82	7/8	3/8
4MXCC017AC6HCB <sup>①</sup>	3.0 - 4.0	A	FCCV <sup>②</sup>	19 1/2 x 19	30 x 21 x 21	88	7/8	3/8
4MXCD018AC6HCB <sup>①</sup>	3.5 - 4.0	A	FCCV <sup>②</sup>	23 x 19	30 x 24.5 x 21	92	7/8	3/8

① Enhanced models for use in heating.

② All coils shipped with a Fixed Metering Device (Flow Control Check Valve - FCCV). Some rated combinations require a TXV kit, ordered separately. See the coil Installer's Guide for Orifice and TXV matches.

Unpainted cabinet model ending in "B" to launch in Q2 2022

# Split System – Cased Heat Pump and Cooling Coils

**Table COIL-5-A — Refrigerant TXV Kits**

Tons	R-410A TXV Kit (If required)	R-22 TXV Kit (If required)
1.5 - 3.0	4AYTXVH3G2436A	2AYTXVH2G2436A
3.5 - 4.0	4AYTXVH3G4248B	2AYTXVH3G4248B
5	4AYTXVH3G6000B	2AYTXVH3G6000B

Note: Additional R-22 Kit combinations can be found in the Accessories section.

**Table COIL-5-B — Orifice kit table for 4MXC coils**

Outdoor Unit Capacity (Tons)	Orifice Size (R410A)	Orifice Kit	Orifice Size (R22)	Orifice Kit
1.5	0.052	MAYORIACHP0052B	0.052	MAYORIACHP0052B
2	0.058	MAYORIACHP0058B	0.058	MAYORIACHP0058B
2.5*	0.063 / 0.065	MAYORIACHP0063B / 065A	0.065	MAYORIACHP0065A
3	0.070	MAYORIACHP0070B	0.072	MAYORIACHP0072B
3.5	0.075	MAYORIACHP0075B	0.078	MAYORIACHP0078B
4	0.083	MAYORIACHP0083B	0.088	MAYORIACHP0088B
5	0.090	MAYORIACHP0090B	0.096	MAYORIACHP0096B

Note: Orifice size needed for system combination may not be pre-installed. See Table 1 in coil Installation Manual for pre-installed size.

\* Necessary Orifice sizes varies for this tonnage. See Table 3 in coil Installation Manual.

# Split System – Cased/Uncased Heat Pump and Cooling Coils

**Table COIL-5-C — Features**

	4TXC	4PXC-U	4PXC-D	4PXA	4PXF	4MXC
• All aluminum coil .....	✓	✓	✓	✓	✓ <sup>④</sup>	✓
• Enhanced Fin Surface .....	✓	✓	✓	✓	—	—
• 100% foil lined insulation.....	✓	✓	✓	—	✓	✓
• Internally checked non-bleed thermal expansion valve with mechanical fitting on both sides (heat pump operation) <sup>①</sup> .....	✓	✓	✓	✓	✓	—
• Factory installed fixed orifice. Additional orifices supplied .....	—	—	—	—	—	✓
• Optional accessory TXV Kit with mechanical fittings available for higher performance ratings <sup>③</sup> .....	—	—	—	—	—	✓
• Easy case attachment to furnace .....	✓	✓	✓	—	—	✓
• Upflow application.....	✓	✓	—	✓	—	✓
• Downflow application .....	✓	✓	✓	—	—	✓
• Horizontal Right application .....	✓	kit	kit	—	✓	✓
• Horizontal Left application.....	✓	kit	—	—	✓	✓
• Double sloped non-corrosive drain pan - UL rated 400°F. Compatible with oil furnaces.....	✓	✓	✓	✓	—	—
• Single sloped non-corrosive drain pan.....	—	—	—	—	✓	✓
• Compatible with variable speed and 2 speed outdoor models .....	✓	✓	✓	✓	②	—
• Split inner and outer doors for easy coil inspection and cleaning.....	✓	✓	✓	—	—	—
• Painted galvanized steel cabinet.....	✓	✓	✓	—	—	A*
• Unpainted galvanized steel cabinet .....	—	—	—	—	✓	B*
• <b>10-year limited warranty on coil, &amp; all other functional parts, with registration<sup>⑤</sup> .....</b>	✓	✓	✓	✓	✓	✓

① Start kit may be required on outdoor unit.

② See Tables COIL-3-A and COIL-3-B for specific models that are compatible with variable speed outdoor products.

③ Reference AHRI ratings to find correct TXV kit or reference Product Data for additional information.

④ 4PXF coils with a "B" as the 9th digit will be all-aluminum design. Those with an "A" in the 9th digit still have copper tubes.

⑤ Registered Limited Warranty terms are available when you register within 60 days of installation. You can register online at americanstandardair.com or by phone at 855-260-2975, otherwise American Standard Heating & Air Conditioning's Base Limited Warranty terms will apply. Base Limited Warranty information on specific products can be found on ASDealerNet.com.

\* 4MXC coils with a "B" as the 14th digit will have an unpainted galvanized steel cabinet. Those with an "A" in the 14th digit will have a painted galvanized steel cabinet.

# S9V2-VS – Two Stage ECM Variable Speed

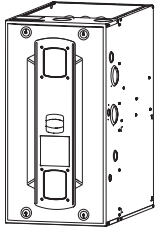

**S9V2-VS  
Direct Vent  
Upflow**

**Table FUR-1-A — S9V2-VS Variable Speed, 2 Stage, Direct/Non-Direct Vent, Upflow/Horizontal Left/Horizontal Right Condensing Gas Furnace with Variable Speed Draft Inducer (120/1/60)③**

Unit Model Number	Airflow In Tons	Output (Btuh)		ICS① AFUE	Flue Size (in)	Ignition Device	Uncrated Dimensions (in.) H x W x D	Shipping Weight (lbs.)	Max Fuse*	Filter Sizes**
		Stage 2	Stage 1							
S9V2B040U3VSAC	3	39,141	25,639	97.0②	2, 3, 4	④	34 x 17 <sup>1</sup> / <sub>2</sub> x 28 <sup>3</sup> / <sub>4</sub>	122	15	16 x 25 x 1
S9V2B060U3VSAC	3	57,838	38,271	97.0②	2, 3, 4	④	34 x 17 <sup>1</sup> / <sub>2</sub> x 28 <sup>3</sup> / <sub>4</sub>	127	15	16 x 25 x 1
S9V2B080U4VSAC	4	78,400	50,960	97.0②	2, 3, 4	④	34 x 17 <sup>1</sup> / <sub>2</sub> x 28 <sup>3</sup> / <sub>4</sub>	135	15	16 x 25 x 1
S9V2C100U4VSAC	4	96,362	64,036	97.0②	2, 3, 4	④	34 x 21 x 28 <sup>3</sup> / <sub>4</sub>	154	15	20 x 25 x 1
S9V2D120U5VSAC	5	113,145	76,668	97.0②	3, 4	④	34 x 24 <sup>1</sup> / <sub>2</sub> x 28 <sup>3</sup> / <sub>4</sub>	167	15	24 x 25 x 1

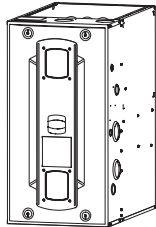

**S9V2-VS  
Direct Vent  
Downflow**

**Table FUR-1-B — S9V2-VS Variable Speed, 2 Stage, Direct/Non-Direct Vent, Downflow Condensing Gas Furnace with Variable Speed Draft Inducer (120/1/60)③**

Unit Model Number	Airflow In Tons	Output (Btuh)		ICS① AFUE	Flue Size (in)	Ignition Device	Uncrated Dimensions (in.) H x W x D	Shipping Weight (lbs.)	Max Fuse*	Filter Sizes**
		Stage 2	Stage 1							
S9V2B080D4VSAC	4	78,400	50,960	97.0②	2, 3, 4	④	34 x 17 <sup>1</sup> / <sub>2</sub> x 28 <sup>3</sup> / <sub>4</sub>	135	15	(2)14 x 20 x 1
S9V2C100D4VSAC	4	95,833	63,950	97.0②	2, 3, 4	④	34 x 21 x 28 <sup>3</sup> / <sub>4</sub>	154	15	(2)16 x 20 x 1

Note: Variable speed furnaces should not be twinned and are not approved for twinning applications.

① Isolated Combustion System. AFUE may vary based on poise.

② Energy Star®.

③ Direct drive variable speed motor is an ECM constant airflow blower motor.

④ Silicon Nitride Igniter.

\* Information subject to change. Please confirm with current Product Data/Service Facts for current factory production.

\*\* Filters are not shipped with furnace. For Upflow furnaces, the size is for a bottom return filter.

# S9V2 – Two Stage ECM Variable Speed

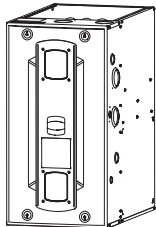

**S9V2  
Direct Vent  
Upflow**

**Table FUR-1-C — S9V2 Variable Speed, 2 Stage, Direct/Non-Direct Vent, Upflow/Horizontal Left/Horizontal Right Condensing Gas Furnace (120/1/60)③**

Unit Model Number	Airflow In Tons	Output (Btuh)		ICS① AFUE	Flue Size (in)	Ignition Device	Uncrated Dimensions (in.) H x W x D	Shipping Weight (lbs.)	Max Fuse*	Filter Sizes**
		Stage 2	Stage 1							
S9V2B040U3PSBC	3	38,800	25,220	96.0②	2, 3, 4	④	34 x 17 <sup>1</sup> / <sub>2</sub> x 28 <sup>3</sup> / <sub>4</sub>	122	15	16 x 25 x 1
S9V2B060U4PSBC	4	58,200	37,830	96.0②	2, 3, 4	④	34 x 17 <sup>1</sup> / <sub>2</sub> x 28 <sup>3</sup> / <sub>4</sub>	130	15	16 x 25 x 1
S9V2B080U4PSBC	4	77,600	50,440	96.0②	2, 3, 4	④	34 x 17 <sup>1</sup> / <sub>2</sub> x 28 <sup>3</sup> / <sub>4</sub>	135	15	16 x 25 x 1
S9V2C080U5PSBC	5	77,600	50,440	96.0②	2, 3, 4	④	34 x 21 x 28 <sup>3</sup> / <sub>4</sub>	149	15	20 x 25 x 1
S9V2C100U5PSBC	5	97,000	63,050	96.0②	2, 3, 4	④	34 x 21 x 28 <sup>3</sup> / <sub>4</sub>	155	15	20 x 25 x 1
S9V2D120U5PSBC	5	116,400	75,660	96.0②	3, 4	④	34 x 24 <sup>1</sup> / <sub>2</sub> x 28 <sup>3</sup> / <sub>4</sub>	167	15	24 x 25 x 1

**Table FUR-1-D — S9V2 Variable Speed, 2 Stage, Direct/Non-Direct Vent, Downflow Condensing Gas Furnace (120/1/60)③**

Unit Model Number	Airflow In Tons	Output (Btuh)		ICS① AFUE	Flue Size (in)	Ignition Device	Uncrated Dimensions (in.) H x W x D	Shipping Weight (lbs.)	Max Fuse*	Filter Sizes**
		Stage 2	Stage 1							
S9V2B040D3PSBC	3	38,800	25,220	96.0②	2, 3, 4	④	34 x 17 <sup>1</sup> / <sub>2</sub> x 28 <sup>3</sup> / <sub>4</sub>	122	15	(2)14 x 20 x 1
S9V2B060D3PSBC	3	58,200	37,830	96.0②	2, 3, 4	④	34 x 17 <sup>1</sup> / <sub>2</sub> x 28 <sup>3</sup> / <sub>4</sub>	127	15	(2)14 x 20 x 1
S9V2B080D4PSBC	4	77,600	50,440	96.0②	2, 3, 4	④	34 x 17 <sup>1</sup> / <sub>2</sub> x 28 <sup>3</sup> / <sub>4</sub>	135	15	(2)14 x 20 x 1
S9V2C100D5PSBC	5	97,000	63,050	96.0②	2, 3, 4	④	34 x 21 x 28 <sup>3</sup> / <sub>4</sub>	155	15	(2)16 x 20 x 1
S9V2D120D5PSBC	5	116,400	75,660	96.0②	3, 4	④	34 x 24 <sup>1</sup> / <sub>2</sub> x 28 <sup>3</sup> / <sub>4</sub>	167	15	(2)16 x 20 x 1

Note: Variable speed furnaces should not be twinned and are not approved for twinning applications.

① Isolated Combustion System. AFUE may vary based on poise.

② Energy Star®.

③ Direct drive variable speed motor is an ECM constant airflow blower motor.

④ Silicon Nitride Igniter.

\* Information subject to change. Please confirm with current Product Data/Service Facts for current factory production.

\*\* Filters are not shipped with furnace. For Upflow furnaces, the size is for a bottom return filter.

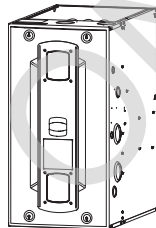

**S9V2  
Direct Vent  
Downflow**

# S9X2 – Two Stage High Efficiency ECM

**Table FUR-2-A — S9X2 High Efficiency 9 Speed ECM Motor, 2 Stage, Direct/Non-Direct Vent, Upflow/Horizontal Left/Horizontal Right Condensing Gas Furnace (120/1/60)<sup>③</sup>**

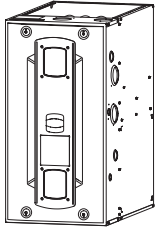

**S9X2  
Direct Vent  
Upflow**

Unit Model Number	Airflow In Tons	Output (Btuh)		ICS <sup>①</sup> AFUE	Flue Size (in)	Ignition Device	Uncrated Dimensions (in.) H x W x D	Shipping Weight (lbs.)	Max Fuse*	Filter Sizes**
		Stage 2	Stage 1							
S9X2B040U3PSBA	3	38,800	25,220	96.0 <sup>②</sup>	2, 3, 4	④	34 x 17 <sup>1</sup> / <sub>2</sub> x 28 <sup>3</sup> / <sub>4</sub>	122	15	16 x 25 x 1
S9X2B060U4PSBA	4	58,200	37,830	96.0 <sup>②</sup>	2, 3, 4	④	34 x 17 <sup>1</sup> / <sub>2</sub> x 28 <sup>3</sup> / <sub>4</sub>	130	15	16 x 25 x 1
S9X2B080U4PSBA	4	77,600	50,440	96.0 <sup>②</sup>	2, 3, 4	④	34 x 17 <sup>1</sup> / <sub>2</sub> x 28 <sup>3</sup> / <sub>4</sub>	135	15	16 x 25 x 1
S9X2C080U5PSBA	5	77,600	50,440	95.0 <sup>②</sup>	2, 3, 4	④	34 x 21 x 28 <sup>3</sup> / <sub>4</sub>	149	15	20 x 25 x 1
S9X2C100U5PSBA	5	97,000	63,050	96.0 <sup>②</sup>	2, 3, 4	④	34 x 21 x 28 <sup>3</sup> / <sub>4</sub>	155	15	20 x 25 x 1
S9X2D120U5PSBA	5	116,400	75,660	96.0 <sup>②</sup>	3, 4	④	34 x 24 <sup>1</sup> / <sub>2</sub> x 28 <sup>3</sup> / <sub>4</sub>	167	15	24 x 25 x 1

**Table FUR-2-B — S9X2 High Efficiency 9 Speed ECM Motor, 2 Stage, Direct/Non-Direct Vent, Downflow Condensing Gas Furnace (120/1/60)<sup>③</sup>**

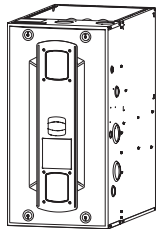

**S9X2  
Direct Vent  
Downflow**

Unit Model Number	Airflow In Tons	Output (Btuh)		ICS <sup>①</sup> AFUE	Flue Size (in)	Ignition Device	Uncrated Dimensions (in.) H x W x D	Shipping Weight (lbs.)	Max Fuse*	Filter Sizes**
		Stage 2	Stage 1							
S9X2B040D3PSBA	3	38,800	25,220	96.0 <sup>②</sup>	2, 3, 4	④	34 x 17 <sup>1</sup> / <sub>2</sub> x 28 <sup>3</sup> / <sub>4</sub>	122	15	(2)14 x 20 x 1
S9X2B060D3PSBA	3	58,200	37,830	95.0 <sup>②</sup>	2, 3, 4	④	34 x 17 <sup>1</sup> / <sub>2</sub> x 28 <sup>3</sup> / <sub>4</sub>	127	15	(2)14 x 20 x 1
S9X2B080D4PSBA	4	77,600	50,440	96.0 <sup>②</sup>	2, 3, 4	④	34 x 17 <sup>1</sup> / <sub>2</sub> x 28 <sup>3</sup> / <sub>4</sub>	135	15	(2)14 x 20 x 1
S9X2C100D5PSBA	5	97,000	63,050	95.0 <sup>②</sup>	2, 3, 4	④	34 x 21 x 28 <sup>3</sup> / <sub>4</sub>	155	15	(2)16 x 20 x 1
S9X2D120D5PSBA	5	116,400	75,660	96.0 <sup>②</sup>	3, 4	④	34 x 24 <sup>1</sup> / <sub>2</sub> x 28 <sup>3</sup> / <sub>4</sub>	167	15	(2)16 x 20 x 1

① Isolated Combustion System. AFUE may vary based on poise.

② Energy Star<sup>®</sup>.

③ Direct drive 9 speed motor is a high efficiency constant torque ECM blower motor.

④ Silicon Nitride Igniter.

\* Information subject to change. Please confirm with current Product Data/Service Facts for current factory production.

\*\* Filters are not shipped with furnace. For Upflow furnaces, the size is for a bottom return filter.

**Table FUR-2-C — High Altitude Pressure Switch S9V2-VS 90% Furnaces**

Model Number	Description	Used With	Shipping Weight
BAYHALT250	2 Switches	S9V2B040U3VSA	2
BAYHALT251	2 Switches	S9V2B060U3VSA	2
BAYHALT252	2 Switches	S9V2B080U4VSA, S9V2B080D4VSA, S9V2C100D4VSA	2
BAYHALT253	2 Switches	S9V2C100U4VSA	2
BAYHALT254	2 Switches	S9V2D120U5VSA	2

# Convertible Gas Furnaces

**Table FUR-3-A — Features**

	S9V2-VS Variable Speed	S9V2 Variable Speed	S9X2 Multi-Speed
• Direct drive, variable speed ECM blower motor - Constant airflow ECM (electronically commutated motor)	✓	✓	—
• Direct drive, multi speed ECM blower motor - Constant torque ECM (electronically commutated motor)	—	—	✓
• Variable speed draft inducer motor	✓	✓	✓
• <b>Comfort-R™</b> enhanced mode (cooling)	✓	✓	—
• Standard 34" height	✓	✓	✓
• 3 Way poise Upflow furnace model (Upflow, Horizontal Left, Horizontal Right)	✓	✓	✓
• Dedicated Downflow furnace model	✓	✓	✓
• Front service access with easily accessible burners, sensors, orifices, switches, and other components	✓	✓	✓
• Cabinet has no knockouts - Rubber and plastic plugs come installed from factory	✓	✓	✓
• Gas can enter either side of cabinet	✓	✓	✓
• Condensate can exit either side of cabinet in Upflow orientation	✓	✓	✓
• Multiple venting options - Every model, every size will offer two venting options	✓	✓	✓
• Integrated Furnace Control board with digital configuration, status, and fault codes	✓	✓	✓
• Alpha-numeric diagnostic codes	✓	✓	✓
• Dry contact Humidifier/EAC hook-up capability	✓	✓	✓
• Adjustable blower off delay for heating and cooling	✓	✓	✓
• Last six fault codes are stored (even with power loss)	✓	✓	✓
• Stainless steel primary and secondary heat exchanger tubes	✓	✓	✓
• Longer IFC wire harnesses allow door to be removed without disconnecting the harness	✓	✓	✓
• Alternate bottom/left/right return air (upflow models only)	✓	✓	✓
• Bottom panel	✓	✓	✓
• Dual PVC pipe venting (1 or 2 pipe option)	✓	✓	✓
• Two stage combination gas valve and regulator	✓	✓	✓
• Gasketed inner and outer door	✓	✓	✓
• Heavy gauge reinforced wrap-around steel cabinet	✓	✓	✓
• Insulated blower compartment	✓	✓	✓
• Left/right condensate drain capability in vertical application	✓	✓	✓
• Service diagnostics with faults reported on IFC board	✓	✓	✓
• Manual reset flame roll out switches	✓	✓	✓
• Mobile home approved with mobile home kit	✓	✓	✓
• Multi-port in shot burners	✓	✓	✓
• Service diagnostic capabilities	✓	✓	✓
• <b>Vortica™ II</b> blower housing	✓	✓	✓
• Slide out blower assembly on full-length rails	✓	✓	✓
• Side return duct starter tabs (upflow models only)	✓	✓	✓
• Silicon Nitride 120V hot surface igniter	✓	✓	✓
• Multiple heating blower speeds	✓	✓	✓
• Meets requirements for 1% or less air leakage	✓	✓	✓
• <b>Limited lifetime heat exchanger warranty &amp; 10-year on all other functional parts with registration (Residential Use)</b>	✓	✓	✓
• <b>Optional extended warranties available</b>	✓	✓	✓

Note: Variable speed furnaces should not be twinned and are not approved for twinning applications.

\* Registered Limited Warranty terms are available when you register within 60 days of installation. You can register online at americanstandardair.com or by phone at 855-260-2975, otherwise American Standard Heating & Air Conditioning's Base Limited Warranty terms will apply. Base Limited Warranty information on specific products can be found on ASDealerNet.com.

**Table FUR-3-B — Optional Accessories**

Model Number	Description	Shipping Weight	S9V2-VS Variable Speed	S9V2 Variable Speed	S9X2 Multi-Speed
AYLPSS400C	LP Kit with Stainless Steel Burners	3	✓	✓	✓
BAYHANG	Horizontal hanging kit	2	✓	✓	✓
BAYVENT200B	Sidewall vent Termination Kit to Direct vent furnaces	2	✓	✓	✓
BAYVENTCN200B	Sidewall vent Termination Kit to Direct vent furnaces for Canadian applications	2	✓	✓	✓
BAYAIR30AVENTA	Concentric vent kit for 2, 2½ and 3" vent system	11	✓	✓	✓
BAYAIR30CNVENT	Concentric vent kit for 2, 2½ and 3" vent system for Canadian applications	11	✓	✓	✓
BAYREDUCE	Reducer Coupling for Canadian applications (CPVC)	1	✓	✓	✓
BAYLIFTB	Dual return kit. B size extension	8	✓	✓	✓
BAYLIFTC	Dual return kit. C size extension	9	✓	✓	✓
BAYLIFTD	Dual return kit. D size extension	9	✓	✓	✓
BAYMFGH200B	Manufactured/mobile home kit	1	✓	✓	✓
BAYCNDTRAP2A	In-line condensate collector for 2" PVC pipe	1	✓	✓	✓
BAYCNDTRAP3A	In-line condensate collector for 3" PVC pipe	1	✓	✓	✓
BAYBASE205	Downflow subbase	8	✓	✓	✓
BAYFLTR206	Filter Access Door Kit (Downflow only)	2	✓	✓	✓
MAYBFERCOLKITA 1	Heat Shield, B size cabinet	3	✓	✓	✓
MAYCFERCOLKITA 1	Heat Shield, C size cabinet	3	✓	✓	✓
MAYDFERCOLKITA 1	Heat Shield, D size cabinet	3	✓	✓	✓
BAYSF1165	16x20 1" side return filter rack		✓	✓	✓
BAYSF1255	16x25 1" side return filter rack (bottom return for 17.5" cabinets)		✓	✓	✓
BAYBURNERSS	Stainless steel natural gas burner kit		✓	✓	✓

① Required on furnaces manufactured on or after 7/3/19 (with date code 19273 or after) when installed with a 4MXC or 4GXC coils in upflow or horizontal position. Not required in Downflow orientation.

For complete equipment / combination selections, installation instructions and warranty information, please refer to Product Data/Ratings and/or Installers Guides and Limited Warranty Handbooks.



## S9X1 – Single Stage High Efficiency ECM

**Table FUR-4-A — S9X1 High Efficiency 9 Speed ECM Motor, 1 Stage, Direct/Non-Direct Vent, Upflow/Horizontal Left/Horizontal Right Condensing Gas Furnace (120/1/60)<sup>③</sup>**

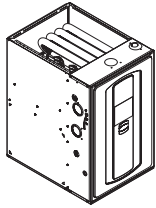

**S9X1  
Direct Vent  
Upflow**

Unit Model Number	Airflow In Tons	Nominal Output (Btuh)	ICS <sup>①</sup> AFUE	Flue Size (in)	Ignition Device	Uncrated Dimensions (in.) H x W x D	Shipping Weight (lbs.)	Max Fuse*	Filter Sizes**
S9X1B040U3PSBA	3	39,000	96.0 <sup>②</sup>	2, 3, 4	④	34 x 17 <sup>1</sup> / <sub>2</sub> x 28 <sup>3</sup> / <sub>4</sub>	122	15	16 x 25 x 1
S9X1B060U4PSBA	4	58,300	96.0 <sup>②</sup>	2, 3, 4	④	34 x 17 <sup>1</sup> / <sub>2</sub> x 28 <sup>3</sup> / <sub>4</sub>	130	15	16 x 25 x 1
S9X1B080U4PSBA	4	77,200	96.0 <sup>②</sup>	2, 3, 4	④	34 x 17 <sup>1</sup> / <sub>2</sub> x 28 <sup>3</sup> / <sub>4</sub>	135	15	16 x 25 x 1
S9X1C080U5PSBA	5	77,800	96.0 <sup>②</sup>	2, 3, 4	④	34 x 21 x 28 <sup>3</sup> / <sub>4</sub>	149	15	20 x 25 x 1
S9X1C100U5PSBA	5	97,400	95.0 <sup>②</sup>	2, 3, 4	④	34 x 21 x 28 <sup>3</sup> / <sub>4</sub>	155	15	20 x 25 x 1
S9X1D120U5PSBA	5	113,400	95.0 <sup>②</sup>	3, 4	④	34 x 24 <sup>1</sup> / <sub>2</sub> x 28 <sup>3</sup> / <sub>4</sub>	167	15	24 x 25 x 1

**Table FUR-4-B — S9X1 High Efficiency 9 Speed ECM Motor, 1 Stage, Direct/Non-Direct Vent, Downflow Condensing Gas Furnace (120/1/60)<sup>③</sup>**

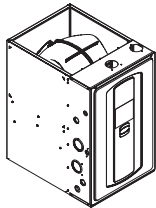

**S9X1  
Direct Vent  
Downflow**

S9X1B040D3PSBA	3	38,900	96.0 <sup>②</sup>	2, 3, 4	④	34 x 17 <sup>1</sup> / <sub>2</sub> x 28 <sup>3</sup> / <sub>4</sub>	122	15	(2)14 x 20 x 1
S9X1B060D3PSBA	3	57,600	96.0 <sup>②</sup>	2, 3, 4	④	34 x 17 <sup>1</sup> / <sub>2</sub> x 28 <sup>3</sup> / <sub>4</sub>	127	15	(2)14 x 20 x 1
S9X1B080D4PSBA	4	76,900	95.0 <sup>②</sup>	2, 3, 4	④	34 x 17 <sup>1</sup> / <sub>2</sub> x 28 <sup>3</sup> / <sub>4</sub>	135	15	(2)14 x 20 x 1
S9X1C100D5PSBA	5	96,800	96.0 <sup>②</sup>	2, 3, 4	④	34 x 21 x 28 <sup>3</sup> / <sub>4</sub>	155	15	(2)16 x 20 x 1
S9X1D120D5PSBA	5	115,500	95.0 <sup>②</sup>	3, 4	④	34 x 24 <sup>1</sup> / <sub>2</sub> x 28 <sup>3</sup> / <sub>4</sub>	167	15	(2)16 x 20 x 1

① Isolated Combustion System. AFUE may vary based on poise.

② Energy Star<sup>®</sup>.

③ Direct drive 9 speed motor is a high efficiency constant torque ECM blower motor.

④ Silicon Nitride Igniter.

\* Information subject to change. Please confirm with current Product Data/Service Facts for current factory production.

\*\* Filters are not shipped with furnace. For Upflow furnaces, the size is for a bottom return filter.

## S9B1 – Single Stage High Efficiency ECM

**Table FUR-4-C — S9B1 High Efficiency 9 Speed ECM Motor, 1 Stage, Direct/Non-Direct Vent, Upflow/Horizontal Left/Horizontal Right Condensing Gas Furnace (120/1/60)<sup>③</sup>**

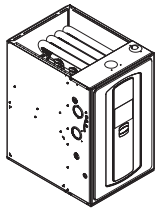

**S9B1  
Direct Vent  
Upflow**

Unit Model Number	Airflow In Tons	Nominal Output (Btuh)	ICS <sup>①</sup> AFUE	Flue Size (in)	Ignition Device	Uncrated Dimensions (in.) H x W x D	Shipping Weight (lbs.)	Max Fuse*	Filter Sizes**
S9B1B040U3PSAA	3	39,000	92.1 <sup>②</sup>	2, 3, 4	④	34 x 17 <sup>1</sup> / <sub>2</sub> x 28 <sup>3</sup> / <sub>4</sub>	122	15	16 x 25 x 1
S9B1B060U4PSAA	4	58,300	92.1 <sup>②</sup>	2, 3, 4	④	34 x 17 <sup>1</sup> / <sub>2</sub> x 28 <sup>3</sup> / <sub>4</sub>	130	15	16 x 25 x 1
S9B1B080U4PSAA	4	77,200	92.1 <sup>②</sup>	2, 3, 4	④	34 x 17 <sup>1</sup> / <sub>2</sub> x 28 <sup>3</sup> / <sub>4</sub>	135	15	16 x 25 x 1
S9B1C080U5PSAA	5	77,800	92.1 <sup>②</sup>	2, 3, 4	④	34 x 21 x 28 <sup>3</sup> / <sub>4</sub>	149	15	20 x 25 x 1
S9B1C100U5PSAA	5	97,400	92.1 <sup>②</sup>	2, 3, 4	④	34 x 21 x 28 <sup>3</sup> / <sub>4</sub>	155	15	20 x 25 x 1
S9B1D120U5PSAA	5	113,400	92.1 <sup>②</sup>	3, 4	④	34 x 24 <sup>1</sup> / <sub>2</sub> x 28 <sup>3</sup> / <sub>4</sub>	167	15	24 x 25 x 1

**Table FUR-4-D — S9B1 High Efficiency 9 Speed ECM Motor, 1 Stage, Direct/Non-Direct Vent, Downflow Condensing Gas Furnace (120/1/60)<sup>③</sup>**

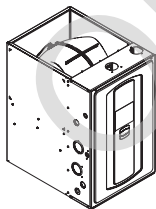

**S9B1  
Direct Vent  
Downflow**

S9B1B040D3PSAA	3	38,900	92.1 <sup>②</sup>	2, 3, 4	④	34 x 17 <sup>1</sup> / <sub>2</sub> x 28 <sup>3</sup> / <sub>4</sub>	122	15	(2)14 x 20 x 1
S9B1B060D3PSAA	3	57,600	92.1 <sup>②</sup>	2, 3, 4	④	34 x 17 <sup>1</sup> / <sub>2</sub> x 28 <sup>3</sup> / <sub>4</sub>	127	15	(2)14 x 20 x 1
S9B1B080D4PSAA	4	76,900	92.1 <sup>②</sup>	2, 3, 4	④	34 x 17 <sup>1</sup> / <sub>2</sub> x 28 <sup>3</sup> / <sub>4</sub>	135	15	(2)14 x 20 x 1
S9B1C100D5PSAA	5	96,800	92.1 <sup>②</sup>	2, 3, 4	④	34 x 21 x 28 <sup>3</sup> / <sub>4</sub>	155	15	(2)16 x 20 x 1
S9B1D120D5PSAA	5	115,500	92.1 <sup>②</sup>	3, 4	④	34 x 24 <sup>1</sup> / <sub>2</sub> x 28 <sup>3</sup> / <sub>4</sub>	167	15	(2)16 x 20 x 1

① Isolated Combustion System. AFUE may vary based on poise.

② Energy Star<sup>®</sup> - U.S. South.

③ Direct drive 9 speed motor is a high efficiency constant torque ECM blower motor.

④ Silicon Nitride Igniter.

\* Information subject to change. Please confirm with current Product Data/Service Facts for current factory production.

\*\* Filters are not shipped with furnace. For Upflow furnaces, the size is for a bottom return filter.

# Convertible Gas Furnaces

**Table FUR-5-A — Features**

	S9X1 Multi-Speed	S9B1 Multi-Speed
• Dry contact Humidifier/EAC hook-up capability	✓	—
• Insulated blower compartment	✓	—
• Meets requirements for 1% or less air leakage ①	✓	—
• Standard 34" height	✓	✓
• 3 Way poise Upflow furnace model (Upflow, Horizontal Left, Horizontal Right)	✓	✓
• Dedicated Downflow furnace model	✓	✓
• Front service access with easily accessible burners, sensors, orifices, switches, and other components	✓	✓
• Cabinet has no knockouts - Rubber and plastic plugs come installed from factory	✓	✓
• Gas can enter either side of cabinet	✓	✓
• Condensate can exit either side of cabinet in Upflow orientation	✓	✓
• Multiple venting options - Every model, every size will offer two venting options	✓	✓
• Integrated Furnace Control board with digital configuration, status, and fault codes	✓	✓
• Alpha-numeric diagnostic codes	✓	✓
• Adjustable blower off delay for heating and cooling	✓	✓
• Last six fault codes are stored (even with power loss)	✓	✓
• Stainless steel primary and secondary heat exchanger tubes	✓	✓
• Longer IFC wire harnesses allow door to be removed without disconnecting the harness	✓	✓
• Alternate bottom/left/right return air (upflow models only)	✓	✓
• Bottom panel	✓	✓
• Direct drive, 9 speed ECM blower motor - Constant torque ECM (electronically commutated motor)	✓	✓
• Dual PVC pipe venting (1 or 2 pipe option)	✓	✓
• Single-stage combination gas valve and regulator	✓	✓
• Gasketed inner and outer door	✓	✓
• Heavy gauge reinforced wrap-around steel cabinet	✓	✓
• Left/right condensate drain capability in vertical application	✓	✓
• Service diagnostics with faults reported on IFC board	✓	✓
• Manual reset flame roll out switches	✓	✓
• Mobile home approved with mobile home kit	✓	✓
• Multi-port in shot burners	✓	✓
• Service diagnostic capabilities	✓	✓
• <b>Vortica™ II</b> blower housing	✓	✓
• Slide out blower assembly on full-length rails	✓	✓
• Side return duct starter tabs (upflow models only)	✓	✓
• Silicon Nitride 120V hot surface igniter	✓	✓
• Multiple heating blower speeds	✓	✓
• <b>Limited lifetime heat exchanger warranty &amp; 10-year on all other functional parts with registration (Residential Use)</b>	✓	✓
• <b>Optional extended warranties available</b>	✓	✓

① 1.4% on S9B1 models.

\* Registered Limited Warranty terms are available when you register within 60 days of installation. You can register online at americanstandardair.com or by phone at 855-260-2975, otherwise American Standard Heating & Air Conditioning's Base Limited Warranty terms will apply. Base Limited Warranty information on specific products can be found on ASDealerNet.com.

**Table FUR-5-B — Optional Accessories**

Model Number	Description	Shipping Weight	S9X1 - 1 Stage 1 or 2 Pipe	S9B1 - 1 Stage 1 or 2 Pipe
BAYLPSS400C	LP Kit with Stainless Steel Burners	3	✓	✓
BAYHANG	Horizontal hanging kit	2	✓	✓
BAYVENT200B	Sidewall vent Termination Kit fo Direct vent furnaces	2	✓	✓
BAYVENTCN200B	Sidewall vent Termination Kit fo Direct vent furnaces for Canadian applications	2	✓	✓
BAYAIR30AVENTA	Concentric vent kit for 2, 2½ and 3" vent system	11	✓	✓
BAYAIR30CNVENT	Concentric vent kit for 2, 2½ and 3" vent system for Canadian applications	11	✓	✓
BAYREDUCE	Reducer Coupling for Canadian applications (CPVC)	1	✓	✓
BAYLIFTB	Dual return kit. B size extension	8	✓	✓
BAYLIFTC	Dual return kit. C size extension	9	✓	✓
BAYLIFTD	Dual return kit. D size extension	9	✓	✓
BAYMFGH200B	Manufactured/mobile home kit	1	✓	✓
BAYCNDTRAP2A	In-line condensate collector for 2" PVC pipe	1	✓	✓
BAYCNDTRAP3A	In-line condensate collector for 3" PVC pipe	1	✓	✓
BAYBASE205	Downflow subbase	8	✓	✓
BAYFLTR206	Filter Access Door Kit (Downflow only)	2	✓	✓
MAYBFERCOLKITA 2	Heat Shield, B size cabinet	3	✓	✓
MAYCFERCOLKITA 2	Heat Shield, C size cabinet	3	✓	✓
MAYDFERCOLKITA 2	Heat Shield, D size cabinet	3	✓	✓
BAYSF1165	16x20 1" side return filter rack	✓	✓	✓
BAYSF1255	16x25 1" side return filter rack (bottom return for 17.5" cabinets)	✓	✓	✓
BAYBURNERSS	Stainless steel natural gas burner kit	✓	✓	✓

② Required on furnaces manufactured on or after 7/3/19 (with date code 19273 or after) when installed with a 4MXC or 4GXC coils in upflow or horizontal position. Not required in Downflow orientation.

For complete equipment / combination selections, installation instructions and warranty information, please refer to Product Data/Ratings and/or Installers Guides and Limited Warranty Handbooks.

BUILT TO A HIGHER STANDARD<sup>®</sup>

**American Standard**<sup>®</sup>  
HEATING & AIR CONDITIONING

# Platinum 95 Convertible Gas Furnace Airflow Directions

Furnaces

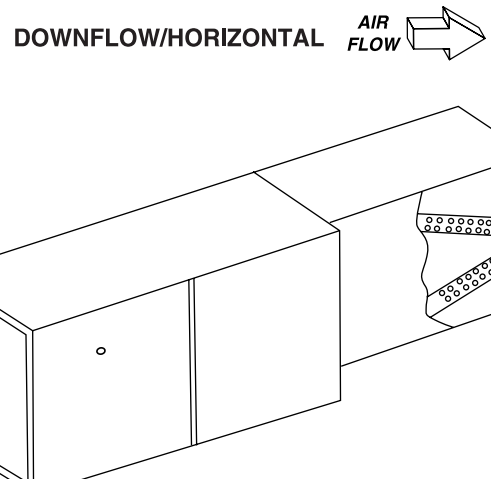
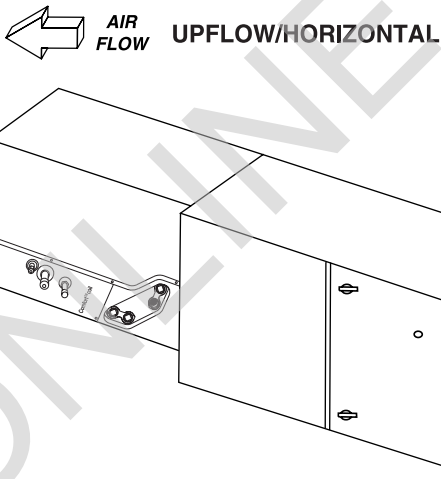
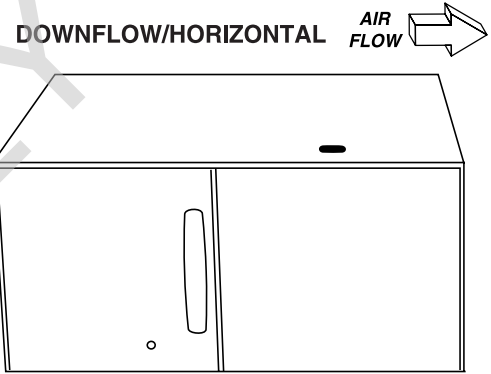
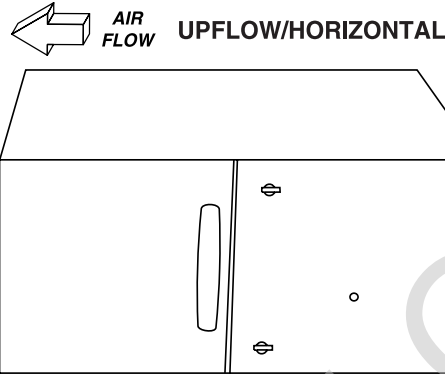
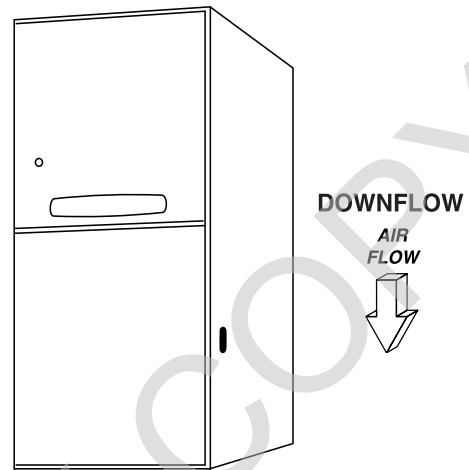
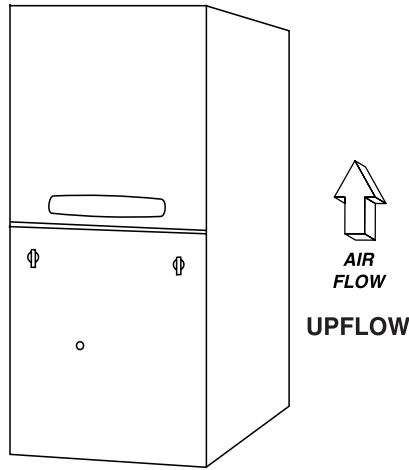

**Note:** The forty inch (40") height condensing downflow/horizontal and upflow/horizontal furnaces may only be rotated onto their left side. Connection brackets for coil/furnace alignment are included with the furnaces. The apex of the coil may point into or away from the airflow.

# Platinum 95 – Modulating, Communicating ECM Variable Speed

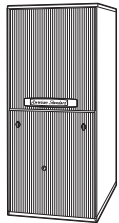

**Platinum 95  
Direct/Non-Direct  
Vent Upflow**



**Platinum 95  
Direct/Non-Direct  
Vent Downflow**

**Table FUR-7-A — Platinum 95 Variable Speed, Communicating, Modulating Direct/Non-Direct Vent, Upflow/Horizontal Left Condensing Gas Furnace (115/1/60)<sup>④⑤⑦</sup>**

Unit Model No.	Airflow In Tons	Output (Btuh)		ICS <sup>①</sup> AFUE Upflow / Horiz	Flue Size (in)	Uncrated Dimensions (in.) H x W x D	Shipping Weight (lbs.)	Max Fuse*	Filter Sizes**
		High Stage 100%	Low Stage 40% <sup>③</sup>						
AUHMB060ACV3VB	3	57,000	23,000	97.3 <sup>②</sup> / 96.5 <sup>②</sup>	2, 2 1/2, 3	40 x 17 1/2 x 28	158	15	17 x 25 x 1
AUHMB080ACV3VB	3	76,000	31,000	97.0 <sup>②</sup> / 96.2 <sup>②</sup>	2, 2 1/2, 3	40 x 17 1/2 x 28	168	15	17 x 25 x 1
AUHMC100ACV4VB	4	95,000	39,000	96.0 <sup>②</sup> / 95.2 <sup>②</sup>	2 1/2, 3	40 x 21 x 28	197	15	20 x 25 x 1
AUHMD120ACV5VB	5	114,000	52,000	97.0 <sup>②</sup> / 96.2 <sup>②</sup>	3	40 x 24 1/2 x 28	206	15	24 x 25 x 1

**Table FUR-7-B — Platinum 95 Variable Speed, Communicating Modulating Direct/Non-Direct Vent, Downflow/Horizontal Right Condensing Gas Furnace (115/1/60)<sup>④⑤⑦</sup>**

Unit Model No.	Airflow In Tons	Output (Btuh)		ICS <sup>①</sup> AFUE	Flue Size (in)	Ignition Device	Uncrated Dimensions (in.) H x W x D	Shipping Weight (lbs.)	Max Fuse*	Filter Sizes
		High Stage 100%	Low Stage 40%							
ADHMB060BCV3VB	3	57,000	22,800	95.0 <sup>②</sup>	2, 2 1/2, 3	⑥	40 x 17 1/2 x 28	160	15	(2)14 x 20 x 1
ADHMB080ACV3VB	3	76,000	30,400	96.0 <sup>②</sup>	2, 2 1/2, 3	⑥	40 x 17 1/2 x 28	168	15	(2)14 x 20 x 1
ADHMC100ACV4VB	4	96,000	38,400	96.0 <sup>②</sup>	2 1/2, 3	⑥	40 x 21 x 28	185	15	(2)16 x 20 x 1
ADHMD120BCV5VB	5	114,000	51,300	95.0 <sup>②</sup>	3	⑥	40 x 24 1/2 x 28	206	15	(2)16 x 20 x 1

Note: Variable speed furnaces should not be twinned and are not approved for twinning applications

① Isolated Combustion System. AFUE may vary based on poise.

② Energy Star®.

③ Low stage is equal to 45% for AUHMD120 model.

④ Furnace use in 24, non-communicating mode.

⑤ Direct drive variable speed motor is an ECM constant airflow blower motor.

⑥ Silicon Nitride

⑦ Must use communicating thermostat with AccuLink™ II control.

\* Information subject to change. Please confirm with current Product Data/Service Facts for current factory production.

\*\* For Upflow furnaces, the size is for a bottom return filter.

Furnaces

# Platinum 95, Convertible Gas Furnaces

**Airflow Directions:**

Downflow models when placed in horizontal position provide left to right airflow. Upflow models when placed in horizontal position provide right to left airflow.

Platinum 95  
AUHM/ADHM  
Modulating  
1 or 2 Pipe  
Variable Speed

**Table FUR-8-A — Features**

• <b>Comfort-R™</b> enhanced mode (cooling).....	✓
• <b>AccuLink™ II</b> system① .....	✓
• Meets requirements for 2% or less air leakage.....	✓
• Adjustable heating fan off timing.....	✓
• Alternate bottom/left/right return air (upflow models only).....	✓
• Blower door safety switch .....	✓
• Bottom panel (upflow models only) .....	✓
• Cleanable/Reusable high velocity filters .....	✓
• Complete front service access.....	✓
• Direct drive, variable speed ECM blower motor** .....	✓
• Downflow horizontal right (downflow models only).....	✓
• Dual PVC pipe venting (1 or 2 pipe option) .....	✓
• Modulating gas valve and regulator.....	✓
• Gasketed blower door (upflow models only).....	✓
• Heavy gauge reinforced wrap-around steel cabinet .....	✓
• Humidifier/EAC hook-up capability .....	✓
• Inner blower door panel (downflow models only).....	✓
• Insulated blower compartment 4 sides.....	✓
• Integrated solid state control w/self diagnostics.....	✓
• Left/right condensate drain capability in vertical application .....	✓
• Service diagnostics with faults reported at the user interface .....	✓
• <b>Lite Port™/Stored</b> diagnostics .....	✓
• Manual reset flame roll out switches .....	✓
• Multi-port in shot burners .....	✓
• Service diagnostic capabilities.....	✓
• Side return duct starter tabs (upflow models only) .....	✓
• Silicon Nitride hot surface igniter.....	✓
• Slide out blower assembly .....	✓
• Solid burner door (quiet operation).....	✓
• 20 gauge aluminized steel heat exchanger.....	✓
• 24 volt secondary fuse .....	✓
• Multiple heating blower speeds.....	✓
• Type 29-4C™ stainless steel secondary heat exchanger.....	✓
• Upflow horizontal left (upflow models only).....	✓
• Variable speed venter motor .....	✓
• <b>Limited lifetime heat exchanger warranty &amp; 10-year on all other functional parts with registration (Residential Use)②</b> .....	✓
• <b>Optional extended warranties available</b> .....	✓

Note: Variable speed furnaces should not be twinned and are not approved for twinning applications.

① Field configurable to 24V non-communicating mode.

② Registered Limited Warranty terms are available when you register within 60 days of installation. You can register online at americanstandardair.com or by phone at 855-260-2975, otherwise American Standard Heating & Air Conditioning's Base Limited Warranty terms will apply. Base Limited Warranty information on specific products can be found on ASDealerNet.com.

\*Constant torque ECM (electronically commutated motor).

\*\*Constant airflow ECM (electronically commutated motor).

Furnaces

# Platinum 95, Convertible Gas Furnaces

**Airflow Directions:**

Downflow models when placed in horizontal position provide left to right airflow. Upflow models when placed in horizontal position provide right to left airflow.

**Table FUR-9-A — Optional Accessories**

Model Number	Description	Shipping Weight	AUHM/ADHM Modulating 1 or 2 Pipe Variable Speed
BAYBASE205.....	Downflow subbase for downflow models only .....	8.....	✓
BAYFLTR200.....	External side filter rack.....	5.....	✓
BAYFLTR317①.....	Cleanable filter for 17.5" cabinet upflow only .....	2.....	✓
BAYFLTR321①.....	Cleanable filter for 21" cabinet upflow only .....	2.....	✓
BAYFLTR324①.....	Cleanable filter for 24.5" cabinet upflow only .....	2.....	✓
BAYLPKT220B.....	Propane conversion kit .....	2.....	✓
BAYLPSS220C.....	LP Kit with Stainless Steel Burners.....	2.....	✓
BAYRACK960A③.....	Filter rack kit for upflow models only (internal)②.....	5.....	✓
BAYAIR30AVENTA.....	Concentric vent kit for 2, 2½ and 3" vent system .....	11.....	✓
BAYAIR30CNVENT.....	Concentric vent kit for 2, 2½ and 3" vent system for Canadian applications .....	11.....	✓
BAYVENT200B.....	Sidewall vent Termination Kit fo Direct vent furnaces.....	2.....	✓
BAYVENTCN200B.....	Sidewall vent Termination Kit fo Direct vent furnaces for Canadian applications.....	2.....	✓
BAYVENT500A.....	Side vent kit for downflow models only.....	3.....	ADHM
BAYACCECOMM101.....	AccuClean™ hookup kit for communicating furnaces .....	1.....	✓

Note: Variable speed furnaces should not be twinned and are not approved for twinning applications.

① Contains one (1) high velocity filter.

② Internal filter rack for side or bottom return air. Includes 17 x 25" cleanable filter for use in side return applications. Bottom return applications require different sizes of filters which are not included. Airflow requirements over 1800 CFM require filters on both sides or a side and bottom or bottom only.

③ BAYRACK960A not allowed on right side return on AUH2B080A9V4V\*\* models.

Furnaces

BUILT TO A HIGHER STANDARD<sup>®</sup>

*American Standard*<sup>®</sup>

HEATING & AIR CONDITIONING

## Special Use Furnace Accessories

**Table FUR-10-A — High Altitude Pressure Switch 90%**

Model Number	Description	Used With	Shipping Weight
BAYSWT07AHALTA	1 Switch	AUHMB060, AHMB060	2
BAYSWT08AHALTA	1 Switch	AUHMD120, ADHMD120	2
BAYSWT09AHALTA	1 Switch	AUHMB080, ADHMB080, AUHMC100, ADHMC100	2

Furnaces

ONLINE ONLY COPY

## S8X2 – Two Stage ECM

**Table FUR-11-A — S8X2 2 Stage, Upflow/Downflow/Horizontal Left/Horizontal Right, Non-Condensing, Induced Draft Gas Furnace (120/1/60)②**

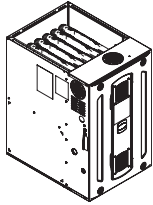

**S8X2  
4-Way  
Multi-Poise**

Unit Model Number	Airflow In Tons	Output (Btuh)		ICS① AFUE	Flue Size (in)	Ignition Device	Uncrated Dimensions (in.) H x W x D	Shipping Weight (lbs.)	Max Fuse*	Filter Sizes**
		Stage 2	Stage 1							
S8X2A040M3PSCA	2-3	32,200	20,900	80.0	4	③	34 x 14 <sup>1</sup> / <sub>2</sub> x 28 <sup>3</sup> / <sub>4</sub>	102	15	14 x 25 x 1
S8X2B060M4PSCA	4	48,700	31,500	80.0	4	③	34 x 17 <sup>1</sup> / <sub>2</sub> x 28 <sup>3</sup> / <sub>4</sub>	132	15	16 x 25 x 1
S8X2B080M4PSCA	3-4	65,000	42,500	80.0	4	③	34 x 17 <sup>1</sup> / <sub>2</sub> x 28 <sup>3</sup> / <sub>4</sub>	137	15	16 x 25 x 1
S8X2C080M5PSCA	4-5	64,900	41,800	80.0	4	③	34 x 21 x 28 <sup>3</sup> / <sub>4</sub>	142	15	20 x 25 x 1
S8X2C100M5PSCA	4-5	80,600	52,300	80.0	4	③	34 x 21 x 28 <sup>3</sup> / <sub>4</sub>	144	15	20 x 25 x 1
S8X2D120M5PSCA	5	98,000	67,800	80.0	4	③	34 x 24 <sup>1</sup> / <sub>2</sub> x 28 <sup>3</sup> / <sub>4</sub>	160	15	24 x 25 x 1
<b>Low NOx Models ④</b>										
S8X2A040M3PTCA	2-3	32,200	20,900	80.0	4	③	34 x 14 <sup>1</sup> / <sub>2</sub> x 28 <sup>3</sup> / <sub>4</sub>	102	15	14 x 25 x 1
S8X2B060M4PTCA	4	48,700	31,500	80.0	4	③	34 x 17 <sup>1</sup> / <sub>2</sub> x 28 <sup>3</sup> / <sub>4</sub>	132	15	16 x 25 x 1
S8X2B080M4PTCA	3-4	65,000	42,500	80.0	4	③	34 x 17 <sup>1</sup> / <sub>2</sub> x 28 <sup>3</sup> / <sub>4</sub>	137	15	16 x 25 x 1
S8X2C080M5PTCA	4-5	64,900	41,800	80.0	4	③	34 x 21 x 28 <sup>3</sup> / <sub>4</sub>	142	15	20 x 25 x 1
S8X2C100M5PTCA	4-5	80,600	52,300	80.0	4	③	34 x 21 x 28 <sup>3</sup> / <sub>4</sub>	144	15	20 x 25 x 1
S8X2D120M5PTCA	5	98,000	67,800	80.0	4	③	34 x 24 <sup>1</sup> / <sub>2</sub> x 28 <sup>3</sup> / <sub>4</sub>	160	15	24 x 25 x 1

① Isolated Combustion System.

② 9 Speed direct drive motor is an ECM constant torque motor.

③ Silicon Nitride Igniter.

④ These models comply with California 40ng/J Low NOx regulations.

\* Information subject to change. Please confirm with current Product Data/Service Facts for current factory production.

\*\* Filters are not shipped with furnace.

## S8X1 – Single Stage ECM

**Table FUR-11-B — S8X1 1 Stage, Upflow/Downflow/Horizontal Left/Horizontal Right, Non-Condensing, Induced Draft Gas Furnace (120/1/60)②**

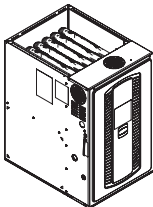

**S8X1  
4-Way  
Multi-Poise**

Unit Model Number	Airflow In Tons	Nominal Output (Btuh)	ICS① AFUE	Flue Size (in)	Ignition Device	Uncrated Dimensions (in.) H x W x D	Shipping Weight (lbs.)	Max Fuse*	Filter Sizes**
S8X1A040M3PSCA	2-3	32,300	80.0	4	③	34 x 14 <sup>1</sup> / <sub>2</sub> x 28 <sup>3</sup> / <sub>4</sub>	102	15	14 x 25 x 1
S8X1B040M2PSCA	2	32,500	80.0	4	③	34 x 17 <sup>1</sup> / <sub>2</sub> x 28 <sup>3</sup> / <sub>4</sub>	128	15	16 x 25 x 1
S8X1B060M4PSCA	4	48,700	80.0	4	③	34 x 17 <sup>1</sup> / <sub>2</sub> x 28 <sup>3</sup> / <sub>4</sub>	132	15	16 x 25 x 1
S8X1B080M4PSCA	3-4	65,100	80.0	4	③	34 x 17 <sup>1</sup> / <sub>2</sub> x 28 <sup>3</sup> / <sub>4</sub>	137	15	16 x 25 x 1
S8X1C080M5PSCA	4-5	64,700	80.0	4	③	34 x 21 x 28 <sup>3</sup> / <sub>4</sub>	142	15	20 x 25 x 1
S8X1C100M5PSCA	4-5	80,700	80.0	4	③	34 x 21 x 28 <sup>3</sup> / <sub>4</sub>	144	15	20 x 25 x 1
S8X1D120M5PSCA	5	98,000	80.0	4	③	34 x 24 <sup>1</sup> / <sub>2</sub> x 28 <sup>3</sup> / <sub>4</sub>	160	15	24 x 25 x 1
<b>Low NOx Models ④</b>									
S8X1A026M2PTCA	2	21,000	80.0	4	③	34 x 14 <sup>1</sup> / <sub>2</sub> x 28 <sup>3</sup> / <sub>4</sub>	102	15	14 x 25 x 1
S8X1A040M3PTCA	2-3	32,300	80.0	4	③	34 x 14 <sup>1</sup> / <sub>2</sub> x 28 <sup>3</sup> / <sub>4</sub>	102	15	14 x 25 x 1
S8X1B040M2PTCA	2	32,500	80.0	4	③	34 x 17 <sup>1</sup> / <sub>2</sub> x 28 <sup>3</sup> / <sub>4</sub>	128	15	16 x 25 x 1
S8X1B060M4PTCA	4	48,700	80.0	4	③	34 x 17 <sup>1</sup> / <sub>2</sub> x 28 <sup>3</sup> / <sub>4</sub>	132	15	16 x 25 x 1
S8X1B080M4PTCA	3-4	65,100	80.0	4	③	34 x 17 <sup>1</sup> / <sub>2</sub> x 28 <sup>3</sup> / <sub>4</sub>	137	15	16 x 25 x 1
S8X1C080M5PTCA	4-5	64,700	80.0	4	③	34 x 21 x 28 <sup>3</sup> / <sub>4</sub>	142	15	20 x 25 x 1
S8X1C100M5PTCA	4-5	80,700	80.0	4	③	34 x 21 x 28 <sup>3</sup> / <sub>4</sub>	144	15	20 x 25 x 1
S8X1D120M5PTCA	5	98,000	80.0	4	③	34 x 24 <sup>1</sup> / <sub>2</sub> x 28 <sup>3</sup> / <sub>4</sub>	160	15	24 x 25 x 1

① Isolated Combustion System.

② 9 Speed direct drive motor is an ECM constant torque motor.

③ Silicon Nitride Igniter.

④ These models comply with California 40ng/J Low NOx regulations.

\* Information subject to change. Please confirm with current Product Data/Service Facts for current factory production.

\*\* Filters are not shipped with furnace.



# S8B1 – Single Stage ECM

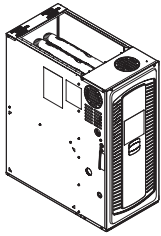

**S8B1  
4-Way  
Multi-Poise**

Furnaces

**Table FUR-12-A — S8B1 1 Stage, Upflow/Downflow/Horizontal Left/Horizontal Right, Non-Condensing, Induced Draft Gas Furnace (120/1/60)<sup>②</sup>**

Unit Model Number	Airflow In Tons	Nominal Output (Btuh)	ICS <sup>①</sup> AFUE	Flue Size (in)	Ignition Device	Uncrated Dimensions (in.) H x W x D	Shipping Weight (lbs.)	Max Fuse*	Filter Sizes**
S8B1A026M2PSCA	2	21,000	80.0	4	③	34 x 14 <sup>1</sup> / <sub>2</sub> x 28 <sup>3</sup> / <sub>4</sub>	102	15	14 x 25 x 1
S8B1A040M3PSCA	2-3	32,300	80.0	4	③	34 x 14 <sup>1</sup> / <sub>2</sub> x 28 <sup>3</sup> / <sub>4</sub>	102	15	14 x 25 x 1
S8B1B040M2PSCA	2	32,500	80.0	4	③	34 x 17 <sup>1</sup> / <sub>2</sub> x 28 <sup>3</sup> / <sub>4</sub>	128	15	16 x 25 x 1
S8B1B060M4PSCA	4	48,700	80.0	4	③	34 x 17 <sup>1</sup> / <sub>2</sub> x 28 <sup>3</sup> / <sub>4</sub>	132	15	16 x 25 x 1
S8B1B080M4PSCA	3-4	65,100	80.0	4	③	34 x 17 <sup>1</sup> / <sub>2</sub> x 28 <sup>3</sup> / <sub>4</sub>	137	15	16 x 25 x 1
S8B1C080M5PSCA	4-5	64,700	80.0	4	③	34 x 21 x 28 <sup>3</sup> / <sub>4</sub>	142	15	20 x 25 x 1
S8B1C100M5PSCA	4-5	80,700	80.0	4	③	34 x 21 x 28 <sup>3</sup> / <sub>4</sub>	144	15	20 x 25 x 1
S8B1D120M5PSCA	5	98,000	80.0	4	③	34 x 24 <sup>1</sup> / <sub>2</sub> x 28 <sup>3</sup> / <sub>4</sub>	160	15	24 x 25 x 1
<b>Low NOx Models<sup>④</sup></b>									
S8B1A026M2PTCA	2	21,000	80.0	4	③	34 x 14 <sup>1</sup> / <sub>2</sub> x 28 <sup>3</sup> / <sub>4</sub>	102	15	14 x 25 x 1
S8B1A040M3PTCA	2-3	32,300	80.0	4	③	34 x 14 <sup>1</sup> / <sub>2</sub> x 28 <sup>3</sup> / <sub>4</sub>	102	15	14 x 25 x 1
S8B1B040M2PTCA	2	32,500	80.0	4	③	34 x 17 <sup>1</sup> / <sub>2</sub> x 28 <sup>3</sup> / <sub>4</sub>	128	15	16 x 25 x 1
S8B1B060M4PTCA	4	48,700	80.0	4	③	34 x 17 <sup>1</sup> / <sub>2</sub> x 28 <sup>3</sup> / <sub>4</sub>	132	15	16 x 25 x 1
S8B1B080M4PTCA	3-4	65,100	80.0	4	③	34 x 17 <sup>1</sup> / <sub>2</sub> x 28 <sup>3</sup> / <sub>4</sub>	137	15	16 x 25 x 1
S8B1C080M5PTCA	4-5	64,700	80.0	4	③	34 x 21 x 28 <sup>3</sup> / <sub>4</sub>	142	15	20 x 25 x 1
S8B1C100M5PTCA	4-5	80,700	80.0	4	③	34 x 21 x 28 <sup>3</sup> / <sub>4</sub>	144	15	20 x 25 x 1
S8B1D120M5PTCA	5	98,000	80.0	4	③	34 x 24 <sup>1</sup> / <sub>2</sub> x 28 <sup>3</sup> / <sub>4</sub>	160	15	24 x 25 x 1

① Isolated Combustion System.

② 9 Speed direct drive motor is an ECM constant torque motor.

③ Silicon Nitride Igniter.

④ These models comply with California 40ng/J Low NOx regulations.

\* Information subject to change. Please confirm with current Product Data/Service Facts for current factory production.

\*\* Filters are not shipped with furnace.

## Convertible Gas Furnaces

**Table FUR-12-B — High Altitude Pressure Switch S8 Furnaces**

Model Number	Description	Used With	Shipping Weight
BAYSWT14AHALTB	1 Switch	S8X1C080M5PSAB <sup>①</sup> , S8X1C100M5PSAB <sup>①</sup> S8B1C080M5PSAB <sup>①</sup> , S8B1C100M5PSAB <sup>①</sup>	2
BAYSWT15AHALTA	1 Switch	S8X1B060M3PSAB <sup>①</sup> , S8X1B060M4PSAB <sup>①</sup> , S8X1B080M4PSAB <sup>①</sup> , S8B1B060M3PSAB <sup>①</sup> , S8B1B060M4PSAB <sup>①</sup> , S8B1B080M4PSAB <sup>①</sup>	2
BAYSWT16AHALTA	2 Switches	S8X2C080M5PSAB <sup>①</sup>	2
BAYSWT17AHALTA	2 Switches	S8X2B060M3PSAB, S8X2B060M4PSAB	2
BAYSWT18AHALTA	2 Switches	S8X2B080M4PSAB <sup>①</sup>	2
BAYSWT19AHALTA	2 Switches	S8X2C100M5PSAB <sup>①</sup>	2
BAYSWT20AHALTA	1 Switch	S8X1A026M2PSAB <sup>①</sup> , S8B1A026M2PSAB <sup>①</sup>	2
BAYSWT21AHALTA	1 Switch	S8X1A040M3PSAB <sup>①</sup> , S8X1A040M3PSAB <sup>①</sup> , S8X1B040M2PSAB <sup>①</sup> , S8B1B040M2PSAB <sup>①</sup>	2
BAYSWT22AHALTA	2 Switches	S8X2A040M3PSAB <sup>①</sup>	2
BAYSWT23AHALTA	2 Switches	S8X2B060M3PSAB <sup>②</sup> , S8X2B060M4PSA <sup>②</sup>	2

Note: S8X1D120M5, S8B1D120M5 and S8X2D120M5 do not require high altitude pressure switch kits.

① SAAA & later or TAAA & later

② SAAB & later or TAAA & later

# Convertible Gas Furnaces

**Table FUR-13-A — Features**

	S8X2 2 Stage	S8X1 1 Stage	S8B1 1 Stage
• Two stage combination gas valve and regulator .....	✓	—	—
• Dry contact Humidifier/EAC hook-up capability .....	✓	✓	—
• Insulated blower compartment ① .....	✓	✓	—
• Meets requirements for 1% or less air leakage ② .....	✓	✓	—
• Standard 34" height .....	✓	✓	✓
• 4 Way poise (Upflow, Downflow, Horizontal Left, Horizontal Right) .....	✓	✓	✓
• Front service access with easily accessible burners, sensors, orifices, switches, and other components .....	✓	✓	✓
• Cabinet has no knockouts - Plastic plugs come installed from factory .....	✓	✓	✓
• Gas can enter either side of cabinet .....	✓	✓	✓
• Multiple venting options - Every model, every size offers two venting options .....	✓	✓	✓
• Integrated Furnace Control board with digital configuration, status, and fault codes .....	✓	✓	✓
• Alpha-numeric diagnostic codes .....	✓	✓	✓
• Adjustable blower off delay for heating and cooling .....	✓	✓	✓
• Last six fault codes are stored (even with power loss) .....	✓	✓	✓
• Alumined heat exchanger tubes .....	✓	✓	✓
• Longer IFC wire harnesses allow door to be removed without disconnecting the harness .....	✓	✓	✓
• Alternate bottom/left/right return air (except downflow) .....	✓	✓	✓
• Bottom panel .....	✓	✓	✓
• Direct drive, 9 speed Constant Torque ECM blower motor .....	✓	✓	✓
• Heavy gauge reinforced wrap-around steel cabinet .....	✓	✓	✓
• Service diagnostics with faults reported on IFC board .....	✓	✓	✓
• Manual reset flame roll out switches .....	✓	✓	✓
• Multi-port in shot burners .....	✓	✓	✓
• Service diagnostic capabilities .....	✓	✓	✓
• <b>Vortica™ II</b> blower housing .....	✓	✓	✓
• Slide out blower assembly on full-length rails .....	✓	✓	✓
• Side return duct starter tabs .....	✓	✓	✓
• Silicon Nitride 120V hot surface igniter .....	✓	✓	✓
• Multiple heating blower speeds .....	✓	✓	✓
• <b>20-year registered limited warranty on the heat exchanger &amp; 10-year on all other functional parts (Residential Use)*</b> .....	✓	✓	✓
• <b>Optional extended warranties available</b> .....	✓	✓	✓

① 14.5" cabinets do not have blower compartment insulation

② 1.4% leakage on S8B1 models

\* Registered Limited Warranty terms are available when you register within 60 days of installation. You can register online at americanstandardair.com or by phone at 855-260-2975, otherwise American Standard Heating & Air Conditioning's Base Limited Warranty terms will apply. Base Limited Warranty information on specific products can be found on ASDealerNet.com.

**Table FUR-13-B — Optional Accessories**

Model Number	Description	Shipping Weight	S8X2 2 Stage	S8X1 1 Stage	S8B1 1 Stage
BAYLPSS400C.....	LP Kit with Stainless Steel Burners.....	3.....	✓	(except 026)	(except 026)
BAYLPSS410B.....	LP Kit with Stainless Steel Burners.....	3.....	—	S8X1A026	S8B1A026
BAYHANG .....	Horizontal hanging kit.....	2.....	✓	✓	✓
BAYSF1165A .....	1" SlimFit Box with MERV 4 Filter (side return).....	5.....	✓	✓	✓
BAYVENT600A①.....	Internal venting kit .....	11.....	✓	✓	✓
BAYVENT800B .....	Masonry Chimney Vent Kit .....	11.....	✓	✓	✓
PIP02095.....	U fitting for gas piping.....	1.....	✓	✓	✓
BAYLIFTB.....	Dual return kit. B cabinet size extension .....	8.....	✓	✓	✓
BAYLIFTC.....	Dual return kit. C cabinet size extension .....	9.....	✓	✓	✓
BAYLIFTD.....	Dual return kit. D cabinet size extension .....	9.....	✓	✓	✓
BAYBASE205.....	Downflow subbase .....	8.....	✓	✓	✓
BAYFLTR206.....	Filter Access Door Kit (Downflow only) .....	2.....	✓	✓	✓
BAYSF1165.....	16x20 1" side return filter rack.....	.....	✓	✓	✓
BAYSF1255.....	16x25 1" side return filter rack (bottom return for 17.5" cabinets).....	.....	✓	✓	✓
BAYBURNERSS .....	Stainless steel natural gas burner kit .....	.....	✓	✓	✓

① Compatible with B, C, and D width cabinets.

BUILT TO A HIGHER STANDARD<sup>®</sup>

**American Standard**<sup>®</sup>  
HEATING & AIR CONDITIONING

# Platinum 80, Gold 80v Airflow Directions

Furnaces

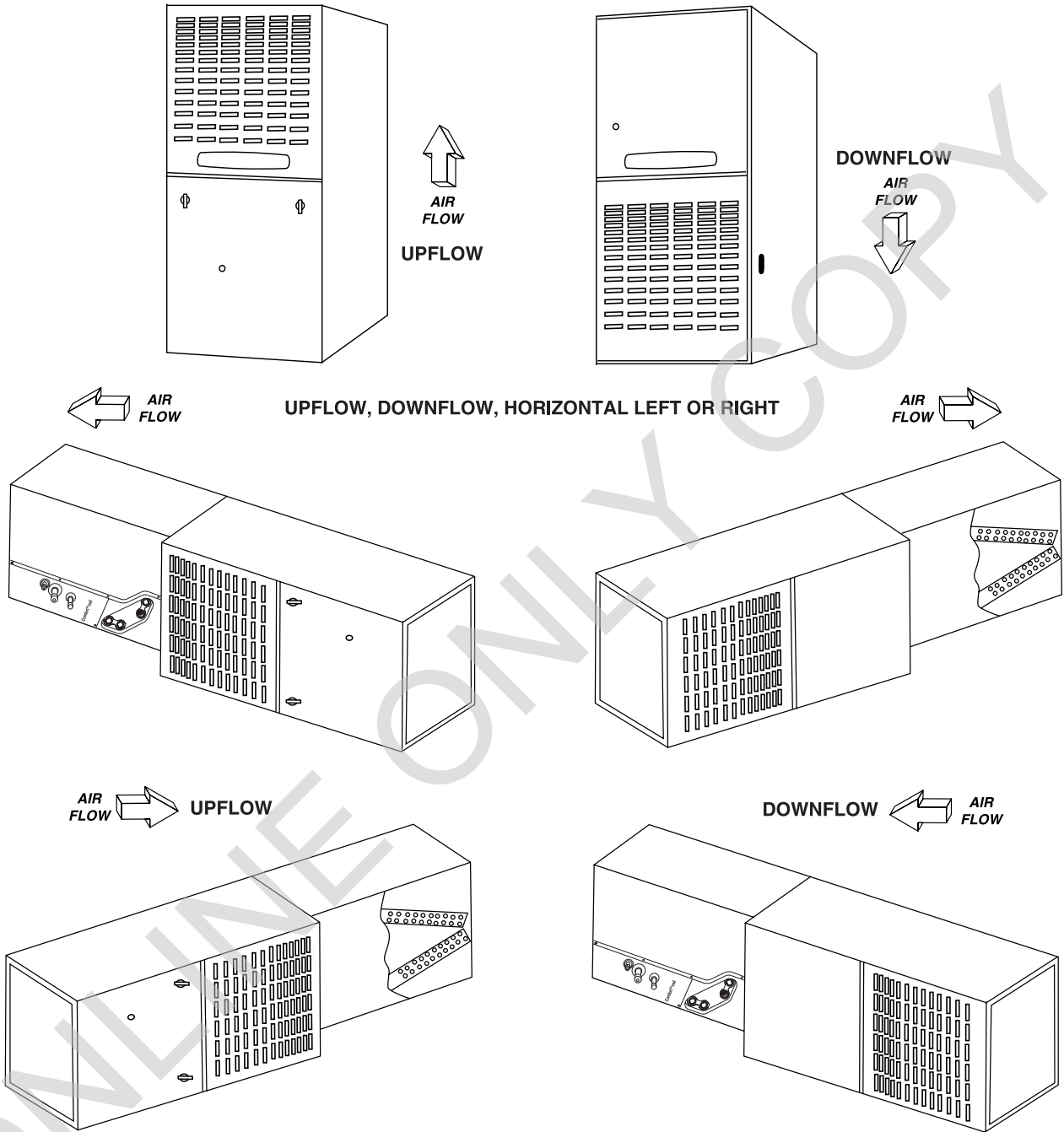

**Note:** The non-condensing, forty inch (40") height furnaces may be laid on either side for horizontal application. Connection brackets for coil/furnace alignment are included with the furnaces. The apex of the coil may point into or away from the airflow.



# Platinum 80, Gold 80v, Convertible Gas Furnaces

Furnaces

**Table FUR-16-A — Features**

	AUD2/ACV ADD2/ACV 2-Stage ①	AUD2-9V ADD-9V 2-Stage ①
• Service diagnostics with faults reported at the user interface .....	✓	—
• <b>AccuLink™</b> system.....	✓	—
• Can be connected in communicating or 24V non-communicating modes .....	✓	—
• User interface for system configuration - Easy to use navigation buttons and plain text for clear description of features .....	✓	—
• 3-way vent option on downflow models (top,right or left) (downflow models only) .....	✓	—
• 24 volt secondary fuse.....	—	✓
• Variable speed ECM blower motor* .....	✓	✓
• <b>Comfort-R™</b> enhanced mode (cooling) .....	✓	✓
• Meets requirements for 2% or less air leakage.....	✓	✓
• Adjustable heating fan off timing .....	✓	✓
• Alternate bottom/left/right return air (upflow models only).....	✓	✓
• Attractive color accents .....	✓	✓
• Blower door safety switch.....	✓	✓
• Bottom Panel (upflow models only) .....	✓	✓
• Cleanable/reusable high velocity filters .....	✓	✓
• Common vent capability .....	✓	✓
• Complete front service access .....	✓	✓
• Gasketed blower door.....	✓	✓
• Heavy gauge reinforced wrap-around steel cabinet.....	✓	✓
• Horizontal left/right without conversion required.....	✓	✓
• Humidifier/EAC hook-up capability .....	✓	✓
• Inner blower door panel (downflow models only) .....	✓	✓
• Insulated blower compartment 4 sides (upflow models only) .....	✓	✓
• Integrated solid state control w/self diagnostics.....	✓	✓
• Left/right gas connection.....	✓	✓
• Manual reset flame roll out switches.....	✓	✓
• Masonry Chimney Venting w/BAYVENT800B (upflow models).....	✓	✓
• Multi-port in shot burners.....	✓	✓
• Perfect fit door latches (upflow models only) .....	✓	✓
• Right or left hand side knock out for venting (downflow models only) .....	✓	✓
• Selectable cooling fan off delay eliminates need for time delay relay.....	②	✓
• Service diagnostic capabilities .....	✓	✓
• Side return starter tabs (upflow models only) .....	✓	✓
• Silicon Nitride hot surface igniter with adaptive heat up .....	✓	✓
• Single door filter access .....	✓	✓
• Slide out blower assembly.....	✓	✓
• 20 gauge aluminized steel heat exchanger .....	✓	✓
• Four heating blower speeds .....	✓	✓
• Two speed venter motor .....	✓	✓
• Two-stage gas valve .....	✓	✓
• <b>Limited lifetime heat exchanger warranty &amp; 10-year on all other functional parts with registration (Residential Use)③</b> .....	✓	✓
• <b>Optional extended warranties available</b> .....	✓	✓

Note: Variable speed furnaces should not be twinned and are not approved for twinning applications.

① Variable Speed

② Selectable through thermostat

③ Registered Limited Warranty terms are available when you register within 60 days of installation. You can register online at americanstandardair.com or by phone at 855-260-2975, otherwise American Standard Heating & Air Conditioning's Base Limited Warranty terms will apply. Base Limited Warranty information on specific products can be found on ASDealerNet.com.

\*Constant airflow ECM (electronically commutated motor).

\*\*Constant airflow ECM (electronically commutated motor).

# Platinum 80, Gold 80v, Convertible Gas Furnaces

**Table FUR-17-A — Optional Accessories**

Model Number	Description	Shipping Weight	AUD2-ACV/ADD2-ACV 2 Stage Variable Speed	AUD2-9V/ ADD2-9V 2-Stg. Variable Speed
BAYBASE205	Downflow subbase for downflow models only	8	✓	✓
BAYFLTR200	Side Filter Rack (External)	5	✓	✓
BAYFLTR206	Filter Access Door Kit (Downflow only)	2	✓	✓
BAYFLTR321 <sup>①</sup>	Cleanable filter for 21" cabinet upflow only	2	✓	✓
BAYFLTR324 <sup>①</sup>	Cleanable filter for 24.5" cabinet upflow only	2	✓	✓
BAYLPKT210B	Propane conversion kit	1	✓	✓
BAYLPSS210B	LP Kit with Stainless Steel Burners	1	✓	✓
BAYRACK960A <sup>②</sup>	Filter Rack Kit for upflow models only (internal)	5	✓	✓
BAYVENT800B	Masonry chimney vent kit for upflow models only	2	✓	✓

Note: Variable speed furnaces should not be twinned and are not approved for twinning applications.

<sup>①</sup> Contains one (1) high velocity filter.

<sup>②</sup> Internal filter rack for side or bottom return air. Includes 17 x 25" cleanable filter for use in side return applications. Bottom return applications require different sizes of filters which are not included. Airflow requirements over 1800 CFM require filters on both sides or a side and bottom or bottom only.

ONLINE ONLY COPY

Furnaces

BUILT TO A HIGHER STANDARD<sup>®</sup>

*American Standard*<sup>®</sup>

HEATING & AIR CONDITIONING

## High Efficiency Oil Furnaces

---

# Ordering Information

---

## Variable and Non-Variable Speed High Efficiency Oil Furnaces

American Standard Oil Furnaces are available from your local distributor.

For availability and support, contact your local distributor.

Furnaces



Intertek





# L9X1 - Single Stage, Ultra-Low NOx Gas Furnace



L9X1

**Table FUR-20-A — L9X1 - Single Stage, Ultra-Low NOx Gas Furnace**

Model Number	Airflow in Tons	Output (BTUH)	ICS AFUE	Flue Size (in.)	Ignition Device	Uncrated Dimensions (in.)			Shipping Weight (lbs.)	Max. Fuse	Filter Sizes
						H	W	D			
L9X1A050U3VSAB	3	48,000	95	2, 3, 4	Silicon Nitride	34½	14¼	28	115	15	14 x 25 x 1
L9X1B070U4VSAB	4	67,000	95	2, 3, 4	Silicon Nitride	34½	17½	28	133	15	16 x 25 x 1
L9X1C100U5VSAB	5	95,000	95	2, 3, 4	Silicon Nitride	34½	21	28	150	20	20 x 25 x 1

**Table FUR-20-B — Features**

	L9X1
• 9 speed, Constant Torque blower motor.....	✓
• 34.5" Cabinet height.....	✓
• 3-Way Poise (Upflow, Horizontal Left, Horizontal Right).....	✓
• Single Stage Operation.....	✓
• Aluminized steel, tubular primary heat exchanger.....	✓
• Stainless steel secondary heat exchanger.....	✓
• Insulated blower compartment.....	✓
• Meets 14 ng/J NOx emission requirements.....	✓
• Meets requirements for 2% or less cabinet air leakage.....	✓
• <b>Limited Lifetime heat exchanger warranty &amp; 10-year on all other functional parts with registration (Residential Use)*</b> .....	✓

\* Registered Limited Warranty terms are available when you register within 60 days of installation. You can register online at [americanstandardair.com](http://americanstandardair.com) or by phone at 855-260-2975, otherwise American Standard Heating & Air Conditioning's Base Limited Warranty terms will apply. Base Limited Warranty information on specific products can be found on [ASDealerNet.com](http://ASDealerNet.com).

**Table FUR-20-C — Optional Accessories**

Model Number	Description	Used With
BAYSPACER	6 inch vertical coil spacer	L9X1 Furnaces
BAYHANG	Horizontal hanging kit	All Upflow Furnaces
BAYVENT200B	Sidewall Vent Termination Kit	All Condensing Furnaces
BAYAIR30AVENTA	Concentric Vent Kit	All Condensing Furnaces
BAYLIFTC	Dual Return Kit (C size extension)	C Cabinet Upflow Furnaces
BAYCNDTRAP2A	Inline Condensate Trap Kit used with Special Venting on 2" Vent Pipe	All Condensing Furnaces
BAYCNDTRAP3A	Inline Condensate Trap Kit used with Special Venting on 3" Vent Pipe	All Condensing Furnaces

Furnaces

# AccuClean™ Whole Home Air Cleaner



## AccuClean™ Whole House Air Cleaner:

- **AccuClean™** removes up to 99.98% of allergens from the filtered air
- Removes particles down to 0.1 micron in size
- **AccuClean™** Whole Home Air Cleaner removes more than 99% of the surrogate for the virus that causes COVID-19 within 30 minutes.
- Outperforms HEPA type filters, and up to 100 times more effective than a standard 1" filter
- Constructed of painted 18 gage metal to protect the filter and internal electronics
- Power door provides easy access to internal components and features a filter status display as well as safety interlocks that automatically shut down the power when the door is opened for maintenance or cleaning
- Designed for flush fit on both sides and rear of equipment cabinet
- No transitions required on **AccuClean™** applications
- Gaskets included with the air cleaner
- **AccuLink II™** communicating or 24 volt capability
- **10-Year Limited Warranty with registration\***
- **AccuClean™** is certified as **asthma & allergy friendly™** by AAFA (Asthma and Allergy Foundation of America)

**Table IAQ-1-A – Air Handler – 24 Volt AccuClean™ Whole House Air Cleaner**

Model Number	Airflow Range	AccuClean™ Air Handler Width	Uncrated Dimensions (in.) H x W x D	Shipping Weight
EFD175DLAH000A	300-1200	17½ inch	7½ x 17½ x 21	37
EFD215DLAH000A	300-1200	21½ inch	7½ x 21½ x 21	42
EFD235DLAH000A	350-1600	23½ inch	7½ x 23½ x 21	44
EFD260DLAH000A	400-2000	26 inch	7½ x 26 x 21	46

**Table IAQ-1-B – Upflow / Side Return Furnace – 24 Volt AccuClean™ Whole House**

Model Number	Airflow Range	AccuClean™ Furnace Width	Uncrated Dimensions (in.) H x W x D	Shipping Weight
EFD145DLFR000A	300-1200	14½ inch <sup>①</sup>	7½ x 14½ x 27	39
EFD175DLFR000A	300-1600	17½ inch <sup>①</sup>	7½ x 17½ x 27	43
EFD210DLFR000A	300-2000	21 inch <sup>②</sup>	7½ x 21 x 27	47
EFD245DLFR000A	400-2000	24½ inch <sup>②</sup>	7½ x 24½ x 27	49

**Table IAQ-1-C – Downflow Furnace – 24 Volt AccuClean™ Whole House**

Model Number	Airflow Range	AccuClean™ Furnace Width	Uncrated Dimensions (in.) H x W x D	Shipping Weight
EFD17DDLFR000A	300-1600	17½ inch	7½ x 17½ x 21	37
EFD21DDLFR000A	300-2000	21 inch	7½ x 21 x 21	41

**Table IAQ-1-D — Accessories – American Standard AccuClean™ Whole House**

Model Number	Description	Used With	Shipping Weight
BAYTRANS12024	120 to 24 Volt Transformer	All EFD Air Cleaners	6

① Side return no transition required.

② Side return transition required.

**Table IAQ-1-E — Air Handler Filters**

ifD Filter	AIR HANDLER MODEL NUMBER	
	A	B
EFD215	21½	19
EFD235	23½	21
EFD260	26	23½

**Table IAQ-1-F — Upflow Furnace Filters**

ifD Filter	FURNACE MODEL NUMBER	
	A	B
EFD145	14½	12
EFD175	17½	15
EFD210	21	18½
EFD245	24½	22

**Table IAQ-1-G — Downflow Furnace Filters**

ifD Filter	FURNACE MODEL NUMBER	
	A	B
EFD14D	14½	11⅞
EFD17D	17½	14⅞
EFD21D	21	18⅞
EFD24D	24½	21⅞

\* Registered Limited Warranty terms are available when you register within 60 days of installation. You can register online at americanstandardair.com or by phone at 855-260-2975, otherwise American Standard Heating & Air Conditioning's Base Limited Warranty terms will apply. Base Limited Warranty information on specific products can be found on ASDealerNet.com.

For complete equipment / combination selections, installation instructions and warranty information, please refer to Product Data/Ratings and/or Installers Guides and Limited Warranty Handbooks.

# Perfect Fit™ Filter Accessories

**Table IAQ-2-A — Furnace Cartridge Media**

Model Number	Description	Qty	Enclosure Used with	Shipping Weight
BAYFTFREXM2	Expandable 5" Cartridge Media Filter	2 / Box	14 1/2 - 24 1/2 x 27	5

**Table IAQ-2-B — Air Handler Cartridge Media**

Model Number	Description	Qty	Enclosure Used with	Shipping Weight
BAYFTAHEXM2	Expandable 5" Cartridge Media Filter	2 / Box	21 1/2 - 26 x 21	5

**Table IAQ-2-C — Furnace Frames - Subject to existing inventory**

Model Number	Description	Qty	Enclosure Used with	Shipping Weight
BAYFRAME145①	Expandable Media Filter	1 / Box	14 1/2	5
BAYFRAME175①	Expandable Media Filter	1 / Box	17 1/2	5
BAYFRAME210①	Expandable Media Filter	1 / Box	21	5
BAYFRAME245①	Expandable Media Filter	1 / Box	24 1/2	5

**Table IAQ-2-D — Air Handler Frames - Subject to existing inventory**

Model Number	Description	Qty	Enclosure Used with	Shipping Weight
BAYFRAME215①	Expandable Media Frame	1 / Box	21	5
BAYFRAME235①	Expandable Media Frame	1 / Box	23 1/2	5
BAYFRAME260①	Expandable Media Frame	1 / Box	26	5

① Includes one filter.

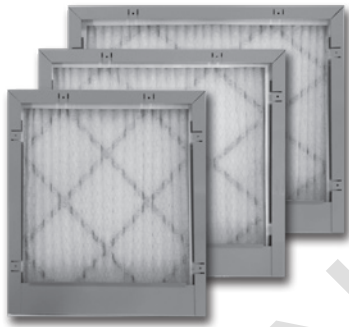

## SlimFit Filters

- Available in all cabinet widths for the TEM Air Handlers.
- Available for the S-Series Furnaces with side return.
- Polyslate Gray 18 gauge steel painted frame to match cabinet
- Low profile 2" depth cabinet
- Hinged front door for easy filter replacement
- MERV 4 rated pleated filter included for recurring revenue on SlimFit sizes. Will also accommodate off the shelf retail filters.
- Easy Installation and competitively priced
- Fully insulated R-4.2 door
- Insulated cabinet to prevent sweating

**Table IAQ-2-E - SlimFit Filters**

Part Number	Part Description	Dimensions (in.)
BAYSF1165BAA	1" Filter and Frame (Side Return Furnace)	16 <sup>5</sup> / <sub>8</sub> x 20 <sup>3</sup> / <sub>8</sub> x 2
BAYSF1185BAA	1" Filter and Frame, 18 <sup>1</sup> / <sub>2</sub>	18 <sup>1</sup> / <sub>2</sub> x 21 x 2
BAYSF1235BAA	1" Filter and Frame, 23 <sup>1</sup> / <sub>2</sub>	23 <sup>1</sup> / <sub>2</sub> x 21 x 2
BAYSF11255BAA	1" Filter and Frame (Side Return Furnace)	16 <sup>5</sup> / <sub>8</sub> x 25 <sup>1</sup> / <sub>2</sub> x 2
BAYSF1265BAA	1" Filter and Frame, 26 <sup>1</sup> / <sub>2</sub>	26 <sup>1</sup> / <sub>2</sub> x 21 x 2
FLRSF1165*	1" Media Filter (Side Return Furnace)	16 <sup>1</sup> / <sub>4</sub> x 20 <sup>1</sup> / <sub>4</sub> x <sup>3</sup> / <sub>4</sub>
FLRSF1185*	1" Media Filter	17 <sup>3</sup> / <sub>4</sub> x 19 <sup>3</sup> / <sub>4</sub> x <sup>3</sup> / <sub>4</sub>
FLRSF1235*	1" Media Filter	22 <sup>3</sup> / <sub>4</sub> x 19 <sup>3</sup> / <sub>4</sub> x <sup>3</sup> / <sub>4</sub>
FLRSF1255*	1" Media Filter (Side Return Furnace)	16 <sup>1</sup> / <sub>4</sub> x 25 <sup>1</sup> / <sub>4</sub> x <sup>3</sup> / <sub>4</sub>
FLRSF1265*	1" Media Filter	25 <sup>3</sup> / <sub>4</sub> x 19 <sup>3</sup> / <sub>4</sub> x <sup>3</sup> / <sub>4</sub>

\*Shipped in cartons of 12

BUILT TO A HIGHER STANDARD

**American Standard**

HEATING & AIR CONDITIONING

# QuikBox™ Media Cabinet and Filters



- New Cost Improved Replacement for TFM Perfect Fit Media Filter
- 9 Perfect Fit Sizes to match Air Handler or Furnace Cabinet dimensions
- 5" Depth 18 Gauge Metal Painted Cabinet w/ Fully insulated R-4.2 Door
- MERV 11 Collapsible "Shirt-Box" type filter included
- Air Tite Door Construction with Gasketing and Quarter Turn Easy Open Latch
- Cabinet Gasketing included for improved leakage at equipment connection
- **QuikBox** Replacement Filters are Backward Compatible to Fit Every TFM FilterBox

**Table IAQ-3-A– QuikBox™ Cabinet with Filter**

Old Perfect Fit Model	New QuikBox Model	Nominal Cabinet Size H x W x D	Airflow Range Cfm	Shipping Weight
TFM175B0FR0	EQBFM175A0FR11	5" x 17.5" x 27"	300-1500	20
TFM17DA0FR0	EQBFM17DA0AH11	5" x 17.5" x 21"	300-1600	20
TFM210B0FR0	EQBFM210A0FR11	5" x 21.0" x 27"	300-2000	22
TFM215B0AH0	EQBFM215A0AH11	5" x 21.5" x 21"	300-1400	20
TFM235B0AH0	EQBFM235A0AH11	5" x 23.5" x 21"	300-1700	22
TFM245B0FR0	EQBFM245A0FR11	5" x 24.5" x 27"	400-2000	24
TFM260B0AH0	EQBFM260A0AH11	5" x 26.0" x 21"	400-2000	24
N/A	EQBFM165A0FR11	5" x 20.5" x 16.75"	400-1600	20
N/A	EQBFM185A0AH11	5" x 18.5" x 21"	400-1600	22

**Table IAQ-3-B– QuikBox™ Replacement Filters (MERV11)**

Perfect Fit Furnace	Old Filter Part Number	Dimensions (in.) H x W x D	New Filter Part Number	Efficiency Rating
TFM145B0FR0	BAYFTFR14M2	13.7 x 26 x 4.7	FLRQB5FR14M11	MERV 11
TFM175B0FR0	BAYFTFR17M2	16.7 x 26 x 4.7	FLRQB5FR17M11	MERV 11
TFM210B0FR0	BAYFTFR21M2	20.2 x 26 x 4.7	FLRQB5FR21M11	MERV 11
TFM245B0FR0	BAYFTFR24M2	23.7 x 26 x 4.7	FLRQB5FR24M11	MERV 11
New	N/A	15.75 x 19 x 4.7	FLRQB5FR16M11	MERV 11
TFM17DA0FR0	BAYFTDN17M2	16.7 x 20 x 4.7	FLRQB5DN17M11	MERV 11

**Table IAQ-3-C– QuikBox™ Replacement Filters (MERV11)**

Perfect Fit Furnace	Old Filter Part Number	Dimensions (in.) H x W x D	New Filter Part Number	Efficiency Rating
TFM215B0AH0	BAYFTA21M2	20.7 x 20 x 4.7*	FLRQB5AH21M11	MERV 11
TFM235B0AH0	BAYFTA23M2	22.7 x 20 x 4.7	FLRQB5AH23M11	MERV 11
TFM260B0AH0	BAYFTA26M2	25.2 x 20 x 4.7	FLRQB5AH26M11	MERV 11
New	N/A	17.75 x 20 x 4.7	FLRQB5AH18M11	MERV 11

\* Note:  
Fits phased out TFM21DAFR0 Perfect Fit Cabinet

Indoor Air Quality

# Humidifiers Steam



## Steam Humidifier w/ Manual Control

- Electrode Type Steam Canister means fast, easy, low cost maintenance.\*
- Six Different Capacities In One Unit to satisfy any application from 11.5 gallons per day to 34.6 gallons per day.
- Automatic Shut Down after 72 hours of inactivity; unit will drain to eliminate standing water.
- Easy Mounting Flexibility to your existing duct work or can be remotely mounted.
- Choose Precise Relative Humidity % Settings based on your needs and outdoor conditions. Works with American Standard Home-enabled controls without the need for additional controls.
- Humidity "On Demand" uses your HVAC system blower to distribute humidified air throughout your home without a call for heating from your furnace or heat pump.
- 10-Year Standard Warranty includes all functional Parts. Registered Limited Warranty available.\*\*
- All Inclusive Package means there is nothing else to purchase. Includes manual humidistat and blower relay. American Standard Home-enabled control is optional.

\*Replace once a year

## Steam Humidifier Low Conductivity w/ Manual Control

- **American Standard**<sup>®</sup> model 800LC Steam Humidifier is recommended for all 120V installations.
- Two Different Capacities at 11.5 gallons per day and 16 gallons per day.
- Comes with model 8043 LCRP Canister
- Faster start-up and 35% more electrode surface area than model 800 with 120v application

**Table IAQ-4-A — Steam Humidifier Models**

Part Number	Part Description	Dimensions - W"xD"xH"	Weight (lbs)
EHUMD800ASM00C	Steam Humidifier w/ Manual Control	10.125 x 7.125 x 20.875	23
EHUMD800BSMLCC	Steam Humidifier Low Conductivity w/ Manual Control	10.125 x 7.125 x 20.875	23

**Table IAQ-4-B — Specifications: Humidifier with Humidistat**

Conductivity	Grains/Gal	Hardness	Recommended Model installed at 208/240v
75-100	0-3	Naturally Soft	Model 800LC
100-300	3-9	Naturally Soft	Model 800LC
300-500	9-15	Slightly Hard	Model 800
500-650	15-20	Moderately Hard	Model 800
650-850	20-25	Hard	Model 800
850-1250	25-36	Very Hard	Model 800
above 1250	above 36	Extremely Hard	Installation Not Recommended

**Table IAQ-4-C — Accessories**

Model Number	Description
8043RP	Canister, Rplc, 6-Pk, Serv First
8043LCRP	Replacement Steam Canister-Low Conductivity Model
5625RP	Humidistat, Manual, Serv First
5628RP	Drain Trap Assy, Serv First
5629RP	Air Flow Switch, Serv First
5630RP	High Humidity Switch, Serv First
5632RP	Condensate Pump Kit, Serv First
56TR	Convertible Automatic Humidifier Control, Trane Brand

1. What model is recommended for 120VAC installations?
  - a. The Model 800LC and 80LC canister are recommended regardless of water conditions.

\*\* Registered Limited Warranty terms are available when you register within 60 days of installation. You can register online at [americanstandardair.com](http://americanstandardair.com) or by phone at 855-260-2975, otherwise American Standard Heating & Air Conditioning's Base Limited Warranty terms will apply. Base Limited Warranty information on specific products can be found on ASDealerNet.com.

For complete equipment / combination selections, installation instructions and warranty information, please refer to Product Data/Ratings and/or Installers Guides and Limited Warranty Handbooks.

# Humidifiers Fan Powered and Bypass



**Fan Powered Humidifier**



**Bypass Humidifier**

## Fan Powered Humidifier

- Flow Through Fan Powered Humidifier
- High Performance Humidifier Delivers up to 18 Gallons per Day
- Automatic Humidifier Control with O.D. Sensor for up to 50% more Humidity
- Front Cover Access for easy replacement of humidifier pad
- Aluminum Humidifier Pad Treated with Ceramic Coating for Enhanced Pad Performance
- Reliable Brass Solenoid Valve w/Stainless Steel Valve Seat
- UV Resistant Cabinet and Scale Control Insert
- Saddle Valve
- Polyslate Gray Housing matches Furnace Cabinet Color
- 120V Power Line Cord
- 110V Primary/24VA Transformer

## Bypass Humidifier

- EHUMD300A Bypass delivers up to 17 Gallons per day
- EHUMD200A delivers up to 12 Gallons per day
- EHUMD300A Automatic Humidifier Control and O.D. Sensor for up to 50% more Humidity
- EHUMD200A Manual Humidifier Control
- UV Resistant Cabinet and Scale Control Insert
- Front Cover Access for easy replacement of humidifier pad
- Aluminum Humidifier Pad Treated with Ceramic Coating for Enhanced Pad Performance
- Reliable Brass Solenoid Valve w/Stainless Steel Valve Seat
- Field Convertible Duct Connection, Left or Right Side
- Built in Summer / Winter Damper
- Saddle Valve
- Polyslate Gray Housing matches Furnace Cabinet Color
- 110V Primary / 24V Secondary 10VA Transformer

**Table IAQ-5-A — Specifications: Humidifier with Humidistat**

Model Number	Description	Used With	Shipping Weight
EHUMD500APA00D <sup>①④</sup>	Fan Powered Humidifier	All Furnace Models	20
EHUMD300ABA00C <sup>②</sup>	Large Bypass Humidifier	All Furnace Models	15
EHUMD200ABAM00C <sup>③</sup>	Small Bypass Humidifier	All Furnace Models	14

- ① Includes Automatic Humidifier Control (Duct Mount Only).  
 ② Includes Automatic Humidifier Control (Duct Mount Only) and 120/24V transformer.  
 ③ Includes Manual Humidifier Control and 120/24V transformer.  
 ④ Not applicable for horizontal installations.

**Table IAQ-5-B — Accessories**

Model Number	Description	Used With
BAYPAD02A1310A	Large Humidifier Pad 13"x10"	EHUMD500,300A
BAYPAD01A1010A	Small Humidifier Pad 9-7/8"x9-5/8"	EHUMD200A
ECONTH01AAUTOA	Automatic Humidifier Control	EHUMD200A
BAYRLY10ASENSA	Current Sensing Relay	All
BAYPLT01AMHCOA	Adapter Plate (Duct Mount)	Manual Humidifier Control
5804 American Standard Badge	American Standard Badge Bag (10 ea.)	EHUMD200, EHUMD300
5806 American Standard Badge	American Standard Badge Bag (10 ea.)	EHUMD500
BAYKIT01ASMBPA	Small bypass humidifier maintenance kit	EHUMD200A
BAYKIT01ALGBPA	Large bypass humidifier maintenance kit	EHUMD300A
BAYKIT01ALGFPA	Large fan powered humidifier maintenance kit	EHUMD500

BUILT TO A HIGHER STANDARD<sup>®</sup>

**American Standard<sup>®</sup>**  
HEATING & AIR CONDITIONING

## Whole Home Dehumidifiers with Optional Ventilation



- Full line of horizontal dehumidifiers from 70 ppd to 120 ppd of moisture removal
- Exclusive XT coil technology means higher efficiency humidity removal rates than standard units
- All Units are Energy Star<sup>®</sup> rated
- All units come with optional ventilation capability to meet ASHRAE 62.2 Ventilation requirements
- Units can be ducted to and wired to operate with HVAC system or can used independently of HVAC system with internal blower and wired control
- Units come standard with MERV 13 filter for superior indoor air quality
- 5 Year Unit Replacement Warranty for Refrigeration Circuit Failures (Registered Warranty)\*
- Engineered for low temperature operation providing comfort year round
- Optional digital controller for outdoor air ventilation and humidity control
- Designed for quiet operation



**Table IAQ-6-A — Specifications: American Standard<sup>®</sup> Whole Home Dehumidifiers with Optional Ventilation**

Model Number	Description	Dimensions- W" x H" x L"	Weight (lbs.)
EDHUM70HAH1MNBA	Whole home 70 pint ventilating dehumidifier, 1,800 sq. ft. capacity	12 x 12 x 28	55
EDHUM098AH1MNBA	Whole home 98 pint ventilating dehumidifier, 2,300 sq. ft. capacity	14.5 x 19.5 x 32.375	81
EDHUM120AH1MNAA	Whole home 120 pint ventilating dehumidifier, 3,000 sq. ft. capacity	14.4 x 21.0 x 32.2	91

**Table IAQ-6-B — Accessories**

Model Number	Description	Dimensions- W" x H" x L"	Weight (lbs.)
4037724	Filter (qty 1), 9" x 11" x 1" MERV 13 (70)	14 x 10 x 8	1 lb.
4037736	Filter (qty 12) for 9" x 11" x 1" MERV 13 (70)	12 x 12 x 12	3 lb.
4037722	Filter (qty 1) 14" x 17.5" x 1.75" MERV 13 (98, 120)	20 x 20 x 7	3 lb.
4037732	Filter (qty 12) 14" x 17.5" x 1.75" MERV 13 (98, 120)	22 x 19 x 15	13 lb.
4036695	Hang kit (70, 98, 120)	24 x 7 x 7	7 lb.
4023672	6" motorized damper	10 x 10 x 10	3 lb.
4023647	8" gravity damper (70)	13 x 13 x 13	5 lb.
4024375	10" gravity damper (98, 120)	13 x 13 x 13	5 lb.
4028539	D30 control	9 x 6 x 2	1 lb.
4028407	D30 control with remote	9 x 6 x 4	1 lb.

Indoor Air Quality

\*\* Registered Limited Warranty terms are available when you register within 60 days of installation. You can register online at [americanstandardair.com](http://americanstandardair.com) or by phone at 855-260-2975, otherwise American Standard Heating & Air Conditioning's Base Limited Warranty terms will apply. Base Limited Warranty information on specific products can be found on ASDealerNet.com.

For complete equipment / combination selections, installation instructions and warranty information, please refer to Product Data/Ratings and/or Installers Guides and Limited Warranty Handbooks.

BUILT TO A HIGHER STANDARD

*American Standard*<sup>®</sup>

HEATING & AIR CONDITIONING

## Inline Ventilator



- Full ECM motor, adjustable airflow from 30 to 130 cfm
- Programmable to prevent temperature and humidity extremes
- Includes MERV 8 filter for improved indoor air quality
- Quiet fan (.4 – 1.6 Sones) is virtually undetectable when operating
- “On - Off” switch on unit or controlled by 24V remote wired smart thermostat with ventilation software
- Compact design fits between framing members and comes with hanger brackets

**Table IAQ-7-A — Specifications: Envirowise™ QF130V Inline Ventilator**

Part Number	Part Description	Dimensions - W"xD"xH"	Weight (lbs)
EVENQF130V1NAAA	Inline Ventilator Fan with Relay	15.75 x 12.75 x 23	18

**Table IAQ-7-B — Accessories**

Model Number	Description	Dimensions - W"xD"xH"	Weight (lbs)
E1650024	Heater Model EQH400	14.5 x 14 x 10.25	8.25
E1650025	Heater Model EQH900	14.5 x 14 x 10.25	8.25
E1650026	6" Motorized Damper	6.3 x 9.45 x 10.63	4.5
E1955001	6" Screened Wall Cap	9 x 9 x 17	3
E1650123	2 Pack 10x10x2 Filter	10 x 10 x 4	0.95



BUILT TO A HIGHER STANDARD<sup>®</sup>

**American Standard**<sup>®</sup>  
HEATING & AIR CONDITIONING

# Energy Recovery Ventilator (ERV)



- **American Standard** ERV technology for all seasons and climates
- Static plate energy transfer core for efficient transfer of heat and moisture
- Passive defrost - condensate drain not required
- Pressure ports are accessible through front panel without door removal
- 2 "Guillotine" type dampers are included to balance for correct airflow
- Multi position mounting
- Percent Timer (PT) control included with ERV for simple, automatic operation
- Optional Push Button (PB) control connects to PT control
- Pull-down door latches for quick service access
- Heavy gauge, powder painted steel cabinet
- Permanently lubricated motor bearings (ball bearings)
- 6" and 8" double collar duct connections for EERVR100 and 200
- 8" round compatible duct connection for EERVR300
- Closed cell foam gasketing for insulation integrity
- 1" duct board insulation with cleanable foil face
- May be installed in conditioned and unconditioned spaces
- Cabinet / Door color: American Standard Polyslate Gray
- **5 year Parts Warranty. No registration required**
- **Registered Limited Warranty 10-years\***
- **MERV 8 replaceable filter included**

**Table IAQ-8-A — Specifications: ERV**

Model Number	Nominal Airflow (CFM)	Power Supply	Uncrated Dimensions (In.) H x W x D	Shipping Weight
EERVR100A1P00B <sup>①</sup>	130	120/1/60	20 <sup>1</sup> / <sub>8</sub> x 28 <sup>3</sup> / <sub>4</sub> x 13	65
EERVR200A1P00B <sup>①</sup>	200	120/1/60	20 <sup>1</sup> / <sub>8</sub> x 28 <sup>3</sup> / <sub>4</sub> x 23 <sup>7</sup> / <sub>8</sub>	85
EERVR300A1P00B <sup>①</sup>	300	120/1/60	20 <sup>1</sup> / <sub>8</sub> x 28 <sup>3</sup> / <sub>4</sub> x 23 <sup>7</sup> / <sub>8</sub>	95

<sup>①</sup> Percent Timer Control included with the ERV.

**Table IAQ-8-B — Specifications: ERV**

Model Number	Sensible Recovery Effectiveness (32°F)	Latent Recovery (32°F)	Total Recovery (95°F)
EERVR100A1P00B	72% @ 124 cfm	55% @ 124 cfm	46% @ 126 cfm
EERVR200A1P00B	78% @ 181 cfm	62% @ 181 cfm	52% @ 180 cfm
EERVR300A1P00B	70% @ 295 cfm	51% @ 295 cfm	43% @ 295 cfm

**Table IAQ-8-C — Optional Accessories**

Model Number	Description	Used With	Shipping Weight
ECONTV10APBC0A	Point of Use Push Button Control	ERV models 100, 200, 300	1
FLR08618	Filters - 2 per pack	ERV models 100	1
FLR08619	Filters - 2 per pack	ERV models 200, 300	1
BAYWHT10AVENTA <sup>②</sup>	6 inch White Vinyl Ventilation Hood	ERV models 100, 200	1
BAYBRN10AVENTA <sup>②</sup>	6 inch Brown Vinyl Ventilation Hood	ERV models 100, 200	1
BAYGLV10AVENTA <sup>②</sup>	8 inch Galvanized Ventilation Hood	ERV models 300	2

<sup>②</sup> Qty 1.

\* Registered Limited Warranty terms are available when you register within 60 days of installation. You can register online at [americanstandardair.com](http://americanstandardair.com) or by phone at 855-260-2975, otherwise American Standard Heating & Air Conditioning's Base Limited Warranty terms will apply. Base Limited Warranty information on specific products can be found on [ASDealerNet.com](http://ASDealerNet.com).

For complete equipment / combination selections, installation instructions and warranty information, please refer to Product Data/Ratings and/or Installers Guides and Limited Warranty Handbooks.

BUILT TO A HIGHER STANDARD<sup>®</sup>

**American Standard<sup>®</sup>**  
HEATING & AIR CONDITIONING

## Conventional 24 Volt Smart Thermostat

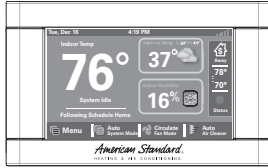

**GOLD 824  
ACONT824AS52DB**



### ACONT824AS52DB

- Energy Star<sup>®</sup> certified
- Z-Wave Plus Bridge Inside
- American Standard Diagnostics ①
- WiFi or Ethernet connection
- Control from a smartphone, tablet, or computer ①②
- 4.3" Color touchscreen
- 7 Day programmable with up to four schedules per day
- Five day weather forecast, weather radar, and weather alerts ①
- Indoor relative humidity display
- Enhanced dehumidification (cooling)
- 2 Auxiliary dry contacts control 2 of the following: Whole house humidifier, dehumidifier, or ventilation system
- Test modes and alert diagnostics
- Screen access restrictions
- Over-the-air software upgrade ①
- Local software upgrade option
- Color: Designer Silver
- Retail Package Sleeve
- Limited Warranty: 5 yr. base/10 yr.

### Application:

- Conventional gas/electric, heat pump, and dual fuel systems
- Conventional boiler systems (forced air only)
- Conventional HVAC systems:
  - 2 Heat / 2 cool
  - Heat Pump systems: Up to 5 stages heat / 2 stages cool (2 compressor heat - 3 auxiliary heat / 2 cooling)
  - Heat Pump switchover valve: selectable "with cool or with heat"
- Remote wired indoor temperature sensor (optional) ZZSENSAL0400AA
- Remote wireless indoor temperature and humidity sensor (optional): ZSENS930AW00MA
- Remote wired outdoor temperature sensor (optional) BAYSEN01ATEMPA
- PWM Circuit (BK terminal): controls indoor unit variable speed blower
- Wall cover plate BAYCOVR800A

### Dimensions:

- Product: 5.43"w x 3.39"h x 1.30"d
- Display: 4.15"w x 2.65"h

For complete equipment / combination selections, installation instructions and warranty information, please refer to Product Data/Ratings and/or Installers Guides and Limited Warranty Handbooks.

CCZS-1

Effective 1/1/22  
14-1011-39

① Requires internet service and American Standard Home™ smart home system registration.  
② American Standard Home™ remote climate access is included with the purchase for up to 8 Connected Controls per home. Adding accessories or additional controls to your American Standard Home™ system may require a monthly subscription.

BUILT TO A HIGHER STANDARD<sup>®</sup>

*American Standard*<sup>®</sup>

HEATING & AIR CONDITIONING

## Conventional 24 Volt Smart Thermostat

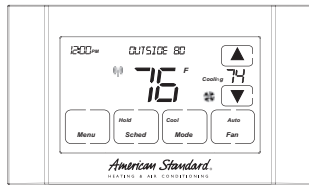

**SILVER 724  
ACONT724AS42DA**

### ACONT724AS42DA

- Mobile app compatible (download American Standard Home) ①②
- American Standard Diagnostics ①
- Control from a smartphone, tablet, or computer ①②
- 4.3" diagonal black and white touchscreen
- 7 Day programmable with up to 4 schedules per day
- Humidity sensor and RH display
- Remote temperature sensor connections (1 indoor/1 outdoor)
- Auxiliary & compressor heat lockouts
- Auxiliary dry contact
- Enhanced dehumidification (cooling)
- PWM Circuit (BK terminal): controls indoor unit variable speed blower
- Energy Savings Mode (ESM)
- Screen lock and guest lock
- Service test modes
- Upgradable software
- Color: Designer Silver
- Retail Package Sleeve
- Limited Warranty: 1 yr. base/5 yr.

### Application:

- Up to 4 Stages Heat/2 Stages Cool
- Conventional gas/electric, heat pump, and dual fuel systems
- Conventional boiler systems (baseboard & radiators)
- Remote wired indoor temperature sensor (optional): ZZSENSAL0400AA
- Remote wired outdoor temperature sensor (optional): BAYSEN01ATEMPA
- Wall cover plate BAYCOVR800A
- Z-Wave Bridge is required for control of Z-Wave devices, such as lighting, door locks, etc., and remote climate access. The Z-Wave Bridge is purchased separately. ①②

### Dimensions:

- Product: 5.9"w x 3.47"h x .95"d
- Display: 3.8"w x 2.3"h

① Requires internet service and American Standard Home™ smart home system registration.

② American Standard Home™ remote climate access is included with the purchase for up to 8 Connected Controls per home. Adding accessories or additional controls to your American Standard Home™ system may require a monthly subscription. Remote access is via most web-enabled smartphones, tablets and computers.

③ Requires Z-Wave Bridge

For complete equipment / combination selections, installation instructions and warranty information, please refer to Product Data/Ratings and/or Installers Guides and Limited Warranty Handbooks.

## AccuLink™ Communicating Smart Thermostat

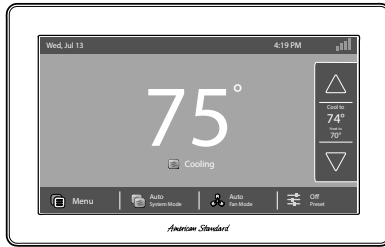

**PLATINUM 1050  
AZON1050AC52ZA**

### AZON1050AC52ZA

- Z-Wave Plus Bridge Inside
- American Standard Diagnostics ①
- WiFi or Ethernet connection
- Control from a smartphone, tablet, or computer ①②
- 7" diagonal color touchscreen
- 1-Touch Presets - Home, Away, Sleep
- 7 Day programmable with up to four schedules per day
- Customizable Home Screen
- Runtime History
- Allergy and Quick Clean Air Cycles
- Smart Continuous Fan
- Adjustable Continuous Airflow (35-100%)
- Screen access restrictions
- Dealer Contact Widget
- Service, Filter, Humidifier, UV Light, Air Cleaner Reminders
- Five day weather forecast, weather radar, and weather alerts ①
- Indoor relative humidity display
- Test modes and alert diagnostics
- Over-the-air Software Upgrade ①
- Local Software Upgrade option
- Color: Designer Silver
- Retail Package Sleeve
- Limited Warranty: 5 yr. base/10 yr.

### Application:

- **AccuComfort™** Variable Speed
- **AccuLink™ II** Two Stage Systems
- **AccuLink™ II** Zoning Systems
- **AccuComfort™** Variable speed outdoor cooling or heat pump unit combined with S-Series non-communicating variable speed furnace and "C" model Relay Panel
- Relay panel (BAY24VRP52DC) is required when applied with conventional systems (Gas Electric, Heat Pump, Dual Fuel, Boilers - forced air only)
- Relay Panel Supports:
  - Up to 5 stages heat, 2 stages cool
  - Connections for Remote indoor and outdoor temperature sensors
  - 3 Dry Auxiliary Contacts to control whole house humidifier, dehumidifier, or ventilation system
- Remote wired indoor temperature sensor (optional) ZZSENSAL0400AA
- Remote wireless indoor temperature and humidity sensor (optional): ZSENS930AW00MA
- Remote wired outdoor temperature sensor (optional) BAYSEN01ATEMPA

### Dimensions:

- Product: 7.2"w x 4.5"h x 1.2"d
- Display: 6.1"w x 3.3"h

① Requires internet service and American Standard Home™ smart home system registration.  
② American Standard Home™ remote climate access is included with the purchase for up to 8 Connected Controls per home. Adding accessories or additional controls to your American Standard Home™ system may require a monthly subscription. Remote access is via most web-enabled smartphones, tablets and computers.

# AccuLink™ Communicating Smart Thermostat

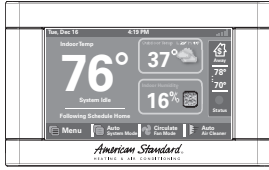

**PLATINUM 850  
ACONT850AC52UB**



## ACONT850AC52UB

- Z-Wave Plus Bridge
- WiFi or Ethernet connection
- Control from a smartphone, tablet, or computer ①②
- 4.3" diagonal color touchscreen
- Compatible with **AccuLink™** communicating systems (variable speed and two stage)
- Compatible with conventional 24 volt HVAC, heating, heat pump, and dual fuel systems when used with accessory relay panel model BAY24VRPAC52DC
- 7 Day programmable with up to four schedules per day
- Five day weather forecast, radar, and alerts ①
- Indoor relative humidity display
- Test modes and alert diagnostics
- American Standard Diagnostics ①
- Over-the-air software upgrades ①
- Local software upgrade option
- Color: Designer Silver
- Wall cover plate BAYCOVR800A
- Retail Package Sleeve
- Limited Warranty: 5 yr. base/10 yr.

## Application:

- **AccuLink™ II** communicating systems (variable speed and two stage)
- Variable speed outdoor cooling combined with S-Series non-communicating variable speed furnace and "C" model Relay Panel
- Conventional gas/electric, heat pump, dual fuel systems, or boiler systems (forced air only) with use of relay panel model BAY24VRPAC52DB. Relay panel controls up to 5 stages heat, 2 stages cool, remote indoor and outdoor connections, humidifier, dehumidifier, and ventilation system.
- Remote wired indoor temperature sensor (optional) ZZSENSAL0400AA
- Remote wireless indoor temperature and humidity sensor (optional): ZSENS930AW00MA
- Remote wired outdoor temperature sensor (optional) BAYSEN01ATEMPA

## Dimensions:

- Product: 5.43"w x 3.39"h x 1.30"d
- Display: 4.15"w x 2.65"h

## Wall Cover Plate

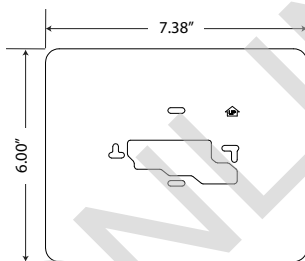

**BAYCOVR800A**

## BAYCOVR800A

### Application:

- Use with  
ACONT624AS42DA,  
ACONT724AS42DA,  
ACONT824AS52DA,  
ACONT850AC52UA

## Dimensions:

- 7.38" w x 6.00" h
- Finish: Silver

- ① Requires internet service and connection to American Standard Home™ smart home system.  
② American Standard Home™ remote climate access is included with the purchase of up to 8 Connected Controls per home. Adding accessories to your American Standard Home™ system may require a monthly subscription for remote access via most web-enabled smartphones, tablets and computers.

BUILT TO A HIGHER STANDARD<sup>®</sup>

*American Standard*<sup>®</sup>  
HEATING & AIR CONDITIONING

## Zoning Communicating Sensor with Display

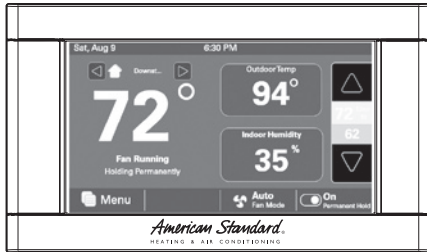

**AZON1040AC52ZA**

### AZON1040AC52ZA

- For use with **AccuLink™II** Zoning Systems
- 3-Wire Communicating Zone Sensor
- 4.3" diagonal color touchscreen
- Zone Mode - Auto only
- Fan Mode - Auto/On
- Displays Zone Temperature & Relative Humidity.
- Average multiple zone temp sensors
- Displays Outdoor Temperature (American Standard Home registration or wired ODT required)
- Clean Screen Function
- 3 Levels of Restricted Access
- Fahrenheit or Celsius
- Adjust zone Setpoint at 1040, 1050, and American Standard Home Smart Home
- Schedule 1040, 1050, and American Standard Home Smart Home
- Zone Schedule Override
  - Permanent Hold
- Enter zone name at 1040 and 1050
- Over the Air upgrades via the 1050
- Screen color with backlit options
- Screensaver options

### Dimensions:

- Product: 5.43"w x 3.39"h x 1.30"d
- Display: 4.15"w x 2.65"h

### Storage Temperature:

- -40°F to 170°F, 0% - 95% RH

### Operating Temperature:

- 32°F - 120°F, 5% - 90% RH non-condensing

# Conventional 24 Volt HVAC System Interface Relay Panel for AccuLink™ Controls

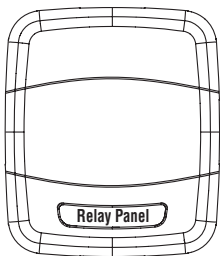

**BAY24VRPAC52DC**

## **BAY24VRPAC52DC — With AUX Contact Control**

- 5 Heat (Gas, Oil, Electric)/2 Cool/  
Heat Pump/Dual Fuel
- Optional remote indoor temperature  
connection point
- Optional remote outdoor temperature  
connection point
- LED stage indicators
- Removable low voltage terminal  
blocks for easy service and  
replacement
- **AUX Contacts**
  - Whole-house Dehumidifier Control
  - Ventilation Control
  - Humidifier Control
- Relay Panel provides support for the  
following equipment combination:
  - Variable speed heat pump and  
cooling units
  - S-Series Non-communicating  
Variable Speed Furnace
  - ACONT850AC52UA or  
AZON1050AC52ZA

## **Dimensions:**

- 8.0" width x 9.3" height x 1.9" depth

## **Storage Temperature:**

- -40° to 175°F, 5% - 95% RH  
non-condensing

## **Operating Temperature:**

- -40° to 150°F, 5% - 95% RH  
non-condensing

# AccuLink™ Platinum 1050 Control Component Overview

## Communicating System

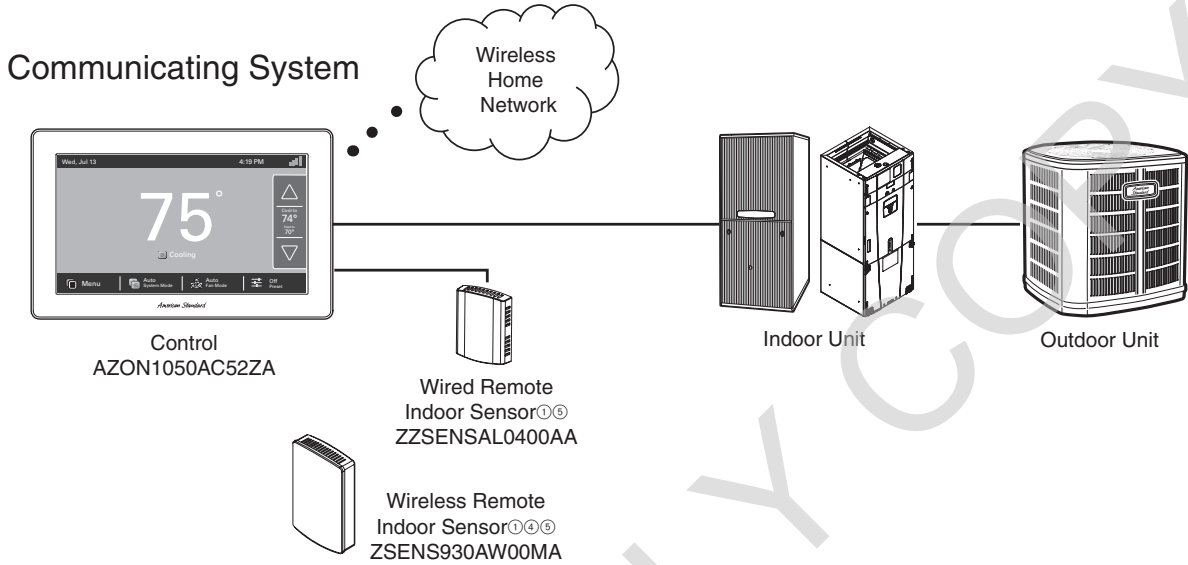

## 24V System

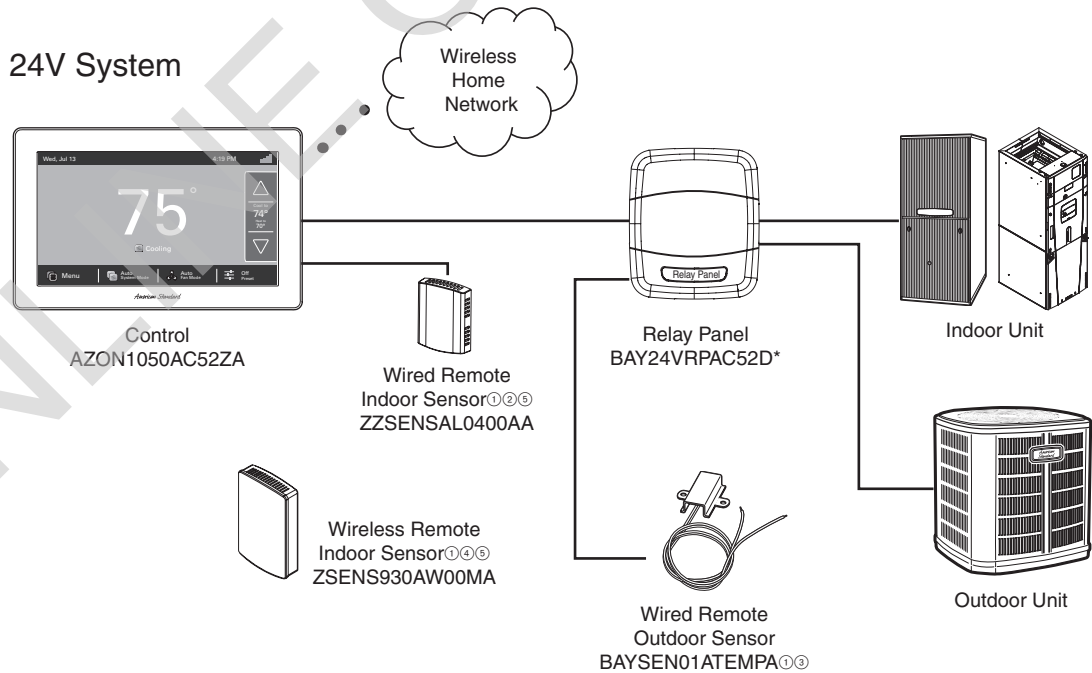

- ① Optional Accessory
- ② Can alternatively be connected to the Relay Panel
- ③ Can alternatively be connected to the 1050 Control
- ④ Z-wave sensor may be added to 1050 built in bridge
- ⑤ Use one wireless or wired sensor per zone

For complete equipment / combination selections, installation instructions and warranty information, please refer to Product Data/Ratings and/or Installers Guides and Limited Warranty Handbooks.



BUILT TO A HIGHER STANDARD®

**American Standard**®

HEATING & AIR CONDITIONING

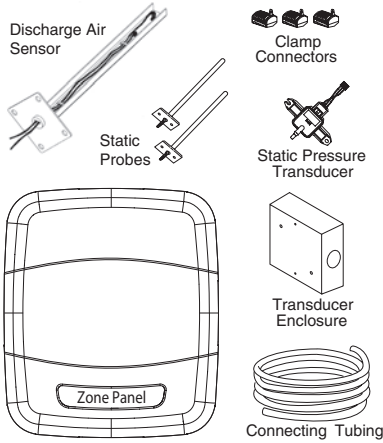

**ZZONEPNLAC52ZB**

## AccuLink™ Zoning Assembly

### ZZONEPNLAC52ZB American Standard Variable Speed Indoor Unit (Air handler/Gas Furnace) required.

#### Includes:

- Four Zone Communicating Zone Panel with discharge air sensor, static pressure transducer and housing, supply, return air static probes and connecting tubing, and three wiring blocks
- Automatically sets maximum CFM per zone
- Compatible with 24 volt systems with the addition of 24 volt relay panel
- Controls 24 volt power open, power close modulating dampers

- Auto detects installed dampers
- Supports 2-wire (ZZSENSAL0400AA) and 3-wire (AZONE940) zone sensors
- Adjustable damper motor travel times of 15 to 60 seconds
- Requires field supplied 24 volt power supply
- Up to four 1.5 VA dampers can be wired in parallel to each zone
- Backlit LCD display for easy setup and service
- Removable low voltage terminal blocks for easy service and replacement

## AccuLink™ Zone Expander Panel (Required with more than 4 zones)

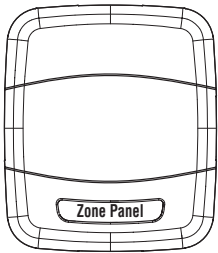

**ZZONEEXPAC52ZB**

### ZZONEEXPAC52ZA\*

- Expands the maximum number of zones per system to eight
- Controls 24 volt power open, power close modulating dampers
- Auto detects installed dampers
- Supports 2-wire (ZZSENSAL0400AA) and 3-wire (AZONE940) zone sensors
- Adjustable damper motor travel times of 15 to 60 seconds
- Requires field supplied 24 volt power supply

#### Dimensions:

- 8.0" width x 9.3" height x 1.9" depth

#### Storage Temperature:

- -40° to 175°F, 5% to 95% RH non-condensing

#### Operating Temperature:

- -40° to 150°F, 5% to 95% RH non-condensing

\*This is the same Zone Panel that ships as part of the Zoning Assembly

# AccuLink™ Zoning Component Overview

## Zoned Communicating System

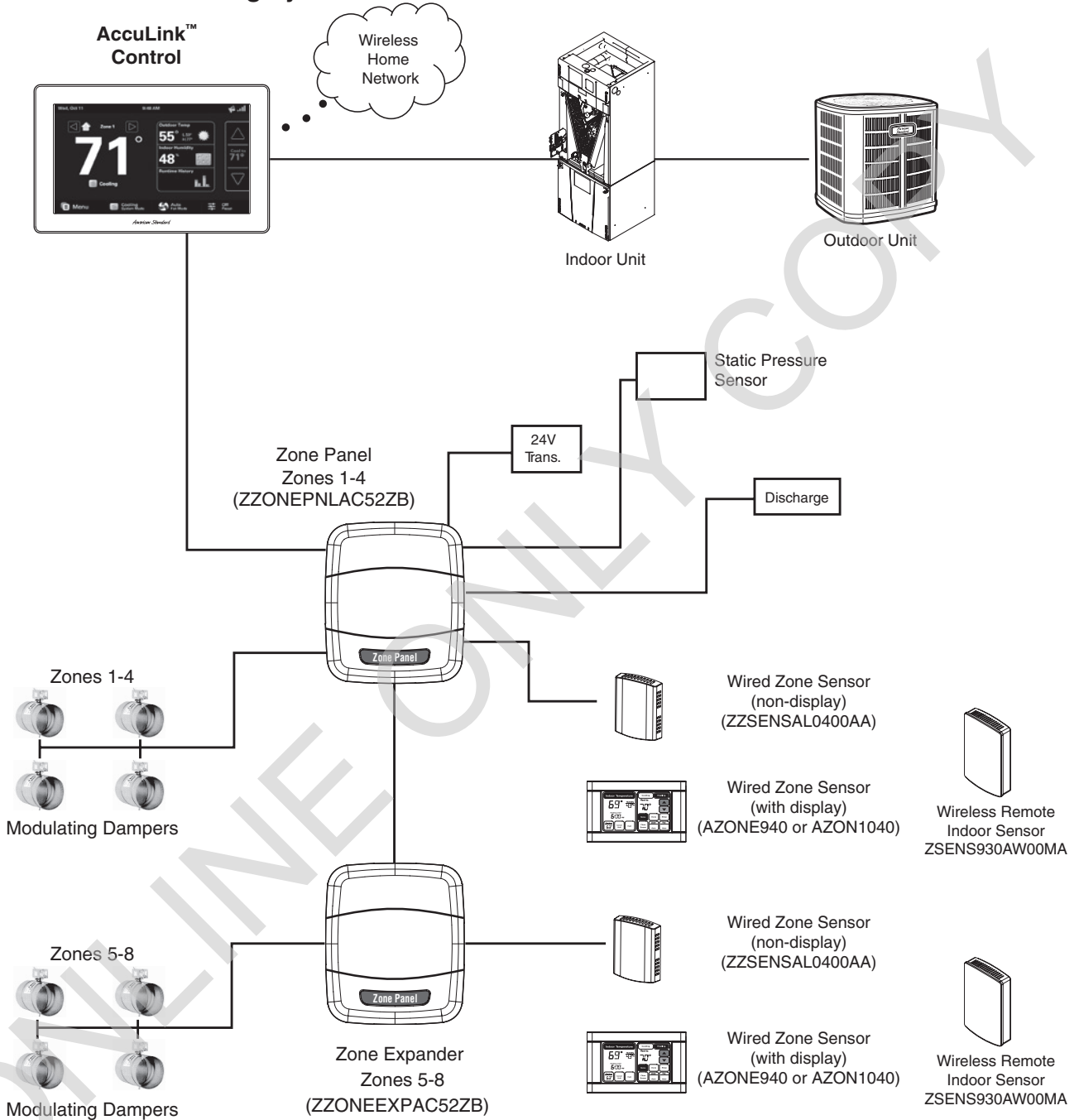

- Note 1. Each Zone Panel or Zone Expander supports up to four zones.
  - Note 2. One 940 or 1040 may be installed per zone.
  - Note 3. Up to four 0400 wired sensors or 930 wireless sensors may be installed per zone.
  - Note 4. If a 940 or 1050 is used, then up to three 0400 wired sensors or 930 wireless sensors may be installed per zone.
  - Note 5. To apply up to four sensors per zone, software version 5.4 or higher is required.]
- Example: One 940, two 930, and one 0400 may be installed per zone.

# AccuLink™ Zoning Component Overview (Cont.)

## Zoned 24V System

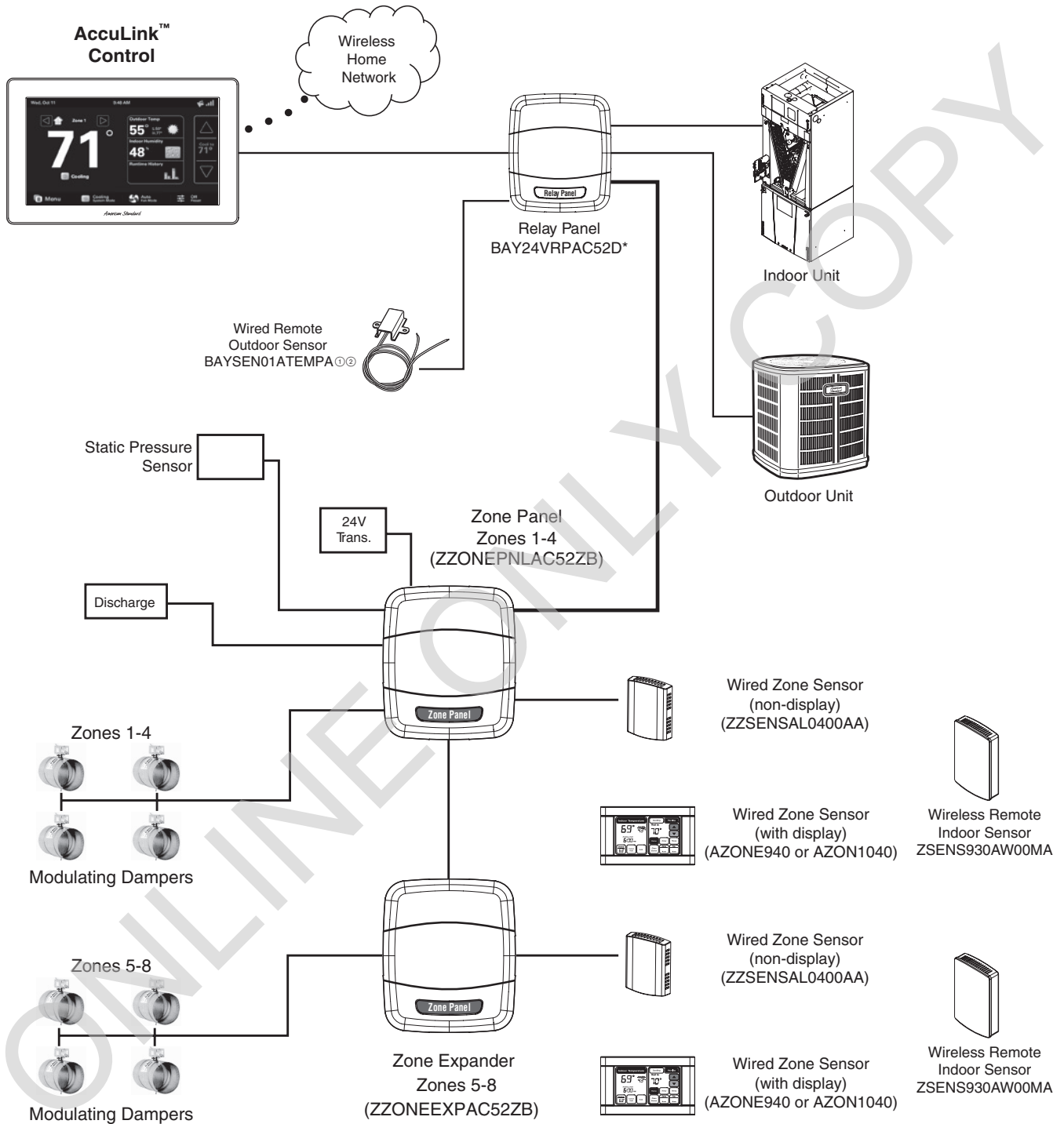

- Note 1. Each Zone Panel or Zone Expander supports up to four zones.
  - Note 2. One 940 or 1040 may be installed per zone.
  - Note 3. Up to four 0400 wired sensors or 930 wireless sensors may be installed per zone.
  - Note 4. If a 940 or 1050 is used, then up to three 0400 wired sensors or 930 wireless sensors may be installed per zone.
  - Note 5. To apply up to four sensors per zone, software version 5,4 or higher is required.]
- Example: One 940, two 930, and one 0400 may be installed per zone.

For complete equipment / combination selections, installation instructions and warranty information, please refer to Product Data/Ratings and/or Installers Guides and Limited Warranty Handbooks.

## 24 Volt Modulating Dampers

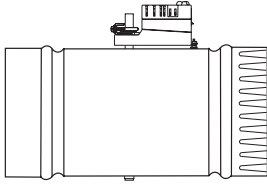

**Round Dampers**

### Round Dampers

- 24 VAC Powered open/Powered closed
- Three wire connection - 18 gauge
- 1.5 VA damper actuator with 60 second travel time
- 18 in. lbs. of torque
- Manual gear release
- Screw terminal blocks
- Flexible shutoff seal provides 98% closure

**Table CCZS-11-A — Specifications: Round Dampers**

Model Number	Power Supply	Description	Fits Round Duct Size
ZDAMPRDMA0004A	24 VAC	Round	4"
ZDAMPRDMA0006A	24 VAC	Round	6"
ZDAMPRDMA0007A	24 VAC	Round	7"
ZDAMPRDMA0008A	24 VAC	Round	8"
ZDAMPRDMA0009A	24 VAC	Round	9"
ZDAMPRDMA0010A	24 VAC	Round	10"
ZDAMPRDMA0012A	24 VAC	Round	12"
ZDAMPRDMA0014A	24 VAC	Round	14"
ZDAMPRDMA0016A	24 VAC	Round	16"
ZDAMPRDMA0018A	24 VAC	Round	18"
ZDAMPRDMA0020A	24 VAC	Round	20"

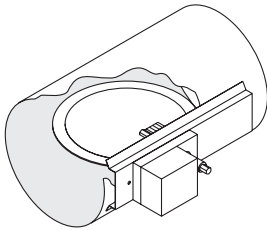

**Retro-Fit Round Dampers**

### Retro-Fit Round Dampers

- 24 VAC Powered open/Powered closed
- Three wire connection - 18 gauge
- Slip-In-Design installs quickly
- 1.5 VA damper actuator with 60 second travel time
- 18 in. lbs. of torque
- Manual gear release
- Screw terminal blocks
- Flexible shutoff seal provides 98% closure

**Table CCZS-11-B — Specifications: Retrofit Round Dampers**

Model Number	Power Supply	Description	Fits Round Duct Size
ZDAMPRRMA0004A	24 VAC	Retrofit Round	4"
ZDAMPRRMA0005A	24 VAC	Retrofit Round	5"
ZDAMPRRMA0006A	24 VAC	Retrofit Round	6"
ZDAMPRRMA0007A	24 VAC	Retrofit Round	7"
ZDAMPRRMA0008A	24 VAC	Retrofit Round	8"
ZDAMPRRMA0009A	24 VAC	Retrofit Round	9"
ZDAMPRRMA0010A	24 VAC	Retrofit Round	10"

# 24 Volt Modulating Dampers - Side Mount

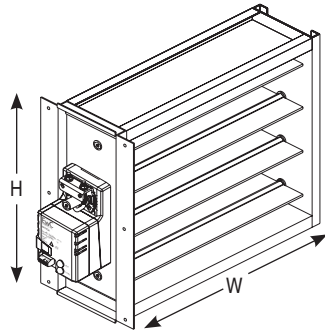

## Rectangular Dampers with Side Mount Actuator

- 24 VAC Powered open/Powered closed
- Three wire connection - 18 gauge
- 1.5 VA damper actuator with 60 second travel time
- 18 in. lbs. of torque
- Manual gear release
- Screw terminal blocks
- 97% leak proof rating
- Sturdy aluminum blades and frame
- Motor is always located on the second dimension of the model number, i.e. ZDAMP\*MMA1012A will have the motor mounted on the 12" dimension

## Rectangular Dampers with Side Mount Actuator

**Table CCZS-12-A — Specifications: Rectangular Dampers with Side Mount Actuator**

Model Number	Power Supply	Description	Uncrated Dimensions (in.)	
			W	H
ZDAMPSMMA0806A	24 VAC	Rectangular-Side Mount Actuator	8	6
ZDAMPSMMA0808A	24 VAC	Rectangular-Side Mount Actuator	8	8
ZDAMPSMMA1006A	24 VAC	Rectangular-Side Mount Actuator	10	6
ZDAMPSMMA1008A	24 VAC	Rectangular-Side Mount Actuator	10	8
ZDAMPSMMA1010A	24 VAC	Rectangular-Side Mount Actuator	10	10
ZDAMPSMMA1206A	24 VAC	Rectangular-Side Mount Actuator	12	6
ZDAMPSMMA1208A	24 VAC	Rectangular-Side Mount Actuator	12	8
ZDAMPSMMA1210A	24 VAC	Rectangular-Side Mount Actuator	12	10
ZDAMPSMMA1212A	24 VAC	Rectangular-Side Mount Actuator	12	12
ZDAMPSMMA1406A	24 VAC	Rectangular-Side Mount Actuator	14	6
ZDAMPSMMA1408A	24 VAC	Rectangular-Side Mount Actuator	14	8
ZDAMPSMMA1410A	24 VAC	Rectangular-Side Mount Actuator	14	10
ZDAMPSMMA1412A	24 VAC	Rectangular-Side Mount Actuator	14	12
ZDAMPSMMA1414A	24 VAC	Rectangular-Side Mount Actuator	14	14
ZDAMPSMMA1606A	24 VAC	Rectangular-Side Mount Actuator	16	6
ZDAMPSMMA1608A	24 VAC	Rectangular-Side Mount Actuator	16	8
ZDAMPSMMA1610A	24 VAC	Rectangular-Side Mount Actuator	16	10
ZDAMPSMMA1612A	24 VAC	Rectangular-Side Mount Actuator	16	12
ZDAMPSMMA1614A	24 VAC	Rectangular-Side Mount Actuator	16	14
ZDAMPSMMA1616A	24 VAC	Rectangular-Side Mount Actuator	16	16
ZDAMPSMMA1806A	24 VAC	Rectangular-Side Mount Actuator	18	6
ZDAMPSMMA1808A	24 VAC	Rectangular-Side Mount Actuator	18	8
ZDAMPSMMA1810A	24 VAC	Rectangular-Side Mount Actuator	18	10
ZDAMPSMMA1812A	24 VAC	Rectangular-Side Mount Actuator	18	12
ZDAMPSMMA1814A	24 VAC	Rectangular-Side Mount Actuator	18	14
ZDAMPSMMA1816A	24 VAC	Rectangular-Side Mount Actuator	18	16
ZDAMPSMMA1818A	24 VAC	Rectangular-Side Mount Actuator	18	18
ZDAMPSMMA2006A	24 VAC	Rectangular-Side Mount Actuator	20	6
ZDAMPSMMA2008A	24 VAC	Rectangular-Side Mount Actuator	20	8
ZDAMPSMMA2010A	24 VAC	Rectangular-Side Mount Actuator	20	10
ZDAMPSMMA2012A	24 VAC	Rectangular-Side Mount Actuator	20	12
ZDAMPSMMA2014A	24 VAC	Rectangular-Side Mount Actuator	20	14
ZDAMPSMMA2016A	24 VAC	Rectangular-Side Mount Actuator	20	16
ZDAMPSMMA2018A	24 VAC	Rectangular-Side Mount Actuator	20	18
ZDAMPSMMA2020A	24 VAC	Rectangular-Side Mount Actuator	20	20

# 24 Volt Modulating Dampers - Side Mount

**Table CCZS-13-A — Specifications: Rectangular Dampers with Side Mount Actuator (continued)**

Model Number	Power Supply	Description	Uncrated Dimensions (in.)	
			W	H
ZDAMPSMMA2206A	24 VAC	Rectangular-Side Mount Actuator	22	6
ZDAMPSMMA2208A	24 VAC	Rectangular-Side Mount Actuator	22	8
ZDAMPSMMA2210A	24 VAC	Rectangular-Side Mount Actuator	22	10
ZDAMPSMMA2212A	24 VAC	Rectangular-Side Mount Actuator	22	12
ZDAMPSMMA2214A	24 VAC	Rectangular-Side Mount Actuator	22	14
ZDAMPSMMA2216A	24 VAC	Rectangular-Side Mount Actuator	22	16
ZDAMPSMMA2218A	24 VAC	Rectangular-Side Mount Actuator	22	18
ZDAMPSMMA2220A	24 VAC	Rectangular-Side Mount Actuator	22	20
ZDAMPSMMA2222A	24 VAC	Rectangular-Side Mount Actuator	22	22
ZDAMPSMMA2406A	24 VAC	Rectangular-Side Mount Actuator	24	6
ZDAMPSMMA2408A	24 VAC	Rectangular-Side Mount Actuator	24	8
ZDAMPSMMA2410A	24 VAC	Rectangular-Side Mount Actuator	24	10
ZDAMPSMMA2412A	24 VAC	Rectangular-Side Mount Actuator	24	12
ZDAMPSMMA2414A	24 VAC	Rectangular-Side Mount Actuator	24	14
ZDAMPSMMA2416A	24 VAC	Rectangular-Side Mount Actuator	24	16
ZDAMPSMMA2418A	24 VAC	Rectangular-Side Mount Actuator	24	18
ZDAMPSMMA2420A	24 VAC	Rectangular-Side Mount Actuator	24	20
ZDAMPSMMA2422A	24 VAC	Rectangular-Side Mount Actuator	24	22
ZDAMPSMMA2424A	24 VAC	Rectangular-Side Mount Actuator	24	24
ZDAMPSMMA2606A	24 VAC	Rectangular-Side Mount Actuator	26	6
ZDAMPSMMA2608A	24 VAC	Rectangular-Side Mount Actuator	26	8
ZDAMPSMMA2610A	24 VAC	Rectangular-Side Mount Actuator	26	10
ZDAMPSMMA2612A	24 VAC	Rectangular-Side Mount Actuator	26	12
ZDAMPSMMA2614A	24 VAC	Rectangular-Side Mount Actuator	26	14
ZDAMPSMMA2616A	24 VAC	Rectangular-Side Mount Actuator	26	16
ZDAMPSMMA2618A	24 VAC	Rectangular-Side Mount Actuator	26	18
ZDAMPSMMA2620A	24 VAC	Rectangular-Side Mount Actuator	26	20
ZDAMPSMMA2622A	24 VAC	Rectangular-Side Mount Actuator	26	22
ZDAMPSMMA2624A	24 VAC	Rectangular-Side Mount Actuator	26	24
ZDAMPSMMA2626A	24 VAC	Rectangular-Side Mount Actuator	26	26
ZDAMPSMMA2806A	24 VAC	Rectangular-Side Mount Actuator	28	6
ZDAMPSMMA2808A	24 VAC	Rectangular-Side Mount Actuator	28	8
ZDAMPSMMA2810A	24 VAC	Rectangular-Side Mount Actuator	28	10
ZDAMPSMMA2812A	24 VAC	Rectangular-Side Mount Actuator	28	12
ZDAMPSMMA2814A	24 VAC	Rectangular-Side Mount Actuator	28	14
ZDAMPSMMA2816A	24 VAC	Rectangular-Side Mount Actuator	28	16
ZDAMPSMMA2818A	24 VAC	Rectangular-Side Mount Actuator	28	18
ZDAMPSMMA2820A	24 VAC	Rectangular-Side Mount Actuator	28	20
ZDAMPSMMA2822A	24 VAC	Rectangular-Side Mount Actuator	28	22
ZDAMPSMMA2824A	24 VAC	Rectangular-Side Mount Actuator	28	24
ZDAMPSMMA2826A	24 VAC	Rectangular-Side Mount Actuator	28	26
ZDAMPSMMA2828A	24 VAC	Rectangular-Side Mount Actuator	28	28
ZDAMPSMMA3006A	24 VAC	Rectangular-Side Mount Actuator	28	6
ZDAMPSMMA3008A	24 VAC	Rectangular-Side Mount Actuator	28	8
ZDAMPSMMA3010A	24 VAC	Rectangular-Side Mount Actuator	28	10
ZDAMPSMMA3012A	24 VAC	Rectangular-Side Mount Actuator	28	12
ZDAMPSMMA3014A	24 VAC	Rectangular-Side Mount Actuator	28	14
ZDAMPSMMA3016A	24 VAC	Rectangular-Side Mount Actuator	28	16
ZDAMPSMMA3018A	24 VAC	Rectangular-Side Mount Actuator	28	18
ZDAMPSMMA3020A	24 VAC	Rectangular-Side Mount Actuator	28	20
ZDAMPSMMA3022A	24 VAC	Rectangular-Side Mount Actuator	28	22
ZDAMPSMMA3024A	24 VAC	Rectangular-Side Mount Actuator	28	24
ZDAMPSMMA3026A	24 VAC	Rectangular-Side Mount Actuator	28	26
ZDAMPSMMA3028A	24 VAC	Rectangular-Side Mount Actuator	28	28
ZDAMPSMMA3030A	24 VAC	Rectangular-Side Mount Actuator	28	30

# 24 Volt Modulating Dampers - Bottom Mount

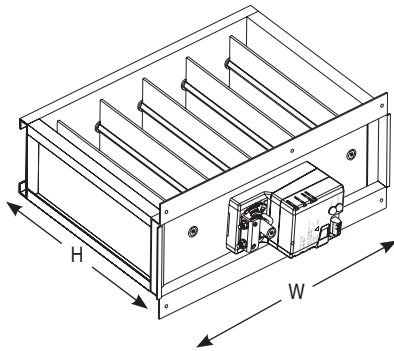

Rectangular Dampers with Bottom Mount Actuator

## Rectangular Dampers with Bottom Mount Actuator

- 24 VAC Powered open/Powered closed
- Three wire connection - 18 gauge
- 1.5 VA damper actuator with 60 second travel time
- 18 in. lbs. of torque
- Manual gear release
- Screw terminal blocks
- 97% leak proof rating
- Sturdy aluminum blades and frame
- Motor is always located on the second dimension of the model number, i.e. ZDAMP<sup>®</sup>MMA1012A will have the motor mounted on the 12" dimension

Table CCZS-14-A — Specifications: Rectangular Dampers with Bottom Mount Actuator

Model Number	Power Supply	Description	Uncrated Dimensions (in.)	
			H	W
ZDAMPBMMMA0810A	24 VAC	Rectangular-Bottom Mount Actuator	8	10
ZDAMPBMMMA0812A	24 VAC	Rectangular-Bottom Mount Actuator	8	12
ZDAMPBMMMA0814A	24 VAC	Rectangular-Bottom Mount Actuator	8	14
ZDAMPBMMMA0816A	24 VAC	Rectangular-Bottom Mount Actuator	8	16
ZDAMPBMMMA0818A	24 VAC	Rectangular-Bottom Mount Actuator	8	18
ZDAMPBMMMA0820A	24 VAC	Rectangular-Bottom Mount Actuator	8	20
ZDAMPBMMMA0822A	24 VAC	Rectangular-Bottom Mount Actuator	8	22
ZDAMPBMMMA0824A	24 VAC	Rectangular-Bottom Mount Actuator	8	24
ZDAMPBMMMA0826A	24 VAC	Rectangular-Bottom Mount Actuator	8	26
ZDAMPBMMMA0828A	24 VAC	Rectangular-Bottom Mount Actuator	8	28
ZDAMPBMMMA0830A	24 VAC	Rectangular-Bottom Mount Actuator	8	30
ZDAMPBMMMA1012A	24 VAC	Rectangular-Bottom Mount Actuator	10	12
ZDAMPBMMMA1014A	24 VAC	Rectangular-Bottom Mount Actuator	10	14
ZDAMPBMMMA1016A	24 VAC	Rectangular-Bottom Mount Actuator	10	16
ZDAMPBMMMA1018A	24 VAC	Rectangular-Bottom Mount Actuator	10	18
ZDAMPBMMMA1020A	24 VAC	Rectangular-Bottom Mount Actuator	10	20
ZDAMPBMMMA1022A	24 VAC	Rectangular-Bottom Mount Actuator	10	22
ZDAMPBMMMA1024A	24 VAC	Rectangular-Bottom Mount Actuator	10	24
ZDAMPBMMMA1026A	24 VAC	Rectangular-Bottom Mount Actuator	10	26
ZDAMPBMMMA1028A	24 VAC	Rectangular-Bottom Mount Actuator	10	28
ZDAMPBMMMA1030A	24 VAC	Rectangular-Bottom Mount Actuator	10	30
ZDAMPBMMMA1214A	24 VAC	Rectangular-Bottom Mount Actuator	12	14
ZDAMPBMMMA1216A	24 VAC	Rectangular-Bottom Mount Actuator	12	16
ZDAMPBMMMA1218A	24 VAC	Rectangular-Bottom Mount Actuator	12	18
ZDAMPBMMMA1220A	24 VAC	Rectangular-Bottom Mount Actuator	12	20
ZDAMPBMMMA1222A	24 VAC	Rectangular-Bottom Mount Actuator	12	22
ZDAMPBMMMA1224A	24 VAC	Rectangular-Bottom Mount Actuator	12	24
ZDAMPBMMMA1226A	24 VAC	Rectangular-Bottom Mount Actuator	12	26
ZDAMPBMMMA1228A	24 VAC	Rectangular-Bottom Mount Actuator	12	28
ZDAMPBMMMA1230A	24 VAC	Rectangular-Bottom Mount Actuator	12	30
ZDAMPBMMMA1416A	24 VAC	Rectangular-Bottom Mount Actuator	14	16
ZDAMPBMMMA1418A	24 VAC	Rectangular-Bottom Mount Actuator	14	18
ZDAMPBMMMA1420A	24 VAC	Rectangular-Bottom Mount Actuator	14	20
ZDAMPBMMMA1422A	24 VAC	Rectangular-Bottom Mount Actuator	14	22
ZDAMPBMMMA1424A	24 VAC	Rectangular-Bottom Mount Actuator	14	24
ZDAMPBMMMA1426A	24 VAC	Rectangular-Bottom Mount Actuator	14	26
ZDAMPBMMMA1428A	24 VAC	Rectangular-Bottom Mount Actuator	14	28
ZDAMPBMMMA1430A	24 VAC	Rectangular-Bottom Mount Actuator	14	30
ZDAMPBMMMA1618A	24 VAC	Rectangular-Bottom Mount Actuator	16	18
ZDAMPBMMMA1620A	24 VAC	Rectangular-Bottom Mount Actuator	16	20
ZDAMPBMMMA1622A	24 VAC	Rectangular-Bottom Mount Actuator	16	22
ZDAMPBMMMA1624A	24 VAC	Rectangular-Bottom Mount Actuator	16	24
ZDAMPBMMMA1626A	24 VAC	Rectangular-Bottom Mount Actuator	16	26
ZDAMPBMMMA1628A	24 VAC	Rectangular-Bottom Mount Actuator	16	28
ZDAMPBMMMA1630A	24 VAC	Rectangular-Bottom Mount Actuator	16	30
ZDAMPBMMMA1820A	24 VAC	Rectangular-Bottom Mount Actuator	18	20
ZDAMPBMMMA1822A	24 VAC	Rectangular-Bottom Mount Actuator	18	22
ZDAMPBMMMA1824A	24 VAC	Rectangular-Bottom Mount Actuator	18	24
ZDAMPBMMMA1826A	24 VAC	Rectangular-Bottom Mount Actuator	18	26
ZDAMPBMMMA2022A	24 VAC	Rectangular-Bottom Mount Actuator	20	22
ZDAMPBMMMA2024A	24 VAC	Rectangular-Bottom Mount Actuator	20	24

BUILT TO A HIGHER STANDARD

*American Standard*

HEATING & AIR CONDITIONING

# 24 Volt Modulating Dampers

Table CCZS-15-A — Rectangular Damper Net Free Area

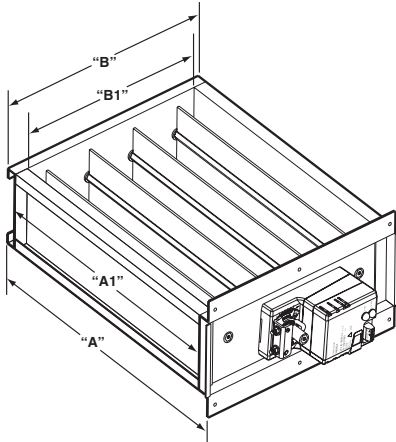

Listed Size	Actual Outside Size	Actual Inside Size	8	10	12	14	16	18	20	22	24	26	28	30	Listed Size	High
			7.813	9.813	11.813	13.813	15.813	17.813	19.813	21.813	23.813	25.813	27.813	29.813	Act. Outside Size B	
Wide	A	A1	5.813	7.813	9.813	11.813	13.813	15.813	17.813	19.813	21.813	23.813	25.813	27.813	Act. Inside Size B1	
			3	3	4	5	6	7	7	8	9	10	11	11	No. of Blades	
6	5.812	4.313	19.5	28.1	34.9	41.6	48.6	55.1	63.8	70.5	77.3	84.0	90.8	99.4		
8	7.812	6.313	28.5	41.1	51.0	60.9	70.8	80.7	93.3	103.2	113.1	123.0	132.9	145.5		
10	9.812	8.313	37.5	54.2	67.2	80.2	93.2	106.3	122.9	135.9	148.9	162.0	175.0	191.6		
12	11.812	10.313	46.5	67.2	83.3	99.5	115.7	131.8	152.5	168.6	184.8	200.9	217.1	237.7		
14	13.812	12.313	55.6	80.2	99.5	118.8	138.1	157.4	182.0	201.3	220.6	239.9	259.2	283.8		
16	15.812	14.313	64.6	93.2	115.7	138.1	160.5	183.0	211.6	234.0	256.4	278.9	301.3	329.9		
18	17.812	16.313	73.6	106.3	131.8	157.4	183.0	208.5	241.1	266.7	292.3	317.8	343.4	376.0		
20	19.812	18.313	82.7	119.3	148.0	176.7	205.4	234.1	270.7	299.4	328.1	356.8	385.5	422.1		
22	21.812	20.313	91.7	132.3	164.2	196.0	227.8	259.6	300.3	332.1	363.9	395.8	427.6	468.2		
24	23.812	22.313	100.7	145.4	180.3	215.3	250.2	285.2	329.8	364.8	399.8	435.2	469.7	514.3		
26	25.812	24.313	109.8	158.4	196.5	234.6	272.7	310.8	359.4	397.5	435.6	473.7	511.8	560.4		
28	27.812	26.313	118.8	171.4	212.6	253.9	295.1	336.3	389.0	430.2	471.4	512.7	553.8	606.5		
30	29.812	28.313	127.8	184.4	228.8	273.2	317.5	361.9	418.5	462.9	507.3	551.6	596.0	652.6		

For complete equipment / combination selections, installation instructions and warranty information, please refer to Product Data/Ratings and/or Installers Guides and Limited Warranty Handbooks.

CCZS-15

Effective 1/1/22  
14-1011-39

Smart Thermostats / Zone Sensors



# Programmable Touchscreen Thermostats

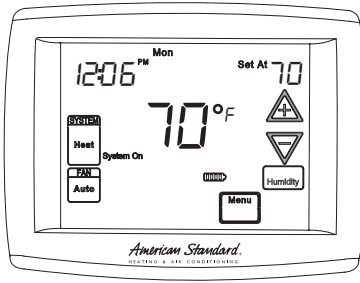

**ACONT303AS42DA**

### ACONT303AS42DA

- 5" Diagonal Touchscreen
- Built-in Humidity sensor
- Programmable: 7 day, 5/1/1 day, or none
- Common preferred, not required with 2AA battery power (included)
- Simple to install and use
- 5" diagonal touchscreen
- Remote wired indoor or outdoor sensor option
- Control with one indoor sensor or average with thermostat internal sensor
- Armchair Programming (requires batteries)
- Cooling dehumidification (DHM) (normally closed relay; opens, 24V to BK)
- Humidifier Relay (HM)

### Application:

- Up to 4 Heat/2 Cool (Gas, Oil or Electric) / HP / Dual Fuel
- ZZSENSAL0300AA - Remote Indoor Temperature Sensor
- BAYSEN30ATEMPA - Remote Outdoor Temperature Sensor

### Dimensions:

- 4.56" h x 5.81" h x 1.18" d
- Finish: Bright White

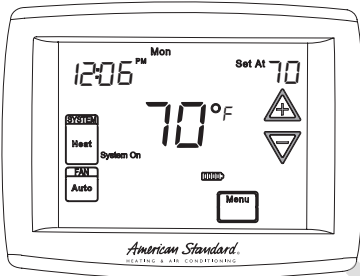

**ACONT302AS42DA**

### ACONT302AS42DA

- 5" Diagonal Touchscreen
- Programmable: 7 day, 5/1/1 day, or none
- Common preferred, not required with 2AA battery power (included)
- Simple to install and use
- 5" diagonal touchscreen
- Remote wired indoor or outdoor sensor option
- Control with one indoor sensor or average with thermostat internal sensor
- Armchair Programming (requires batteries)

### Application:

- Up to 4 Heat/2 Cool (Gas, Oil or Electric) / HP / Dual Fuel
- ZZSENSAL0300AA - Remote Indoor Temperature Sensor
- BAYSEN30ATEMPA - Remote Outdoor Temperature Sensor

### Dimensions:

- 4.56" h x 5.81" h x 1.18" d
- Finish: Bright White

BUILT TO A HIGHER STANDARD

**American Standard**  
HEATING & AIR CONDITIONING

## Programmable Thermostats

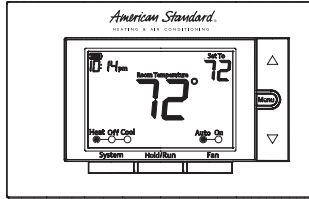

**ACONT203AS42MA**

### ACONT203AS42MA

#### 4 Heat/2 Cool

- 5/1/1 or 7 day Programming
- Simple to Install and Use
- 3.5" Diagonal, Backlit Display
- Common preferred, not required with 2AA battery power (included)
- Easy to follow Sequential Programming
- Indoor and setpoint temperatures displayed simultaneously
- Easy battery access
- Easy to understand soft key controls

#### Application:

- Up to 4 Heat/2 Cool (Gas, Oil or Electric) / HP / Dual Fuel (non-restricted mode only)

#### Dimensions:

- 3.75" h x 6.0" w x 1.12" d
- Finish: Bright White

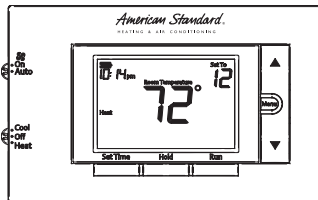

**ACONT202AS11MA**

### ACONT202AS11MA

#### 1 Heat/1 Cool

- 5/1/1 or 7 day Programming
- Simple to Install and Use
- 3.5" Diagonal, Backlit Display
- Common preferred, not required with 2AA battery power (included)
- Standard Wiring Terminal Block
- Easy to follow Sequential Programming
- Indoor and setpoint temperatures displayed simultaneously
- No auxiliary heat capability
- Easy battery access
- Easy to understand soft key controls

#### Application:

- 1 Heat/1 Cool

#### Dimensions:

- 3.75" h x 6.0" w x 1.12" d
- Finish: Bright White

BUILT TO A HIGHER STANDARD<sup>®</sup>

*American Standard*<sup>®</sup>

HEATING & AIR CONDITIONING

## Non-Programmable Comfort Controls

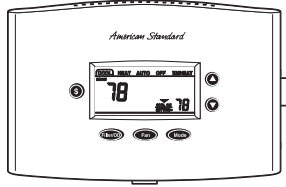

**ACONT402A**

### **ACONT402AN32DA**

Auto Changeover  
Backlit Display & Keys  
Comfort Information Compartment  
Energy Savings Mode  
Filter Reminder  
BAYSEN01ATEMPAA-Outdoor  
Temperature Sensor included\*  
Keypad Lock

**Application** (3-9 Wire Hookup -2  
for Outdoor Sensor) Heat Pump\*  
or A/C

3 Heat/2 Cool

No external Dual Fuel Kit Required

Do not use with TAYPLUS103A

ZZSENSAL0400AA - Remote Indoor  
Temperature Sensor

### **Dimensions:**

6.75" w x 4.52" h x 1.20" d

Finish: Bright White

\* Requires external relay for oil furnace  
applications.

\* Installation is required for outdoor  
temperature sensing and display

BUILT TO A HIGHER STANDARD

*American Standard*  
HEATING & AIR CONDITIONING

## Non-Programmable Thermostats

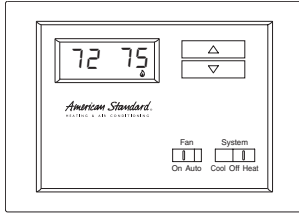

**ACONT103A**

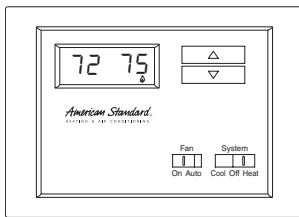

**ACONT102A**

### ACONT103AN21MA

#### 2 Heat/1 Cool

- Push Button, Non-Programmable
- 1.9" Diagonal Display
- Configurable Switchover Valve
- Emergency Heat
- Common required
- Fahrenheit or Celsius
- Keypad Lock

#### Application

- Up to 2 Heat/1Cool (**HP only**)
- 1 Stage Compressor
- 1 Stage Auxiliary Heat

#### Dimensions:

- 3.88" h x 5.5" h x 1.18" d
- Finish: Bright White

### ACONT102AN11AA

#### 1 Heat/1 Cool

- Push Button, Non-Programmable
- 1.9" Diagonal Display
- No Common Terminal
- Battery Powered Only (Batteries included)
- RH / RC Jumper
- Fahrenheit or Celsius

#### Application

- Up to 1Heat/1 Cool (Gas, Oil or Electric)
- Finish: Bright White

#### Dimensions:

- 3.88" h x 5.5" h x 1.18" d
- Finish: Bright White

## Remote Sensors



### BAYSEN02ATEMPA

- Outdoor Temperature Sensor for use with ACONT800, 802, 803
- Accuracy +/- 1°F from -40 to 120°F

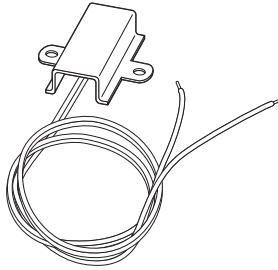

### BAYSEN01ATEMPA

- Outdoor Temperature Sensor for use with AZON1050AC, AZONE950AC, ACONT850AC, ACONT824AS, ACONT624AS, ACONT402AN, ACONT401AN, BAY24VRPAC52D\*.
- Accuracy
  - +/- 1.5°F over 32°F to 100°F
- Display Range
  - -40°F to 140°F

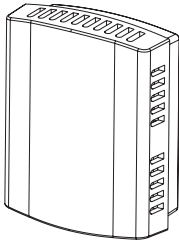

### ZZSENSAL0400AA

- Indoor Wired Sensor for use with AZON1050AC, AZONE950AC, ACONT850AC, ACONT824AS, ACONT624AS, ACONT402AN, BAY24VRPAC52D\*.
- Operating Ambient Temperature Range: 20° to 120°F (-6.7° to 48.9°C)
- Display Range: 20° to 120°F (-6.7° to 48.9°C)
- Sensor Accuracy: +/- .5°F at 75°F
- Operating Relative Humidity: 5% to 90% non-condensing

#### Dimensions in in. (mm):

- 1.54 (39)w x 1.93 (49)h x .625 (1.6)d
- Storage Temperature: -40° to 140°F (-40° to 60°C)
- Finish: White

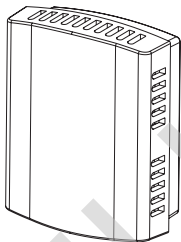

### ZZSENSAL0800AA

- Indoor Wired Temperature Sensor for use with ACONT800, ACONT802, ACONT803
- Operating Ambient Temperature Range: 20° to 120°F (-6.7° to 48.9°C)
- Display Range: 0 to 99°F (-18 to 37°C)
- Sensor Accuracy: +/-1.5°F at 70°F (+/- .84 at 21°C)
- Operating Relative Humidity: 5% to 95% non-condensing

#### Dimensions in in. (mm):

- 1.54 (39)w x 1.93 (49)h x .625 (16)d
- Storage Temperature: -40° to 140°F (-40° to 60°C)
- Finish: White

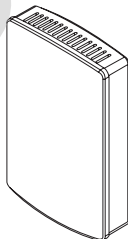

### ZSENS930AW00MA

- Indoor Wireless Temperature and Humidity Sensor for use with ACONT824, ACONT850, AZON1050
- Operating Ambient Temperature Range: 32° to 104°F (0° to 40°C)
- Power Supply: Two AAA alkaline batteries
- Sensor Accuracy: +/-1°F over the sensing range of 32°F to 120°F (0° to 48.9°C)
- Operating Relative Humidity: 10% to 90% non-condensing

#### Dimensions in in. (mm):

- 2.0" (51)w x 3.25" (83)h x .6 (15)d
- Storage Temperature: -40° to 140°F (-40° to 65°C)
- Finish: White

For complete equipment / combination selections, installation instructions and warranty information, please refer to Product Data/Ratings and/or Installers Guides and Limited Warranty Handbooks.

# Outdoor Thermostat Kit

## TAYSTAT250B

- The outdoor thermostat (ODT) is designed to turn "ON" the supplementary heater at a pre-selected outdoor temperature.
- The number and setting of the ODT is dependent on the heat loss of the structure and capacity of the heating system installed.
- This model ODT gives a temperature range for 44°F. to -10°F. (See figure 1 for settings). The switching action is single pole/double throw, opening on temperature rise and closing on temperature fall, completing the circuit through the thermostat.

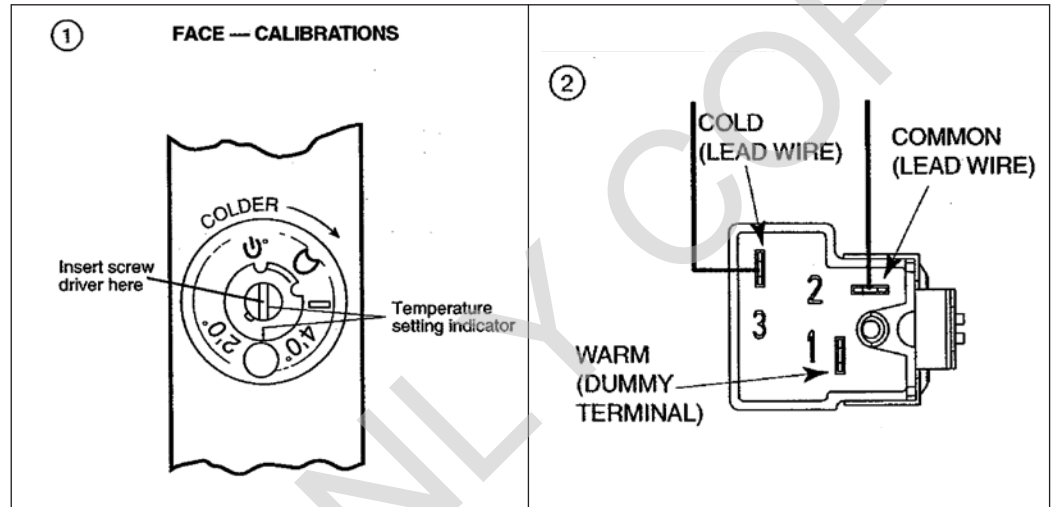

# Packaged Cooling Convertible 2-5 Tons

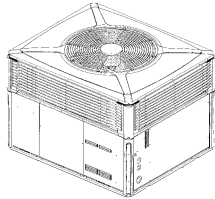

**4TCY5**

**Table PK-1-A — 4TCY5 - Gold 15 - Convertible Packaged Cooling - R-410A**

Model Number	Cooling Capacity (BTUH)	SEER/EER	Shipping Weight	MCA	Max Fuse	Sound Rating	Uncrated Dimensions (in.) H x D x W
<b>4TCY5 – 208-230/1/60</b>							
4TCY5024A1000A	23,800	15.00/12.00	388	18.4	25	65	36 x 42 x 49
4TCY5030A1000A	28,400	15.00/12.00	418	21.2	30	70	38 x 42 x 49
4TCY5036A1000A	36,000	15.00/12.00	422	23.8	35	69	38 x 42 x 49
4TCY5042A1000A	40,500	15.00/12.00	547	28.6	45	71	38 x 45 x 59
4TCY5048A1000A	48,000	15.00/12.00	570	34.2	50	71	42 x 45 x 59
4TCY5060A1000A	57,500	15.00/11.40	582	44.4	60	73	42 x 45 x 59

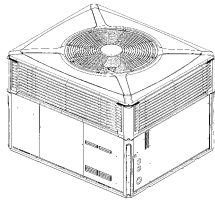

**4TCY4  
 (3-phase only)**

**Table PK-1-B — 4TCY4 - Gold 14 - Convertible Packaged Cooling - R-410A**

Model Number	Cooling Capacity (BTUH)	SEER/EER	Shipping Weight	MCA	Max Fuse	Sound Rating	Uncrated Dimensions (in.) H x D x W
<b>4TCY4 – 208-230/3/60</b>							
4TCY4036B3000A	38,000	14.20/12.00	450	19.8	30	69	38 x 42 x 49
4TCY4048B3000A	48,000	14.30/11.90	607	26.4	40	72	38 x 45 x 59
4TCY4060A3000B	60,000	14.30/12.00	612	30.6	45	76	42 x 45 x 59

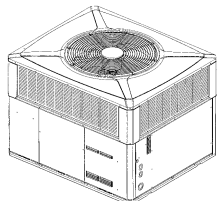

**4TCC4**

**Table PK-1-C— 4TCC4 - Silver 14 - Convertible Packaged Cooling - R-410A**

Model Number	Cooling Capacity (BTUH)	SEER/EER	Shipping Weight	MCA	Max Fuse	Sound Rating	Uncrated Dimensions (in.) H x D x W
<b>4TCC4 – 208-230/1/60</b>							
4TCC4024A1000A	24,600	14.00/12.00	432	19.1	30	67	36 x 42 x 49
4TCC4030A1000A	28,200	14.00/12.00	451	22.6	35	69	36 x 42 x 49
4TCC4036A1000A	37,000	14.00/12.00	453	24.5	40	69	38 x 42 x 49
4TCC4042A1000A	40,500	14.00/12.00	561	28.5	45	75	36 x 45 x 59
4TCC4048A1000A	46,500	14.00/11.50	557	32.0	50	73	40 x 45 x 59
4TCC4060A1000A	58,000	14.00/11.50	586	39.1	60	73	40 x 45 x 59

**For dimensional/outline drawings, please refer to Product Data.  
 For information on Roof Curbs, please refer to the Accessories/Information Tab.**

For complete equipment / combination selections, installation instructions and warranty information, please refer to Product Data/Ratings and/or Installers Guides and Limited Warranty Handbooks.

BUILT TO A HIGHER STANDARD<sup>®</sup>

**American Standard**<sup>®</sup>  
HEATING & AIR CONDITIONING

# Packaged Cooling Convertible 2-5 Tons

**Table PK-2-A — Feature**

	4TCY5 2-5	4TCY4 3-5	4TCC4 2-5
• SEER up to .....	15.00	14.25	14.00
• Exclusive <b>Duration</b> <sup>™</sup> high efficiency compressor with internal overload protection.....	✓	✓	✓
• Factory supplied charge.....	R-410A	R-410A	R-410A
• Composite <b>Vortica</b> <sup>®</sup> indoor blower .....	✓	✓	✓
• Direct drive, variable speed ECM blower motor **.....	✓	✓	—
• Direct drive, multi-speed ECM blower motor (high efficiency)*.....	—	—	✓
• All aluminum <b>Spine Fin</b> <sup>™</sup> outdoor coil .....	✓	✓	✓
• Swept-blade outdoor fan for quiet operation .....	✓	✓	✓
• Architecturally integrated louvers and corner guards.....	✓	✓	—
• All steel louvers .....	—	—	✓
• Polyslate gray cabinet .....	✓	✓	✓
• Single stage cooling .....	2-3½	✓	✓
• Two stage cooling.....	4, 5	—	—
• High pressure cutout.....	✓	✓	✓
• Low pressure cutout.....	✓	✓	✓
• Liquid line drier - factory installed .....	✓	✓	✓
• Non-bleed expansion valves on indoor coil.....	✓	✓	✓
• Pressure taps, including liquid line taps, easily accessed and protected inside compressor compartment .....	✓	✓	✓
• Right side electrical service access for high and low voltage connections.....	✓	✓	✓
• Rugged steel basepan features deep drawn duct connections .....	✓	✓	✓
• Steeply sloped composite drainpan .....	✓	✓	✓
• Ships in horizontal configuration and converts quickly for downflow .....	✓	✓	✓
• Copper tube, aluminum fin indoor coil .....	3,4,& 5	✓	5
• All aluminum indoor coil .....	2, 2½, 3½	—	2-4
• All models are certified to UL 1995.....	✓	✓	✓
• <b>10-year compressor, 10-year coils &amp; all other functional parts limited warranty with registration<sup>†</sup> (Residential use)</b> .....	✓	✓	✓
• <b>Extended warranties available</b> .....	✓	✓	✓

\* Constant torque ECM (electronically commutated motor).

\*\* Constant airflow ECM (electronically commutated motor).

<sup>†</sup> Registered Limited Warranty terms are available when you register within 60 days of installation. You can register online at americanstandardair.com or by phone at 855-260-2975, otherwise American Standard Heating & Air Conditioning's Base Limited Warranty terms will apply. Base Limited Warranty information on specific products can be found on americanstandardair.com. Ask your dealer for full warranty information at time of purchase. Warranties are for residential and multi-family use only, some exclusions may apply.

**For dimensional/outline drawings, please refer to Product Data.  
For information on Roof Curbs, please refer to the Accessories/Information Tab.**

For complete equipment / combination selections, installation instructions and warranty information, please refer to Product Data/Ratings and/or Installers Guides and Limited Warranty Handbooks.



# Packaged Cooling Convertible 2-5 Tons

**Table PK-3-A — Accessories**

Model Number	Description	Shipping Weight	4TCY5 2-5	4TCY4 3-5	4TCC4 2-5
BAYACCDOR1A	Hinged Filter Access Door <sup>11</sup>		2-3	2-3	2-3
BAYACCDOR2A	Hinged Filter Access Door <sup>11</sup>		3½-5	3½-5	3½-5
BAYACCEADP1A	Adaptor Kit for Installation of <b>AccuClean™</b> and 5" Media Filter (Horizontal) <sup>9</sup>	10	2-3	3	2-3
BAYACCEADP2A	Adaptor Kit for Installation of <b>AccuClean™</b> and 5" Media Filter (Horizontal) <sup>9</sup>	12	3½-5	3½-5	3½-5
BAYADAP050A	Adapter Curb (Cabinet A/B)		2-3	2-3	2-3
BAYADAP051A	Adapter Curb (Cabinet C)		2-3	2-3	2-3
BAYADAP052A	Adapter Curb (Cabinet A/B)		3½-5	3½-5	3½-5
BAYADAP053A	Adapter Curb (Cabinet C)		3½-5	3½-5	3½-5
BAYADAP054A	Adapter Curb (Cabinet D)		3½-5	3½-5	3½-5
BAYASCT001	Anti-Short Cycle Timer <sup>4</sup>		✓	✓	—
BAYCCHT102A	Crankcase Heater (230V) (Scroll)		3½-5	3½-5	3½-5
BAYCCHT103A	Crankcase Heater (230V) (Scroll)		2-3	3	2-3
BAYCOVR112A	12" Duct Shroud (Covers Horizontal Ducts) <sup>5</sup>		2-5	2-5	2-5
BAYCOVR118A	18" Duct Shroud (Covers Horizontal Ducts) <sup>5</sup>		2-5	2-5	2-5
BAYCURB050A	Flat Roof Full Perimeter Curb (Insulated)	74	2-3	3	2-3
BAYCURB051A	Flat Roof Full Perimeter Curb (Insulated)	74	3½-5	3½-5	3½-5
BAYDMPR101A	2-Position Motorized Fresh Air Damper <sup>1 6 7 8 9</sup>		2-3	2-3	2-3
BAYDMPR102A	2-Position Motorized Fresh Air Damper <sup>1 6 7 8 9</sup>		3½-5	3½-5	3½-5
BAYECON101A	Economizer with Barometric Relief (Downflow) <sup>1 2 3 4 9 10</sup>	50	2-3	2-3	2-3
BAYECON102A	Economizer with Barometric Relief (Downflow) <sup>1 2 3 4 9 10</sup>	65	3½-5	3½-5	3½-5
BAYECON104AB	Economizer with Barometric Relief (Downflow) <sup>1 2 3 4 9 10</sup>	65	4-5	—	—
BAYECON200A	Economizer (Horizontal) <sup>1 2 3 6</sup>	85	2-3	2-3	2-3
BAYECON201A	Economizer (Horizontal) <sup>1 2 3 6</sup>	85	3½	3½-5	3½-5
BAYECON204A	Economizer (Horizontal) <sup>1 2 3 6</sup>	85	4-5	—	—
BAYENTH001A	Enthalpy Control Kit <sup>2</sup>	2	✓	✓	✓
BAYEXMK001A	Extreme Conditions Mounting Kit (Used on BAYCURB & BAYADAP)		✓	✓	✓
BAYEXMK002B	Extreme Conditions Mounting Kit (Used on BAYUTIL)		✓	✓	✓
BAYEXMK003A	Extreme Conditions Mounting Kit (Used on Slab Mounts)		✓	✓	✓
BAYFLTR101C	1-2" Filter Frame (requires one 18x25 filter which is not included) <sup>1</sup>	6	2-3	2-3	2-3
BAYFLTR201C	1-2" Filter Frame (requires one 18x20 and one 18x18 filter which are not included) <sup>1 2</sup>	6	3½-5	3½-5	3½-5
BAYLIFT002B	Lifting Lug Kit	5	✓	✓	✓
BAYLOAM011A	Evaporator Defrost Control Kit		✓	✓	✓
BAYLOAM105A	Low Ambient Control Kit	5	✓	✓	✓
BAYOSAH001A	Manual Fresh Air Damper <sup>1</sup>	6	2-3	2-3	2-3
BAYOSAH002A	Manual Fresh Air Damper <sup>1</sup>	8	3½-5	3½-5	3½-5
BAYQSTK300A	Start Kit (not factory installed)		✓	—	✓
BAYSQRD001B	16" Round Duct Adapter <sup>10</sup>	5	2-3	2-3	2-3
BAYSQRD002B	18" Round Duct Adapter <sup>10</sup>	3	2-5	2-5	2-5
BAYUTIL101B	Roof Curb Utility Extension Kit		2-3	2-3	2-3
BAYUTIL102B	Roof Curb Utility Extension Kit		3½-5	3½-5	3½-5

- ① Must use filter frame when economizer/fresh air kit is used.
- ② Dry bulb control standard with economizer.
- ③ 2-Stage cooling control required when using economizer.
- ④ Do not use with electronic thermostats.
- ⑤ BAYCOVR112,118A will not cover BAYSQRD002B applications.
- ⑥ Does not contain barometric relief.
- ⑦ Max fresh air - 25%.
- ⑧ For non-continuous fan gas-heating applications, the damper opens only when the OD ambient is above 50° F.
- ⑨ It is the designer/engineer/installer's responsibility to review product specifications and technical literature to insure optimal performance and compliance to codes.
- ⑩ Temperature of mixed air entering the heat exchanger is monitored and fresh air intake may be reduced under certain conditions.
- ⑪ BAYACCDOR1A requires BAYFLTR101B & BAYACCDOR2A requires BAYFLTR201B. They are not backward compatible to BAYFLTR101/201A.
- ⑫ When using a BAYACCDOR2A, two 18x20 filters are required.

EXISTING CURB	NEW UNIT 4TCY4/5	USE BAYADAP0**A
BAYCURB030,38A	024-036	50
BAYCURB030,38A	042-060	52
BAYCURB033A	024-036	51
BAYCURB033A	042-060	53
BAYCURB034A	042-060	54

**For dimensional/outline drawings, please refer to Product Data.  
 For information on Roof Curbs, please refer to the Accessories/Information Tab.**

For complete equipment / combination selections, installation instructions and warranty information, please refer to Product Data/Ratings and/or Installers Guides and Limited Warranty Handbooks.

BUILT TO A HIGHER STANDARD<sup>®</sup>*American Standard*<sup>®</sup>

HEATING &amp; AIR CONDITIONING

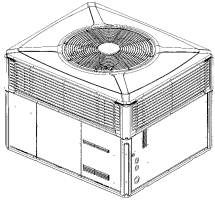
**Packaged Hybrid/Dual Fuel  
Convertible 2-5 Tons****4DCZ6****Table PK-4-A — 4DCZ6 - Platinum 16 - Convertible Packaged Dual Fuel - R-410A**

Model Number	Cooling Capacity (BTUH)	Gas Capacity Heating Output (1 Stg./2 Stg.)	SEER/EER	HSPF	AFUE(%)	Shipping Weight	MCA	Max Fuse	Sound Rating	Uncrated Dimensions (in.) H x D x W
<b>4DCZ6 – 208-230/1/60</b>										
4DCZ6036C1070A	36,000	45,000/57,000	16.00/12.20	8.30	81.0	488	24.3	35	70	38 x 42 x 49
4DCZ6048C1090A	47,500	58,000/73,000	16.00/12.00	8.50	81.0	665	34.2	50	72	42 x 45 x 59
4DCZ6060C1115A	57,000	75,000/93,000	15.00/11.50	8.30	81.0	676	42.0	60	74	42 x 45 x 59
<b>4DCZ6 – 208-230/3/60</b>										
4DCZ6036B3075A	36,000	48,400/60,000	16.00/12.20	8.30	79.5	488	19.7	30	70	38 x 42 x 49
4DCZ6048B3096A	47,500	62,000/77,000	16.00/12.00	8.50	80.0	665	25.2	35	72	42 x 45 x 59
4DCZ6060B3120A	57,000	77,500/96,000	15.00/11.50	8.30	80.0	676	30.0	45	74	42 x 45 x 59

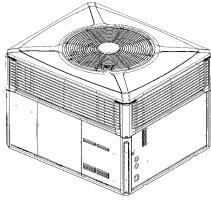
**4DCY4****Table PK-4-B — 4DCY4 - Gold 14 - Convertible Packaged Dual Fuel - R-410A**

Model Number	Cooling Capacity (BTUH)	Gas Capacity Heating Output (1 Stg./2 Stg.)	SEER/EER	HSPF	AFUE(%)	Shipping Weight	MCA	Max Fuse	Sound Rating	Uncrated Dimensions (in.) H x D x W
<b>4DCY4 – 208-230/1/60</b>										
4DCY4024D1060A	23,600	39,000/49,000	14.00/12.00	8.00	81.0	481	16.1	25	68	36 x 42 x 49
4DCY4030D1070A	30,000	45,000/57,000	14.25/12.00	8.00	81.0	481	19.1	30	76	38 x 42 x 49
4DCY4036C1070A	37,000	45,000/57,000	14.00/12.00	8.00	81.0	488	26.2	40	69	38 x 42 x 49
4DCY4042C1090A	42,000	58,000/73,000	14.00/12.00	8.00	81.0	653	30.8	45	74	38 x 45 x 59
4DCY4048C1090A	47,500	58,000/73,000	14.00/12.00	8.00	81.0	653	35.5	50	73	42 x 45 x 59
4DCY4060C1115A	58,000	75,000/93,000	14.00/12.00	8.00	81.0	676	39.9	60	76	42 x 45 x 59
<b>4DCY4 – 208-230/3/60</b>										
4DCY4036B3075A	36,000	48,400/60,000	14.00/11.40	8.00	79.5	488	19.8	30	69	38 x 42 x 49
4DCY4048A3096C	47,000	62,000/77,000	14.30/10.85	8.00	80.0	653	26.4	40	73	42 x 45 x 59
4DCY4060A3120C	57,500	77,500/96,000	14.00/11.50	8.00	80.0	676	30.6	60	76	42 x 45 x 59

**For dimensional/outline drawings, please refer to Product Data.****For information on Roof Curbs, please refer to the Accessories/Information Tab.**

For complete equipment / combination selections, installation instructions and warranty information, please refer to Product Data/Ratings and/or Installers Guides and Limited Warranty Handbooks.

# Packaged Hybrid/Dual Fuel Convertible 2-5 Tons

Table PK-5-A — Features	4DCZ6 3-5	4DCY4 2-5
• SEER up to.....	16.00	14.25
• HSPF up to.....	8.50	8.00
• Exclusive <b>Duration™</b> high efficiency compressor with internal overload protection.....	✓	✓
• Factory supplied charge.....	R-410A	R-410A
• Composite <b>Vortica®</b> indoor blower.....	✓	✓
• Direct drive, variable speed ECM blower motor **.....	✓	✓
• All aluminum <b>Spine Fin™</b> outdoor coil.....	✓	✓
• Swept-blade outdoor fan for quiet operation.....	✓	✓
• Architecturally integrated louvers and corner guards.....	✓	✓
• Polyslate gray cabinet.....	✓	✓
• Stainless steel heat exchanger and burners.....	✓	✓
• Single stage heating & cooling.....	—	✓
• Two stage heating & cooling.....	✓	—
• 2-stage gas.....	✓	✓
• High pressure cutout.....	✓	✓
• Low pressure cutout.....	✓	✓
• Liquid line drier - factory installed.....	✓	✓
• Non-bleed expansion valves on indoor and outdoor coils.....	✓	✓
• Pressure taps, including liquid line taps, easily accessed and protected inside compressor compartment.....	✓	✓
• Right side electrical service access for high and low voltage connections.....	✓	✓
• Rugged steel basepan features deep drawn duct connections.....	✓	✓
• Steeply sloped composite drainpan.....	✓	✓
• Ships in horizontal configuration and converts quickly for downflow.....	✓	✓
• Copper tube, aluminum fin indoor coil.....	✓	✓
• All models are certified to UL 1995.....	✓	✓
• <b>20-year heat exchanger, 12-year compressor, 10-year coils, &amp; 10-year all other functional parts limited warranty with registration† (Residential use)</b> .....	✓	—
• <b>20-year heat exchanger, 10-year compressor, 10-year coils, &amp; 10-year all other functional parts limited warranty with registration† (Residential use)</b> .....	—	✓
• <b>Extended Warranties Available</b> .....	✓	✓

\*\*Constant airflow ECM (electronically commutated motor).

† Registered Limited Warranty terms are available when you register within 60 days of installation. You can register online at americanstandardair.com or by phone at 855-260-2975, otherwise American Standard Heating & Air Conditioning's Base Limited Warranty terms will apply. Base Limited Warranty information on specific products can be found on americanstandardair.com. Ask your dealer for full warranty information at time of purchase. Warranties are for residential and multi-family use only, some exclusions may apply.

**For dimensional/outline drawings, please refer to Product Data.  
 For information on Roof Curbs, please refer to the Accessories/Information Tab.**

For complete equipment / combination selections, installation instructions and warranty information, please refer to Product Data/Ratings and/or Installers Guides and Limited Warranty Handbooks.

BUILT TO A HIGHER STANDARD<sup>®</sup>

**American Standard**<sup>®</sup>

HEATING & AIR CONDITIONING

# Packaged Hybrid/Dual Fuel Convertible 2-5 Tons

**Table PK-6-A — Accessories**

Model Number	Description	Shipping Weight	4DCZ6 3-5	4DCY4 2-5
BAYACCDOR1A	Hinged Filter Access Door <sup>Ⓜ</sup>		3	2-3
BAYACCDOR2A	Hinged Filter Access Door <sup>Ⓜ</sup>		4-5	3½-5
BAYACCEADP1A	Adaptor Kit for Installation of <b>AccuClean™</b> and 5" Media Filter (Horizontal) <sup>Ⓢ</sup>	10	2-3	2-3
BAYACCEADP2A	Adaptor Kit for Installation of <b>AccuClean™</b> and 5" Media Filter (Horizontal) <sup>Ⓢ</sup>	12	3½-5	3½-5
BAYADAP050A	Adapter Curb (Cabinet A/B)		3	2-3
BAYADAP051A	Adapter Curb (Cabinet C)		3	2-3
BAYADAP052A	Adapter Curb (Cabinet A/B)		4-5	3½-5
BAYADAP053A	Adapter Curb (Cabinet C)		4-5	3½-5
BAYADAP054A	Adapter Curb (Cabinet D)		4-5	3½-5
BAYASCT001	Anti-Short Cycle Timer <sup>④</sup>		✓	✓
BAYCCHT102A	Crankcase Heater (230V) (Scroll)		4,5	3½-5
BAYCCHT103A	Crankcase Heater (230V) (Scroll)		3	2-3
BAYCCHT404B	Crankcase Heater (460V) (Scroll)		4,5	—
BATCCHT405A	Crankcase Heater (460V) (Scroll)		3	—
BAYCOVR112A	12" Duct Shroud (Covers Horizontal Ducts) <sup>Ⓣ</sup>		3-5	2-5
BAYCOVR118A	18" Duct Shroud (Covers Horizontal Ducts) <sup>Ⓣ</sup>		3-5	2-5
BAYCURB050A	Flat Roof Full Perimeter Curb (Insulated)	74	3	2-3
BAYCURB051A	Flat Roof Full Perimeter Curb (Insulated)	74	4-5	3½-5
BAYDMPR101A	2-Position Motorized Damper <sup>⑦⑧⑨⑩</sup>		3	2-3
BAYDMPR102A	2-Position Motorized Damper <sup>⑦⑧⑨⑩</sup>		4-5	3½-5
BAYECON101A	Economizer with Barometric Relief (Downflow) <sup>①②③④⑩⑪</sup>		—	2-3
BAYECON102A	Economizer with Barometric Relief (Downflow) <sup>①②③④⑩⑪</sup>		—	3½-5
BAYECON103A	Economizer with Barometric Relief (Downflow) <sup>①②③④⑩⑪</sup>	50	3	—
BAYECON104A	Economizer with Barometric Relief (Downflow) <sup>①②③④⑩⑪</sup>	65	4-5	—
BAYECON200A	Economizer (Horizontal) <sup>①②③④⑦</sup>		—	2-3
BAYECON201A	Economizer (Horizontal) <sup>①②③④⑦</sup>		—	3½-5
BAYECON203A	Economizer (Horizontal) <sup>①②③④⑦</sup>	85	3	—
BAYECON204A	Economizer (Horizontal) <sup>①②③④⑦</sup>	85	4-5	—
BAYENTH001A	Enthalpy Control Kit <sup>③</sup>	2	✓	✓
BAYEXMK001A	Extreme Conditions Mounting Kit		✓	✓
BAYEXMK002B	Extreme Conditions Mounting Kit		✓	✓
BAYEXMK003A	Extreme Conditions Mounting Kit (Used on Slab Mounts)		✓	✓
BAYFLTR101C	1-2" Filter Frame <sup>②</sup> -Requires one 18x25 filter (not included)	6	3	2-3
BAYFLTR201C	1-2" Filter Frame <sup>②④</sup> -Requires one 18x20 and one 18x18 (not included)	6	4-5	3½-5
BAYLIFT002B	Lifting Lug Kit	5	✓	✓
BAYLOAM105A	Low Ambient Control Kit	5	✓	✓
BAYRLAY004A	Economizer Relay <sup>①</sup>		—	✓
BAYRLAY006A	Economizer Relay <sup>①</sup>	1	✓	—
BAYOSAC001B	Outside Air Control for V.S. Economizer <sup>Ⓢ</sup>		3,4,5	—
BAYOSAH001A	Manual Fresh Air Damper <sup>②</sup>	6	3	2-3
BAYOSAH002A	Manual Fresh Air Damper <sup>②</sup>	8	4-5	3½-5
BAYQSTK300A	Start Kit (not factory installed)		✓	✓
BAYSQRD001B	16" Round Duct Adapter <sup>⑤</sup>	5	3	2-3
BAYSQRD002B	18" Round Duct Adapter <sup>⑤</sup>	3	4-5	2-5
BAYUTIL101B	Roof Curb Extension Kit		3	2-3
BAYUTIL102B	Roof Curb Extension Kit		4-5	3½-5

- ① Relay required with economizer on all heat pump applications.
- ② Must use filter frame when economizer/fresh air kit is used.
- ③ Dry bulb control standard with economizer.
- ④ 2-Stage cooling control required when using economizer.
- ⑤ It is the responsibility of the installing dealer to properly size the ductwork for each specific application.
- ⑥ BAYCOVR112, 118A will not cover BAYSQRD002B applications.
- ⑦ Does not contain barometric relief.
- ⑧ Max fresh air - 25%.
- ⑨ For non-continuous fan gas-heating applications, the damper opens only when the OD ambient is above 50° F.
- ⑩ It is the designer/engineer/installer's responsibility to review product specifications and technical literature to insure optimal performance and compliance to codes.
- ⑪ Temperature of mixed air entering the heat exchanger is monitored and fresh air intake may be reduced under certain conditions.
- ⑫ BAYACCDOR1A requires BAYFLTR101B & BAYACCDOR2A requires BAYFLTR201B. They are not backward compatible to BAYFLTR101/201A.
- ⑬ BAYOASH001/002 is not compatible with BAYACCDOR1A or BAYACCDOR2A.
- ⑭ When using a BAYACCDOR2A, two 18x20 filters are req

EXISTING CURB	NEW UNIT 4WC/DC**A	USE BAYADAP0**A
BAYCURB030,38A	024-036	50
BAYCURB030,38A	042-060	52
BAYCURB033A	024-036	51
BAYCURB033A	042-060	53
BAYCURB034A	042-060	54

**For dimensional/outline drawings, please refer to Product Data.  
For information on Roof Curbs, please refer to the Accessories/Information Tab.**

For complete equipment / combination selections, installation instructions and warranty information, please refer to Product Data/Ratings and/or Installers Guides and Limited Warranty Handbooks.

# Packaged Heat Pump Convertible 2-5 Tons

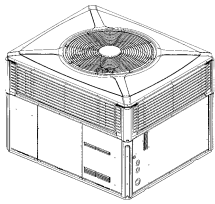

**4WCZ6**

**Table PK-7-A — 4WCZ6 - Platinum 16 - Convertible Packaged Heat Pump - R-410A**

Model Number	Capacity	SEER	EER High/Low	HSPF	Shipping Weight	MCA	Max Fuse	Sound Rating	Uncrated Dimensions (in.) H x D x W
<b>4WCZ6 – 208-230/1/60</b>									
4WCZ6024A1000A	24,000	16.00	12.00/18.30	8.20	442	19.5	30	67	38 x 42 x 49
4WCZ6036B1000A	36,000	16.00	12.20/17.45	8.30	468	24.3	35	70	38 x 42 x 49
4WCZ6048B1000A	47,500	16.00	12.00/17.50	8.50	607	34.2	50	72	42 x 45 x 59
4WCZ6060B1000A	57,000	15.00	11.50/15.90	8.30	623	42.0	60	74	42 x 45 x 59
<b>4WCZ6 – 208-230/3/60</b>									
4WCZ6036B3000A	36,000	16.00	12.20/17.45	8.30	468	19.7	30	70	38 x 42 x 49
4WCZ6048B3000A	47,500	16.00	12.00/17.50	8.50	607	25.2	35	72	42 x 45 x 59
4WCZ6060B3000A	57,000	15.00	11.50/15.90	8.30	623	30.0	45	74	42 x 45 x 59
<b>4WCZ6 – 460/3/60</b>									
4WCZ6036B4000A	36,000	16.00	12.20/17.45	8.30	468	11.9	15	70	38 x 42 x 49
4WCZ6048B4000A	47,500	16.00	12.00/17.50	8.50	607	15.3	20	72	42 x 45 x 59
4WCZ6060B4000A	57,000	15.00	11.50/15.90	8.30	623	17.0	20	74	42 x 45 x 59

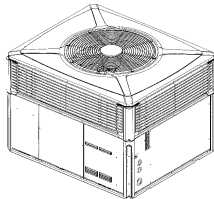

**4WCY5**

**Table PK-7-B — 4WCY5 - Gold 15 - Convertible Packaged Heat Pump - R-410A**

Model Number	Capacity	SEER/EER	HSPF	Shipping Weight	MCA	Max Fuse	Sound Rating	Uncrated Dimensions (in.) H x D x W
<b>4WCY5 – 208-230/1/60</b>								
4WCY5024A1000A	25,000	15.00/13.00	8.30	453	18.1	25	69.1	36 x 42 x 49
4WCY5030A1000A	30,000	15.00/12.00	8.20	430	22.8	35	70.0	38 x 42 x 49
4WCY5036A1000A	36,000	15.00/12.00	8.40	439	24.7	40	69.4	38 x 42 x 49
4WCY5042A1000A	41,500	15.00/12.00	8.40	607	28.6	45	72.0	38 x 45 x 59
4WCY5048A1000A	47,500	15.00/12.00	8.40	607	34.2	50	72.0	42 x 45 x 59
4WCY5060A1000A	57,500	15.00/11.50	8.40	623	42.2	60	74.0	42 x 45 x 59

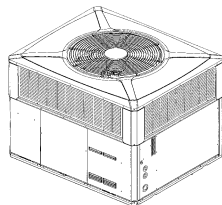

**4WCC4**

**Table PK-7-C — 4WCC4 - Silver 14 - Convertible Packaged Heat Pump - R-410A**

Model Number	Capacity	SEER/EER	HSPF	Shipping Weight	MCA	Max Fuse	Sound Rating	Uncrated Dimensions (in.) H x D x W
<b>4WCC4 – 208-230/1/60</b>								
4WCC4024A1000A	24,600	14.00/12.00	8.00	402	19.1	30	66	36 x 42 x 49
4WCC4030A1000A	30,400	14.00/12.00	8.00	430	22.6	35	69	38 x 42 x 49
4WCC4036A1000A	35,800	14.00/12.00	8.00	439	24.4	40	69	38 x 42 x 49
4WCC4042A1000A	43,000	14.00/12.00	8.00	548	28.4	45	71	40 x 45 x 59
4WCC4048A1000A	48,000	14.00/12.00	8.00	529	31.1	50	72	40 x 45 x 59
4WCC4060A1000A	58,000	14.00/12.00	8.00	594	39.1	60	77	42 x 45 x 59

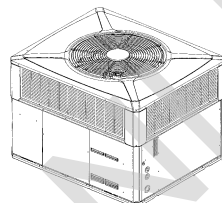

**4WCY4  
 (3-phase only)**

**Table PK-7-D — 4WCY4 - Gold 14 - Convertible Packaged Heat Pump - R-410A**

Model Number	Capacity	SEER/EER	HSPF	Shipping Weight	MCA	Max Fuse	Sound Rating	Uncrated Dimensions (in.) H x D x W
<b>4WCY4 – 208-230/3/60</b>								
4WCY4036B3000A	36,000	14.00/11.70	8.00	468	18.4	25	69	38 x 42 x 49
4WCY4048A3000C	47,000	14.00/11.75	8.00	607	25.3	35	73	38 x 45 x 59
4WCY4060A3000C	58,000	14.00/11.50	8.00	623	28.6	45	76	42 x 45 x 59

**For dimensional/outline drawings, please refer to Product Data.  
 For information on Roof Curbs, please refer to the Accessories/Information Tab.**

For complete equipment / combination selections, installation instructions and warranty information, please refer to Product Data/Ratings and/or Installers Guides and Limited Warranty Handbooks.

BUILT TO A HIGHER STANDARD<sup>®</sup>

**American Standard**<sup>®</sup>  
HEATING & AIR CONDITIONING

# Packaged Heat Pump Convertible 2-5 Tons

**Table PK-8-A — Features**

	4WCZ6 2-5	4WCY5 2-5	4WCY4 3-5	4WCC4 2-5
• SEER up to.....	16.00	15.00	14.25	14.00
• HSPF up to.....	8.50	8.20	8.00	8.00
• Exclusive <b>Duration™</b> high efficiency compressor with internal overload protection.....	✓	✓	✓	✓
• Factory supplied charge.....	R-410A	R-410A	R-410A	R-410A
• Composite <b>Vortica®</b> indoor blower.....	✓	✓	✓	✓
• Direct drive, multi-speed ECM blower motor (high efficiency)*.....	—	—	—	✓
• Direct drive, variable speed ECM blower motor **.....	✓	✓	✓	✓
• All aluminum <b>Spine Fin™</b> outdoor coil.....	✓	✓	✓	✓
• Swept-blade outdoor fan for quiet operation.....	✓	✓	✓	—
• Architecturally integrated louvers.....	✓	✓	✓	—
• Polyslate gray cabinet.....	✓	✓	✓	✓
• Single stage heating & cooling .....	—	2 - 3½	✓	✓
• Two stage heating & cooling .....	—	4, 5	—	—
• High pressure cutout.....	✓	✓	✓	✓
• Low pressure cutout.....	✓	✓	✓	✓
• Liquid line drier - factory installed.....	✓	✓	✓	✓
• Non-bleed expansion valves on indoor and outdoor coils.....	✓	✓	✓	✓
• Pressure taps, including liquid line taps, easily accessed and protected inside compressor compartment.....	✓	✓	✓	✓
• Right side electrical service access for high and low voltage connections.....	✓	✓	✓	✓
• Rugged steel basepan features deep drawn duct connections.....	✓	✓	✓	✓
• Steeply sloped composite drainpan.....	✓	✓	✓	✓
• Ships in horizontal configuration and converts quickly for downflow.....	✓	✓	✓	✓
• Copper tube, aluminum fin indoor coil.....	✓	✓	✓	✓
• All models are certified to UL 1995.....	✓	✓	✓	✓
• <b>10-year compressor, 10-year outdoor coil, &amp; 10-year all other functional parts limited warranty with registration† (Residential use)</b> .....	—	✓	✓	✓
• <b>12-year compressor, 10-year outdoor coil, &amp; 10-year all other functional parts limited warranty with registration† (Residential use)</b> .....	✓	—	—	—
• <b>Extended Warranties Available</b> .....	✓	✓	✓	✓

\*Constant torque ECM (electronically commutated motor).

\*\*Constant airflow ECM (electronically commutated motor).

† Registered Limited Warranty terms are available when you register within 60 days of installation. You can register online at americanstandardair.com or by phone at 855-260-2975, otherwise American Standard Heating & Air Conditioning's Base Limited Warranty terms will apply. Base Limited Warranty information on specific products can be found on americanstandardair.com. Ask your dealer for full warranty information at time of purchase. Warranties are for residential and multi-family use only, some exclusions may apply.

**For dimensional/outline drawings, please refer to Product Data.  
For information on Roof Curbs, please refer to the Accessories/Information Tab.**

For complete equipment / combination selections, installation instructions and warranty information, please refer to Product Data/Ratings and/or Installers Guides and Limited Warranty Handbooks.

# Packaged Heat Pump Convertible 2-5 Tons

**Table PK-9-A — Accessories**

Model Number	Description	Shipping Weight	4WCZ6	4WCY5	4WCY4	4WCC4
			2-5	2-5	3-5	2-5
BAYACCDOR1A	Hinged Filter Access Door <sup>®</sup> .....		2-3	2-3	3	2-3
BAYACCDOR2A	Hinged Filter Access Door <sup>®</sup> .....		4-5	3½-5	3½-5	3½-5
BAYACCEADP1A	Adaptor Kit for Installation of <b>AccuClean™</b> and 5" Media Filter (Horizontal) <sup>®</sup> ..... 10.....	10	2-3	2-3	3	2-3
BAYACCEADP2A	Adaptor Kit for Installation of <b>AccuClean™</b> and 5" Media Filter (Horizontal) <sup>®</sup> ..... 12.....	12	3½-5	3½-5	3½-5	3½-5
BAYADAP050A	Adapter Curb (Cabinet A/B).....		2-3	2-3	3	2-3
BAYADAP051A	Adapter Curb (Cabinet C).....		2-3	2-3	3	2-3
BAYADAP052A	Adapter Curb (Cabinet A/B).....		4-5	3½-5	3½-5	3½-5
BAYADAP053A	Adapter Curb (Cabinet C).....		4-5	3½-5	3½-5	3½-5
BAYADAP054A	Adapter Curb (Cabinet D).....		4-5	3½-5	3½-5	3½-5
BAYASCT001	Anti-Short Cycle Timer <sup>④</sup> .....		✓	✓	✓	✓
BAYCCHT102A	Crankcase Heater (230V) (Scroll).....		4,5	3½-5	3½-5	3½-5
BAYCCHT103A	Crankcase Heater (230V) (Scroll).....		2-3	2-3	3	2-3
BAYCCHT404B	Crankcase Heater (460V) (Scroll).....		4, 5	—	—	—
BAYCCHT405A	Crankcase Heater (460V) (Scroll).....		3	—	—	—
BAYCOVR112A	12" Duct Shroud (Covers Horizontal Ducts) <sup>®</sup> .....		2-5	2-5	3-5	2-5
BAYCOVR118A	18" Duct Shroud (Covers Horizontal Ducts) <sup>®</sup> .....		2-5	2-5	3-5	2-5
BAYCURB050A	Flat Roof Full Perimeter Curb (Insulated).....74.....	74	2-3	2-3	3	2-3
BAYCURB051A	Flat Roof Full Perimeter Curb (Insulated).....74.....	74	—	3½-5	3½-5	3½-5
BAYDMPR101A	2-Position Motorized Damper <sup>②⑦⑧⑨⑩</sup> .....		2-3	2-3	3	2-3
BAYDMPR102A	2-Position Motorized Damper <sup>②⑦⑧⑨⑩</sup> .....		4-5	3½-5	3½-5	3½-5
BAYECON101A	Economizer with Barometric Relief (Downflow) <sup>①②③④⑩⑪</sup> .....		—	2-3	2-3	2-3
BAYECON102A	Economizer with Barometric Relief (Downflow) <sup>①②③④⑩⑪</sup> .....		—	3½-5	3½-5	3½-5
BAYECON103A	Economizer with Barometric Relief (Downflow) <sup>①②③④⑩⑪</sup> .....50.....	50	2-3	—	—	—
BAYECON104A	Economizer with Barometric Relief (Downflow) <sup>①②③④⑩⑪</sup> .....65.....	65	4-5	—	—	—
BAYECON200A	Economizer (Horizontal) <sup>①②③④⑦</sup> .....		—	2-3	3	2-3
BAYECON201A	Economizer (Horizontal) <sup>①②③④⑦</sup> .....		—	3½-5	3½-5	3½-5
BAYENTH001A	Enthalpy Control Kit <sup>②</sup> .....2.....	2	✓	✓	✓	✓
BAYEXMK001A	Extreme Conditions Mounting Kit.....		✓	✓	✓	✓
BAYEXMK002B	Extreme Conditions Mounting Kit.....		✓	✓	✓	✓
BAYEXMK003A	Extreme Conditions Mounting Kit (Used on Slab Mounts).....		✓	✓	✓	✓
BAYFLTR101C	1-2" Filter Frame <sup>②</sup> -Requires one 18x25 filter (not included).....6.....	6	2-3	2-3	2-3	2-3
BAYFLTR201C	1-2" Filter Frame <sup>②④</sup> -Requires one 18x20, and one 18x18 filters (not included).....6.....	6	4-5	3½-5	3½-5	3½-5
BAYLIFT002B	Lifting Lug Kit.....5.....	5	✓	✓	✓	✓
BAYLOAM105A	Low Ambient Control Kit.....5.....	5	✓	✓	✓	✓
BAYRLAY004A	Economizer Relay <sup>①</sup> .....1.....	1	—	✓	✓	✓
BAYRLAY006A	Economizer Relay <sup>①</sup> .....1.....	1	✓	—	—	—
BAYOSAC001B	Outside Air Control for V.S. Economizer <sup>®</sup> .....		2,4,5	—	—	3-5
BAYOSAH001A	Manual Fresh Air Damper <sup>②</sup> .....6.....	6	2-3	2-3	3	2-3
BAYOSAH002A	Manual Fresh Air Damper <sup>②</sup> .....8.....	8	4,5	3½-5	3½-5	3½-5
BAYQSTK300A	Start Kit (not factory installed).....		✓	✓	✓	✓
BAYSQRD001B	16" Round Duct Adapter <sup>③</sup> .....5.....	5	2-3	2-3	2-3	2-3
BAYSQRD002B	18" Round Duct Adapter <sup>③</sup> .....3.....	3	4-5	2-5	2-5	2-5
BAYUTIL101B	Roof Curb Extension Kit.....		2-3	2-3	2-3	2-3
BAYUTIL102B	Roof Curb Extension Kit.....		4,5	3½-5	3½-5	3½-5

- ① Relay required with economizer on all heat pump applications.
- ② Must use filter frame when economizer/fresh air kit is used.
- ③ Dry bulb control standard with economizer.
- ④ 2-Stage cooling control required when using economizer.
- ⑤ It is the responsibility of the installing dealer to properly size the ductwork for each specific application.
- ⑥ BAYCOVR112,118A will not cover BAYSQRD002B applications.
- ⑦ Does not contain barometric relief.
- ⑧ Max fresh air - 25%.
- ⑨ For non-continuous fan gas-heating applications, the damper opens only when the OD ambient is above 50° F.
- ⑩ It is the designer/engineer/installer's responsibility to review product specifications and technical literature to insure optimal performance and compliance to codes.
- ⑪ Temperature of mixed air entering the heat exchanger is monitored and fresh air intake may be reduced under certain conditions.
- ⑫ BAYACCDOR1A requires BAYFLTR101B & BAYACCDOR2A requires BAYFLTR201B. They are not backward compatible to BAYFLTR101/201A.
- ⑬ BAYOASH001/002 is not compatible with BAYACCDOR1A or BAYACCDOR2A.
- ⑭ When using a BAYACCDOR2A, two 18x20 filters are required.

EXISTING CURB	NEW UNIT 4WCY*A	USE BAYADAP0**A
BAYCURB030,38A	024-036	50
BAYCURB030,38A	042-060	52
BAYCURB033A	024-036	51
BAYCURB033A	042-060	53
BAYCURB034A	042-060	54

**For dimensional/outline drawings, please refer to Product Data.  
 For information on Roof Curbs, please refer to the Accessories/Information Tab.**

For complete equipment / combination selections, installation instructions and warranty information, please refer to Product Data/Ratings and/or Installers Guides and Limited Warranty Handbooks.

BUILT TO A HIGHER STANDARD<sup>†</sup>**American Standard**<sup>®</sup>

HEATING &amp; AIR CONDITIONING

# Packaged Heat Pump Over/Under 2-3½ Tons

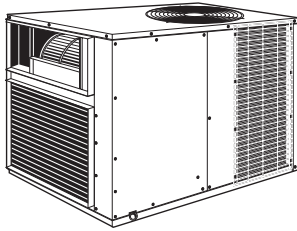
**4WHC4**

- **Duration**<sup>®</sup> compressor
- Over (supply) under (return) air
- Compressor internal overload protection
- Solenoid operated switchover valve
- Demand defrost control system
- Multi-speed direct drive blower motor
- High efficiency multi-speed ECM indoor motor on 4WHC4024-4036. 4WHC4042 models are variable speed.
- Weather resistant Powder Paint
- Copper tube, aluminum plate fin coils
- Top discharge condensing fan
- Factory installed wrap-around coil guard
- Top access to supplementary heater
- Pressure taps for refrigerant checks
- Polarized plug for easy field connection of low voltage to supplementary heaters
- Low ambient cooling to 55°F as manufactured
- Low ambient cooling to 0°F with accessory BAYLOAM011A
- All models are certified to UL 1995
- **10-year registered limited warranty on compressor, outdoor coil and all other functional parts<sup>†</sup> (Residential Use)**
- **Optional extended warranties**

**Table PK-10-A — Silver 14 – Over/Under Horizontal Unit – R-410A**

Model No.	Capacity	SEER/EER	HSPF	Uncrated Dimensions(in.) H X D X W	Weight (lbs.)	MCA*	Max Fuse*	Sound Rating
4WHC4024A1000B	24,800	16/13.6	8.2	31 x 44 x 32	322	18.7	25	74
4WHC4030A1000B	30,000	14/12	8	31 x 44 x 32	322	21.1	30	74
4WHC4036A1000B	35,800	14/12	8	31 x 44 x 32	322	26.2	40	75
4WHC4042A1000B	39,500	14/12	8	31 x 44 x 32	353	30.5	45	75
<b>Tons</b>	<b>Supply H x W</b>	<b>Return H x W</b>						
2 – 3½	8 <sup>3</sup> / <sub>8</sub> x 27 <sup>3</sup> / <sub>8</sub>	16 <sup>3</sup> / <sub>4</sub> x 27 <sup>3</sup> / <sub>8</sub>						

Dimensions are in inches. See Outline Dimensions.

\* Information subject to change. Please confirm with current Product Data/Service Facts for current factory production.

Compressor Types are: R1 = Reciprocating One Cylinder, R2 = Reciprocating Two Cylinder, S = Scroll

**Table PK-10-B— Supplementary Heaters – Heater Matrix**

Model No.①	Power Supply	kW Ratings	Used With	Shipping Weight
BAYHTRC106A	208/240/1/60	4.33/5.76 kW	4WHC4024-42	9
BAYHTRC109A	208/240/1/60	6.12/8.16 kW	4WHC4036-42	10
BAYHTRC111A	208/240/1/60	7.98/10.56 kW	4WHC4024-42	10
BAYHTRC117A	208/240/1/60	12.98/17.28 kW	4WHC4030-42	23

**Table PK-10-C — Accessories/Comfort Controls**

Model No.	Description	Used With	Shipping Weight
BAYASCT001②③	Anti-Short Cycle Timer	All 4WHC4 Models	1
BAYECMT003A	Extreme Conditions Mounting Kit (Slab or Rack Mount)	All 4WHC4 Models	2
BAYLOAM011A	Low Ambient Cooling Kit	All 4WHC4 Models	5
TAYASCT501A③	5 Minute Delay Relay	All 4WHC4 Models	2
TCONT402A	3Heat/2Clg (Heat Pump/A/C)	All 4WHC4 Models	1
TCONT602A	2Heat/2Clg (Heat Pump/A/C)	All 4WHC4 Models	1
TCONT802A	3Heat/2Clg (Heat Pump/A/C)	All 4WHC4 Models	1
TCONT803A	3Heat/2Clg (Heat Pump/A/C) w/Humidity Display	All 4WHC4 Models	1

① Heaters must have an "A" in eleventh digit to work on 4WHC4 models.

② Not for use with electronic thermostats.

③ Activated on Power Off.

<sup>†</sup> Registered Limited Warranty terms are available when you register within 60 days of installation. You can register online at [americanstandardair.com](http://americanstandardair.com) or by phone at 855-260-2975, otherwise American Standard Heating & Air Conditioning's Base Limited Warranty terms will apply. Base Limited Warranty information on specific products can be found on [americanstandardair.com](http://americanstandardair.com). Ask your dealer for full warranty information at time of purchase. Warranties are for residential and multi-family use only, some exclusions may apply.

**For dimensional/outline drawings, please refer to Product Data.  
For information on Roof Curbs, please refer to the Accessories/Information Tab.**

For complete equipment / combination selections, installation instructions and warranty information, please refer to Product Data/Ratings and/or Installers Guides and Limited Warranty Handbooks.



# Packaged Gas/Electric Convertible 2-5 Tons

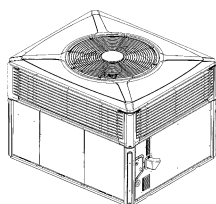

**4YCZ6**

**Table PK-11-A — 4YCZ6 - Platinum 16 - Convertible Packaged Gas/Electric - R-410A**

Model Number	Cooling Capacity (BTUH)	Heating Capacity Output (1 Stg./2 Stg.)	SEER	EER High/Low	AFUE(%)	Shipping Weight	MCA	Max Fuse	Sound Rating	Uncrated Dimensions (in.) H x D x W
<b>4YCZ6 – 208-230/1/60</b>										
4YCZ6024A1060A	24,000	38,800/48,600	16.00	12.00/17.60	81.0	440	19.5	30	65	36 x 42 x 49
4YCZ6036C1070A	35,600	45,000/57,000	16.60	12.00/13.60	81.0	488	24.2	35	70	38 x 42 x 49
4YCZ6036C1090A	35,600	58,000/73,000	16.60	12.00/13.60	81.0	488	24.2	35	70	38 x 42 x 49
4YCZ6048C1090A	48,000	58,000/73,000	16.00	12.00/13.48	81.0	659	34.1	50	71	42 x 45 x 59
4YCZ6048C1115A	48,000	75,000/93,000	16.00	12.00/13.48	81.0	665	34.1	50	71	42 x 45 x 59
4YCZ6060C1115A	57,500	75,000/93,000	15.10	11.40/12.64	81.0	676	44.4	60	73	42 x 45 x 59
<b>4YCZ6 – 208-230/3/60</b>										
4YCZ6036A3075C	35,600	45,000/60,000	16.60	12.00/13.60	80.0	488	19.7	30	70	38 x 42 x 49
4YCZ6036A3096C	35,600	57,600/77,000	16.60	12.00/13.60	80.0	493	19.7	30	70	38 x 42 x 49
4YCZ6048A3096C	48,000	57,600/77,000	16.00	12.00/13.48	80.0	659	25.2	35	71	42 x 45 x 59
4YCZ6048A3120C	48,000	72,000/96,000	16.00	12.00/13.48	80.0	665	25.2	35	71	42 x 45 x 59
4YCZ6060A3120C	57,500	72,000/96,000	15.10	11.40/12.65	80.0	676	28.6	40	73	42 x 45 x 59
<b>4YCZ6 – 460/3/60</b>										
4YCZ6036A4075D	35,600	45,000/60,000	16.60	12.00/13.60	79.0	488	11.9	15	70	38 x 42 x 49
4YCZ6036A4096D	35,600	57,600/77,000	16.60	12.00/13.60	80.0	493	11.9	15	70	38 x 42 x 49
4YCZ6048A4096D	48,000	57,600/77,000	16.00	12.00/13.48	80.0	659	15.3	20	71	42 x 45 x 59
4YCZ6048A4120D	48,000	72,000/96,000	16.00	12.00/13.48	80.0	665	15.3	20	71	42 x 45 x 59
4YCZ6060A4120D	57,500	72,000/96,000	15.10	11.40/12.65	80.0	676	17.2	20	73	42 x 45 x 59

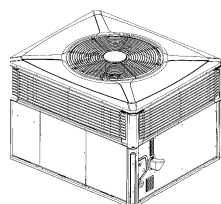

**4ICY5**

**Table PK-11-B — 4ICY5- Gold 15 - Convertible Packaged Gas/Electric - R-410A**

Model Number	Cooling Capacity (BTUH)	Heating Capacity Output (1 Stg./2 Stg.)	SEER/EER	AFUE(%)	Shipping Weight	MCA	Max Fuse	Sound Rating	Uncrated Dimensions (in.) H x D x W
<b>4ICY5 – 208-230/1/60</b>									
4ICY5024A1060A	23,800	48,000/60,000	15.00/12.00	81	425	18.4	25	65	36 x 42 x 49
4ICY5030A1070A	28,400	56,000/70,000	15.00/12.00	81	455	21.2	30	70	36 x 42 x 49
4ICY5036A1070A	36,000	56,000/70,000	15.00/12.00	81	460	23.8	35	69	38 x 42 x 49
4ICY5036A1090A	36,000	72,000/90,000	15.00/12.00	81	465	23.8	35	69	38 x 42 x 49
4ICY5042A1090A	41,000	72,000/90,000	15.00/12.00	81	593	28.6	45	71	38 x 45 x 59
4ICY5048A1090A	48,000	72,000/90,000	15.00/12.00	81	616	34.2	50	71	38 x 45 x 59
4ICY5048A1115A	48,000	90,000/115,000	15.00/12.00	81	622	34.2	50	71	38 x 45 x 59
4ICY5060A1115A	57,500	92,000/115,000	15.00/11.40	81	633	44.4	60	73	42 x 45 x 59

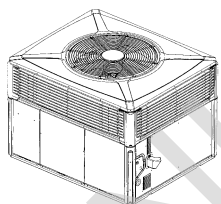

**4ICY4**

(3-phase only)

**Table PK-11-C — 4ICY4 - Gold 14 - Convertible Packaged Gas/Electric - R-410A**

Model Number	Cooling Capacity (BTUH)	Heating Capacity Output (1 Stg./2 Stg.)	SEER/EER	AFUE(%)	Shipping Weight	MCA	Max Fuse	Sound Rating	Uncrated Dimensions (in.) H x D x W
<b>4ICY4 – 208-230/3/60</b>									
4ICY4036B3075A	38,000	45,000/60,000	14.30/12.00	80.0	488	18.5	25	69	38 x 42 x 49
4ICY4036B3096A	38,000	57,600/77,000	14.20/12.00	80.0	493	18.5	25	69	38 x 42 x 49
4ICY4048B3096A	48,000	57,600/77,000	14.20/12.00	80.0	653	25.3	35	73	38 x 45 x 59
4ICY4048B3120A	48,000	72,000/96,000	14.20/11.90	80.0	659	25.3	35	73	38 x 45 x 59
4ICY4060A3120B	58,500	72,000/96,000	14.30/12.00	80.0	676	28.6	40	76	42 x 45 x 59

**For dimensional/outline drawings, please refer to Product Data.  
 For information on Roof Curbs, please refer to the Accessories/Information Tab.**

For complete equipment / combination selections, installation instructions and warranty information, please refer to Product Data/Ratings and/or Installers Guides and Limited Warranty Handbooks.

BUILT TO A HIGHER STANDARD

**American Standard**  
HEATING & AIR CONDITIONING

# Packaged Gas/Electric Convertible 2-5 Tons

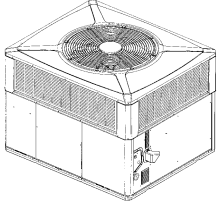

**4YCC4**

**Table PK-12-A — 4YCC4 - Silver 14 - Convertible Packaged Gas/Electric - R-410A**

Model Number	Cooling Capacity (BTUH)	Heating Capacity Input/Output	SEER/EER	AFUE(%)	Shipping Weight	MCA	Max Fuse	Sound Rating	Cabinet Dimensions (in.) H x D x W
<b>4YCC4 – 208-230/1/60</b>									
4YCC4024A1060A	24,600	60,000/49,000	14.00/12.00	81.0	481	19.1	30	67	36 x 42 x 49
4YCC4030A1070A	28,200	70,000/57,000	14.00/12.00	81.0	481	22.6	35	69	36 x 42 x 49
4YCC4036A1070A	37,000	70,000/57,000	14.00/12.00	81.0	488	24.5	40	69	38 x 42 x 49
4YCC4036A1090A	37,000	90,000/73,000	14.00/12.00	81.0	493	24.5	40	69	38 x 42 x 49
4YCC4042A1060A	40,500	60,000/49,000	14.00/12.00	81.0	653	28.5	45	75	36 x 45 x 59
4YCC4042A1090A	40,500	90,000/73,000	14.00/12.00	81.0	653	28.5	45	75	36 x 45 x 59
4YCC4048A1070A	46,500	70,000/57,000	14.00/11.50	81.0	645	32.0	50	73	40 x 45 x 59
4YCC4048A1090A	46,500	90,000/73,000	14.00/11.50	81.0	653	32.0	50	73	40 x 45 x 59
4YCC4060A1090A	58,000	90,000/73,000	14.00/11.50	81.0	678	39.1	60	73	40 x 45 x 59
4YCC4060A1115A	58,000	115,000/93,000	14.00/11.50	81.0	684	39.1	60	73	40 x 45 x 59

ONLINE ONLY COPY

**For dimensional/outline drawings, please refer to Product Data.  
For information on Roof Curbs, please refer to the Accessories/Information Tab.**

For complete equipment / combination selections, installation instructions and warranty information, please refer to Product Data/Ratings and/or Installers Guides and Limited Warranty Handbooks.

# Packaged Gas/Electric Convertible 2-5 Tons

Table PK-13-A — Features	4YCZ6 2-5	4YCY5 2-5	4YCY4 2-5	4YCC4 2-5
• SEER up to .....	16.60	15.00	14.25	14.00
• Exclusive <b>Duration™</b> high efficiency compressor with internal overload protection .....	✓	✓	✓	✓
• Factory supplied charge .....	R-410A	R-410A	R-410A	R-410A
• Composite <b>Vortica®</b> indoor blower .....	✓	✓	✓	✓
• High efficiency ECM indoor blower motor with <b>Comfort-R™</b> airflow system .....	✓	✓	✓	✓
• Direct drive, multi-speed ECM blower motor (high efficiency)* .....	—	—	—	—
• All aluminum <b>Spine Fin™</b> outdoor coil .....	✓	✓	✓	✓
• Swept-blade outdoor fan for quiet operation .....	✓	✓	✓	✓
• Architecturally integrated louvers and corner guards .....	✓	✓	✓	✓
• Polyslate gray cabinet .....	✓	✓	✓	✓
• Stainless steel heat exchanger and burners .....	✓	✓	✓	✓
• Single stage cool .....	—	2-3½	✓	✓
• Single stage gas .....	—	—	—	✓
• 2-stage cooling .....	✓	4, 5	—	—
• 2-stage gas .....	✓	✓	✓	—
• High pressure cutout .....	✓	✓	✓	✓
• Low pressure cutout .....	✓	✓	✓	✓
• Liquid line drier - factory installed .....	✓	✓	✓	✓
• Non-bleed expansion valves on indoor coil .....	✓	✓	✓	✓
• Pressure taps, including liquid line taps, easily accessed and protected inside compressor compartment .....	✓	✓	✓	✓
• Right side electrical service access for high and low voltage connections .....	✓	✓	✓	✓
• Rugged steel basepan features deep drawn duct connections .....	✓	✓	✓	✓
• Steeply sloped composite drainpan .....	✓	✓	✓	✓
• Ships in horizontal configuration and converts quickly for downflow .....	✓	✓	✓	✓
• Copper tube, aluminum fin indoor coil .....	3, 4, 5	3, 4, 5	✓	5
• All aluminum indoor coil .....	2	2, 2½, 3½	—	2-4
• All models are certified to ANSI Z21.47/CSA 2.3 .....	✓	✓	✓	—
• <b>20-year heat exchanger, 12-year compressor, 10-year coils, &amp; 10-year all other functional parts limited warranty with registration† (Residential use)</b> .....	✓	—	—	—
• <b>20-year heat exchanger, 10-year compressor, 10-year coils, &amp; 10-year all other functional parts limited warranty with registration† (Residential use)</b> .....	—	✓	✓	✓
• <b>Extended warranties available</b> .....	✓	✓	✓	✓

\*Constant torque ECM (electronically commutated motor).

† Registered Limited Warranty terms are available when you register within 60 days of installation. You can register online at americanstandardair.com or by phone at 855-260-2975, otherwise American Standard Heating & Air Conditioning's Base Limited Warranty terms will apply. Base Limited Warranty information on specific products can be found on americanstandardair.com. Ask your dealer for full warranty information at time of purchase. Warranties are for residential and multi-family use only, some exclusions may apply.

**For dimensional/outline drawings, please refer to Product Data.  
 For information on Roof Curbs, please refer to the Accessories/Information Tab.**

BUILT TO A HIGHER STANDARD<sup>®</sup>

**American Standard**<sup>®</sup>

HEATING & AIR CONDITIONING

# Packaged Gas/Electric Convertible 2-5 Tons

**Table PK-14-A — Accessories**

		4YCZ6 2-5	4YCY5 2-5	4YCY4 3-5	4YCC4 2-5
Model Number	Description	Shipping Weight			
BAYACCDOR1A	Hinged Filter Access Door <sup>②</sup>	2-3	2-3	2-3	2-3
BAYACCDOR2A	Hinged Filter Access Door <sup>②</sup>	3½-5	3½-5	3½-5	3½-5
BAYACCEADP1A	Adaptor Kit for Installation of <b>AccuClean™</b> and 5" Media Filter (Horizontal) <sup>⑩</sup>	2-3	2-3	3	2-3
BAYACCEADP2A	Adaptor Kit for Installation of <b>AccuClean™</b> and 5" Media Filter (Horizontal) <sup>⑩</sup>	12	12	12	12
BAYADAP050A	Adapter Curb (Cabinet A/B)	2-3	2-3	2-3	2-3
BAYADAP051A	Adapter Curb (Cabinet C)	2-3	2-3	2-3	2-3
BAYADAP052A	Adapter Curb (Cabinet A/B)	4-5	3½-5	3½-5	3½-5
BAYADAP053A	Adapter Curb (Cabinet C)	4-5	3½-5	3½-5	3½-5
BAYADAP054A	Adapter Curb (Cabinet D)	4-5	3½-5	3½-5	3½-5
BAYASCT001	Anti-Short Cycle Timer <sup>④</sup>	✓	—	✓	✓
BAYCCHT102A	Crankcase Heater (230v) (Scroll)	—	3½-5	—	3½-5
BAYCCHT103A	Crankcase Heater (230V) (Scroll)	2-3	2-3	3	2-3
BAYCCHT404B	Crankcase Heater (460v) (Scroll)	4-5	—	—	—
BAYCCHT405A	Crankcase Heater (460v) (Scroll)	3	—	—	—
BAYCOVR112A	12" Duct Shroud (Covers Horizontal Ducts) <sup>⑥</sup>	2-5	2-5	2-5	2-5
BAYCOVR118A	18" Duct Shroud (Covers Horizontal Ducts) <sup>⑥</sup>	2-5	2-5	2-5	2-5
BAYCURB050A	Flat Roof Full Perimeter Curb (Insulated)	74	3	2-3	2-3
BAYCURB051A	Flat Roof Full Perimeter Curb (Insulated)	74	4-5	3½-5	3½-5
BAYDMPR101A	Motorized Fresh Air Damper <sup>⑦⑧⑨⑩</sup>	2-3	2-3	2-3	2-3
BAYDMPR102A	Motorized Fresh Air Damper <sup>⑦⑧⑨⑩</sup>	4-5	3½-5	3½-5	3½-5
BAYECON101A	Economizer with Barometric Relief (Downflow) <sup>①②③④⑤</sup>	50	—	2-3	2-3
BAYECON102A	Economizer with Barometric Relief (Downflow) <sup>①②③④⑤</sup>	65	—	3½	½-5
BAYECON103A	Economizer with Barometric Relief (Downflow) <sup>①②③④⑤</sup>	2-3	—	—	—
BAYECON104A	Economizer with Barometric Relief (Downflow) <sup>①②③④⑤</sup>	4-5	4-5	—	—
BAYECON200A	Economizer (Horizontal) <sup>①②③⑦</sup>	85	—	2-3	2-3
BAYECON201A	Economizer (Horizontal) <sup>①②③⑦</sup>	85	—	3½	3½-5
BAYECON203A	Economizer (Horizontal) <sup>①②③⑦</sup>	2-3	—	—	—
BAYECON204A	Economizer (Horizontal) <sup>①②③⑦</sup>	4-5	4-5	—	—
BAYENTH001A	Enthalpy Control Kit <sup>②</sup>	2	✓	✓	✓
BAYEXMK001A	Extreme Conditions Mounting Kit (Used on BAYCURB & BAYADAP)	✓	✓	✓	✓
BAYEXMK002B	Extreme Conditions Mounting Kit (Used on BAYUTIL)	✓	✓	✓	✓
BAYEXMK003A	Extreme Conditions Mounting Kit (Used on Slab Mounts)	✓	✓	✓	✓
BAYFLTR101C	1-2" Filter Frame <sup>①</sup> -Requires one 18x25 filter (not included)	6	2-3	2-3	2-3
BAYFLTR201C	1-2" Filter Frame <sup>①④</sup> -Requires one 18x20, and one 18x18 filter (not inc)	6	4-5	3½-5	3½-5
BAYLIFT002B	Lifting Lug Kit	5	✓	✓	✓
BAYLOAM105A	Low Ambient Control Kit	5	✓	✓	✓
BAYLPKT100A	LP Conversion Kit	115K	115K	115K	115K
BAYLPKT101A	LP Conversion Kit	60K,90K	60K, 90K	60K,90K	60K, 90K
BAYLPKT102A	LP Conversion Kit	70K	70K	70K	70K
BAYOSAC001B	Outside Air Control for V.S. Economizer <sup>⑧</sup>	3,4,5	4-5	—	—
BAYOSAH001A	Manual Fresh Air Damper <sup>①</sup>	6	2-3	2-3	2-3
BAYOSAH002A	Manual Fresh Air Damper <sup>①</sup>	8	4-5	3½-5	3½-5
BAYQSTK301A	Start Kit (not factory installed)	✓	✓	—	✓
BAYSQRD001B	16" Round Duct Adapter <sup>③</sup>	5	2-3	2-3	2-3
BAYSQRD002B	18" Round Duct Adapter <sup>③</sup>	3	4-5	2-5	2-5
BAYUTIL101B	Roof Curb Utility Extension Kit	2-3	2-3	2-3	2-3
BAYUTIL102B	Roof Curb Utility Extension Kit	4-5	3½-5	3½-5	3½-5

- ① Must use filter frame when economizer/fresh air kit is used.
- ② Dry bulb control standard with economizer.
- ③ 2-Stage cooling control required when using economizer.
- ④ Do not use with electronic thermostats.
- ⑤ It is the responsibility of the installing dealer to properly size the ductwork for each specific application.
- ⑥ BAYCOVR112,118A will not cover BAYSQRD002B applications.
- ⑦ Does not contain barometric relief.
- ⑧ Max fresh air - 25%.
- ⑨ For non-continuous fan gas-heating applications, the damper opens only when the OD ambient is above 50° F.
- ⑩ It is the designer/engineer/installer's responsibility to review product specifications and technical literature to insure optimal performance and compliance to codes.
- ⑪ Temperature of mixed air entering the heat exchanger is monitored and fresh air intake may be reduced under certain conditions.
- ⑫ BAYACCDOR1A requires BAYFLTR101B & BAYACCDOR2A requires BAYFLTR201B. They are not backward compatible to BAYFLTR101/201A.
- ⑬ BAYOASH001/002 is not compatible with BAYACCDOR1A or BAYACCDOR2A
- ⑭ When using a BAYACCDOR2A, two 18x20 filters are required.

EXISTING CURB	NEW UNIT 4TC/WC/YC****A	USE BAYADAP0**A
BAYCURB030,38A	024-036	50
BAYCURB030,38A	042-060	52
BAYCURB033A	024-036	51
BAYCURB033A	042-060	53
BAYCURB034A	042-060	54

**For dimensional/outline drawings, please refer to Product Data.  
For information on Roof Curbs, please refer to the Accessories/Information Tab.**

For complete equipment / combination selections, installation instructions and warranty information, please refer to Product Data/Ratings and/or Installers Guides and Limited Warranty Handbooks.

# Single Power Entry Kits Packaged Convertible 2-5 Tons

	SINGLE POWER ENTRY KIT	HEATER	4TCC4	4TCY5	4WCC4	4WCY5	4WCZ6
SINGLE PHASE (208-240v)	BAYSPEK060	BAYHTRV105	2-4	2-5	2-3	2-3½	2-3
		BAYHTRV108	2-4	2-5	2	—	—
		BAYHTRV110	2-4	2-3	—	—	—
	BAYSPEK062	BAYHTRV105	5	—	3½-5	4-5	4-5
		BAYHTRV108	5	—	2½-5	2-5	2-5
		BAYHTRV110	5	3½-5	2-5	2-5	2-5
	BAYSPEK063	BAYHTRV115	2½-5	2½-5	2½-5	2½-5	3-5
		BAYHTRV120	4-5	3½-5	3½-5	3½-5	4-5

	SINGLE POWER ENTRY KIT	HEATER	4TCC3	4TCX3	4TCY4	4WCC3	4WCX3	4WCY4	4WCZ6
3 PHASE (208/240v)	BAYSPEK064	BAYHTRV315	—	—	—	3-5	3-5	3-5	3-5
		BAYHTRV320	4-5	4-5	4-5	4-5	4-5	4-5	4-5
	BAYSPEK065	BAYHTRV310	—	—	—	5	5	5	5
	BAYSPEK061	BAYHTRV305	3-5	3-5	3-5	3-5	3-5	3-5	3-5
		BAYHTRV308	3-5	3-5	3-5	3-5	3-5	3-5	3-5
		BAYHTRV310	3-5	3-5	3-5	3-4	3-4	3-4	3-4
		BAYHTRV315	3-5	3-5	3-5	—	—	—	—
3 PHASE (460v)	BAYSPEK061	BAYHTRV405	3-5	3-5	—	3-5	3-5	—	3-5
		BAYHTRV408	3-5	3-5	—	3-5	3-5	—	3-5
		BAYHTRV410	3-5	3-5	—	3-5	3-5	—	3-5
		BAYHTRV415	3-5	3-5	—	3-5	3-5	—	3-5
		BAYHTRV420	4-5	4-5	—	4-5	4-5	—	4-5

**For dimensional/outline drawings, please refer to Product Data.  
For information on Roof Curbs, please refer to the Accessories/Information Tab.**

# Supplemental Heater Table

## Packaged Convertible 2-5 Tons

	BAYHTRV105 3.76/5.0 kW	BAYHTRV108 6.0/8.0 kW	BAYHTRV110 7.50/10.0 kW	BAYHTRV115 11.27/15.0 kW	BAYHTRV120 15.00/20.0 kW	BAYHTRV125 18.78/25.0 kW
4TCY5024A1	Y	Y	Y	--	--	--
4TCY5030A1	Y	Y	Y	Y	--	--
4TCY5036A1	Y	Y	Y	Y	--	--
4TCY5042A1	Y	Y	Y	Y	Y	Y
4TCY5048A1	Y	Y	Y	Y	Y	Y
4TCY5060A1	Y	Y	Y	Y	Y	Y
4TCC4024A1	Y	Y	Y	--	--	--
4TCC4030A1	Y	Y	Y	Y	--	--
4TCC4036A1	Y	Y	Y	Y	--	--
4TCC4042A1	Y	Y	Y	Y	--	--
4TCC4048A1	Y	Y	Y	Y	Y	--
4TCC4060A1	Y	Y	Y	Y	Y	Y
4WCZ6024A1	Y	Y	Y	--	--	--
4WCZ6036B1	Y	Y	Y	Y	--	--
4WCZ6048B1	Y	Y	Y	Y	Y	Y
4WCZ6060B1	Y	Y	Y	Y	Y	Y
4WCY5024A1	Y	Y	Y	--	--	--
4WCY5030A1	Y	Y	Y	Y	--	--
4WCY5036A1	Y	Y	Y	Y	--	--
4WCY5042A1	Y	Y	Y	Y	Y	Y
4WCY5048A1	Y	Y	Y	Y	Y	Y
4WCY5060A1	Y	Y	Y	Y	Y	Y
4WCC4024A1	Y	Y	Y	--	--	--
4WCC4030A1	Y	Y	Y	Y	--	--
4WCC4036A1	Y	Y	Y	Y	--	--
4WCC4042A1	Y	Y	Y	Y	--	--
4WCC4048A1	Y	Y	Y	Y	Y	--
4WCC4060A1	Y	Y	Y	Y	Y	Y

**For dimensional/outline drawings, please refer to Product Data.**  
**For information on Roof Curbs, please refer to the Accessories/Information Tab.**

For complete equipment / combination selections, installation instructions and warranty information, please refer to Product Data/Ratings and/or Installers Guides and Limited Warranty Handbooks.

BUILT TO A HIGHER STANDARD

**American Standard**  
HEATING & AIR CONDITIONING

# Supplemental Heater Table Packaged Convertible 2-5 Tons

Supplemental Heaters - Packaged

	BAYHTRV305 3.76/5.0 kW (3PH)	BAYHTRV308 6.0/8.0 kW (3PH)	BAYHTRV310 7.50/10.0 kW (1PH)	BAYHTRV315 11.27/15.0 kW (3PH)	BAYHTRV320 15.0/20.0 kW (3PH)	BAYHTRV325 18.78/25.0 kW (3PH)
4TCY4036B3	Y	Y	Y	Y	--	--
4TCY4048B3	Y	Y	Y	Y	Y	Y
4TCY4060B3	Y	Y	Y	Y	Y	Y
4TCX3036A3	Y	Y	Y	Y	--	--
4TCX3048A3	Y	Y	Y	Y	Y	--
4TCX3060A3	Y	Y	Y	Y	Y	Y
4TCC3036A3	Y	Y	Y	Y	--	--
4TCC3048A3	Y	Y	Y	Y	Y	--
4TCC3060A3	Y	Y	Y	Y	Y	Y
4WCZ6036B3	Y	Y	Y	Y	--	--
4WCZ6048B3	Y	Y	Y	Y	Y	Y
4WCZ6060B3	Y	Y	Y	Y	Y	Y
4WCY4036A3	Y	Y	Y	Y	--	--
4WCY4048A3	Y	Y	Y	Y	Y	--
4WCY4060B3	Y	Y	Y	Y	Y	--
4WCX3036A3	Y	Y	Y	Y	--	--
4WCX3048A3	Y	Y	Y	Y	Y	--
4WCX3060A3	Y	Y	Y	Y	Y	Y
4WCC3036A3	Y	Y	Y	Y	--	--
4WCC3048A3	Y	Y	Y	Y	Y	--
4WCC3060A3	Y	Y	Y	Y	Y	Y
	BAYHTRV405 5.0 kW (3PH)	BAYHTRV408 8.0 kW (480V 3 PH)	BAYHTRV410 10.0 kW (3PH)	BAYHTRV415 15.0 kW (480V 3 PH)	BAYHTRV420 20.0 kW (480V 3 PH)	BAYHTRV425 25.0 kW (480V 3 PH)
4TCY3036A4	Y	Y	Y	Y	--	--
4TCY3048A4	Y	Y	Y	Y	Y	--
4TCY3060A4	Y	Y	Y	Y	Y	Y
4TCX3036A4	Y	Y	Y	Y	--	--
4TCX3048A4	Y	Y	Y	Y	Y	--
4TCX3060A4	Y	Y	Y	Y	Y	Y
4TCC3036A4	Y	Y	Y	Y	--	--
4TCC3048A4	Y	Y	Y	Y	Y	--
4TCC3060A4	Y	Y	Y	Y	Y	Y
4WCZ6036B4	Y	Y	Y	Y	--	--
4WCZ6048B4	Y	Y	Y	Y	Y	--
4WCZ6060B4	Y	Y	Y	Y	Y	--
4WCX3036A4	Y	Y	Y	Y	--	--
4WCX3048A4	Y	Y	Y	Y	Y	--
4WCX3060A4	Y	Y	Y	Y	Y	Y
4WCC3036A4	Y	Y	Y	Y	--	--
4WCC3048A4	Y	Y	Y	Y	Y	--
4WCC3060A4	Y	Y	Y	Y	Y	Y

**For dimensional/outline drawings, please refer to Product Data.  
For information on Roof Curbs, please refer to the Accessories/Information Tab.**

For complete equipment / combination selections, installation instructions and warranty information, please refer to Product Data/Ratings and/or Installers Guides and Limited Warranty Handbooks.

# Model Nomenclature

**AMERISTAR**  
BY AMERICAN STANDARD HEATING & AIR

A 4 A C 4 0 4 8 A 1 0 0 A A

**AC and HP**

- Brand \_\_\_\_\_
- A = Ameristar Brand
- Refrigerant Type \_\_\_\_\_
- 4 = R410A
- Product Family \_\_\_\_\_
- AC = Air Conditioner
- HP = Heat Pump
- Nominal Efficiency Rating \_\_\_\_\_
- 3 = 13 SEER
- 4 = 14 SEER
- 6 = 16 SEER
- Nominal Capacity \_\_\_\_\_
- BTU/Hour x 1000
- Major Development Sequence \_\_\_\_\_
- Primary Design / Form Series
- Alphabetic Character "A" through "Z"
- Electric Power Supply \_\_\_\_\_
- 1 = 200-230V/1PH/60Hz or 208-230V/1PH/60Hz
- Secondary Function \_\_\_\_\_
- 000 = No Secondary Function
- Minor Design Sequence/Series - Design Change \_\_\_\_\_
- Alphabetic Character "A" through "Z"

**AMERISTAR**  
BY AMERICAN STANDARD HEATING & AIR

A 8 0 1 X 0 4 0 A M 2 S A A A

**Furnace**

- Brand \_\_\_\_\_
- A = Ameristar Brand
- Model Family (Nominal Efficiency) \_\_\_\_\_
- 80 = 80% Non-Condensing
- 95 = 95% + Condensing
- Gas Valve Stages \_\_\_\_\_
- 1 = 1 Stage Gas Valve
- 2 = 2 Stage Gas Valve
- Blower Type \_\_\_\_\_
- P = PSC Motor
- X = Constant Torque Motor
- V = Variable Speed Motor
- BTU Input (Nominal Heating Capacity) \_\_\_\_\_
- BTU/Hour x 1000
- Cabinet Width \_\_\_\_\_
- A = 14.5"
- B = 17.5"
- C = 21"
- D = 24.5"
- Orientation \_\_\_\_\_
- U = Upflow/Horizontal Right/Horizontal Left
- D = Downflow
- M = Multipoise
- Nominal Cooling Airflow (in tons) \_\_\_\_\_
- Type \_\_\_\_\_
- S = Standard system
- T = 40ng/J NOx
- L = 14 ng/J NOx
- Major Development Sequence \_\_\_\_\_
- Primary Design/Form Series
- Alphabetic Letter A through Z
- Minor Development Sequence/Series \_\_\_\_\_
- Design Change
- Alphabetic Letter A through Z

**AMERISTAR**  
BY AMERICAN STANDARD HEATING & AIR

A 4 A H 4 P 2 4 A 1 B 3 0 A A

**Air Handler**

- Brand \_\_\_\_\_
- A = Ameristar Brand
- Refrigerant Type \_\_\_\_\_
- 4 = R410A
- Product Family \_\_\_\_\_
- AH = Air Handler Unit
- Nominal Efficiency Rating \_\_\_\_\_
- 4 = 14 SEER
- 6 = 16 SEER
- Blower Type \_\_\_\_\_
- P = PSC
- V = Variable Speed
- E = Constant Torque ECM
- Nominal Capacity \_\_\_\_\_
- BTU/HOUR x 1000
- Major Development Sequence \_\_\_\_\_
- Primary Design / Form Series
- Alphabetic Character "A" through "Z"
- Electric Power Supply Characteristics \_\_\_\_\_
- 1 = 200-230V/1PH/60Hz or 208-230V/1PH/60Hz
- Cabinet Width Size \_\_\_\_\_
- B = 18.5"
- C = 23.5"
- D = 26.5"
- Refrigerant Control \_\_\_\_\_
- 3 = TXV Non-Bleed
- 6 = FCCV (Flow Control/Check Valve)
- Placeholder \_\_\_\_\_
- 0 = Nothing/Blank
- Minor Development Sequence/Series \_\_\_\_\_
- Design Change
- Alphabetic Letter A through Z

**AMERISTAR**  
BY AMERICAN STANDARD HEATING & AIR

1 2 3 4 5 6 7 8 9 10 11 12 13 14 15  
T M M 4 A 0 B 3 6 M 3 1 S A A

**Air Handler - TMM**

- Brand \_\_\_\_\_
- T = Ameristar
- Product Type \_\_\_\_\_
- E = Metal Cabinet
- M = Metal Over Hot Water Heater
- Convertability \_\_\_\_\_
- M = Multi-poise 4-way
- Product Tier \_\_\_\_\_
- 3 = Entry Level Multi-Speed
- 4 = Entry Level Multi-Speed
- 5 = Entry Level High Efficiency
- 6 = Entry Level Variable Speed
- 8 = Entry Level Comm/24V Variable Speed
- Major Design Change \_\_\_\_\_
- No Descriptor \_\_\_\_\_
- 0 = Air Handler / Coil
- Size (Footprint) (W x D) \_\_\_\_\_
- A = 20.5 x 15.0
- B = 18.5 x 21.1 (TEM), 22.0 x 19.0 (TMM)
- C = 23.5 x 21.1
- D = 26.5 x 21.1
- Cooling Size: Air Handler or Coil \_\_\_\_\_
- 0-9 = AH Coil - 1000 BTU's (18, 24, 30, 36, 42, 48, 60)
- Airflow Type & Capability \_\_\_\_\_
- S = Standard Effy, 1-5 - nom. Tonnage (cfm/ton)
- M = Mid Effy Multi-Speed, 1-5 - nom. Tonnage (cfm/ton)
- H = High Effy Variable, 1-5 - nom. Tonnage (cfm/ton)
- V = High Effy Variable, 1-5 - nom. Tonnage (cfm/ton)
- Power Supply \_\_\_\_\_
- 1 = 208-230/1/60
- System Control Type \_\_\_\_\_
- S = Standard - 24 VAC
- C = CLII 13.8 VDC
- D = Dual (24 VAC / CLII 13.8 VDC)
- Minor Design Change \_\_\_\_\_
- Service Digit - Not Orderable \_\_\_\_\_

Ameristar®  
Model Nomenclature

For complete equipment / combination selections, installation instructions and warranty information, please refer to Product Data/Ratings and/or Installers Guides and Limited Warranty Handbooks.



# Model Nomenclature

**AMERISTAR**  
BY AMERICAN STANDARD HEATING & AIR

### Coils

- Brand \_\_\_\_\_  
A = Ameristar Brand
- Refrigerant Type \_\_\_\_\_  
4 = R410A
- Position \_\_\_\_\_  
M = Multi-position (Up/Down/Left/Right)
- Coil Design \_\_\_\_\_  
X = Direct Expansion Evaporator Coil
- Cabinet Width \_\_\_\_\_  
A = 14.5"  
B = 17.5"  
C = 21.0"  
D = 24.5"
- Minimum Capacity \_\_\_\_\_  
BTU/HOUR x 1000
- Maximum Capacity \_\_\_\_\_  
BTU/HOUR x 1000
- Major Design Change \_\_\_\_\_  
Alphabetic Letter A through Z
- Efficiency \_\_\_\_\_  
C = Standard
- Refrigerant Control \_\_\_\_\_  
3 = TXV  
6 = FCCV (Flow Control/Check Valve)
- Coil Circuitry \_\_\_\_\_  
H = Heat Pump  
C = Cooling
- Minor Development Sequence/Series \_\_\_\_\_  
Design Change  
Alphabetic Letter A through Z
- Service Digit \_\_\_\_\_  
Unit Parts Identifier A through Z

A 4 M X C 3 6 4 2 A C 6 H A A

**AMERISTAR**  
BY AMERICAN STANDARD HEATING & AIR

### Packaged Unit

- Refrigerant Type \_\_\_\_\_  
4 = R410A
- Type \_\_\_\_\_  
Y = Gas Electric  
W = Heat Pump Packaged  
T = A/C (Cooling, Electric Heat)
- Unit Functionality & Classification \_\_\_\_\_  
C = Convertible  
H = Dedicated Horizontal
- Brand \_\_\_\_\_  
A = Ameristar Brand
- Family SEER \_\_\_\_\_  
4 = 14
- Nominal Cooling Capacity \_\_\_\_\_  
(BTU/HOUR x 1000)
- Major Modification \_\_\_\_\_  
Major Design Modification A through Z
- Power Supply \_\_\_\_\_  
1 = 230-208V/1/60
- Heating Capacity \_\_\_\_\_  
Capacity (MBTU/H) 0 through 9
- Minor Development Sequence/Series \_\_\_\_\_  
Design Change  
Alphabetic Letter A through Z
- Service Digit \_\_\_\_\_  
Unit Parts Identifier A through Z

4 T C A 4 0 2 4 A 1 0 0 0 A A

ONLINE

# Split System Cooling Single Phase – 1½-5 Tons



**A4AC3  
Air Conditioner**

**Table AMSC-1-A — 13 SEER Split System Air Conditioner**

Model Number	Power Supply	Nom. Cap. Cooling (BTUH)	Uncrated Dimensions (in.)			Shipping Weight (lbs.)	Sound** Rating	MCA*	Max. Fuse*	Line Size (in)	
			H	W	D					OD Gas	OD Liq.
A4AC3018A1000B	208/230/1/60	18,000	29	24	24	152	74	12.0	20	3/4	3/8
A4AC3023A1000C	208/230/1/60	24,000	29	24	24	152	75	13.0	20	3/4	3/8
A4AC3024A1000C	208/230/1/60	24,000	29	26	26	158	74	14.0	20	3/4	3/8
A4AC3029A1000B	208/230/1/60	30,000	29	24	24	152	75	16.0	25	3/4	3/8
A4AC3030A1000C	208/230/1/60	30,000	29	30	30	191	74	16.0	25	3/4	3/8
A4AC3036A1000B	208/230/1/60	36,000	29	30	30	188	75	18.0	30	3/4	3/8
A4AC3042A1000B	208/230/1/60	42,000	29	30	30	205	76	22.0	35	7/8	3/8
A4AC3043A1000B	208/230/1/60	42,000	29	34	34	223	76	22.0	35	7/8	3/8
A4AC3048B1000B	208/230/1/60	48,000	29	34	34	189	76	24.0	40	7/8	3/8
A4AC3060A1000B	208/230/1/60	54,000	37	34	34	251	76	31.0	50	7/8	3/8



**A4AC4  
Air Conditioner**

**Table AMSC-1-B — 14 SEER Split System Air Conditioner**

Model Number	Power Supply	Nom. Cap. Cooling (BTUH)	Uncrated Dimensions (in.)			Shipping Weight (lbs.)	Sound** Rating	MCA*	Max. Fuse*	Line Size (in)	
			H	W	D					OD Gas	OD Liq.
A4AC4018A1000B	208/230/1/60	18,000	29	24	24	152	74	12.0	20	3/4	3/8
A4AC4023A1000C	208/230/1/60	24,000	33	24	24	152	75	13.0	20	3/4	3/8
A4AC4024A1000C	208/230/1/60	24,000	29	26	26	158	74	14.0	20	3/4	3/8
A4AC4030A1000C	208/230/1/60	30,000	29	30	30	191	74	16.0	25	3/4	3/8
A4AC4036A1000C	208/230/1/60	36,000	33	30	30	189	74	18.0	30	3/4	3/8
A4AC4042A1000B	208/230/1/60	42,000	29	34	34	189	76	22.0	35	7/8	3/8
A4AC4048A1000B	208/230/1/60	48,000	29	34	34	189	76	24.0	40	7/8	3/8
A4AC4060A1000B	208/230/1/60	54,000	37	34	34	251	76	31.0	50	7/8	3/8



**A4AC6  
Air Conditioner**

**Table AMSC-1-C — 16 SEER Split System Air Conditioner**

Model Number	Power Supply	Nom. Cap. Cooling (BTUH)	Uncrated Dimensions (in.)			Shipping Weight (lbs.)	Sound** Rating	MCA*	Max. Fuse*	Line Size (in)	
			H	W	D					OD Gas	OD Liq.
A4AC6018A1000A	208/230/1/60	18,000	28.6	23.6	23.6	152	76	12.0	20	3/4	3/8
A4AC6024A1000A	208/230/1/60	24,000	28.6	25.6	25.6	158	76	14.0	25	3/4	3/8
A4AC6030A1000B	208/230/1/60	24,000	28.6	29.8	29.8	188	76	16.0	25	3/4	3/8
A4AC6031A1000A	208/230/1/60	30,000	36.6	29.8	29.8	220	76	17.0	25	3/4	3/8
A4AC6036A1000A	208/230/1/60	36,000	32.6	29.8	29.8	189	76	18.0	30	3/4	3/8
A4AC6037A1000A	208/230/1/60	36,000	36.6	34.3	34.3	246	76	18.0	30	3/4	3/8
A4AC6042A1000A	208/230/1/60	42,000	44.6	34.3	34.3	302	76	21.0	35	7/8	3/8
A4AC6048A1000A	208/230/1/60	48,000	44.6	34.3	34.3	306	76	24.0	40	7/8	3/8
A4AC6060A1000A	208/230/1/60	60,000	44.6	34.3	34.3	327	76	27.0	45	7/8	3/8

Note: Odd-number capacity in the model number, for 2.5 ton and below, indicates smaller-footprint outdoor unit options. The even-number capacity models will have additional indoor matches and ratings options. Check AHRI.org and Comfortsite to verify system match ups. For example: A4AC30**23**A1000A or A4HP40**17**A1000A

\* Information subject to change. Please confirm with current Product Data/Service Facts for current factory production.  
\*\* Rated in accordance with AHRI Standard 270-2008 (Min/Max when applicable).

# Split System Cooling Single Phase – 1½-5 Tons

**Table AMSC-2-A — Features**

	A4AC3	A4AC4	A4AC6
• SEER up to .....	14.00	15.00	16.00
• All-aluminum coil .....	✓	✓	✓
• Scroll compressor for quiet & reliable operation .....	✓	✓	✓
• Small unit footprint for tight spaces (1.5-5 Tons) .....	✓	✓	✓
• Quiet operation   76 dB .....	✓	✓	✓
• Pre-painted steel cabinet & base pan .....	✓	✓	✓
• <b>5-year limited functional parts warranty</b> .....	✓	✓	✓
• <b>10-year functional parts warranty with product registration*</b> .....	✓	✓	✓
• <b>Commercial Applications: Limited Warranty. All other functional parts 1 year</b> .....	✓	✓	✓

\* Registered Limited Warranty terms are available when you register within 60 days of installation. You can register online at [ameristarhvac.com](http://ameristarhvac.com) or by phone at 855-260-2975, otherwise Ameristar's Base Limited Warranty terms will apply. Base Limited Warranty information on specific products can be found on [ASDealerNet.com](http://ASDealerNet.com).

**Table AMSC-2-B — Optional Accessories**

Model Number	Description			
AY28X079 .....	Evap. Defrost Control Kit .....	✓	✓	✓
BAYCCHT301RES .....	Crankcase Heater Kit (Scroll) .....	3.5 - 5.0	3.5 - 5.0	3.5 - 5.0
BAYCCHT302RES .....	Crankcase Heater Kit (Scroll) .....	1.5 - 3.0	1.5 - 3.0	1.5 - 3.0
BAYISLT101 .....	Rubber Isolators .....	✓	✓	✓
BAYLOAM108 .....	External Low Ambient Kit .....	✓	✓	✓
BAYLEGS007 .....	Snow Legs - 7" High (Black) .....	✓	✓	✓
BAYLEGS004 .....	Snow Legs - 4" High (Black) .....	✓	✓	✓
BAYKSKT267 .....	External Start Kit .....	✓	✓	✓
BAYSDEN003 .....	Small Scroll Compressor Enclosures .....	1.5 - 3.0	1.5 - 3.0	1.5 - 3.0
BAYSDEN004 .....	Large Scroll Compressor Enclosures .....	3.5 - 5.0	3.5 - 5.0	3.5 - 5.0

# Split System Heat Pumps Single Phase – 1½-5 Tons



**A4HP4  
Heat Pump**

**Table AMSH-1-A — 14 SEER Split System Heat Pump**

Model Number	Power Supply	Nom. Cap. Cooling (BTUH)	Uncrated Dimensions (in.)			Shipping Weight (lbs.)	Sound** Rating	MCA*	Max. Fuse*	Line Size (in)	
			H	W	D					OD Gas	OD Liq.
A4HP4017A1000B	208/230/1/60	18,000	29	24	24	164	76	12.0	20	¾	⅜
A4HP4018A1000B	208/230/1/60	18,000	29	26	26	167	75	12.0	20	¾	⅜
A4HP4023A1000B	208/230/1/60	24,000	29	26	26	167	76	14.0	25	¾	⅜
A4HP4024A1000B	208/230/1/60	24,000	29	30	30	187	75	14.0	25	¾	⅜
A4HP4030A1000B	208/230/1/60	30,000	29	34	34	207	74	17.0	25	¾	⅜
A4HP4036A1000B	208/230/1/60	36,000	29	34	34	207	76	19.0	30	7/8	⅜
A4HP4042A1000B	208/230/1/60	42,000	29	34	34	227	76	25.0	40	7/8	⅜
A4HP4048A1000B	208/230/1/60	48,000	33	34	34	240	76	25.0	45	7/8	⅜
A4HP4060A1000B	208/230/1/60	54,000	45	34	34	283	76	32.0	50	7/8	⅜



**A4HP6  
Heat Pump**

**Table AMSH-1-B — 16 SEER Split System Heat Pump**

Model Number	Power Supply	Nom. Cap. Cooling (BTUH)	Uncrated Dimensions (in.)			Shipping Weight (lbs.)	Sound** Rating	MCA*	Max. Fuse*	Line Size (in)	
			H	W	D					OD Gas	OD Liq.
A4HP6018A1000A	208/230/1/60	18,000	29	26	26	167	76	12.0	20	¾	⅜
A4HP6024A1000A	208/230/1/60	24,000	29	30	30	187	76	14.0	25	¾	⅜
A4HP6030A1000A	208/230/1/60	30,000	37	34	34	245	76	17.0	25	¾	⅜
A4HP6036A1000A	208/230/1/60	36,000	37	34	34	246	76	18.0	30	¾	⅜
A4HP6042A1000A	208/230/1/60	42,000	45	34	34	277	76	24.0	40	7/8	⅜
A4HP6048A1000A	208/230/1/60	48,000	45	34	34	300	76	26.0	40	7/8	⅜
A4HP6060A1000A	208/230/1/60	54,000	45	34	34	300	76	32.0	50	7/8	⅜

Note: Odd-number capacity in the model number, for 2.5 ton and below, indicates smaller-footprint outdoor unit options. The even-number capacity models will have additional indoor matches and ratings options. Check AHRI.org and Comfortsite to verify system match ups. For example: A4AC30**23**A1000A or A4HP40**17**A1000A

\* Information subject to change. Please confirm with current Product Data/Service Facts for current factory production.

\*\* Rated in accordance with AHRI Standard 270-2008 (Min/Max when applicable).

# Split System Heat Pumps Single Phase – 1½-5 Tons

**Table AMSH-2-A — Features**

	A4HP4	A4HP6
• SEER up to .....	15.00	16.00
• HSFP up to.....	8.5	9.5
• All-aluminum coil .....	✓	✓
• Scroll compressor for quiet & reliable operation.....	✓	✓
• Small unit footprint for tight spaces (1.5-5 Tons) .....	✓	✓
• Quiet operation   76 dB .....	✓	✓
• Pre-painted steel cabinet & base pan.....	✓	✓
• <b>5-year functional parts limited warranty</b> .....	✓	✓
• <b>10-year functional parts warranty with product registration*</b> .....	✓	✓
• <b>Commercial Applications: Limited Warranty. All other functional parts 1 year</b> .....	✓	✓

\* Registered Limited Warranty terms are available when you register within 60 days of installation. You can register online at [ameristarvac.com](http://ameristarvac.com) or by phone at 855-260-2975, otherwise Ameristar's Base Limited Warranty terms will apply. Base Limited Warranty information on specific products can be found on [ASDealerNet.com](http://ASDealerNet.com).

**Table AMSH-2-B — Optional Accessories**

Model Number	Description		
AY28X079 .....	Evap. Defrost Control Kit.....	✓	✓
BAYCCHT301RES.....	Crankcase Heater Kit (Scroll) .....	3.5 - 5.0	3.5 - 5.0
BAYCCHT302RES.....	Crankcase Heater Kit (Scroll) .....	1.5 - 3.0	1.5 - 3.0
BAYISLT101 .....	Rubber Isolators .....	✓	✓
BAYLOAM108.....	External Low Ambient Kit .....	✓	✓
BAYLEGS007.....	Snow Legs - 7" High (Black).....	✓	✓
BAYLEGS004.....	Snow Legs - 4" High (Black).....	✓	✓
BAYKSKT267.....	External Start Kit .....	✓	✓
BAYSDEN003 .....	Small Scroll Compressor Enclosures .....	1.5 - 3.0	1.5 - 3.0
BAYSDEN004 .....	Large Scroll Compressor Enclosures .....	3.5 - 5.0	3.5 - 5.0

# Split System Air Handlers Single Phase 1½-5 Tons



**A4AH4  
Multi-position  
Air Handlers**

**Table AMAH-1-A — R-410A 14 SEER Multi-position Air Handlers 208-230/1/60**

Model Number	Cooling Capacity (Btuh)	Uncrated Dimensions (in.)			Shipping Weight (lbs.)	Supply Opening	Return Opening	Refrigerant Control	Filter Sizes	Line Size (in)	
		H	W	D						Gas	Liquid
A4AH4P18A1B60B	1.5	45.02	18.50	21.13	116	16.5 x 12.15	16.75 x 18.75	FCCV <sup>①</sup>	③	¾	⅜
A4AH4P24A1B60B	2.0	45.02	18.50	21.13	116	16.5 x 12.15	16.75 x 18.75	FCCV <sup>①</sup>	③	¾	⅜
A4AH4P30A1B60B	2.5	45.02	18.50	21.13	116	16.5 x 12.15	16.75 x 18.75	FCCV <sup>①</sup>	③	¾	⅜
A4AH4P36A1B30B	3.0	45.02	18.50	21.13	116	16.5 x 12.15	16.75 x 18.75	TXVNB <sup>②</sup>	③	¾	⅜
A4AH4P37A1C30B	3.0	51.27	23.50	21.13	145	21.5 x 12.15	21.75 x 18.75	TXVNB <sup>②</sup>	③	7/8	⅜
A4AH4E42A1C30B	3.5	51.27	23.50	21.13	145	21.5 x 12.15	21.75 x 18.75	TXVNB <sup>②</sup>	③	7/8	⅜
A4AH4E48A1C30B	4.0	51.27	23.50	21.13	145	21.5 x 12.15	21.75 x 18.75	TXVNB <sup>②</sup>	③	7/8	⅜
A4AH4E60A1C30B	5.0	51.27	23.50	21.13	145	21.5 x 12.15	21.75 x 18.75	TXVNB <sup>②</sup>	③	7/8	⅜

- ① 1.5, 2, and 2.5 ton air handlers shipped with a Fixed Metering Device (Flow Control Check Valve - FCCV). Some rated combinations require a TXV kit, ordered separately. See the coil Installer's Guide for Orifice and TXV matches.
- ② Start Kit may be required on outdoor unit.
- ③ Filter not supplied. Remote filter required.



**A4AH6  
Multi-position  
Air Handlers**

**Table AMAH-1-B — R-410A 16 SEER Multi-position Air Handlers 208-230/1/60**

Model Number	Cooling Capacity (Btuh)	Uncrated Dimensions (in.)			Shipping Weight (lbs.)	Supply Opening	Return Opening	Refrigerant Control	Filter Sizes	Line Size (in)	
		H	W	D						Gas	Liquid
A4AH6E19A1B30A	18000	45	18.5	21	116	16.5 x 12.15	16.75 x 18.75	TXV	①	¾	⅜
A4AH6E31A1B30A	30000	46.8	18.5	21	145	16.5 x 12.15	16.75 x 18.75	TXV	①	¾	⅜
A4AH6E43A1C30A	42000	51.3	23.5	21	155	21.5 x 12.15	21.75 x 18.75	TXV	①	7/8	⅜
A4AH6E49A1C30A	48000	55.9	23.5	21	185	21.5 x 12.15	21.75 x 18.75	TXV	①	7/8	⅜
A4AH6E61A1C30A	60000	55.9	23.5	21	185	21.5 x 12.15	21.75 x 18.75	TXV	①	7/8	⅜
A4AH6V24A1B30A	24000	46.8	18.5	21	126	16.5 x 12.15	16.75 x 18.75	TXV	①	¾	⅜
A4AH6V30A1B30A	30000	46.8	18.5	21	126	16.5 x 12.15	16.75 x 18.75	TXV	①	¾	⅜
A4AH6V36A1C30A	36000	51.3	23.5	21	155	21.5 x 12.15	21.75 x 18.75	TXV	①	7/8	⅜
A4AH6V42A1C30A	42000	51.3	23.5	21	155	21.5 x 12.15	21.75 x 18.75	TXV	①	7/8	⅜
A4AH6V48A1D30A	48000	53.9	26.5	21	181	24.5 x 12.15	24.75 x 18.75	TXV	①	7/8	⅜
A4AH6V60A1D30A	60000	53.9	26.5	21	181	24.5 x 12.15	24.75 x 18.75	TXV	①	7/8	⅜
A4AH6V48A1C30B	48000	55.9	23.5	21	185	21.5 x 12.15	21.75 x 18.75	TXV	①	7/8	⅜
A4AH6V60A1C30B	60000	55.9	23.5	21	185	21.5 x 12.15	21.75 x 18.75	TXV	①	7/8	⅜

- ① Filter not supplied. Remote filter required

Note: These Air Handlers are A.H.R.I. certified with various Split System Air Conditioners and Heat Pumps (AHRI STANDARD 210/240). Refer to the Split System Outdoor Unit Product Data Guides for performance data.

# Split System Air Handlers

## Single Phase 1½-5 Tons

**Table AMAH-2-A — Features**

	A4AH4	A4AH6
• Multi-Position Upflow / Downflow,* Horizontal Left /Right.....	✓	✓
• Unpainted galvanized metal cabinet with captured foil face insulation .....	✓	✓
• R-4.2 Insulating Value .....	✓	✓
• Wipeable interior design.....	✓	✓
• 2% or less air leakage.....	✓	✓
• All Aluminum Coil with Enhanced Patented Coil Fin.....	✓	✓
• Factory installed orifice with mechanical connections on both sides.....	1.5-2.5	—
• Factory installed R-410A Thermal Expansion Valve with mechanical connections on both sides.....	3.0-5.0	✓
• Optional field installed TXV kits with mechanical fittings for higher performance.....	1.5-2.5	—
• PSC Motor .....	1.5-3.0	—
• Constant Torque ECM Motor .....	3.5-5.0	A4AH6E
• VSPD ECM Motor .....	—	A4AH6V
• Electric Heaters with polarized plug connections (sold as accessory & field installed) .....	✓	✓
• Low Voltage Pigtail Connections .....	✓	✓
• Fused 24V Power.....	✓	✓
• Maximum Width 23.5".....	✓	—
• Compact depth.....	21"	21"
• Draw through design .....	✓	✓
• Approved for manufactured/mobile home use .....	✓	✓
• <b>5-year functional parts limited warranty/No Registration Required</b> .....	✓	✓
• <b>10-year functional parts warranty with product registration*</b> .....	✓	✓
• <b>Commercial Applications: Limited Warranty. All other functional parts 1 year</b> .....	✓	✓

\* Registered Limited Warranty terms are available when you register within 60 days of installation. You can register online at ameristarthvac.com or by phone at 855-260-2975, otherwise Ameristar's Base Limited Warranty terms will apply. Base Limited Warranty information on specific products can be found on ASDealerNet.com.

**Table AMAH-2-B — Optional Accessories**

Model Number	Description	Matches Cabinet Size(s)	A4AH4	A4AH6
BAYTEMSPPFG1 .....	Supply Duct Flange Kit.....	18.5" and 23.5".....	✓	✓
BAYSPEKT201A .....	Single Point Power Entry Kit.....	18.5" and 23.5".....	✓	✓
TAYBASE185.....	Air Handler Downflow Sub-Bases .....	18.5" .....	✓	✓
TAYBASE235 (TAYBASE100) ..	Air Handler Downflow Sub-Bases .....	23.5" .....	✓	✓
BAYTEMDFKT1A.....	Downflow Condensate Management Kit.....	23.5" ①.....	✓	✓
BAYAHEMIKIT001 .....	Air handler Electronic Noise Kit used on Variable Speed Blower Motor .....	.....	✓	✓
TEMBRKSEALKT01A.....	Breaker Seal Kit for use with BAYHTR15 4kW 20 kW Heaters .....	.....	✓	✓
BAYSF1185AAA.....	Slim Fit Filter Box Kit .....	18.5" .....	✓	✓
BAYSF1235AAA.....	Slim Fit Filter Box Kit .....	23.5" .....	✓	✓
FLRSF1185.....	1" Slim Fit Replacement Filter, 17.75"x19.75", Qty 12 .....	18.5" .....	✓	✓
FLRSF1235.....	1" Slim Fit Replacement Filter, 22.75"x19.75", Qty 12.....	23.5" .....	✓	✓
BAY4TXV1830A.....	R-410A TXV kit.....	.....	1½-2½/2	—
BAYATXV1836B .....	R-22 TXV conversion kit.....	.....	1½-2½/2	—
BAYATXV4248B .....	R-22 TXV conversion kit.....	.....	3-4	—
BAYATXV6161B .....	R-22 TXV conversion kit.....	.....	5	—
BAY6TXV2442A .....	R-22 conversion kit for 2-3.5 Ton models.....	.....	—	✓
BAY6TXV4860A.....	R-22 conversion kit for 4-5 Ton D models .....	.....	—	✓
BAY6TXV6161C.....	R-22 conversion kit for 4-5 Ton C models .....	.....	—	✓

① Downflow condensate management kit is required for 5 Ton downflow models.

# Heaters for Split System Air Handlers

**Table AMAH-3-A — BAYHTR15 — Heater, Standard, for A4AH4 Air Handlers**

Heater Model Number	Capacity @ 240 Volts		Capacity @ 208 Volts		Rated Voltage	Control Stages	Number of Heater Racks	Number of Circuits	Heater Amps per Circuit		Contains Circuit Breakers
	kW	BTUH	kW	BTUH					208 Volts	240Volt	
BAYHTR1504BRKC	3.84	13100	2.88	9800	208/240/1/60	1	1	1	13.8	16	Yes
BAYHTR1504LUGB	3.84	13100	2.88	9800	208/240/1/60	1	1	1	13.8	16	No
BAYHTR1505BRKC	4.80	16400	3.60	12300	208/240/1/60	1	1	1	17.3	20	Yes
BAYHTR1505LUGB	4.80	16400	3.60	12300	208/240/1/60	1	1	1	17.3	20	No
BAYHTR1508BRKC	7.68	26200	5.76	19700	208/240/1/60	1	1	1	27.7	32	Yes
BAYHTR1508LUGB	7.68	26200	5.76	19700	208/240/1/60	1	1	1	27.7	32	No
BAYHTR1510BRKC	9.60	32800	7.20	24600	208/240/1/60	1	2	1	34.6	40	Yes
BAYHTR1510LUGB	9.60	32800	7.20	24600	208/240/1/60	1	2	1	34.6	40	No
BAYHTR1515BRKB	14.4	49200	10.8	36900	208/240/1/60	2	3	2	51.9	60	Yes
BAYHTR1516BRKA	14.4	49200	10.8	36900	208/240/1/60	2	3	2	51.9	60	Yes
BAYHTR1517BRKA	14.4	49200	10.8	36900	208/240/1/60	2	3	2	51.9	60	Yes
BAYHTR1519BRKB	19.2	65500	14.4	49200	208/240/1/60	2	4	2	69.2	80	Yes
BAYHTR1520BRKB	19.2	65500	14.4	49200	208/240/1/60	2	4	2	69.2	80	Yes
BAYHTR1521BRKB	19.2	65500	14.4	49200	208/240/1/60	2	4	2	69.2	80	Yes
BAYHTR1522BRKA	19.2	65500	14.4	49200	208/240/1/60	2	4	2	69.2	80	Yes
BAYHTR1523BRKA	19.2	65500	14.4	49200	208/240/1/60	2	4	2	69.2	80	Yes
BAYHTR1525BRKA	24.0	81900	18.0	61600	208/240/1/60	2	4	2	86.4	100	Yes

**Table AMAH-3-B — BAYHTR35 — Heater, 3-Phase, for A4AH4 Air Handlers**

Heater Model Number	Capacity @ 240 Volts		Capacity @ 208 Volts		Rated Voltage	Control Stages	Number of Heater Racks	Number of Circuits	Heater Amps per Circuit		Contains Circuit Breakers
	kW	BTUH	kW	BTUH					208 Volts	240Volt	
BAYHTR3510LUGC	9.60	32800	7.20	24600	208/240/3/60	1	3	1	20.0	23.1	No
BAYHTR3515LUGC	14.4	49200	10.8	36900	208/240/3/60	1	3	1	30.0	34.6	No
BAYHTR3517LUGA	14.4	49200	10.8	36900	208/240/3/60	1	3	1	30.0	34.6	No

BRK = Contains circuit breakers

LUG = Lug connections

① 3-Phase - W1 and W2 must be jumpered at low voltage connector

**Table AMAH-3-C — A4AH4 Air Handler and Heater matches**

AIR HANDLER	HEATER MATRIX				
	HEATER MODEL NUMBER				
<b>MODEL NUMBER</b>	BAYHTR1504BRKC BAYHTR1504LUGB 3.84 Kw BK BAYHTR1505BRKC BAYHTR1505LUGB 4.80 Kw BK	BAYHTR1508BRKC BAYHTR1508LUGB 7.68 Kw BK BAYHTR1510BRKC BAYHTR1510LUGB 9.60 Kw BK	BAYHTR1517BRKA BAYHTR3517LUGA 14.40 Kw BK	BAYHTR1523BRKA 19.20 Kw BK	BAYHTR1525BRKA 24.00 Kw BK
A4AH4P18A1B60A		Y	--	--	--
A4AH4P24A1B60A	Y				
A4AH4P30A1B60A		Y	Y	--	--
A4AH4P36A1B30A	Y				
A4AH4P37A1C30A		Y	Y	Y	--
A4AH4E42A1C30A	Y		Y	Y	Y
A4AH4E48A1C30A	Y		Y	Y	Y
A4AH4E60A1C30A	Y		Y	Y	Y
A4AH6E19A1B30A	Y		Y		
A4AH6V24A1B30A					
A4AH6V30A1B30A	Y		Y		
A4AH6E31A1B30A					
A4AH6V36A1C30A					
A4AH6V42A1C30A	Y		Y	Y	
A4AH6E43A1C30A					
A4AH6E49A1C30A					
A4AH6E61A1C30A			Y		
A4AH6V48A1C30B	Y		Y	Y	Y
A4AH6V60A1C30B					

For complete equipment / combination selections, installation instructions and warranty information, please refer to Product Data/Ratings and/or Installers Guides and Limited Warranty Handbooks.



# TMM Wall, Stud, or Over the Water Heater Mount Air Handlers Single Phase 1½-3 Tons



**Table AMAH-4-A — TMM5 R-410A Wall, Stud, or Over the Water Heater Mount Air Handler 208-230/1/60, ECM Motor, Factory installed R-410A TXV, all aluminum coil, Cooling & Limited Heating**

Unit Model No.	Cooling Capacity (Btuh)	Dimensions (in.) H x W x D	Shipping Weight (lbs.)	Supply Opening	Filter Sizes	Line Size	
						Gas	Liquid
TMM5B0A24M21SA	24000	36.5 x 20.5 x 15.0	93	15 x 9.5	①	3/4	3/8
TMM5B0B30M21SA	30000	39.5 x 22.0 x 19.0	115	19 x 9.5	①	3/4	3/8
TMM5B0B36M31SA	36000	39.5 x 22.0 x 19.0	115	19 x 9.5	①	3/4	3/8

**Table AMAH-4-B — TMM4 R-410A Wall, Stud, or Over the Water Heater Mount Air Handler 208-230/1/60, PSC Motor, Factory installed R-410A orifice, all aluminum coil, Cooling & Heating**

Unit Model No.	Cooling Capacity (Btuh)	Dimensions (in.) H x W x D	Shipping Weight (lbs.)	Supply Opening	Filter Sizes	Line Size	
						Gas	Liquid
TMM4B0A18S21SA	18000	36.5 x 20.5 x 15.0	97	15 x 9.5	1	3/4	3/8
TMM4B0A24S21SA	24000	36.5 x 20.5 x 15.0	97	15 x 9.5	1	3/4	3/8
TMM4B0B30S21SA	30000	39.5 x 22.0 x 19.0	119	19 x 9.5	1	3/4	3/8
TMM4B0B36S31SA	36000	39.5 x 22.0 x 19.0	119	19 x 9.5	1	3/4	3/8

① Filter not supplied. Remote filter required.

**Table AMAH-4-C — Features**

	TMM5B 2-3	TMM4B 1-1/2-3
• Painted metal cabinet with captured foil face insulation .....	✓	✓
• 2% or less air leakage.....	✓	✓
• All aluminum coil.....	✓	✓
• Direct drive, multi speed ECM blower motor - Constant torque ECM (electronically commutated motor) with fan-off time delay programming .....	✓	—
• PSC Motor .....	—	✓
• Limited HP matched system ratings .....	—	✓
• R-4.2 Insulating Value .....	✓	✓
• Upflow only .....	✓	✓
• Front return option .....	✓	✓
• High Efficiency Copper / Aluminum Coil .....	✓	✓
• Electric Heaters with polarized plug connections (sold as accessory).....	✓	✓
• R-410A Thermal Expansion Valve.....	✓	—
• Low Voltage Pigtail Connections.....	✓	✓
• Single Color .....	✓	✓
• Fused 24V Power.....	✓	✓
• Wipeable interior design.....	✓	✓
• Maximum Height 39.5" .....	✓	✓
• Maximum Width 22" .....	✓	✓
• Compact 22" depth.....	✓	✓
• Optional R-22 and R-410A TXV kits (sold as accessory) .....	✓	✓
• <b>10-year functional parts warranty with product registration</b> .....	✓	✓
• <b>Commercial Applications: Limited Warranty. All other functional parts 1 year</b> .....	✓	✓

\* Registered Limited Warranty terms are available when you register within 60 days of installation. You can register online at ameristarhvac.com or by phone at 855-260-2975, otherwise Ameristar's Base Limited Warranty terms will apply. Base Limited Warranty information on specific products can be found on ASDealerNet.com.

# TMM Wall, Stud, or Over the Water Heater Mount Air Handlers Single Phase 1½-3 Tons

**Table AMAH-5-A — Optional Accessories**

Model Number	Description	TMM5B	TMM4B
4AYTXVH3G2436A.....	R-410A TXV kit 1-1/2 to 3 ton .....	—	✓
2AYTXVH3G2436A.....	R-22 TXV conversion kit 1-1/2 to 3 ton .....	✓	✓
BAYFRTLLOUPNL20....	Front louver panel 20.5" width.....	—	✓
BAYFRTLLOUPNL22....	Front louver panel 22.0" width.....	✓	✓
BAYTMMWALLPNL1...	Return air / service wall panel (Qty 20).....	✓	✓

## Heaters for TMM Split System Air Handlers

**Table AMAH-5-B — BAYHTRM — Heater, Standard, for TMM Air Handlers**

Heater Model Number	Capacity@ 240 Volts		Capacity@ 208 Volts		Rated Voltage	Control Stages	Number of Heater Racks	Number of Circuits	Heater Amps per Circuit		Contains Circuit Breakers
	kW	BTUH	kW	BTUH					208 Volts	240Volt	
BAYHTRM505BRK	5.0	17100	3.8	12800	208/240/1/60	1	1	1	18	20.8	Yes
BAYHTRM508BRK	7.5	25600	5.6	19200	208/240/1/60	1	1	1	27.1	31.2	Yes
BAYHTRM510BRK	10.0	34100	7.5	25600	208/240/1/60	1	2	1	36.1	41.7	Yes

# Split System – Cased Heat Pump and Cooling Coils



**4MXC  
Multi-Position  
Cased Coils**

**Table AMCOIL-1-A — Aluminum Single Stage Cased Coil (Upflow/Downflow/Horizontal) R-410A Refrigerant**

Model Number	Cooling Capacity Range (Tons)	Coil Type	Refrigerant Control	Outlet Dim. (in.) W/H x D	Overall Dim. (in.) H x W x D	Shipping Weight (lbs.)	Line Size OD Gas	Line Size OD Liq.
4MXCA003AC6HCB	1.5 - 3.0	A	FCCV <sup>①</sup>	13 x 19	20 x 14.5 x 21	51	3/4	3/8
4MXCB004AC6HCB	1.5 - 3.0	A	FCCV <sup>①</sup>	16 x 19	20 x 17.5 x 21	55	3/4	3/8
4MXCC005AC6HCB	2.5 - 3.0	A	FCCV <sup>①</sup>	19 1/2 x 19	20 x 21 x 21	59	3/4	3/8
4MXCB006AC6HCB	3.0 - 4.0	A	FCCV <sup>①</sup>	16 x 19	26 x 17.5 x 21	66	7/8	3/8
4MXCC007AC6HCB	3.0 - 4.0	A	FCCV <sup>①</sup>	19 1/2 x 19	26 x 21 x 21	70	7/8	3/8
4MXCD008AC6HCB	3.5 - 4.0	A	FCCV <sup>①</sup>	23 x 19	26 x 24.5 x 21	74	7/8	3/8
4MXCC009AC3HCB	3.5 - 5.0	A	FCCV <sup>①</sup>	19 1/2 x 19	30 x 21 x 21	91	7/8	3/8
4MXCD010AC3HCB	3.5 - 5.0	A	FCCV <sup>①</sup>	23 x 19	30 x 24.5 x 21	95	7/8	3/8
4MXCB016AC6HCB <sup>②</sup>	3.0 - 4.0	A	FCCV <sup>①</sup>	16 x 19	30 x 17.5 x 21	82	7/8	3/8
4MXCC017AC6HCB <sup>②</sup>	3.0 - 4.0	A	FCCV <sup>①</sup>	19 1/2 x 19	30 x 21 x 21	88	7/8	3/8
4MXCD018AC6HCB <sup>②</sup>	3.5 - 4.0	A	FCCV <sup>①</sup>	23 x 19	30 x 24.5 x 21	92	7/8	3/8

① All coils shipped with a Fixed Metering Device (Flow Control Check Valve - FCCV). Some rated combinations require a TXV kit, ordered separately. See the coil Installer's Guide for Orifice and TXV matches.

② Enhanced models for use in heating.  
Will be transitioning to unpainted cabinet during 2022.

**Table AMCOIL-1-B — Features**

	4MXC
• All aluminum coil.....	✓
• 100% foil lined insulation.....	✓
• Factory installed fixed orifice. Additional orifices supplied.....	✓
• Optional accessory TXV Kit with mechanical fittings available for higher performance ratings ①.....	✓
• Easy case attachment to furnace.....	✓
• Upflow application.....	✓
• Downflow application.....	✓
• Horizontal Right application.....	✓
• Horizontal Left application.....	✓
• Single sloped non-corrosive drain pan.....	✓
• Unpainted galvanized steel cabinet.....	✓
• <b>10-year limited warranty on coil, &amp; all other functional parts, with registration*</b> .....	✓
• <b>Commercial Applications: Limited Warranty Coil and Parts 1 year</b> .....	✓

① Reference AHRI ratings to find correct TXV kit or reference Product Data for additional information.

\* Registered Limited Warranty terms are available when you register within 60 days of installation. You can register online at [ameristarhvac.com](http://ameristarhvac.com) or by phone at 855-260-2975, otherwise Ameristar's Base Limited Warranty terms will apply. Base Limited Warranty information on specific products can be found on [ASDealerNet.com](http://ASDealerNet.com).

# Split System – Cased Heat Pump and Cooling Coils

**Table AMCOIL-2-A — Refrigerant TXV Kits for 4MXC Coils**

Tons	R-410A TXV Kit (If required)	R-22 TXV Kit (If required)
1.5-3.0	4AYTXVH3G2436A	2AYTXVH3G2436A
3.5-4.0	4AYTXVH3G4248A	2AYTXVH3G4248A
5	4AYTXVH3G6000A	2AYTXVH3G6000A

Note: Additional R-22 Kit combinations can be found in the Accessories section.

**Table COIL-2-B — Orifice kit table for 4MXC coils**

Outdoor Unit Capacity (Tons)	Orifice Size (R410A)	Orifice Kit	Orifice Size (R22)	Orifice Kit
1.5	0.052	MAYORIACHP0052B	0.052	MAYORIACHP0052B
2	0.058	MAYORIACHP0058B	0.058	MAYORIACHP0058B
2.5*	0.063 / 0.065	MAYORIACHP0063B / 065A	0.065	MAYORIACHP0065A
3	0.070	MAYORIACHP0070B	0.072	MAYORIACHP0072B
3.5	0.075	MAYORIACHP0075B	0.078	MAYORIACHP0078B
4	0.083	MAYORIACHP0083B	0.088	MAYORIACHP0088B
5	0.090	MAYORIACHP0090B	0.096	MAYORIACHP0096B

Note: Orifice size needed for system combination may not be pre-installed. See Table 1 in coil Installation Manual for pre-installed size.

\* Necessary Orifice sizes varies for this tonnage. See Table 3 in coil Installation Manual.

Ameristar<sup>®</sup>  
Coils

## A801X - Single Stage, ECM



**A801X  
Gas Furnace**

**Table AMFUR-1-A — A801X, Constant Torque ECM, 1 stage, 80% AFUE Gas Furnace**

Model Number	CA Low NOx Model Number <sup>②</sup>	Input (BTUH)	AFUE	Flue Size (in.)	Ignition Device	Uncrated Dimensions (in.)			Shipping Weight (lbs.)	Max. Fuse*	Filter Sizes
						H	W	D			
A801X026AM2SCA	A801X026AM2TCA	26,000	80.0	4	①	34	14.5	28.75	102	15	14x25x1
A801X040BM2SCA	A801X040BM2TCA	40,000	80.0	4	①	34	14.5	28.75	102	15	14x25x1
A801X040AM3SCA	A801X040AM3TCA	40,000	80.0	4	①	34	17.5	28.75	128	15	16x25x1
A801X060BM4SCA	A801X060BM4TCA	60,000	80.0	4	①	34	17.5	28.75	132	15	16x25x1
A801X080BM4SCA	A801X080BM4TCA	80,000	80.0	4	①	34	17.5	28.75	137	15	16x25x1
A801X080CM5SCA	A801X080CM5TCA	80,000	80.0	4	①	34	21	28.75	142	15	20x25x1
A801X100CM5SCA	A801X100CM5TCA	100,000	80.0	4	①	34	21	28.75	144	15	20x25x1
A801X120DM5SCA	A801X120DM5TCA	120,000	80.0	4	①	34	24.5	28.75	160	15	24x25x1

① Silicon Nitride Igniter.

② These models comply with California 40 ng/J Low NOx regulations.

\* Information subject to change. Please confirm with current Product Data/Service Facts for current factory production.

## A801X High Altitude Kits

**Table AMFUR-1-B — High Altitude Pressure Switch A801X Furnaces**

Model Number	Description	Used With	Shipping Weight
BAYSWT14AHALTB	1 Switch	A801X080CM5SCA <sup>①</sup> , A801X100CM5SCA <sup>①</sup>	2
BAYSWT15AHALTA	1 Switch	A801X060BM3SCA <sup>①</sup> , A801X060BM4SCA <sup>①</sup> , A801X080BM4SCA <sup>①</sup>	2
BAYSWT20AHALTA	1 Switch	A801X026AM2SCA <sup>①</sup>	2
BAYSWT21AHALTA	1 Switch	A801X040AM3SCA <sup>①</sup> , A801X040BM2SCA <sup>①</sup>	2

Note: A801X120DM5 does not require a high altitude pressure switch kit.

① SAC and TAC or later

# A801X - Single Stage, ECM

**Table AMFUR-2-A — Features**

	A801X
• AFUE .....	80.00
• 34" cabinet height .....	✓
• 4-Way Poise (Upflow, Downflow, Horizontal Left, Horizontal Right) .....	✓
• Tubular Aluminized Steel Heat Exchanger .....	✓
• FER compliant .....	✓
• Gas can enter either side of cabinet .....	✓
• Multiple furnace venting options in each poise .....	✓
• Integrated Furnace Control board with digital configuration, status, and fault codes .....	✓
• Alpha-numeric diagnostic codes .....	✓
• Adjustable blower off delay for heating and cooling .....	✓
• Meets requirements for 1.4% cabinet air leakage .....	✓
• Front service access with easily accessible burners, sensors, orifices, switches, and other components .....	✓
• Cabinet has no knockouts - Rubber and plastic plugs come installed from factory .....	✓
• Multiple venting options - Every model, every size will offer two venting options .....	✓
• Longer IFC wire harnesses allow door to be removed without disconnecting the harness .....	✓
• Alternate bottom/left/right return air (except downflow) .....	✓
• Bottom panel .....	✓
• Multi-port in shot burners .....	✓
• Silicon Nitride 120V hot surface igniter .....	✓
• Direct drive, 9 Speed Constant Torque ECM Blower Motor .....	✓
• Heavy gauge reinforced wrap-around steel cabinet .....	✓
• Service diagnostics with faults reported on IFC board .....	✓
• Manual reset flame roll out switches .....	✓
• Slide out blower assembly on full-length rails .....	✓
• Side return duct starter tabs .....	✓
• Multiple heating blower speeds .....	✓
• <b>5-year functional parts limited warranty/No Registration Required</b> .....	✓
• <b>10-year functional parts warranty with product registration*</b> .....	✓
• <b>Commercial Applications: Limited Warranty Heat exchangers 20 years. All other functional parts 1 year</b> .....	✓

\* Registered Limited Warranty terms are available when you register within 60 days of installation. You can register online at ameristarhvac.com or by phone at 855-260-2975, otherwise Ameristar's Base Limited Warranty terms will apply. Base Limited Warranty information on specific products can be found on ASDealerNet.com.

**Table AMSC-2-B — Optional Accessories**

Model Number	Description	Shipping Weight	
BAYLPSS400B .....	LP Kit with Stainless Steel Burners .....	3 .....	(except 026)
BAYLPSS410A .....	LP Kit with Stainless Steel Burners .....	3 .....	A801X026
BAYHANG .....	Horizontal hanging kit .....	2 .....	✓
BAYSF1165A .....	1" SlimFit Box with MERV 4 Filter (side return) .....	5 .....	✓
BAYFLTR203 .....	Horizontal Filter Kit for B Cabinets .....	5 .....	✓
BAYFLTR204 .....	Horizontal Filter Kit for C Cabinets .....	5 .....	✓
BAYFLTR205 .....	Horizontal Filter Kit for D Cabinets .....	5 .....	✓
BAYVENT600A① .....	Internal venting kit .....	11 .....	✓
BAYVENT800B .....	Masonry Chimney Vent Kit .....	11 .....	✓
PIP02095 .....	U fitting for gas piping .....	1 .....	✓
BAYLIFTB .....	Dual return kit. B cabinet size extension .....	8 .....	✓
BAYLIFTC .....	Dual return kit. C cabinet size extension .....	9 .....	✓
BAYLIFTD .....	Dual return kit. D cabinet size extension .....	9 .....	✓
BAYBASE205 .....	Downflow subbase .....	8 .....	✓
BAYFLTR206 .....	Filter Access Door Kit (Downflow only) .....	2 .....	✓
BAYSF1165 .....	16x20 1" side return filter rack .....		✓
BAYSF1255 .....	16x25 1" side return filter rack (bottom return for 17.5" cabinets) .....		✓
BAYBURNERSS .....	Stainless steel natural gas burner kit .....		✓

① Compatible with B, C, and D width cabinets.

**Comfort Controls — See Comfort Controls/Zone Sensors Section**

## A951X - Single Stage, ECM



**A951X**  
Gas Furnace

**Table AMFUR-3-A — A951X Constant Torque ECM, 1 Stage, 95-96% AFUE, Upflow Gas Furnace**

Model Number	Input (BTUH)		ICS AFUE <sup>②</sup>	Flue Size (in.)	Ignition Device	Uncrated Dimensions (in.)			Shipping Weight (lbs.)	Max. Fuse*	Filter Sizes
	1st Stage	2nd Stage				H	W	D			
A951X040BU3SAB	40,000		96.0 <sup>③</sup>	2, 3, 4	①	34	17.5	28.75	122	15	16x25x1
A951X060BU4SAB	60,000		96.0 <sup>③</sup>	2, 3, 4	①	34	17.5	28.75	130	15	16x25x1
A951X080BU4SAB	80,000		96.0 <sup>③</sup>	2, 3, 4	①	34	17.5	28.75	135	15	16x25x1
A951X080CU5SAB	80,000		96.0 <sup>③</sup>	2, 3, 4	①	34	21	28.75	149	15	20x25x1
A951X100CU5SAB	100,000		95.0 <sup>③</sup>	2, 3, 4	①	34	21	28.75	155	15	20x25x1
A951X120DU5SAB	120,000		95.0 <sup>③</sup>	3, 4	①	34	24.5	28.75	167	15	24x25x1

**Table AMFUR-3-B — A951X Constant Torque ECM, 1 Stage, 95-96% AFUE, Downflow Gas Furnace**

Model Number	Input (BTUH)		ICS AFUE <sup>②</sup>	Flue Size (in.)	Ignition Device	Uncrated Dimensions (in.)			Shipping Weight (lbs.)	Max. Fuse*	Filter Sizes
	1st Stage	2nd Stage				H	W	D			
A951X040BD3SAB	40,000		96.0 <sup>③</sup>	2, 3, 4	①	34	17.5	28.75	122	15	(2) 14x20x1
A951X060BD3SAB	60,000		96.0 <sup>③</sup>	2, 3, 4	①	34	17.5	28.75	127	15	(2) 14x20x1
A951X080BD4SAB	80,000		95.0 <sup>③</sup>	2, 3, 4	①	34	17.5	28.75	135	15	(2) 14x20x1
A951X100CD5SAB	100,000		96.0 <sup>③</sup>	2, 3, 4	①	34	21	28.75	155	15	(2) 16x20x1
A951X120DD5SAB	120,000		95.0 <sup>③</sup>	3, 4	①	34	24.5	28.75	167	15	(2) 16x20x1

- ① Silicon Nitride Igniter.
- ② Isolated Combustion System. AFUE may vary based on poise.
- ③ ENERGY STAR®

## A952V - Two Stage, Variable Speed ECM



**A952V**  
Gas Furnace

**Table AMFUR-3-C — A952V Variable Speed, 2 Stage, 96% AFUE, Upflow Gas Furnace**

Model Number	Input (BTUH)		ICS AFUE <sup>②</sup>	Flue Size (in.)	Ignition Device	Uncrated Dimensions (in.)			Shipping Weight (lbs.)	Max. Fuse*	Filter Sizes
	1st Stage	2nd Stage				H	W	D			
A952V040BU3SAC	26,000	40,000	96.0 <sup>③</sup>	2, 3, 4	①	34	17.5	28.75	122	15	16x25x1
A952V060BU3SAC	39,000	60,000	96.0 <sup>③</sup>	2, 3, 4	①	34	17.5	28.75	127	15	16x25x1
A952V060BU4SAC	39,000	60,000	96.0 <sup>③</sup>	2, 3, 4	①	34	17.5	28.75	130	15	16x25x1
A952V080BU4SAC	52,000	80,000	96.0 <sup>③</sup>	2, 3, 4	①	34	17.5	28.75	135	15	16x25x1
A952V080CU5SAC	52,000	80,000	96.0 <sup>③</sup>	2, 3, 4	①	34	21	28.75	149	15	20x25x1
A952V100CU4SAC	65,000	100,000	96.0 <sup>③</sup>	2, 3, 4	①	34	21	28.75	154	15	20x25x1
A952V100CU5SAC	65,000	100,000	96.0 <sup>③</sup>	2, 3, 4	①	34	21	28.75	155	15	20x25x1
A952V120DU5SAC	78,000	120,000	96.0 <sup>③</sup>	3, 4	①	34	24.5	28.75	167	15	24x25x1

**Table AMFUR-3-D — A952V Variable Speed, 2 Stage, 96% AFUE, Downflow Gas Furnace**

Model Number	Input (BTUH)		ICS AFUE <sup>②</sup>	Flue Size (in.)	Ignition Device	Uncrated Dimensions (in.)			Shipping Weight (lbs.)	Max. Fuse*	Filter Sizes
	1st Stage	2nd Stage				H	W	D			
A952V040BD3SAC	26,000	40,000	96.0 <sup>③</sup>	2, 3, 4	①	34	17.5	28.75	122	15	14x20x1
A952V060BD3SAC	39,000	60,000	96.0 <sup>③</sup>	2, 3, 4	①	34	17.5	28.75	127	15	14x20x1
A952V080BD4SAC	52,000	80,000	96.0 <sup>③</sup>	2, 3, 4	①	34	17.5	28.75	135	15	14x20x1
A952V100CD4SAC	65,000	100,000	96.0 <sup>③</sup>	2, 3, 4	①	34	21	28.75	154	15	16x20x1
A952V100CD5SAC	65,000	100,000	96.0 <sup>③</sup>	2, 3, 4	①	34	21	28.75	155	15	16x20x1
A952V120DD5SAC	78,000	120,000	96.0 <sup>③</sup>	3, 4	①	34	24.5	28.75	167	15	16x20x1

- ① Silicon Nitride Igniter.
- ② Isolated Combustion System. AFUE may vary based on poise.
- ③ ENERGY STAR®

\* Information subject to change. Please confirm with current Product Data/Service Facts for current factory production.

# 95+% AFUE Furnaces

**Table AMFUR-4-A — Features**

	A951X Constant Torque	A952V Variable Speed
• AFUE .....	Up to 96%	96%
• Direct drive, variable speed ECM blower motor - Constant airflow ECM (electronically commutated motor) .....	—	✓
• Two stage combination gas valve and regulator .....	—	✓
• Constant Torque Electronically Commutated Motor (ECM) .....	✓	—
• Single-stage combination gas valve and regulator .....	✓	—
• 34" cabinet height .....	✓	—
• 3 Way poise Upflow furnace model (Upflow, Horizontal Left, Horizontal Right) .....	✓	✓
• 29–4C Stainless Steel Secondary Heat Exchanger .....	✓	✓
• Adjustable blower off delay for heating and cooling .....	✓	✓
• Alternate bottom/left/right return air (upflow models only) .....	✓	✓
• Bottom panel .....	✓	✓
• Cabinet has no knockouts - Rubber and plastic plugs come installed from factory .....	✓	✓
• Condensate can exit either side of cabinet in Upflow orientation .....	✓	✓
• Dedicated Downflow furnace model .....	✓	✓
• FER compliant .....	✓	✓
• Front service access with easily accessible burners, sensors, orifices, switches, and other components .....	✓	✓
• Gas can enter either side of cabinet .....	✓	✓
• Gasketed inner and outer door .....	✓	✓
• Heavy gauge reinforced wrap-around steel cabinet .....	✓	✓
• Alpha-numeric diagnostic codes .....	✓	✓
• Last six fault codes are stored (even with power loss) .....	✓	✓
• Left/right condensate drain capability in vertical application .....	✓	✓
• Longer IFC wire harnesses allow door to be removed without disconnecting the harness .....	✓	✓
• Manual reset flame roll out switches .....	✓	✓
• Meets requirements for 1.4% cabinet air leakage .....	✓	✓
• Mobile home approved with mobile home kit .....	✓	✓
• Multiple heating blower speeds .....	✓	✓
• Multiple venting options - Every model, every size will offer two venting options .....	✓	✓
• Multi-port in shot burners .....	✓	✓
• Integrated Furnace Control board with digital configuration, status, and fault codes .....	✓	✓
• Service diagnostic capabilities .....	✓	✓
• Service diagnostics with faults reported on IFC board .....	✓	✓
• Side return duct starter tabs (upflow models only) .....	✓	✓
• Silicon Nitride 120V hot surface igniter .....	✓	✓
• Slide out blower assembly on full-length rails .....	✓	✓
• Tubular Stainless Steel Primary Heat Exchanger .....	✓	✓
• <b>5-year functional parts limited warranty/Production Registration Not Required</b> .....	✓	✓
• <b>10-year functional parts warranty/product registration required*</b> .....	✓	✓
• <b>Commercial Applications: Limited Warranty Heat exchangers 20 years. All other functional parts 1 year</b> .....	✓	✓

\* Registered Limited Warranty terms are available when you register within 60 days of installation. You can register online at ameristarhvac.com or by phone at 855-260-2975, otherwise Ameristar's Base Limited Warranty terms will apply. Base Limited Warranty information on specific products can be found on ASDealerNet.com.

Ameristar®  
Furnaces



# 95+% AFUE Furnaces

**Table AMSC-5-A — Optional Accessories**

Model Number	Description	Shipping Weight	A951X Constant Torque	A952V Variable Speed
BAYLPSS400B	LP Kit with Stainless Steel Burners	3	✓	✓
BAYHANG	Horizontal hanging kit	2	✓	✓
BAYVENT200B	Sidewall vent Termination Kit fo Direct vent furnaces	2	✓	✓
BAYVENTCN200B	Sidewall vent Termination Kit fo Direct vent furnaces for Canadian applications	2	✓	✓
BAYAIR30AVENTA	Concentric vent kit for 2, 2½ and 3" vent system	11	✓	✓
BAYAIR30CNVENT	Concentric vent kit for 2, 2½ and 3" vent system for Canadian applications	11	✓	✓
BAYREDUCE	Reducer Coupling for Canadian applications (CPVC)	1	✓	✓
BAYLIFTB	Dual return kit. B size extension	8	✓	✓
BAYLIFTC	Dual return kit. C size extension	9	✓	✓
BAYLIFTD	Dual return kit. D size extension	9	✓	✓
BAYMFGH200B	Manufactured/mobile home kit	1	✓	✓
BAYCNDTRAP2A	In-line condensate collector for 2" PVC pipe	1	✓	✓
BAYCNDTRAP3A	In-line condensate collector for 3" PVC pipe	1	✓	✓
BAYBASE205	Downflow subbase	8	✓	✓
BAYFLTR206	Filter Access Door Kit (Downflow only)	2	✓	✓
MAYBFERCOLKITA <sup>①</sup>	Heat Shield, B size cabinet	3	✓	✓
MAYCFERCOLKITA <sup>①</sup>	Heat Shield, C size cabinet	3	✓	✓
MAYDFERCOLKITA <sup>①</sup>	Heat Shield, D size cabinet	3	✓	✓
BAYSF1165	16x20 1" side return filter rack		✓	✓
BAYSF1255	16x25 1" side return filter rack (bottom return for 17.5" cabinets)		✓	✓
BAYBURNERSS	Stainless steel natural gas burner kit		✓	✓

<sup>①</sup> Required on furnaces manufactured on or after 7/3/19 (with date code 19273 or after) when installed with a 4MXC or 4GXC coils in upflow or horizontal position. Not required in Downflow orientation.

# Packaged Cooling Convertible 2-5 Tons



**4TCA4**

**Table AMPK-1-A — 14 SEER - 4TCA4 Convertible Packaged Cooling - R-410A**

Model Number	Cooling Capacity (BTUH) ①	SEER/EER	Shipping Weight (lbs.)	MCA ②	Max. Fuse	Sound Rating	Uncrated Dimensions (in.)		
							H	W	D
4TCA4024A1000A	23,000	14.0/11.5	364	17	25	77	36.15	60.81	34.90
4TCA4030A1000A	29,000	14.0/11.5	364	20	30	77	36.15	60.81	34.90
4TCA4036A1000A	35,000	14.0/11.5	380	24	35	79	36.15	60.81	34.90
4TCA4042A1000A	41,000	14.0/11.5	430	31	50	79	36.15	60.81	34.90
4TCA4048A1000A	47,000	14.0/11.5	530	32	50	79	41.15	60.81	34.90
4TCA4060A1000A	57,000	14.0/11.5	551	40	60	78	41.15	60.81	34.90

① Rated in accordance with AHRI Standard 210/240.

② Calculated in accordance with currently prevailing Nat'l Electrical Code.

ONLINE ONLY COPY

# Packaged Cooling Convertible 2-5 Tons

**Table AMPK-2-A — Features**

	4TCA4
• SEER up to .....	14.00
• All-aluminum coil .....	2-4
• Copper Tube/Aluminum Fin outdoor coil (5-Ton only) .....	5
• Ease of installation with small footprint.....	✓
• Designed to accommodate manufactured homes.....	✓
• Fits low lot lines.....	✓
• <b>10-year compressor &amp; coil, 5-year all other functional parts limited warranty with registration* (Residential Use)</b> .....	✓
• <b>Extended warranties available</b> .....	✓

\* Registered Limited Warranty terms are available when you register within 60 days of installation. You can register online at ameristarhvac.com or by phone at 855-260-2975, otherwise Ameristar's Base Limited Warranty terms will apply. Base Limited Warranty information on specific products can be found on ASDealerNet.com.

**Table AMPK-2-B — Optional Accessories**

Model Number	Description	Used with Accessory	
BAYUTIL103A	Through the Base Utilities Curb Extension .....		2-5
BAYCCHT102A	Crankcase Heater .....		3.5-5
BAYCCHT103A	Crankcase Heater .....		3
BAYLOAM105A	Low Ambient Cooling Control Kit .....		2-5
BAYQSTK301AB	Quick Start Kit .....		3-5
BAYSQRD001A	Square to Round Adaptor Kit .....		2-3
BAYSQRD002A	Square to Round Adaptor Kit .....		3.5-5
BAYEXMK001A	Extreme Condition Mounting Kit .....	BAYCURB	2-5
BAYEXMK002B	Extreme Condition Mounting Kit .....	BAYUTIL	2-5
BAYEXMK003A	Extreme Condition Mounting Kit .....	Used on slab mounts.....	2-5
BAYSPEK071	Single Power Entry Kit .....	BAYHTR1V15, BAYHTR1V20	2.5-5
BAYSPEK072	Single Power Entry Kit .....	BAYHTR1V05, BAYHTR1V08, BAYHTR1V10.....	2-5

Model Number	Description	Matched with Accessory Heater	4TCA4
BAYSPEK071	Single Power Entry Kit	BAYHTR1V15	2.5-5
		BAYHTR1V20	4-5
BAYSPEK072	Single Power Entry Kit	BAYHTR1V05	2-5
		BAYHTR1V08	2-5
		BAYHTR1V10	2-5

**Electric Heaters**

Model Number	Description	4TCA4
BAYHTR1V05LUGAA	5 KW Heater	2-5
BAYHTR1V08LUGAA	8 KW Heater	2-5
BAYHTR1V10LUGAA	10 KW Heater	2-5
BAYHTR1V15BRKAA	15 KW Heater	2.5-5
BAYHTR1V20BRKAA	20 KW Heater	4-5

**Comfort Controls — See Comfort Controls/Zone Sensors Section**

For complete equipment / combination selections, installation instructions and warranty information, please refer to Product Data/Ratings and/or Installers Guides and Limited Warranty Handbooks.

# Packaged Heat Pump Convertible 2-5 Tons



**4WCA4**

**Table AMPK-3-A — 14 SEER - 4WCA4 Convertible Packaged Heat Pump - R-410A**

Model Number	Capacity (tons)	SEER	Cooling / Heating Capacity	HSPF	Shipping Weight (lbs.)	MCA ②	Max. Fuse	Sound Rating	Uncrated Dimensions (in.)		
									H	W	D
4WCA4024A1000A	2	14.0	23600 / 22000	8.0	390	22	35	76	36.15	60.81	34.90
4WCA4030A1000A	2.5	14.0	29000 / 27200	8.0	400	25	35	79	36.15	60.81	34.90
4WCA4036A1000A	3	14.0	35000 / 32600	8.0	405	30	45	79	36.15	60.81	34.90
4WCA4042A1000A	3.5	14.0	41000 / 37200	8.0	472	33	50	79	36.15	60.81	34.90
4WCA4048A1000A	4	14.0	47000 / 43500	8.0	517	35	50	79	41.15	60.81	34.90
4WCA4060A1000A	5	14.0	56500 / 53500	8.0	518	42	60	79	41.15	60.81	34.90

ONLINE ONLY COPY

# Packaged Heat Pump Convertible 2-5 Tons

**Table AMPK-4-A — Features**

	4WCA4
• SEER up to .....	14.00
• Copper Tube/Aluminum Fin outdoor coil .....	2-5
• Ease of installation with small footprint.....	✓
• Designed to accommodate manufactured homes.....	✓
• Fits low lot lines.....	✓
• <b>10-year compressor &amp; coil, 5-year all other functional parts limited warranty with registration* (Residential Use)</b> .....	✓
• <b>Extended warranties available</b> .....	✓

\* Registered Limited Warranty terms are available when you register within 60 days of installation. You can register online at ameristarhvac.com or by phone at 855-260-2975, otherwise Ameristar's Base Limited Warranty terms will apply. Base Limited Warranty information on specific products can be found on ASDealerNet.com.

**Table AMPK-4-B — Optional Accessories**

Model Number	Description	Used with Accessory	
BAYCURB060A	Flat Roof Full Perimeter Curb .....		2-5
BAYUTIL103A	Roof Curb Utility Extension Kit.....		2-5
BAYCCHT102A	Crankcase Heater .....		3.5-5
BAYCCHT103A	Crankcase Heater .....		2-3
BAYLOAM105A	Low Ambient Control Kit .....		2-5
TAYSTAT250C	Outdoor Thermostat Kit.....		2-5
BAYQSTK301A	Start Kit (Scroll).....		2-5
BAYSQRD001B	16" Round Duct Adapter .....		2-3
BBAYSQRD002B	18" Round Duct Adapter .....		3.5-5
BAYEXMK001A	Extreme Condition Mounting Kit .....	BAYCURB	2-5
BAYEXMK002B	Extreme Condition Mounting Kit .....	BAYUTIL	2-5
BAYEXMK003A	Extreme Condition Mounting Kit .....	Slab mounting	2-5

Model Number	Description	Matched with Accessory Heater	4WCA4
BAYSPEK070A	Single Power Entry Kit	BAYHTR1V05	3.5-5
		BAYHTR1H08	2-5
		BAYHTR1H10	2-5
BAYSPEK071A	Single Power Entry Kit	BAYHTR1H15	3-5
		BAYHTR1H20	5
BAYSPEK072A	Single Power Entry Kit	BAYHTR1V05	2-3

**Electric Heaters**

Model Number	Description	4WCA4
BAYHTR1V05LUGAA	Electric heater 5 KW	2-5
BAYHTR1H08LUGAA	Electric heater 7.5 KW	2-5
BAYHTR1H10LUGAA	Electric heater 10 KW	2-5
BAYHTR1H15BRKAA	Electric heater 15 KW	2.5-5
BAYHTR1H20BRKAA	Electric heater 20 KW	4-5

**Comfort Controls — See Comfort Controls/Zone Sensors Section**

For complete equipment / combination selections, installation instructions and warranty information, please refer to Product Data/Ratings and/or Installers Guides and Limited Warranty Handbooks.

# Packaged Gas/Electric Convertible 2-5 Tons



4YCA4

**Table AMPK-5-A — 14 SEER - 4YCA4 Convertible Packaged Gas/Electric - R-410A**

Model Number	Cooling Capacity (BTUH) ①	Heating Capacity Input/Output	SEER/EER	AFUE (%)	Shipping Weight (lbs.)	MCA ②	Max. Fuse	Sound Rating	Uncrated Dimensions (in.)		
									H	W	D
4YCA4024A1000A									36.15	60.81	34.90
4YCA4030A1000A									36.15	60.81	34.90
4YCA4036A1000A									36.15	60.81	34.90
4YCA4042A1000A									36.15	60.81	34.90
4YCA4048A1000A									41.15	60.81	34.90
4YCA4060A1000A									41.15	60.81	34.90

① Rated in accordance with AHRI Standard 210/240.  
② Calculated in accordance with currently prevailing Nat'l Electrical Code.

ONLINE ONLY COMING SOON

# Roof Curbs

## BAYCURB050A FULL PERIMETER ROOF MOUNTING CURB OUTLINE

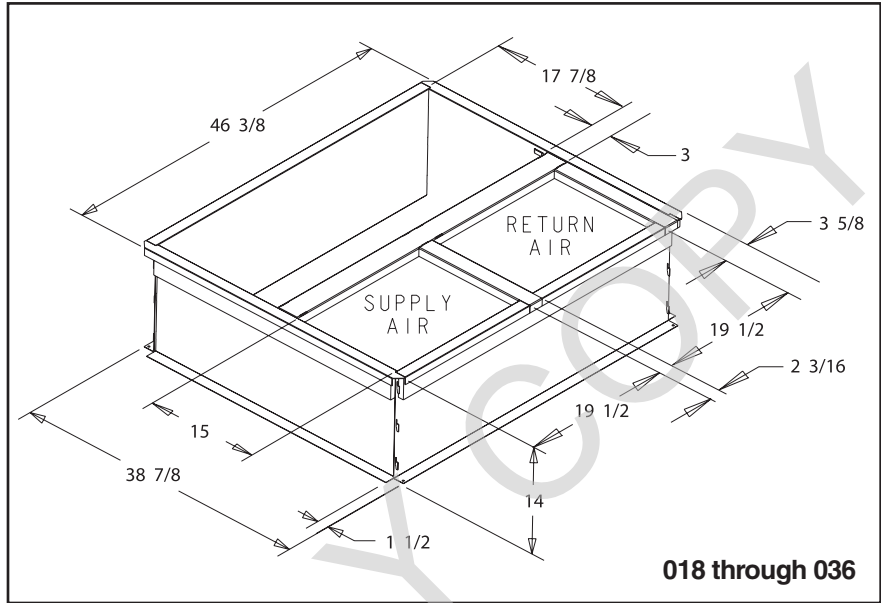

Full Perimeter BAYCURB050A	Full Perimeter BAYCURB051A
4TCY4024-036	4TCY4042-060
4TCX3018-036/4TCC3018-036	4TCX3042-060/4TCC3042-060
4WCZ6036/4DCZ6036	4WCZ6048-060/4DCZ6048-060
4WCY4024-036/4DCY4024-036	4WCY4042-060/4DCY4042-060
2/4WCX3018-036/2/4WCC3018-036	2/4WCX3042-060/2/4WCC3042-060
4YCZ6036	4YCZ6048-060
4YCY4024-036	4YCY4042-060
2/4YCX3018-036/2/4YCC3018-036	2/4YCX3042-060/2/4YCC3042-060

## BAYCURB051A FULL PERIMETER ROOF MOUNTING CURB OUTLINE

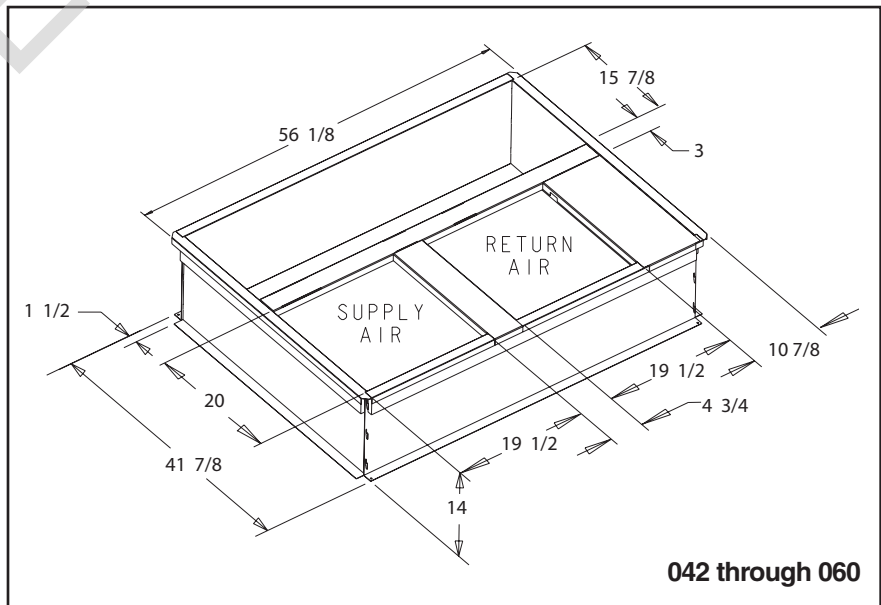

Accessories/Information

# Thermal Expansion Valves

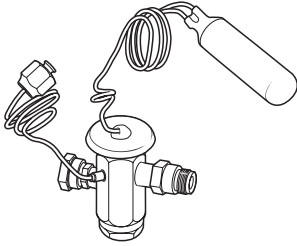

**Expansion Valve TXV  
Cooling/Heat Pump Kit**

**General Information**

This Thermostatic Expansion Valve Kit may be used on any indoor air handler or coil that is equipped with a current thermostatic expansion valve with an internal check valve and mechanical fittings. This kit can be used on split system heat pumps and air conditioning systems.

Thermostatic Expansion Valve Kits can be field installed to fit a variety of sizes and combinations of air handlers or coils and outdoor units to optimize performance.

This TXV kit will normally be used when a different refrigerant is going to be used in the air handler or coil than what is indicated on the unit name plate. The TXV type must always match the refrigerant type used in the outdoor unit.

**Kit Identification**

The first character in the kit model number indicates the type of refrigerant that the valve can be used with. Example a 2AYTXVH3D1830A is an R-22 valve.

The "3" in the eighth digit in the model number identifies the valve as a non-bleed TXV. When this TXV kit is installed with an outdoor unit that contains a reciprocating compressor, the outdoor unit must be equipped with a hard start kit if not factory installed. If the outdoor unit contains a scroll compressor, the installation of a hard start kit may be required.

**Inspection**

Check carefully for any shipping damage. Any such damage must be reported and claims made against the transportation company immediately. Any missing parts should be reported to your supplier at once and replaced with authorized parts only.

**Table AC/IN-2-A Cooling/Heat Pump Non-Bleed TXV Kits- Dual Direction Flow-TXA/C-BC Coils**

R-410 Model Number	R-22 Model Numbers	Used With 13 SEER Coils
4AYTXVH3D1831A	2AYTXVH3C1818A	2/4TXC, TXA018
4AYTXVH3D1831A	2AYTXVH3C2425A	2/4TXC, TXA024,025
4AYTXVH3D1831A	2AYTXVH3C3031A	2/4TXC, TXA031
4AYTXVH3D3343A	—4TXC, 4TXA-032	
4AYTXVH3D3343A	2AYTXVH3C3337A	2/4TXC, TXA036,037
4AYTXVH3D3343A	2AYTXVH3C4243A	2/4TXC, TXA042,043
4AYTXVH3D4863A	—4TXC, 4TXA-044	
4AYTXVH3D4863A	2AYTXVH3C4850A	2/4TXC, TXA048,049,050
4AYTXVH3D4863A	2AYTXVH3C5463A	2/4TXC, TXA060,061,064

**Table AC/IN-2-B Cooling/Heat Pump Non-Bleed TXV Kits- Dual Direction Flow**

R-410 Model Number	R-22 Model Number	Used With Horizontal Flat Coils
4AYTXVH3D1831A	2AYTXVH3C1818A	2/4TXF-018
4AYTXVH3D3343A	2AYTXVH3C3337A	2/4TXF-033
4AYTXVH3D3343A	2AYTXVH3C4243A	2/4TXF-041
4AYTXVH3D4863A	2AYTXVH3C5463A	2/4TXF-054
4AYTXVH3D4863A	2AYTXVH3C5463A	2/4TXF-063

**Table AC/IN-2-C Cooling/Heat Pump Non-Bleed TXV Kits- Dual Direction Flow-TXA/C-AS Coils**

R-410 Model Number	R-22 Model Number	Used With AS Aluminum Coils
4AYTXVH3B2531A	2AYTXVH3B2531A	2/4TXA, TXC-025
4AYTXVH3B2531A	2AYTXVH3B2531A	2/4TXA, TXC-031
4AYTXVH3B3654A	2AYTXVH3B3637A	2/4TXA, TXC-036
4AYTXVH3B3654A	2AYTXVH3B3637A	2/4TXA, TXC-037
4AYTXVH3B3654A	2AYTXVH3B5454A	2/4TXA, TXC-054
4AYTXVH3B6165A	2AYTXVH3B6565A	2/4TXA, TXC-065

**Table AC/IN-2-D Cooling/Heat Pump Non-Bleed TXV Kits – Dual Direction Flow 4NXA/4NXC**

R-22 Number	Used With 4NXA & 4NXC Coils
2AYTXVH3E1824AA	4NXA, NXC – 018 - 024
2AYTXVH3E2536AA	4NXA, NXC – 025 - 036
2AYTXVH3E6363AA	4NXC - 063

**Table AC/IN-2-E Cooling/Heat Pump Non-Bleed TXV Kits- Dual Direction Flow**

R-410 Number	R-22 Numbers	Used With Air Handlers
4AYTXVH3D1830A	2AYTXVH3D1830A	2TFB-018-030
4AYTXVH3D1831A	2AYTXVH3D1830A	2TFB-036
4AYTXVH3D1831A	2AYTXVH3D1830A	2/4TFE-025
4AYTXVH3D1831A	2AYTXVH3D1830A	2/4TEC-018-030
—	2AYTXVH3D3636A	2/4TEC-036
4AYTXVH3D3642A	—	2/4TEC-036-042
—	2AYTXVH3D4260A	2/4TEC-042-060
4AYTXVH3D4863A	—	2/4TEC-048-060
4AYTXVH3D1831A	2AYTXVH3D1830A	2/4TEH-018-030
—	2AYTXVH3D3636A	4TEH-036
4AYTXVH3D3642A	—	2TEH-036-042
—	2AYTXVH3D4260A	4TEH-042-060
4AYTXVH3D4863A	—	2TEH-048-060
4AYTXVH3D1800A	2AYTXVH3D1830A	2/4TGB-018
4AYTXVH3D1830A	2AYTXVH3D1830A	2/4TGB-025
4AYTXVH3D1831A	2AYTXVH3D1830A	2/4TGB-030
4AYTXVH3D3600A	2AYTXVH3D1830A	2/4TGB-036
4AYTXVH3D3343A	2AYTXVH3D4260A	2/4TGB-042
4AYTXVH3D4863A	2AYTXVH3D4260A	2/4TGB-048
4AYTXVH3D3642A	2AYTXVH3D4260A	2/4TEE-039
4AYTXVH3D4863A	2AYTXVH3D4260A	2/4TEE-048-064

For complete equipment / combination selections, installation instructions and warranty information, please refer to Product Data/Ratings and/or Installers Guides and Limited Warranty Handbooks.



# Thermal Expansion Valves

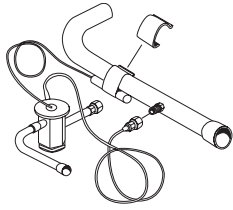

**Expansion Valve TXV Cooling Kit**

**Table AC/IN-3-A — Cooling Bleed TXV Kits – Single Direction Flow**

Model Number	Used With AC Units	Liquid Line Connection Dia. I.D. (In.)	Gas Line Connection Dia. I.D. (In.)	Shipping Weight (lbs.)	Refrigerant
TAYTXVA0B5C	1-1½ Ton	¼	⅝	2	R-22
TAYTXVA0C5C	2-2½ Ton	⅝ <sub>16</sub>	¾	2	R-22
TAYTXVA0E5C	3-3½ Ton	⅜	⅞	2	R-22
TAYTXVA0G5C	4 Ton	⅜	1⅛	2	R-22
TAYTXVA0H5C	5-6 Ton	⅜	1⅛	2	R-22

**Table AC/IN-3-B — Cooling Non-Bleed TXV Kits – Single Direction Flow**

Model Number	Used With AC Units	Liquid Line Connection Dia. I.D. (In.)	Gas Line Connection Dia. I.D. (In.)	Shipping Weight (lbs.)	Refrigerant
TAYTXVA0B3C	1-1½ Ton	¼	⅝	2	R-22
TAYTXVA0C3C	2-2½ Ton	⅝ <sub>16</sub>	¾	2	R-22
TAYTXVA0E3C	3-3½ Ton	⅜	⅞	2	R-22
TAYTXVA0G3C	4 Ton	⅜	1⅛	2	R-22
TAYTXVA0H3C	5-6 Ton	⅜	1⅛	2	R-22

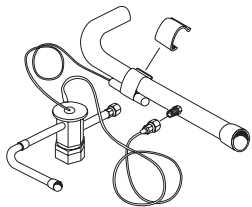

**Expansion Valve TXV Heat Pump Kit\***

**Table AC/IN-3-C — Heat Pump Non-Bleed TXV Kits (also for cooling) – Dual Direction Flow**

Model Number	Used With AC Units	Liquid Line Connection Dia. I.D. (In.)	Gas Line Connection Dia. I.D. (In.)	Shipping Weight (lbs.)	Refrigerant
TAYTXVH0B3C	1-1½ Ton	¼	⅝	3	R-22
TAYTXVH0C3C	2-2½ Ton	⅝ <sub>16</sub>	¾	3	R-22
TAYTXVH0E3C	3-3½ Ton	⅜	⅞	3	R-22
TAYTXVH0G3C	4 Ton	⅜	1⅛	3	R-22
TAYTXVH0H3C	5-6 Ton	⅜	1⅛	3	R-22

**Table AC/IN-3-D — Cooling/Heat Pump Non-Bleed TXV Kits - Dual Direction Flow\***

Model Number	Used With AC Units	Liquid Line Connection Dia. I.D. (In.)	Gas Line Connection Dia. I.D. (In.)	Shipping Weight (lbs.)	Refrigerant
TAYTXVH0D3C	2½ -3 Ton	⅜	1⅛	2	R-22
TAYTXVH0G3C	4-5 Ton	⅜	1⅛	2	R-22

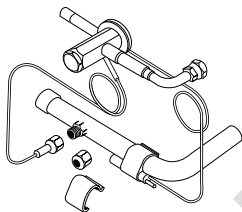

**Table AC/IN-3-E — R-410A Heat Pump Non-Bleed TXV Kits (also for cooling) - Dual direction flow**

Model Number	Used With HP/AC Units	Liquid Line Connection Dia. I.D. (In.)	Gas Line Connection Dia. I.D. (In.)	Shipping Weight (lbs.)	Refrigerant
4AYTXVH3A1830A	1½-2½ Ton	⅝ <sub>16</sub> ①	¾②	2	R-410A
4AYTXVH3A3654A	3-4 Ton	⅜	⅞③	2	R-410A
4AYTXVH3A6060A	5 Ton	⅜	⅞	2	R-410A

- ① 1 1/2 ton requires 1/4" liquid line; reducer fittings provided.
  - ② 1 1/2 ton requires 1/2" suction line, 2 ton requires 5/8; reducer fittings provided.
  - ③ 3 & 3 1/2 ton requires 3/4" suction line; reducer fitting provided.
- \* Used with TXH coils only where approved for use with 2 compressor systems.

**Notes:**

- Use in place of FCCV (Above) on air handlers and coils
- Match TXV kit size to outdoor nominal cooling capacity
- Braze field connections

# Equipment Date Identification

## 1980 – 2009

The nine (1980 thru 2004) digit serial numbers and all current ten (2004 to present) digit serial numbers on all American Standard central air conditioning and heating products are employed to identify the year and fiscal week of product manufacture.

Year of manufacture ..... First digit..... **M124X04CF**  
 Fiscal week of manufacture..... Second and third digit ..... **M124X04CF**  
 Day of week of manufacture..... Fourth digit ..... **M124X04CF**  
 Consecutive order of production ..... Last Five digits ..... **M124X04CF**

**Exception** – Accessories are an exception to the ten digit serial number assignment and may have only three digits to indicate date code. Coils which have only three digits to indicate date code are an exception to the nine digit serial number assignment.

Year	Residential, ID & OD <sup>①</sup> Light Commercial Products & Compressors	Ducane Oil <sup>①</sup> Horizontal Gas Furnaces <sup>②</sup>	Year	Residential, ID & OD <sup>①</sup> Light Commercial Products & Compressors	Ducane Oil <sup>①</sup> Horizontal Gas Furnaces <sup>②</sup>	Year	Residential, ID & OD <sup>①</sup> Light Commercial Products & Compressors	Ducane Oil <sup>①</sup> Horizontal Gas Furnaces <sup>②</sup>
1980	O, A	L	1997	M	97	2014	14	—
1981	T	M	1998	N	98	2015	15	—
1982	U	N	1999	P	99	2016	16	—
1983	W	9	2000	R	—	2017	17	—
1984	X	Q	2001	Z	—	2018	18	—
1985	Y	85	2002	2	—	2019	19	—
1986	S	86	2003	3	—	2020	20	—
1987	B	87	2004	4	—	2021	21	—
1988	C	88	2005	5	—	2022	22	—
1989	D	89	2006	6	—	2023	23	—
1990	E	90	2007	7	—	2024	24	—
1991	F	91	2008	8	—	2025	25	—
1992	G	92	2009	9 or 09	—			
1993	H	93	2010	10	—			
1994	J	94	2011	11	—			
1995	K	95	2012	12	—			
1996	L	96	2013	13	—			

① Beginning with 1/1/96 (L01) Ducane oil furnace production uses same date code method as gas furnace. Prior to 1/1/96 Ducane serial number used last four digits = date code, example HA1234569540 1995, 40th week.

Example: 123456-**8 5 4 0**

Year of manufacture \_\_\_\_\_ Fiscal week of manufacture \_\_\_\_\_

② Dedicated horizontal gas furnaces, production ceased after introduction of convertible furnaces. **2010**

Digit	Description	Current Digit Value Options
1 <sup>ST</sup>	Second to Last integer of the current calendar year	1 through 9 and blank space, Blank Space used when 0 (zero)
2 <sup>ND</sup>	Last integer of the current calendar year	0 through 9
3 <sup>RD</sup>	Fiscal Week (Tens numeral)	0 through 5
4 <sup>TH</sup>	Fiscal Week (Units numeral)	0 through 9
5 <sup>TH</sup>	Day of the Week	1 through 7
6 <sup>TH</sup>	Time Stamp	A through Z and 0 through 9, excluding I, O, Q, V, Y, and Z
7 <sup>TH</sup>	Time Stamp	A through Z and 0 through 9, excluding I, O, Q, V, Y, and Z
8 <sup>TH</sup>	Time Stamp	A through Z and 0 through 9, excluding I, O, Q, V, Y, and Z
9 <sup>TH</sup>	Assembly Line Designator	A through Z and 0 through 9, excluding I, O, Q, V, Y, and Z
10 <sup>TH</sup>	Plant Code	A, D, F, G, H, V, Y, X

Plant Codes: (starting around 1995)
A = Monterrey
D = Springhill, LA (used to be the last character of a 10 digit serial on Ft. Smith products when they were sold commercially back in the late 1980's)
F = Tyler, TX
G = Trenton, NJ
H = Ft. Smith, AR
L = Lynn Haven, FL
V = Vidalia, GA
X = Sourced products

# Refrigerant Line Sets

**Table AC/IN-5-A — Refrigerant Line Sets**

Model Number	Gas Line <sup>①②</sup> Dia. O.D.	Liquid Line Dia. O.D. Length	Shipping Weight
TAYREFLN325	7/8	3/8 25	20
TAYREFLN330	7/8	3/8 30	24
TAYREFLN340	7/8	3/8 40	30
TAYREFLN350	7/8	3/8 50	39
TAYREFLN725	3/4	3/8 25	19
TAYREFLN730	3/4	3/8 30	22
TAYREFLN740	3/4	3/8 40	28
TAYREFLN750	3/4	3/8 50	35
TAYREFLN950	5/8	3/8 50	30

① Gas line 90° bend one end.

② Gas line insulation 3/4" thickness.

**Note:** Contains a holding charge of Nitrogen.

**Table AC/IN-5-B — Refrigerant Line Sets**

Model Number	Res Old Accs Part Number	Gas Line Dia. O.D.	Liquid Line Dia.O.D.	Length	Insulation	Insulation Type	Bend	Plain Ends	Flare Fittings	Shipping Weight (per carton)
KIT17586		3/4"	3/8"	50	1/2"	Ez Pull	No	Yes	No	25
KIT16990	TAYREFLN750	3/4"	3/8"	50	1/2"	Standard	No	Yes	No	25
KIT17583		3/4"	3/8"	35	1/2"	Ez Pull	No	Yes	No	19
KIT17000	TAYREFLN730	3/4"	3/8"	30	1/2"	Standard	No	Yes	No	16
KIT16980		3/4"	3/8"	50	3/8"	Standard	No	Yes	No	24
KIT17001		3/4"	3/8"	35	3/8"	Standard	No	Yes	No	17
KIT17596		7/8"	3/8"	50	1/2"	Ez Pull	No	Yes	No	32
KIT16992	TAYREFLN350	7/8"	3/8"	50	1/2"	Standard	No	Yes	No	32
KIT17593		7/8"	3/8"	35	1/2"	Ez Pull	No	Yes	No	23
KIT17006	TAYREFLN330	7/8"	3/8"	30	1/2"	Standard	No	Yes	No	20
KIT16978		7/8"	3/8"	50	3/8"	Standard	No	Yes	No	31
KIT17002		7/8"	3/8"	35	3/8"	Standard	No	Yes	No	22
KIT17656	TAYREFLN965	5/8"	3/8"	50	1/2"	Mini Split Ez Pull	No	No	Yes	24
KIT17655	TAYREFLN960	5/8"	3/8"	25	1/2"	Mini Split Ez Pull	No	No	Yes	13
KIT17650	TAYREFLN060	3/8"	1/4"	50	1/2"	Mini Split Ez Pull	No	No	Yes	15
KIT17649	TAYREFLN050	3/8"	1/4"	25	1/2"	Mini Split Ez Pull	No	No	Yes	9
KIT17652	TAYREFLN570	1/2"	1/4"	50	1/2"	Mini Split Ez Pull	No	No	Yes	18
KIT17651	TAYREFLN560	1/2"	1/4"	25	1/2"	Mini Split Ez Pull	No	No	Yes	10
KIT17806	TAYREFLN165	5/8"	1/4"	50	1/2"	Mini Split Ez Pull	No	No	Yes	22
KIT17805	TAYREFLN155	5/8"	1/4"	25	1/2"	Mini Split Ez Pull	No	No	Yes	12
KIT17715		3/8"	NO	164	1/2"	Ez Pull	No	Yes	No	25
KIT17906		1/4"	NO	164	1/2"	Ez Pull	No	Yes	No	19
KIT17907		1/2"	NO	164	1/2"	Ez Pull	No	Yes	No	35
KIT17723		5/8"	NO	164	1/2"	Ez Pull	No	Yes	No	46

# Refrigerant HFC 410A (R-410A)

Tables contain no allowances for vertical lift!

**Table AC/IN-6-A — Liquid Line Selection Table for R-410A Single Speed Systems**

Maximum Allowable Liquid Line Pressure Drop ..... =

Subtract .43 PSI for each foot of Liquid Lift (if any).....

Do Not Exceed this value when selecting Liquid Line.....

Tube O.D.	Rated BTUH	Pressure Drop (PSI) For Total Equivalent Length											
		20'	40'	60'	80'	100'	120'	140'	160'	180'	200'	220'	240'
1/4"	15000	4.5	9.0	13.6	18.1	22.6	27.1	31.6	36.2	40.7	45.2	49.7	—
	18000	6.3	12.6	18.8	25.1	31.4	37.7	44.0	—	—	—	—	—
	24000	15.4	30.8	46.2	—	—	—	—	—	—	—	—	—
5/16"	15000	1.2	2.4	3.5	4.7	5.9	7.1	8.3	9.4	10.6	11.8	13.0	14.2
	18000	1.6	3.3	4.9	6.6	8.2	9.8	11.5	13.1	14.8	16.4	18.0	19.7
	24000	2.8	5.5	8.3	11.0	13.8	16.6	19.3	22.1	24.8	27.6	30.4	33.1
	30000	4.1	8.3	12.4	16.6	20.7	24.8	29.0	33.1	37.3	41.4	45.5	49.7
	36000	5.8	11.6	17.3	23.1	28.9	34.7	40.5	46.2	—	—	—	—
	42000	7.7	15.4	23.0	30.7	38.4	46.1	—	—	—	—	—	—
3/8"	24000	1.0	1.9	2.9	3.8	4.8	5.8	6.7	7.7	8.6	9.6	10.6	11.5
	30000	1.4	2.9	4.3	5.8	7.2	8.6	10.1	11.5	13.0	14.4	15.8	17.3
	36000	2.0	4.0	6.1	8.1	10.1	12.1	14.1	16.2	18.2	20.2	22.2	24.2
	42000	2.7	5.3	8.0	10.6	13.3	16.0	18.6	21.3	23.9	26.6	29.3	31.9
	48000	3.4	6.8	10.2	13.6	17.0	20.4	23.8	27.2	30.6	34.0	37.4	40.8
	60000	5.1	10.3	15.4	20.6	25.7	30.8	36.0	41.1	46.3	—	—	—
1/2"	60000	1.0	2.1	3.1	4.2	5.2	6.2	7.3	8.3	9.4	10.4	11.4	12.5

Note 1: A blank space indicates a pressure drop of over 50 PSI.  
 Note 2: Other existing sources of pressure drop, (solenoid valves, etc.) must be considered.  
 Note 3: A vertical run with a heat pump system always results in a liquid lift (heating or cooling).  
 Note 4: The smallest liquid line diameter that results in a total liquid line pressure drop of 50 PSI or less results in the most reliable system (fewer pounds of R-410A).  
 Note 5: It is recommended to place units where 1/2" liquid line is not required due to the increased refrigerant volume imposed by the larger liquid line.  
 Note 6: At the time this manual was printed all outdoor units were rated with 3/8" liquid line.

**Table AC/IN-6-B — Allowable Vapor Line Diameters and BTUH Loss (R-410A Single Speed Systems)**

Nominal Tons	Tube O.D. (Inches)	Press. Drop PSI/100 Ft.	BTUH Loss For Equivalent Length											
			40'	60'	80'	100'	120'	140'	160'	180'	200'	220'	240'	
1.0	1/2	5.0	70	160	250	340	430	520	610	700	790	880	970	
	5/8	1.5	20	50	73	100	130	155	180	210	235	265	290	
1.5	1/2	10.8	173	410	640	875	1110	1340	1575	1810	2040	2275	2510	
	5/8	3.1	50	120	185	250	320	385	450	520	585	655	720	
	3/4	1.2	20	45	70	95	125	150	175	200	225	255	280	
2.0	5/8	5.4	115	270	430	585	740	895	1050	1205	1360	1515	1670	
	3/4	2.0	45	100	160	215	275	330	390	445	505	560	620	
2.5	5/8	8.2	220	515	810	1110	1400	1695	1990	2290	2585	2880	3175	
	3/4	3.0	80	190	295	405	515	620	730	840	945	1055	1160	
	7/8	1.3	35	80	130	175	220	270	315	365	410	455	505	
3.0	5/8	11.7	380	885	1390	1895	2400	2905	3410	3915	4425	4930	—	
	3/4	4.3	140	325	510	700	880	1070	1255	1440	1625	1810	2000	
	7/8	1.9	60	145	225	310	390	470	555	635	720	800	880	
3.5	3/4	5.8	220	510	805	1095	1390	1680	1975	2265	2560	2850	3140	
	7/8	2.5	95	220	345	475	600	725	850	975	1105	1230	1355	
4.0	3/4	7.4	320	745	1170	1600	2025	2450	2875	3305	3730	4155	4580	
	7/8	3.2	140	325	510	690	875	1060	1245	1430	1615	1795	1980	
	1-1/8 <sup>③</sup>	.9	40	90	145	195	245	300	350	400	455	505	555	
5.0	3/4	11.5	620	1450	2280	3105	3935	4760	5590	6415	7245	8073	8900	
	7/8	4.9	265	615	970	1325	1675	2030	2380	2735	3080	3440	3795	
	1-1/8	1.3	70	165	255	350	445	540	630	725	820	915	1005	

Note 1: Shaded value indicates more than 10% capacity loss.  
 Note 2: Blank space indicates more than 15% capacity loss.  
 Note 3: Only approved for cooling units, do not use 1 1/8" vapor lines on heat pumps less than 5 ton.  
 Note 4: If linear length exceeds 150 feet, add 2 ounces of approved compressor oil per every 10 feet in excess of 150 feet. (Example: if the actual line length is 170 feet, add 4 ounces of oil to the system)

**This page contains limited data to fully determine if the application will work or to select required accessories. Please refer to publication SS-APG006E-EN for complete details and examples.**

For complete equipment / combination selections, installation instructions and warranty information, please refer to Product Data/Ratings and/or Installers Guides and Limited Warranty Handbooks.

# Refrigerant Piping Information for Two Stage Split Systems

**Table AC/IN-7-A — Allowable Vapor and Liquid Line Diameters for Two Stage, Single Compressor Split Systems**

Rated Line Sizes	Line Sizes		Service Valve Connection Size		Max Line & Lift Lengths	
	Vapor Line	Liquid Line	Vapor Line Connection	Liquid Line Connection	TOTAL Max Line Length (ft)	Max Lift (ft)
2 Ton HP	5/8"	3/8"	5/8"	3/8"	150'	50'
3 Ton HP	3/4"	3/8"	3/4"	3/8"	80'	25'
4 Ton HP	7/8"	3/8"	7/8"	3/8"	150'	50'
5 Ton HP	1-1/8"	3/8"	1-1/8"	3/8"	80'	25'

Alternate Line Sizes	Line Sizes		Service Valve Connection Size		Max Line & Lift Lengths	
	Vapor Line	Liquid Line	Vapor Line Connection	Liquid Line Connection	TOTAL Max Line Length (ft)	Max Lift (ft)
2 Ton HP	5/8"	3/8"	5/8"	3/8"	150'	50'
	3/4"	3/8"			80'	25'
3 Ton HP	5/8"	3/8"	3/4"	3/8"	150'	50'
	7/8"	3/8"			80'	25'
4 Ton HP	3/4"	3/8"	7/8"	3/8"	150'	50'
5 Ton HP	3/4"	3/8"	1-1/8"	3/8"	150'	50'
	7/8"	3/8"			150'	50'

Rated Line Sizes	Line Sizes		Service Valve Connection Size		Max Line & Lift Lengths	
	Vapor Line	Liquid Line	Vapor Line Connection	Liquid Line Connection	TOTAL Max Line Length (ft)	Max Lift (ft)
2 Ton AC	5/8", 3/4"	3/8"	5/8"	3/8"	150'	50'
3 Ton AC	5/8", 3/4", 7/8"	3/8"	3/4"	3/8"	150'	50'
4 Ton AC	3/4", 7/8"	3/8"	7/8"	3/8"	150'	50'
5 Ton AC	3/4", 7/8", 1-1/8"	3/8"	1-1/8"	3/8"	150'	50'

See Application Bulletin SS-APB011-EN

**Table AC/IN-7-B — Equivalent Length (Ft.) of Non-Ferrous Valves and Fittings (Brazed)**

O.D. Tube Size (Inches)	Globe Valve	Angle Valve	Short Radius Ell	Long Radius Ell	Tee Line Flow	Tee Branch Flow
1/2"	70	24	4.7	3.2	1.7	6.6
5/8"	72	25	5.7	3.9	2.3	8.2
3/4"	75	25	6.5	4.5	2.9	9.7
7/8"	78	28	7.8	5.3	3.7	12.0
1-1/8"	87	29	2.7	1.9	2.5	8.0
1-3/8"	102	33	3.2	2.2	2.7	10.0
1-5/8"	115	34	3.8	2.6	3.0	12.0

Information for this chart extracted by permission from A.R.I. Refrigerant Piping Data, page 28.

\* For smaller sizes, use 1/2" values.

**This page contains limited data to fully determine if the application will work or to select required accessories. Please refer to publication SS-APG006E-EN for complete details and examples.**

For complete equipment / combination selections, installation instructions and warranty information, please refer to Product Data/Ratings and/or Installers Guides and Limited Warranty Handbooks.

# Split Systems with Side Discharge Variable Speed Compressor

Table AC/IN-8-A — Charge Chart VSPD Side Discharge

R-410A REFRIGERANT CHARGING CHART							
LIQUID TEMP (°F)	DESIGN SUBCOOLING (°F)						
	8	9	10	11	12	13	14
	LIQUID GAGE PRESSURE (PSI)						
55	179	182	185	188	191	195	198
60	195	198	201	204	208	211	215
65	211	215	218	222	225	229	232
70	229	232	236	240	243	247	251
75	247	251	255	259	263	267	271
80	267	271	275	279	283	287	291
85	287	291	296	300	304	309	313
90	309	313	318	322	327	331	336
95	331	336	341	346	351	355	360
100	355	360	365	370	376	381	386
105	381	386	391	396	402	407	413
110	407	413	418	424	429	435	441
115	435	441	446	452	458	464	470
120	464	470	476	482	488	495	501
125	495	501	507	514	520	527	533
Refer to Service Facts or Installer's Guide for charging method.							

From Dwg. D154557P01 Rev. 3

Table AC/IN-8-C — Alternate Line Sizes VSPD Side Discharge

MODEL	LINE SIZE		SERVICE VALVE SIZE	
	Vapor Line	Liquid Line	Vapor Line	Liquid Line
HP 4A6L9				
HP 024	5/8"	3/8"	5/8"	3/8"
HP 036	5/8", 3/4" (a)	3/8"	3/4"	3/8"
HP 048	3/4", 7/8" (a)	3/8"	7/8"	3/8"
HP 060	3/4", 7/8" (a)(b)	3/8"	7/8"	3/8"

(a) The maximum length of refrigerant lines from outdoor to indoor unit must NOT exceed 150 feet. The maximum vertical change must NOT exceed 50 feet.

(b) Refer to Subcool Charts for length and lift ability.

**Notes:**

The weigh in method provides an approximation of refrigerant charge; proper charge will vary with indoor coil selections.

In ambient conditions below 55°F, reference the heating refrigerant pressure curves for typical performance.

Return in the cooling season when the ambient temperature is above 55°F to balance the refrigerant charge by subcooling.

Table AC/IN-8-B — Line Sizes VSPD Side Discharge Rated Line Sizes

MODEL	RATED LINE SIZE		SERVICE VALVE CONNECTION SIZE	
	Vapor Line	Liquid Line	Vapor Line	Liquid Line
HP 4A6L9				
HP 024	5/8" (a)	3/8"	5/8"	3/8"
HP 036	3/4" (a)	3/8"	3/4"	3/8"
HP 049	7/8" (a)	3/8"	7/8"	3/8"
HP 060	7/8"(a)(b)	3/8"	7/8"	3/8"

(a) The maximum length of refrigerant lines from outdoor to indoor unit must NOT exceed 150 feet. The maximum vertical change must NOT exceed 50 feet.

(b) Refer to Subcool Charts for length and lift ability.

# Branch Circuit Wire Sizing Table/ Heater De-Rating Chart

## BRANCH CIRCUIT WIRE SIZING TABLE

(Based on 2% Voltage Drop)

Chart is based on 75° C. wire. (Types FEPW, RH, RHW, THW, THWN, XHHW, USE, AND ZW.)  
 Use Chart For Wire Sizing Only. Refer To Electrical Code, (Or Product Specs.) For Fuse Sizing

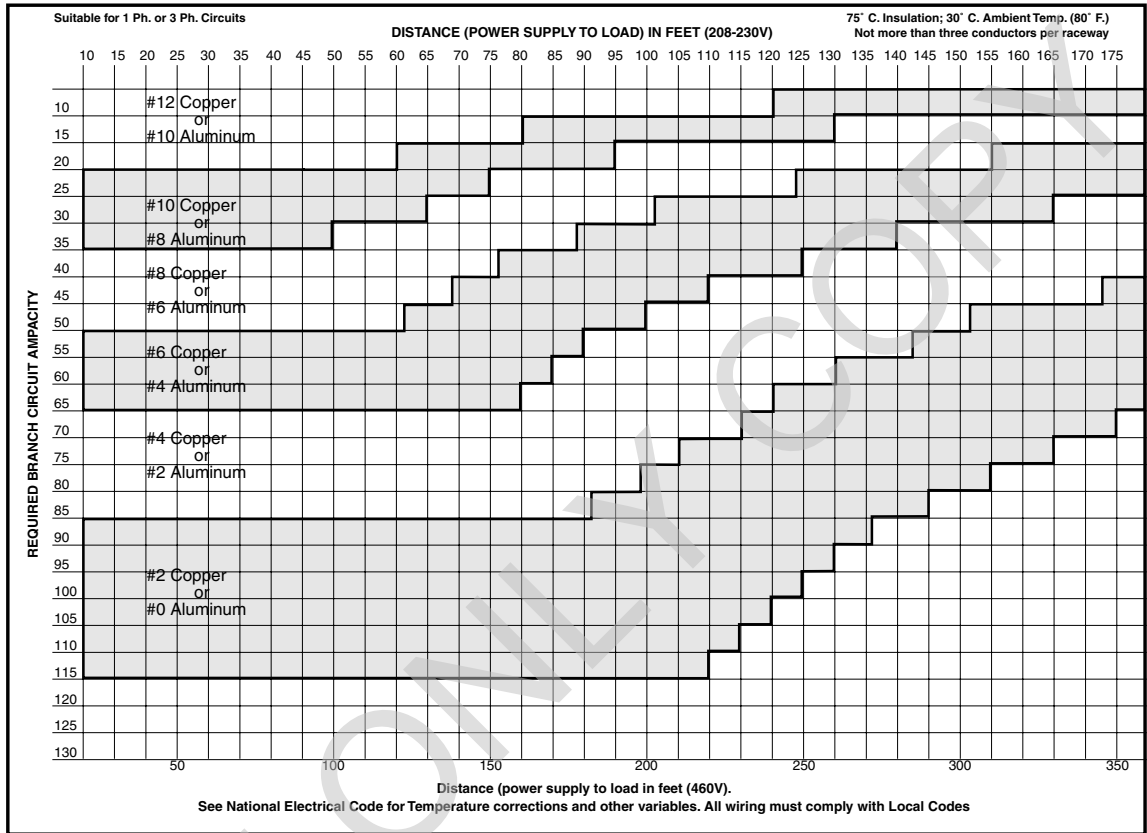

## Heater De-Rating Chart

The output of electric heaters, applied at voltages other than the rated 240 or 480 volts, can be easily determined with the use of this chart.

### ELECTRIC HEATER DE-RATING CHART

(for 240V or 480V Rated Heaters Installed on Lower Voltage Systems)

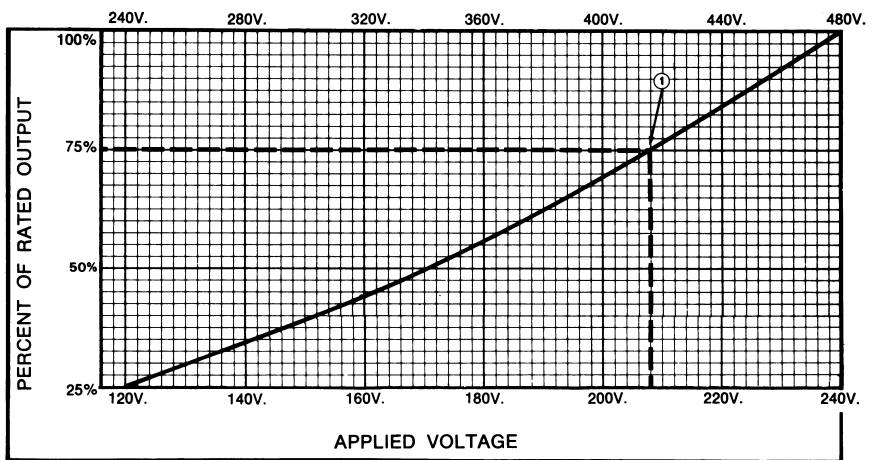

① EXAMPLE: Calculated Heat Loss — 29,200 BTUH Power Supply — 208V.  
 The chart indicates that any 240V heater will deliver 75% of its rated capacity at 208V.

$$\frac{29,200 \text{ BTUH}}{.75} = 39,000 \text{ BTUH} \quad \left\{ \begin{array}{l} \text{Select a heater having AT LEAST 39,000 BTUH} \\ \text{capacity at 240V.} \end{array} \right.$$

For complete equipment / combination selections, installation instructions and warranty information, please refer to Product Data/Ratings and/or Installers Guides and Limited Warranty Handbooks.

# Basic Air Conditioning Formulas

## Basic Air Conditioning Formulas

TO DETERMINE	EXPRESSED AS	COOLING	HEATING and/or HUMIDIFYING
Total Airflow	CFM <sub>T</sub>	1. $CFM_T = \frac{N_T V}{60 \text{ min./hr.}}$	1. $CFM_T = \frac{N_T V}{60 \text{ min./hr.}}$
Infiltration or Ventilation	CFM <sub>O</sub>	2. $CFM_O = \frac{N_O V}{60 \text{ min./hr.}}$	2. $CFM_O = \frac{N_O V}{60 \text{ min./hr.}}$
Number of Air Changes Per Hour – Total	N <sub>T</sub>	3. $N_T = \frac{CFM_T (60 \text{ min./hr.})}{V}$	3. $N_T = \frac{CFM_T (60 \text{ min./hr.})}{V}$
Number of Air Changes Per Hour – Outdoor Air	N <sub>O</sub>	4. $N_O = \frac{CFM_O (60 \text{ min./hr.})}{V}$	4. $N_O = \frac{CFM_O (60 \text{ min./hr.})}{V}$
Total Heat (H <sub>T</sub> )	Btuh	5. $H_T = CFM_T \times 4.5 \times (h_1 - h_2) = \text{Btuh}$	6. $H_T = CFM_T \times 4.5 \times (h_2 - h_1) = \text{Btuh}$
Sensible Heat (H <sub>S</sub> )	Btuh	7. $H_S = CFM_T \times 1.08 \times (T_1 - T_2) = \text{Btuh}$	8. $H_S = CFM_T \times 1.08 \times (T_2 - T_1) = \text{Btuh}$
Latent Heat (H <sub>L</sub> )	Btuh	9. $H_L = CFM_T \times .68 \times (W_1 - W_2) = \text{Btuh}$	10. $H_L = CFM_T \times .68 \times (W_2 - W_1) = \text{Btuh}$
Entering Air Temperature (T <sub>1</sub> ) (Mixed Air)	°F. D.B.	11. $T_1 = t_1 + \frac{CFM_O}{CFM_T} \times (t_2 - t_1) = \text{°F.D.B.} \text{ ①}$ ① If duct heat gain is a factor, add to T <sub>1</sub> : $\frac{\text{Duct Heat Gain (Btuh)}}{CFM_T \times 1.08}$	12. $T_1 = t_1 - \frac{CFM_O}{CFM_T} \times (t_1 - t_2) = \text{°F.D.B.} \text{ ②}$ ② If duct heat loss is a factor, subtract from T <sub>1</sub> : $\frac{\text{Duct Heat Loss (Btuh)}}{CFM_T \times 1.08}$
Leaving Air D.B. Temperature (T <sub>2</sub> )	°F. D.B.	13. $T_2 = T_1 - \frac{H_S}{CFM_T \times 1.08} = \text{°F.D.B.}$	14. $T_2 = T_1 + \frac{H_S}{CFM_T \times 1.08} = \text{°F.D.B.}$
Required Airflow	CFM <sub>T</sub>	15. $CFM_T = \frac{H_S (\text{total})}{1.08 \times (T_1 - T_2)} = \text{CFM}$ OR $CFM_T = \frac{H_S (\text{internal}) \text{ ③}}{1.08 \times (t_1 - T_2)} = \text{CFM}$ ③ Sensible load of outside air not included	16. $CFM_T = \frac{H_S}{1.08 \times (T_2 - T_1)} = \text{CFM}$
Enthalpy – Leaving Air (h <sub>2</sub> )	Btu/lb. dry air	17. $h_2 = h_1 - \frac{H_T}{CFM_T \times 4.5} = \text{Btu/lb. dry air}$	18. $h_2 = h_1 + \frac{H_T}{CFM_T \times 4.5} = \text{Btu/lb. dry air}$
Leaving Air W.B. Temperature	°F.W.B.	19. Refer to Enthalpy Table and read W.B. temperature corresponding to enthalpy of leaving air (h <sub>2</sub> ) (see #17).	20. Refer to Enthalpy Table and read W.B. temperature corresponding to enthalpy of leaving air (h <sub>2</sub> ) (see #18).
Heat Required to Evaporate Water Vapor Added to Ventilation Air	Btuh	21. $H_L = CFM_O \times .68 (W_3 - W_O) = \text{Btuh}$	22. $H_L = CFM_O \times .68 (W_3 - W_O) = \text{Btuh}$
Humidification Requirements	Lbs. water/hr.	23. $\left( \text{Make up Moisture} \right) = \frac{\text{Excess Latent Capacity of System} \times \% \text{ Run Time}}{1060 \text{ Btu/lb.}} = \text{lbs./hr.}$ (Industrial Process Work)	24. $\left( \text{Make up Moisture} \right) = \frac{H_L \text{ loss Btuh (see #22)}}{1060 \text{ Btu/lb.}} = \text{lbs./hr.}$

LEGEND	DERIVATION OF AIR CONSTANTS
<p>CFM<sub>T</sub> = Total airflow cubic feet/min.                      CFM<sub>O</sub> = Outdoor air cubic feet/min.                      N<sub>T</sub> = Total air changes per hour                      N<sub>O</sub> = Outdoor air, air changes per hour                      V = Volume of space cubic feet                      H<sub>T</sub> = Total heat Btuh                      H<sub>S</sub> = Sensible heat Btuh                      H<sub>L</sub> = Latent heat Btuh                      * h<sub>1</sub> = Enthalpy or total heat of entering air                      * h<sub>2</sub> = Enthalpy or total heat of leaving air                      T<sub>1</sub> = Temperature of entering air                      T<sub>2</sub> = Temperature of leaving air                      T<sub>adp</sub> = Apparatus dewpoint                      t<sub>1</sub> = Indoor design temperature                      t<sub>2</sub> = Outdoor design temperature                      W<sub>1</sub> = Grains of water/lb. of dry air at entering condition                      W<sub>2</sub> = Grains of water/lb. of dry air at leaving condition                      W<sub>3</sub> = Grains of water/lb. of dry air at indoor design conditions                      W<sub>O</sub> = Grains of water/lb. of dry air at outdoor design conditions</p>	<p>The air constants below apply specifically to standard air which is defined as dry air at 70°F and 14.7 P.S.I.A. (29.92 in. mercury column). They can, however, be used in most cooling calculations unless extremely precise results are desired.</p> <p>4.5 (To convert CFM to lbs./hr.)</p> <p><math>4.5 = \frac{60 \text{ min./hr.}}{13.33}</math> or <math>60 \times .075</math></p> <p>Where 13.33 is the specific volume of standard air (cu.ft./lb.) and .075 is the density (lbs./cu.ft.)</p> <p><math>1.08 = \frac{.24 \times 60}{13.33}</math> or <math>.24 \times 4.5</math></p> <p>.24 BTU = specific heat of standard air (BTU/LB./°F)</p> <p><math>.68 = \frac{.60}{13.33} \times \frac{1060}{7000}</math> or <math>4.5 \times \frac{1060}{7000}</math></p> <p>Where: 1060 = Average Latent Heat of water vapor (BTU/LB.).                      7000 = Grains per lb.</p>

\* See Enthalpy of air (Total Heat Content of Air) Table for exact values.



# Low Ambient Cooling Operation Accessories – Split Systems

**Table AC/IN-11-A - Low Ambient Accessories**

Air Conditioner Heat Pump	55° F. As Manufactured	55°F - 30°F				30F - 20F or 30F - 0F see lowest approved OD ambient					
		Air Conditioner AY28X079 <sup>②</sup>	Heat Pump AY28X084 <sup>②</sup>	TXV-NB	CCHT	BAYLOAM107*	Start Kit <sup>⑤</sup>	Solenoid Valve (AC) <sup>④</sup>	Windshield	Lowest Approved Outdoor Ambient Cooling Mode	
13 SEER	X	X	X	X	X	BAYLOAM107	X	X	X	Approved to 0° F	
14 SEER	X	X	X	X	X	BAYLOAM107	X	X	X	AC Approved to 20° F HP Approved to 10° F	
15 SEER	X	X	X	X	X	BAYLOAM107	X	X	X	AC Approved to 20° F HP Approved to 10° F	
16 SEER <sup>①</sup>	X	X	X	X	X	BAYLOAM107 <sup>①</sup>	X	X	X	AC Approved to 20° F HP Approved to 10° F	
17 SEER <sup>①</sup>	X	X	X	X	X	BAYLOAM107	X	X	X	AC Approved to 20° F HP Approved to 10° F	
18 SEER <sup>①</sup>	X	X	X	X	X	BAYLOAM107 <sup>①</sup>	X	X	X	AC Approved to 20° F HP Approved to 10° F	
18 SEER VS	X	Not Approved				Not Approved				Approved to 55° F	
20 SEER VS	X	Not Approved				Not Approved				Approved to 55° F	

- ① DO NOT apply BAYLOAM to model tonnages with variable speed condenser fan motors. Models with VS condenser fan motors are approved to 30°F
- ② AY28X\*\*\* EDC not required when indoor unit has EEV
- ③ VS 20 SEER OD units approved to 55°F
- ④ Liquid line solenoid shall be used for isolation purposes. Also used if liquid line is 1/2" and installed before the evaporator coil.  
See SS-APG006E-EN Refrigeration Piping Application Guide
- ⑤ Start Kit NOT required on 230v/460v/3 phase product

Please refer to publication SS-APG012B-EN for complete details and examples.

For complete equipment / combination selections, installation instructions and warranty information, please refer to Product Data/Ratings and/or Installers Guides and Limited Warranty Handbooks.

# Light Commercial Precedent Packaged Systems

---

Features and Benefits ..... LPRE-2

Application Considerations ..... LPRE-17

## **3-10 Ton Packaged Cooling**

Selection Procedure ..... LPRE-19

Model Number Description ..... LPRE-23

General Data (T/YSC) ..... LPRE-27

## **3-5 Ton Packaged Cooling**

Selection Procedure ..... LPRE-37

Model Number Description ..... LPRE-41

General Data (T/YHC) ..... LPRE-43

## **3-10 Ton Packaged Heat Pumps**

Selection Procedure ..... LPRE-45

Model Number Description ..... LPRE-47

General Data (WSC) ..... LPRE-49

General Data (WHC) ..... LPRE-52

General Data (DHC) ..... LPRE-55

# Precedent Packaged Systems Features and Benefits

**Table 1. Precedent™ features – standard and optional**

	Standard Features	Options <sup>(a)</sup>		
		Factory Installed	Factory or Field Installed	Field Installed
1-year Limited Parts Warranty	X			
5-year Limited Compressor Warranty	X			
5-year Limited Heat Exchanger Compressor Warranty	X			
10-year Warranty Stainless Steel Heat Exchanger		X		
2" MERV 8 Filters or 2" MERV 13 Filters with Filter Removal Tool		X		
Anti-Short Cycle Timer (Standard with ReliaTel™)	X			
Belt Drive Motors <sup>(b)</sup>	X			
Black Epoxy Pre-Coated Coils <sup>(c)</sup>		X		
Barometric Relief			X	
CO <sub>2</sub> Sensor (wiring only)		X		
CO <sub>2</sub> Sensor <sup>(d)</sup>				X
Clogged Filter/Fan Failure Switch			X	
CompleteCoat™ Condenser Coil		X		
Condensate Overflow Switch		X		
Condenser Coil	X			
Convertible Airflow	X			
Colored and Numbered Wiring	X			
Cooling (Standard or High Efficiency)	X			
Crankcase Heaters	X			
Demand Control Ventilation			X	
Dehumidification Option		X		
Direct Drive Plenum Fan <sup>(e)</sup>	X	X		
Discharge Air Temperature Sensing Kit			X	
Easy Access Low Voltage Terminal Board (LTB)	X			
Economizer: Standard			X	
Economizer: Low Leak				X
Electric Heaters			X	
Fault Detection & Diagnostics (FDD); Meets CA Title 24 Requirements		X		
Filters	X			
Foil-Faced and Edge Captured Insulation	X			
Frostat™			X	
Hail Guards			X	
Heat Exchanger	X			
High Pressure Control	X			
Hinged Access Doors		X		
High Altitude Kit				X
High Static Drive				X
IAQ Dual Sloped, Plastic, Removable and Removable Drain Pan	X			
Liquid Line Refrigerant Drier	X			
Low Ambient Cooling to 0°F on Microprocessor Models	X			
Low Ambient Cooling to 40°F on Electromechanical Models	X			
Low Pressure Control	X			
Low Voltage Connections	X			
LP Conversion Kit				X

# Precedent Packaged Systems Features and Benefits

**Table 1. Precedent™ features – standard and optional (continued)**

	Standard Features	Options <sup>(a)</sup>		
		Factory Installed	Factory or Field Installed	Field Installed
Manual Outside Air Damper				X
Microchannel Coils <sup>(f)</sup>	X			
Motorized Outside Air Damper				X
Multispeed Direct Drive Motors	X			
Multispeed Indoor Fan System		X		
Multiple Zone VAV (Variable Air Volume)		X		
Operating Charge of R-410A	X			
Outside Air Measuring/Monitoring Control (TraQ Dampers)				X
Phase Balance/Loss/Reversal Protection	X			
Phase Monitor	X			
Powered Exhaust				X
Powered or Unpowered Convenience Outlet		X		
Provisions for Through-the-Base Gas and Condensate Drain Connections	X			
Quick Adapt Curbs				X
Quick Access Panels	X			
Quick Adjust Fan Motor Mounting Plate	X			
Quick Start Kit				X
Reference or Comparative Enthalpy			X	
Remote Potentiometer				X
Roof Curb				X
Single Point Power	X			
Single Side Service	X			
Single Zone Variable Air Volume (SZVAV)		X		
Stainless Steel Drain Pan		X		
Standardized Components	X			
Supply, Return or Plenum Air Smoke Detector		X		
Thermal Expansion Valve	X			
Through-the-Base Condensate	X			
Through-the-Base Electrical Access		X		
Through-the-Base Electrical with Circuit Breaker		X		
Through-the-Base Electrical with Disconnect Switch		X		
Ventilation Override Accessory				X
Vibration Isolators				X

(a) Refer to model number description for option availability.  
 (b) Option on 3 to 5 ton high efficiency units.  
 (c) Not available on microchannel coils.  
 (d) CO<sub>2</sub> sensor associated with demand control ventilation always field installed.  
 (e) Standard on: (T/Y)SC120H, (T/Y)HC074, 092,102F, (T/Y)HC120F. Optional on: (T/Y)SC092-102H.  
 (f) The microchannel type condenser coil is standard for T/YSC(072,090,092,102,120)H, T/YHC(048,060,072,074, 092,102,120)F and (T/Y)SC (036,048,060)G models.

# Precedent Packaged Systems Features and Benefits

**Table 2. Precedent™ control options – standard and optional**

	Standard Features	Options <sup>(a)</sup>		
		Factory Installed	Factory or Field Installed	Field Installed
Dual Thermistor Remote Zone Sensor				X
Electromechanical or ReliaTel™ Microprocessor Controls	X			
Human Interface		X		
Humidity Sensor/Humidistat				X
Thermostat				X
Wireless Zone Sensor				X
Zone Sensor				X
BACnet® Communication Interface (BCI)			X	
LonTalk® Communication Interface (LCI)			X	
American Standard® Air-Fi® Wireless Communication Interface		X		
American Standard® Communication Interface			X	

**Note:** For more information, reference the Controls chapter.

<sup>(a)</sup> Refer to model number description for option availability.

## Standard Features

### Anti-Short Cycle Timer

Provides a 3 minute minimum “ON” time and 3 minute “OFF” time for compressors to enhance compressor reliability by assuring proper oil return.

### Colored And Numbered Wiring

Save time and money tracing wires and diagnosing the unit.

### Compressors

Precedent™ contains the best compressor technology available to achieve the highest possible performance. Dual compressors are outstanding for humidity control, light load cooling conditions and system back-up applications. Dual compressors are available on 6 to 10 tons models and allow for efficient cooling utilizing 3-stages of compressor operation (high efficiency models only).

### Condenser Coil

Precedent™ boasts a patent-pending 1+1+1 condenser coil, permanently gapped for easy cleaning.



### Controls – ReliaTel™ or Electromechanical

ReliaTel™ microprocessor controls provide unit control for heating, cooling and ventilating utilizing input from sensors that measure indoor and outdoor temperature and other zone

# Precedent Packaged Systems Features and Benefits

sensors. ReliaTel™ also provides outputs for building automation systems and expanded diagnostics. For a complete list of ReliaTel™ offerings, refer to the “Other Benefits” section within the Features and Benefits section of this catalog.

For the simpler job that does not require a building automation system, or expanded diagnostics capabilities, Precedent™ offers electromechanical controls. This 24-volt control includes the control transformer and contactor pressure lugs for power wiring.

## Convertible Units

Units ship in a downflow configuration and can be easily converted to horizontal by simply moving two panels.

Units come complete with horizontal duct flanges so the contractor doesn't have to field fabricate them. These duct flanges are a time and cost saver.



## Crankcase Heaters

These band heaters provide improved compressor reliability by warming the oil to prevent migration during off-cycles or low ambient conditions.

## Direct Drive Motors

For additional static requirements, single-phase units offer multi-speed, direct drive motors. All 10 ton units and 6 to 8.5 ton high efficiency units offer variable speed direct drive motors.

## Direct Drive Plenum Fan

The following units are equipped with a direct drive plenum fan design (all 10 ton units, 6 (074) to 8.5 ton high efficiency units, and optional on 7.5 (092) to 8.5 ton standard efficiency units). Plenum fan design includes a backward-curved fan wheel along with an external rotor direct drive variable speed indoor motor. All plenum fan designs have a variable speed adjustment potentiometer located in the control box.

**Note:** Standard on: (T/Y)SC120H, (T/Y)HC074, 092, 102F, (T/Y)HC120F. Optional on (T/Y)SC092, 102H.

## Drain Pan

Every Precedent™ unit has a plastic, removable, dual-sloped drain pan (IAQ) that's easy to clean and reversible to allow installation of drain trap on either side of the unit.



# Precedent Packaged Systems Features and Benefits

## Easy Access Low Voltage Terminal Board

The low voltage terminal board is external to the electrical control cabinet. It is extremely easy to locate and attach the thermostat wire and test operation of all unit functions. This is another cost and time saving installation feature.

## Foil Faced and Edge Captured Insulation

All panels in the evaporator section of the unit have cleanable foil-faced insulation. All edges are either captured or sealed to ensure no insulation fibers get into the airstream.

## Heat Exchanger

The compact cabinet features a progressive tubular heat exchanger in low, medium and high heat capacities.

The heat exchanger is fabricated using corrosion-resistant aluminized steel tubes and burners as standard on all models. It has an induced draft blower to pull the gas mixture through the burner tubes. The heater has a direct spark ignition system which doubles as a safety device to prove the flame.

## Low Ambient Cooling

All Precedent™ microprocessor units have cooling capabilities down to 0°F as standard. Electromechanical models have cooling capabilities to 40°F as built, or to 0°F by adding the optional low ambient control (Frostat™).

## Low Voltage Connections

The wiring of the low voltage connections to the unit and the zone sensors is as simple as 1-1, 2-2, and 3-3. This simplified system makes it easy for the installer to wire.

## Microchannel Condenser Coil

Microchannel condensing coils are all-aluminum coils with fully-brazed construction. This design reduces risk of leaks and provides increased coil rigidity — making them more rugged on the jobsite. Their flat streamlined tubes with small ports and metallurgical tube-to-fin bond allow for exceptional heat transfer. Microchannel all-aluminum construction provides several additional benefits:

- Light weight (simplifies coil handling)
- Easy to recycle
- Minimize galvanic corrosion

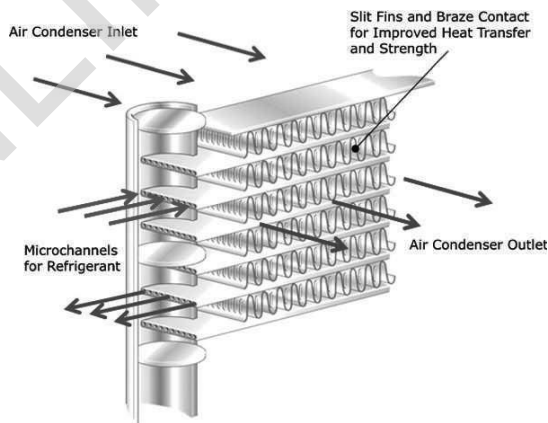

# Precedent Packaged Systems Features and Benefits

---

## Phase Monitoring Protection

Precedent™ units with 3-phase power are equipped with phase monitoring protection as standard. These devices protect motors and compressors against problems caused by phase loss, phase imbalance and phase reversal indication.

## Quick Access Panels

Remove two screws for access to the standardized internal components and wiring.

## Standardized Components

Components are placed in the same location on all units. Due to standardized components throughout the line, contractors/owners can stock fewer parts.

## Through-the-Base Condensate

Every unit includes provisions for through-the-base condensate drain connections. This allows the drain to be connected through the roof curb instead of a roof penetration.

## Other Benefits

- Cabinet design ensures water integrity
- Ease of Service, Installation and Maintenance
- Mixed model build enables “fastest in the industry” ship cycle times
- Outstanding Airflow Distribution
- ReliaTel™ Controls

## Factory Installed Options

### Belt Drive Motors

For additional static requirements, Precedent™ 3 to 5 tons, high efficiency (15 SEER) units offer an optional belt drive motor to meet a wide range of airflow needs.

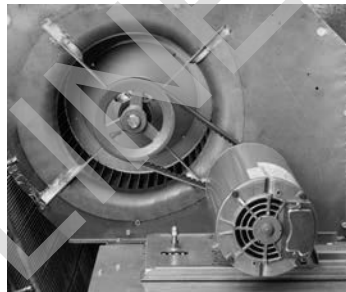

*Note: Available for three-phase units only.*

### Black Epoxy Pre-Coated Coils

The pre-coated coils are an economical option for protection in mildly corrosive environments.

*Note: Not available on microchannel condenser coils.*

### Circuit Breaker

This option is a factory installed thermal magnetic, molded case, HACR circuit breaker with provisions for through-the-base electrical connections.

*Note: Available on units equipped with through-the-base electrical.*



# Precedent Packaged Systems Features and Benefits



## Disconnect Switch

**Note:** Available on units equipped with through-the-base electrical.

Factory installed 3-pole, molded case, disconnect switch for through-the-base electrical connections.

Codes require a method of assured unit shutdown for servicing. Field-installed disconnects sometimes interfere with service access. Factory installation of unit disconnects reduces costs, assures proper mounting and provides the opportunity to upgrade to unit circuit breaker protection.

## Convenience Outlet

This option is a GFCI, 120V/15amp, 2 plug, convenience outlet, either powered or unpowered. This option can only be ordered when through-the-base electrical with either the disconnect switch or circuit breaker option is ordered.



**Note:** Convenience outlet not available on 575V units or 3 to 5 ton high efficiency units with direct drive indoor motor.

## CO<sub>2</sub> Sensor Wiring

This is the unit wiring for field installed CO<sub>2</sub> sensors. Factory-installed CO<sub>2</sub> sensor wiring saves time and ensures proper unit connections for the field installed CO<sub>2</sub> sensor kits.

## CompleteCoat™ Condenser Coil

These coils provide excellent corrosion resistance as well as uniformity of coverage and coating thickness. This option is available for both fin-tube and microchannel condenser coils.

## Condensate Overflow Switch

A condensate overflow switch is available to shut the unit down in the event that the condensate drain becomes clogged. This option protects the unit from water overflowing from the drain pan and entering the base of the unit.

## Dehumidification (Hot Gas Reheat)

This option allows for increased outdoor air ventilation. It reduces humidity levels while increasing comfort level in the air space. Cooling can operate without a demand for dehumidification. The hot gas reheat coil is designed to deliver maximum reheat temperatures.

## Precedent Packaged Systems Features and Benefits



### Fault Detection and Diagnostics (FDD)

This offering meets the mandatory requirement of CA Title 24 of fully configurable diagnostics allowing fault history and reading fault codes at the unit. This option provides detection of the following faults: Air temperature sensor failure/fault and notification of acceptable economizer mode. The FDD system shall be certified by the Energy Commission as meeting the requirements.

### Human Interface



The 5 inch color touchscreen human interface provides an intuitive user interface to the rooftop unit that speeds up unit commissioning, shortens unit troubleshooting times, and enhances preventative maintenance measures. The human interface includes several features such as:

- Data trending capabilities by means of time series graphs
- Historical alarm messages
- Real-time sensor measurements
- On board system setpoints
- USB port that enables the downloading of component runtime information as well as trended historical sensor data
- Customized reports

**Note:** Refer to RT-SVX49\*-EN for additional information.

### High Efficiency Filtration

Precedent™ units offer a variety of high efficiency filtration options. MERV 8 and MERV 13 filters provide additional filtration beyond the capabilities of typical 2" throwaway filters. Also, when MERV 8 or MERV 13 filters are ordered, units come equipped with a filter removal tool.

# Precedent Packaged Systems Features and Benefits

## Hinged Access Doors

These doors permit easy access to the filter, fan/heat and compressor/control sections. They reduce the potential roof damage from screws or sharp access door corners.



## Multi-Speed Indoor Fan System

Multi-speed indoor fan system is designed for use in applications for meeting the minimum requirement of CA Title 24.

This system incorporates a multi-speed fan control to change the speed of the fan to 66% of full airflow based off of compressor stages.

## Multiple-Zone VAV Control

A multiple-zone VAV (MZVAV) system consists of a packaged rooftop unit that serves several individually controlled zones. Each zone is equipped with a VAV terminal unit that varies the quantity of air delivered to maintain the desired temperature in that zone. The rooftop unit controller varies the speed of the indoor fan to maintain the static pressure in the supply ductwork at a setpoint, ensuring that all zones receive the necessary quantity of air. In addition, cooling capacity is cycled to maintain the supply air temperature at the desired setpoint.

For decades, American Standard has been an industry leader in rooftop VAV systems. Now, multiple-zone VAV control is available in the light commercial rooftop platform (3 to 25 tons).

## Novar Unit Controls

Novar 3051 and 2024 are available for Precedent™ gas and electric heat models.

## Single Zone VAV (SZVAV)

Single Zone VAV (SZVAV) is designed for use in single zone applications such as gymnasiums, auditoriums, manufacturing facilities, retail box stores, and any large open spaces where there is a diversity in the load profile. It is an ideal replacement to "yesterday's" constant-volume (CV) systems, as it reduces operating costs while improving occupant comfort.

SZVAV systems combine American Standard application, control and system integration knowledge to exactly match fan speed with cooling and heating loads, regardless of the operating condition. American Standard algorithms meet and/or exceed ASHRAE 90.1 SZVAV energy-saving recommendations and those of CA Title 24. The result is an optimized balance between zone temperature control and system energy savings. Depending on your specific application, energy savings can be as much as 20+%.

**Note:** Building system modeling in energy simulation software such as TRACE is recommended to evaluate performance improvements for your application.

SZVAV is fully integrated into the control system. It provides the simplest and fastest commissioning in the industry through proven factory-installed, wired, and tested system controllers. All control modules, logic boards and sensors are factory installed and tested to ensure the highest quality and most reliable system available. This means no special programming of algorithms, or hunting at the jobsite for field installed sensors, boards, etc. SZVAV is a quick and simple solution for many applications and is available from your most trusted rooftop VAV system solution provider -American Standard.

**Note:** Only available on 7.5 to 20 tons units.

# Precedent Packaged Systems Features and Benefits

## Stainless Steel Drain Pan

For excellent corrosion and oxidation resistance, the optional stainless steel drain pan provides a cleanable surface that complement other IAQ solutions such as high efficiency filtration (MERV 8 or 13), demand control ventilation (CO<sub>2</sub>), and hot gas reheat.

## Stainless Steel Heat Exchanger

The optional stainless steel heat exchanger is constructed of 409 stainless steel tubes and 439 stainless steel burners. It is resistant to corrosion and oxidation and easy to clean. The high strength to weight ratio allows for high ventilation rates with gas units. It is an excellent option to compliment the dehumidification option as a high outside air ventilation unit. With this option, a 10-year stainless steel heat exchanger warranty is standard.

## Supply, Return, and Plenum Air Smoke Detector

With this option installed, if smoke is detected, all unit operation will be shut down. Reset will be manual at the unit. In order for the supply air smoke detector or return air smoke detector to properly sense smoke in the supply air stream or the return air stream, the air velocity entering the smoke detector unit must be between 500 - 4000 feet per minute. Equipment covered in this manual will develop an airflow velocity that falls within these limits over the entire airflow range specified in the evaporator fan performance table. Supply and/or return smoke detectors may not be used with the plenum smoke detector.

Figure 1. Supply/Return air smoke detector



Figure 2. Plenum Air Smoke Detector



**Note:** Plenum smoke detectors have no auxiliary contacts for external connections.

## Through-the-Base Gas Access

Factory provided through-the-base openings simplify wiring and piping. Because these utility openings frequently minimize the number of roof penetrations, the integrity of roofing materials is enhanced.



## Through-the-Base Electrical Access

An electrical service entrance shall be provided allowing electrical access for both control and main power connections inside the curb and through-the-base of the unit. Option will allow for field installation of liquid-tight conduit and an external field installed disconnect switch.

# Precedent Packaged Systems Features and Benefits



## Factory or Field Installed Options

### Barometric Relief

Designed to be used on downflow units, barometric relief is an unpowered means of relieving excess building pressure.

### Clogged Filter/Fan Failure Switch

A dedicated differential pressure switch is available to achieve active fan failure indication and/or clogged filter indication.

These sensors allow a zone sensor service light or Integrated Comfort System to indicate a dirty filter or a fan that's not working. The field installation charges for these valuable feedback devices often eliminate them from consideration. Factory installation can make such features a good investment.

### Discharge Air Temperature Sensing Kit

Provides true discharge air temperature sensing in heating models. This sensor is a status indicator readable through Tracer® or Tracker™. The kit is functional only with the ReliaTel™ options module.

### Economizer (Standard)

This standard economizer accessory shall be available with or without barometric relief. The assembly includes fully modulating 0-100 percent motor and dampers, minimum position setting, preset linkage, wiring harness with plug, spring return actuator and fixed dry bulb control. The barometric relief shall provide a pressure operated damper that shall be gravity closing and shall prohibit entrance of outside air during the equipment "off" cycle. Optional solid state or differential enthalpy control shall be available for either factory or field installation. The economizer arrives in the shipping position and shall be moved to the operating position by the installing contractor.

### Electric Heaters

Electric heat modules are available within the basic unit. If ordering the through-the-base electrical option with an electrical heater, the heater must be factory installed.

### Fresh Air — Dampers and Economizer

0 - 25% manual or 0 - 50% motorized outside air hoods are available.

Economizers are equipped with either dry bulb or reference or comparative enthalpy sensing. These economizers provide free cooling as the outdoor temperature and/or humidity decreases. Correctly installed, they offer a valuable energy savings. Factory-installed economizers save time and ensure proper installation.

### Frostat™

This capillary bulb embedded in the face of the evaporator coil or thermostat on the suction line monitors coil temperature to prevent evaporator icing and protect the compressor.

# Precedent Packaged Systems Features and Benefits

---

Recommended for applications with low leaving air temperatures, low airflow and or high latent load applications.

**Note:** Frostat™ is standard on all single-zone and multiple-zone VAV models.

## Hail Guards

Hail protection quality coil guards protects the condenser coil from vandalism and/or hail damage.

## Low Leak Economizer

This accessory meets low leak requirements for ASHRAE 90.1, IECC, and CA Title 24 standards (4 cfm/ft<sup>2</sup>@1" wg exterior air/return air). This option allows 100% outdoor air supply from 0-100% modulating dampers and is standard with barometric relief. It can be paired with powered exhaust for additional building pressure relief. This option can be paired with or without fault detection & diagnostics (FDD) to meet current mandatory CA Title 24 requirements.

The economizers come with three control options, dry bulb and reference or comparative enthalpy (optional).

**Note:** Low leak economizers available on downflow units only.

## Reference or Comparative Enthalpy

Measures and communicates humidity while maximizing comfort control.

## Field Installed Options

### CO<sub>2</sub> Sensor — Demand Control Ventilation (DCV)

Demand-controlled ventilation (DCV) is a control strategy that responds to the actual demand (need) for ventilation by regulating the rate at which the HVAC system brings outdoor air into the building. A CO<sub>2</sub> sensor measures the concentration (parts per million, ppm) of CO<sub>2</sub> (carbon dioxide) in the air. As the CO<sub>2</sub> concentration changes, the outside air damper modulates to meet the current ventilation needs of the zone. The CO<sub>2</sub> sensor kit is available as a field installed accessory. Two field installed kits are offered; CO<sub>2</sub> sensor and wiring or CO<sub>2</sub> sensor only. The CO<sub>2</sub> Sensor only kit should be ordered with factory installed CO<sub>2</sub> sensor wiring. Factory installed CO<sub>2</sub> sensor wiring saves set-up time and ensures proper unit connections for the CO<sub>2</sub> sensor.

### High Altitude Kit

While recommended for units applied above 2,000 feet, domestic contractors should consult with local authority on best practice. High altitude kits contain gas orifices that derate the gas input rate (Btuh/r) by 10%.

### High Static Drive

Available on many models, this high static drive accessory extends the capability of the standard motor. Avoid expensive motors and operating costs by installing this optimized sheave accessory.

### Humidity Sensor/Humidistat

The humidity sensor/humidistat, when used in conjunction with our dehumidification (hot gas reheat) units will provide outstanding humidity control and comfort. Humidity sensors can be wall or duct mounted. The humidity deadband can be set between 40% and 60% relative humidity.

### Low Leak Economizer — Field Installed

This accessory meets low leak requirements for ASHRAE 90.1, IECC, and CA Title 24 standards (4 cfm/ft<sup>2</sup>@1" wg exterior air/return air). This option allows 100% outdoor air supply from 0-100% modulating dampers and is standard with barometric relief. It can be paired with powered exhaust for additional building pressure relief.

# Precedent Packaged Systems Features and Benefits

---

*Note: Available on downflow units only.*

## LP Conversion Kit

Provided for field conversion of gas/electric units from natural gas to propane.

## Outside Air Measuring/Monitoring Control (Traq Dampers)

Quantity of fresh air entering the unit will be measured and monitored via American Standard UC400 controller and series of pressure sensing rings mounted at the outside air intake.

## Quick Adapt Curbs

Enables easy conversion of existing Voyager™ 3 to 10 ton units to Precedent™ units on replacement jobs.

## Quick Start Kits

Single phase equipment to enable startup and prevent building lighting dimming during low voltage.

## Roof Curbs

Available for downflow units. Only three roof curbs for the entire line simplifies curb selection.

## Remote Potentiometer

When properly installed in the economizer control circuitry, this accessory provides a remote variable resistance to enable the operator to adjust the minimum damper position.

## Ventilation Override Accessory

With the ventilation override accessory installed, the unit can be set to transition to up to 3 different pre-programmed sequences for smoke purge, pressurization, and exhaust. The transition occurs when a binary input on the RTOM is closed (shorted). This would typically be a hard wired relay output from a smoke detector or fire control panel. The ventilation override kit is available as a field installed accessory.

## Other Benefits

### Airflow Distribution

Airflow is outstanding. Precedent™ can replace an older machine with old ductwork and, in many cases, improve the comfort through better air distribution.

### Cabinet Integrity

For added water integrity, Precedent™ has a raised 1 1/8" lip around the supply and return of the downflow units to prevent water from blowing into the ductwork.

The compact cabinet with rounded corners takes up less room. The beveled and ribbed top is aesthetically pleasing and designed to prevent water from pooling.



# Precedent Packaged Systems Features and Benefits

## Flexibility

Precedent™ offers ultimate flexibility. Units are built to order in our standard “shortest in the industry” ship cycle time.

## Rigorous Testing

All of the Precedent™ designs were rigorously rain tested at the factory to ensure water integrity.

Actual shipping tests were performed to determine packaging requirements. Units were test shipped around the country to determine the best packaging design. Factory shake and drop tests were used as part of the package design process to help assure that the unit arrives at the job site in top condition.

Rigging tests include lifting a unit into the air and letting it drop one foot, assuring that the lifting lugs and rails hold up under stress.

We perform a 100% coil leak test at the factory. The evaporator and condenser coils are leak tested at 600 psig. The assembled unit is leak tested to 465 psig.

All parts are inspected at the point of final assembly. Sub-standard parts are identified and rejected immediately.

Every unit receives a 100% unit run test before leaving the production line to make sure it meets rigorous requirements.

## Easy to Install, Service and Maintain

Because today’s owners are very cost-conscious when it comes to service and maintenance, this unit was designed with direct input from service contractors. This valuable information helped to design a product that would get the service technician off the job quicker and save the owner money. This product line offers outstanding standard features enhanced by a variety of factory and field installed options, multiple control options, rigorously tested proven designs and superior product and technical support.

## ReliaTel™ Controls

Figure 3. ReliaTel board

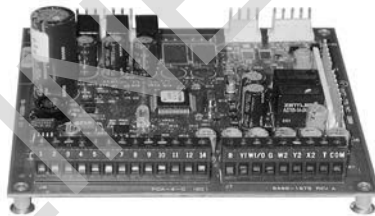

ReliaTel controls provide unit control for heating, cooling, and ventilating, utilizing input from sensors that measure outdoor and indoor temperature. ReliaTel also provides outputs for building automation systems and expanded diagnostics. Quality and reliability are enhanced through ReliaTel control and logic:

- Prevents the unit from short cycling, considerably improving compressor life.
- Ensures the compressor will run for a specific amount of time which allows oil to return for better lubrication, enhancing the reliability of the compressor.
- Reduces the number of components required to operate the unit, reducing possibilities for component failure.

## ReliaTel Makes Installing and Servicing Easy

ReliaTel eliminates the need for field-installed, anti-short cycle timer and time delay relays. The wiring of the low voltage connections to the unit and the zone sensors is as easy as 1-1, 2-2, and 3-3. This simplified system makes wiring easier for the installer.



# Precedent Packaged Systems Features and Benefits

---

## ReliaTel Makes Testing Easy

ReliaTel requires no special tools to run the unit through its paces. Simply place a jumper between Test 1 and Test 2 terminals on the Low Voltage Terminal Board and the unit will walk through its operational steps automatically. The unit automatically returns control to the zone sensor after stepping through the test mode a single time, even if the jumper is left on the unit. As long as the unit has power and the “system on” LED is lit, ReliaTel is operational. The light indicates that the controls are functioning properly. ReliaTel features expanded diagnostic capabilities when utilized with American Standard Integrated Comfort™ Systems. Some zone sensor options have central control panel lights which indicate the mode the unit is in and possible diagnostic information (dirty filters for example).

## ReliaTel Has Other Benefits

- The ReliaTel built-in anti-shortcycle timer, time delay relay and minimum “on” time control functions are factory tested to assure proper operation.
- ReliaTel softens electrical “spikes” by staging on fans, compressors and heaters.
- Intelligent Fallback is a benefit to the building occupant. If a component goes astray, the unit will continue to operate at predetermined temperature setpoint.
- Intelligent Anticipation is a standard feature. It functions continuously as ReliaTel and zone sensor(s) work together in harmony to provide much tighter comfort control than conventional electromechanical thermostats.
- The ReliaTel design is standardized across the board, ensuring a lower cost to owners.

# Precedent 3-10 Ton Packaged Cooling Application Considerations

Application of this product should be within the cataloged airflow and cooling considerations.

## Barometric Relief

This product line offers an optional barometric relief damper for use in conjunction with economizer option. This accessory consists of gravity dampers which open with increased pressure. As the building air pressure increases, the pressure in the unit return air section also increases, opening the dampers and relieving the conditioned space.

**Note:** *The effectiveness of barometric relief damper during economizing operation is limited, depending on the pressure drop of the return-air path. For some applications, powered exhaust may be better suited for preventing over-pressurization when economizing.*

## Black Epoxy Coil

The coils are manufactured with a thermoset, vinyl coating that is bonded to the aluminum fin stock prior to the fin stamping process. These coils are an economical option for protection in mildly corrosive environments.

**Notes:**

- *Not to be used where seacoast applications exist.*
- *Not available on microchannel condenser coils.*

## Clearance Requirements

The recommended clearances identified with unit dimensions should be maintained to assure adequate service maximum capacity and peak operating efficiency. Actual clearances which appear inadequate should be reviewed with the local American Standard sales personnel.

Model Number	Clearance required from duct to combustible surfaces (inches)
TSC036G	0
THC036E	1
TSC048G	0
THC048E,F	0
TSC060G	0
THC060E,F	0
TSC072H	0
THC072F	1
THC074F	1
TSC090H	1
TSC092H	0
THC092F	1
TSC102H	0
THC102F	1
TSC120H	1
THC120F	1

## CompleteCoat™ Condenser Coil

The coils provide protection from corrosive environments and are ideal for seacoast applications.

# Precedent 3-10 Ton Packaged Cooling Application Considerations

---

## Condensate Trap

The evaporator is a draw-thru configuration. A trap must be field provided prior to start-up on the cooling cycle.

## Heating Operation

The heat exchanger is manufactured with aluminized steel. To prevent condensation within the heat exchanger, do not exceed 50% outside air or a minimum mixed air temperature of 40°F.

## Low Airflow Operation

Units equipped electric heat or staged gas heat may not be selected for supply airflow less than 320 cfm/ton. Cooling-only units can be used in applications designed for supply airflow below 320 cfm/ton. The units must be high-efficiency models with dehumidification (hot gas reheat) or be equipped with a TXV, Froststat™, and crankcase heaters.

Units selected with multiple-speed indoor fan control, single-zone VAV control, or multiple-zone VAV control are capable of operating at supply airflows below 320 cfm/ton at part-load conditions, but design (or "full") airflow must be set to 320 cfm/ton or higher.

## Low Ambient Cooling

The Precedent™ line features, with ReliaTel™ microprocessor controls, low ambient cooling down to 0°F. With electromechanical controls, Precedent™ features low ambient cooling to 40°F. The following features or options need to be included/considered when low ambient applications are required: continuous fan operation, crankcase heaters, thermal expansion valves, Froststat™.

Contact a local American Standard representative for more assistance with low ambient cooling applications.

## Optional Stainless Steel Heat Exchanger

The optional stainless steel heat exchanger is manufactured with 409 stainless steel tubes and 439 stainless steel burners. To prevent corrosion and prolong heat exchanger reliability, the minimum mixed air temperature allowed across the heat exchanger is 20°F.

The stainless steel heat exchanger option is an excellent option that compliments the dehumidification package. Whenever high outside air or outside applications exist, these options should be utilized.

## Unit Pitch

The unit has a reversible sloped condensate drain pans. The unit must be installed level. Any unit slope must be toward the side of unit where condensate drain is connected.

# Precedent 3-10 Ton Packaged Cooling Selection Procedure

## Cooling Capacity

**Note:** Cooling capacity procedure is the same for electric heat (T\*C) and gas heat (Y\*C).

- Calculate the total and sensible cooling loads for the building at design conditions. Use the American Standard calculation methods or any other standard accepted method.  
 Factors used in unit selection:
  - Packaged Cooling with Optional Electric Heat
  - Total Cooling Load: 57 MBh
  - Sensible Cooling Load: 40 MBh
  - Airflow: 2000 cfm
  - Electrical Characteristics: 460/60/3
  - Summer Design Conditions: Entering Evaporator Coil: 80°F DB/67°F WB
  - Outdoor Ambient: 95°F
  - External Static Pressure: 0.34 in. wg
  - Downflow Configuration
  - Efficiency: 14 SEER
  - Economizer
- As a starting point, a rough determination must be made of the size of the unit. The final selection will be made after examining the performance at the given conditions. Divide the total cooling load by nominal Btuh per ton (12 MBh per ton); then round up to the nearest unit size.  
 $59 \text{ MBh} / 12 \text{ MBh} = \text{approx. } 5 \text{ tons}$
- Table 10, p. 40 shows that a TSC060G4 has a gross cooling capacity of 60 MBh and 49 MBh sensible capacity at 2000 cfm and 95°F DB outdoor ambient with 80°F DB, 67°F WB air entering the evaporator.

### Find capacity at intermediate conditions not in the table

When the design conditions are between two numbers that are in the capacity table, interpolation is required to approximate the capacity.

**Note:** Extrapolation outside of the table conditions is not recommended.

- In order to select the correct unit which meets the building's requirements, the fan motor heat must be deducted from the gross cooling capacity. The amount of heat that the fan motor generates is dependent on the effort by the motor - cfm and static pressure. To determine the total unit static pressure take into account the following information.

External Static Duct System	0.34 wg
Standard Filter 2 in. from Table 148, p. 183	0.06 wg
Economizer from Table 148, p. 183 (100% Outside Air) *worst case	0.18 wg
Electric Heater Size 6 kW from Table 154, p. 187	0.06 wg
Total Static Pressure	0.64 wg

**Note:** Reference heating capacity section on this page for determination of heater size.

**Note:** The evaporator fan performance has deducted the pressure drop for a filter already in the unit. Therefore, the actual total static pressure is  $0.515 - 0.06 = 0.466 \text{ wg}$ .

With 2000 cfm and 0.47 wg, p. 70 shows 0.58 bhp for this unit.

**Note:** Below the table is the formula to calculate fan motor heat.

# Precedent 3-10 Ton Packaged Cooling Selection Procedure

$$2.87 \times \text{bhp} + 0.15 = \text{MBh}$$

$$2.87 \times 0.575 + 0.15 = 1.8 \text{ MBh}$$

Now subtract the fan motor heat from the gross cooling capacity of the unit:

$$\text{Net Total Cooling Capacity} = 60 \text{ MBh} - 1.8 = 58.2 \text{ MBh}$$

$$\text{Net Sensible Cooling Capacity} = 49 \text{ MBh} - 1.8 = 47.2 \text{ MBh}$$

Subtract sensible from total capacity to find latent capacity

$$\text{Net Latent Capacity} = 60.5 - 46.3 = 11 \text{ MBh}$$

- Compare your resulting capacities to the building load. If the performance will not meet the required load of the building's total or sensible cooling load, try a selection at the next higher size unit.

## Heating Capacity

**Note:** Heating capacity procedure DIFFERS for electric heat (T°C) and gas heat (Y°C).

- Calculate the heating loads for the building at design conditions. Use the American Standard calculation methods or any other standard accepted method.
- Size the system heating capacity to match the calculated building heating load. The following are building heating requirements:

Total heating load of 15 MBh

2000 cfm

T°C units with optional electric heat: 460V/3 phase power supply

A 6 kW heater will deliver 20.48 MBh at 480 volts. In order to determine capacity at 460 volts, the heater voltage correction factor must be used. Therefore, 20.48 MBh x 0.918 (voltage correction factor) = 18.8 MBh.

Y°C units with gas heat: Fuel - natural gas.

60 MBh, 80 MBh, 120 MBh, and 130 MBh input models. The output capacities of these furnaces are 49.2 MBh, 65.6 MBh, 98.4 MBh, and 106.6 MBh respectively. The low heat model with 49.2 MBh best matches the building requirements.

## Air Delivery Selection

**Note:** Air delivery procedure is the same for electric heat and gas heat units.)

External static pressure drop through the air distribution system has been calculated to be 0.5 inches of water. For a TSC060G4 at 2000 cfm and 0.47 static pressure, the standard direct drive motor will give the desired airflow at a rated bhp of 0.58 and 924 rpm.

## Dehumidification Selection

**Note:** Dehumidification selection procedure is the same for both electric heat (THC) and gas heat (YHC) models.

Typical 5 ton THC060E	OA Conditions	RA conditions
2000 cfm Total Supply Airflow	Part load day and raining	75°F db
800 cfm Outside Air (40%)	68°F db	63°F wb
1200 cfm Return Air	67°F wb	
0.34" External Static Pressure	95% RH	

- Determine the mixed/entering air condition (MA)

MA = (% outside air\*outside air dry-bulb temperature) + (% return air\*return air dry-bulb temperature)

# Precedent 3-10 Ton Packaged Cooling Selection Procedure

$$MA = (0.40 \times 68^\circ\text{F}) + (0.60 \times 75^\circ\text{F})$$

$$MA = 72.20^\circ\text{F db}$$

Repeat for wet-bulb temperature (wb)

$$MA = 72.2^\circ\text{F db}$$

$$64.6^\circ\text{F wb}$$

- Determine the additional static pressure drop for a reheat unit.

A static pressure drop of 0.13" for the reheat coil and an additional 0.08 for the mandatory 2" pleated filters required when ordering the dehumidification option. Total static pressure = .34 + 0.08 + 0.13 = 0.55

**Note:** Do not forget to also add any additional static from other accessories. This selection does not include additional accessories.

A standard motor and drive is needed for this airflow and static pressure range.

- Determine leaving evaporator temperature (SA')

$$\text{Leaving Evaporator Temperature} = SA'$$

Utilizing the manual **Cooling Capacity** selection method as previously described, find the leaving evaporator temperatures with the following formula:

$$\Delta \text{Temp} = \frac{\text{gross sensible or gross latent cooling capacity in Btuh}}{(\text{cfm}) (1.085)}$$

Subtract your sensible  $\Delta$  temp from the entering db and latent  $\Delta$  temp from the entering wb to determine the leaving evaporator db & wb (temperatures without the addition of fan heat).

$$52.7^\circ\text{F db}$$

$$52.7^\circ\text{F wb}$$

$$52.7^\circ\text{F dp}$$

- Determine leaving unit temperature in standard cooling mode.

Repeat Step 3. substituting **net** sensible or latent capacity for **gross** sensible or latent capacity to find the leaving unit temperature including fan heat.

$$53.7^\circ\text{F db}$$

$$53.1^\circ\text{F wb}$$

- Determine reheat temperature rise.

Using the leaving evaporator temp (SA') determine the reheat temperature rise for that particular cfm: +/- 9.0°F db.

**Note:** Reheat temperature rise is based on **supply airflow** and leaving evaporator coil temperature.

- Determine leaving unit sensible temperature *with reheat active* (SA)

$$\text{Reheat temperature (obtained in Step 5} + (\text{SA}' + \text{fan heat}) = \text{SA}$$

**Note:** (SA' + fan heat) = leaving unit temperature in standard cooling mode from Step 4.

$$19.0^\circ\text{F db} + 53.7^\circ\text{F} = 72.7^\circ\text{F db}$$

$$SA = 72.7^\circ\text{F}$$

Since reheat adds only sensible heat, the dewpoint temperature will remain constant so follow the dewpoint temperature line across the psychrometric chart to find the new wb temperature.

$$\pm 60.5^\circ\text{F wb}$$

$$52.7 \text{ dp}$$

$$49.9\% \text{ RH}$$

## Precedent 3-10 Ton Packaged Cooling Selection Procedure

---

If the space relative humidity is equal to or above the space relative humidity setpoint, the dehumidification option will:

- Energize compressor or both compressors (2 stage compressor units).
- Hot gas reheat valve is energized and hot gas is diverted to the reheat coil.
- Dehumidification/reheat is terminated when space humidity is reduced to 5% below relative humidity setpoint.

As MA air enters the RTU. The RTU filters, cools, and dehumidifies the air as it moves through the evaporator coil. Air leaves the evaporator coil saturated at the preset dew point condition (SA') and is reheated by the hot gas reheat coil to deliver 72.7°F (SA) supply air to the space.

ONLINE ONLY COPY

# Precedent 3-10 Ton Packaged Cooling Model Number Description

## Digit 1 — Unit Type

**T** = DX Cooling  
**Y** = DX Cooling, Gas Heat

## Digit 2 — Efficiency

**S** = Standard Efficiency  
**H** = High Efficiency

## Digit 3 — Airflow

**C** = Convertible

## Digit 4,5,6 — Nominal Gross Cooling Capacity (MBh)

**036** = 3 Ton  
**048** = 4 Ton  
**060** = 5 Ton  
**072** = 6 Ton  
**074** = 6 Ton, Dual Compressor  
**090** = 7.5 Ton, Single Compressor  
**092** = 7.5 Ton, Dual Compressor  
**102** = 8.5 Ton  
**120** = 10 Ton

## Digit 7 — Major Design Sequence

## Digit 8 — Voltage Selection

**3** = 208-230/60/3  
**4** = 460/60/3  
**W** = 575/60/3

## Digit 9 — Unit Controls

**E** = Electromechanical  
**R** = ReliaTel™ Microprocessor

## Digit 10 — Heating

**Note:** *Applicable to Digit 1, T models only.*

**0** = No Electric Heat  
**B** = 6 kW (3 phase)  
**C** = 9 kW (3 phase)  
**E** = 12 kW (3 phase)  
**G** = 18 kW (3 phase)  
**J** = 23 kW (3 phase)  
**K** = 27 kW (3 phase)  
**N** = 36 kW (3 phase)  
**P** = 54 kW (3 phase)

## Digit 10 — Heating (continued)

**Note:** *Applicable to Digit 1, Y models only.*

**L** = Low Heat  
**M** = Medium Heat  
**H** = High Heat  
**X** = Low Heat, Stainless Steel Heat Exchanger  
**Y** = Medium Heat, Stainless Steel Heat Exchanger  
**Z** = High Heat, Stainless Steel Heat Exchanger

## Digit 11 — Minor Design Sequence

**A** = First Sequence<sup>3</sup>  
**B** = Second Sequence<sup>4</sup>

## Digit 12, 13 — Service Sequence

\*\* = Factory Assigned

## Digit 14 — Fresh Air Selection

**0** = No Fresh Air  
**A** = Manual Outside Air Damper 0-50%<sup>5</sup>  
**B** = Motorized Outside Air Damper 0-50%<sup>6</sup>  
**C** = Economizer, Dry Bulb 0-100% without Barometric Relief<sup>7</sup>  
**D** = Economizer, Dry Bulb 0-100% with Barometric Relief<sup>7</sup>  
**E** = Economizer, Reference Enthalpy 0-100% without Barometric Relief<sup>7,8</sup>  
**F** = Economizer, Reference Enthalpy 0-100% with Barometric Relief<sup>7,8</sup>  
**G** = Economizer, Comparative Enthalpy 0-100% without Barometric Relief<sup>7,8</sup>  
**H** = Economizer, Comparative Enthalpy 0-100% with Barometric Relief<sup>7,8</sup>  
**K** = Low Leak Economizer with Barometric Relief  
**M** = Low Leak Economizer with Barometric Relief  
**P** = Low Leak Economizer with Comparative Enthalpy with Barometric Relief

## Digit 15 — Supply Fan/Drive Type/Motor

**0** = Standard Drive<sup>9</sup>  
**1** = Oversized Motor  
**2** = Optional Belt Drive Motor<sup>10</sup>  
**6** = Single Zone VAV<sup>11,12</sup>  
**7** = Multi-Speed Indoor Fan<sup>13</sup>  
**E** = VAV Supply Air Temperature Controls Standard Motor<sup>12</sup>

## Digit 16 — Hinged Service Access/ Filters

**0** = Standard Panels/Standard Filters  
**A** = Hinged Access Panels/Standard Filters  
**B** = Standard Panels/2" MERV 8 Filters  
**C** = Hinged Access Panels/2" MERV 8 Filters  
**D** = Standard Panels/2" MERV 13 Filters  
**E** = Hinged Access Panels/2" MERV 8 Filters

## Digit 17 — Condenser Coil Protection

**0** = Standard Coil  
**1** = Standard Coil with Hail Guard  
**2** = Black Epoxy Coil Pre-Coated Condenser Coil<sup>14</sup>  
**3** = Black Epoxy Coil Pre-Coated Condenser Coil with Hail Guard<sup>14</sup>  
**4** = CompleteCoat™ with Condenser Coil  
**5** = CompleteCoat™ with Hail Guard

## Digit 18 — Through-the-Base Provisions

**Note:** *Applicable to Digit 1, T or Y models only.*

**0** = No Through-the-Base Provisions  
**A** = Through-the-Base Electric<sup>15</sup>

**Note:** *Applicable to Digit 1, Y models only.*

**B** = Through-the-Base Gas Piping<sup>16</sup>  
**C** = Through-the-Base Electric and Gas Piping<sup>16</sup>

## Digit 19 — Disconnect/Circuit Breaker (three-phase only)

**0** = No Disconnect/No Circuit Breaker  
**1** = Unit Mounted/Non-Fused Disconnect<sup>15</sup>  
**2** = Unit Mounted Circuit Breaker<sup>15</sup>

## Digit 20— Convenience Outlet

**0** = No Convenience Outlet  
**A** = Unpowered Convenience Outlet  
**B** = Powered Convenience Outlet (three-phase only)<sup>17</sup>

## Digit 21— Communications Options<sup>8</sup>

**0** = No Communications Interface  
**1** = American Standard® Communications Interface  
**2** = LonTalk® Communications Interface  
**3** = Novar 2024 Controls<sup>18</sup>  
**4** = Novar 3051 Controls without Zone Sensor<sup>18</sup>  
**5** = Novar 3051 Controls Interface with DCV<sup>18</sup>  
**6** = BACnet® Communications Interface  
**7** = American Standard® Air-Fi® Communications Interface<sup>19</sup>

## Digit 22— Refrigeration System Option

**0** = Standard Refrigeration System<sup>20</sup>  
**B** = Dehumidification Option<sup>21,22</sup>

## Digit 23— Refrigeration Controls

**Note:** *Applicable to Digit 7 = E, F, G, H.*

**0** = No Refrigeration Control<sup>23</sup>  
**1** = Frostat™<sup>24,25</sup>



# Precedent 3-10 Ton Packaged Cooling Model Number Description

## Digit 24— Smoke Detector<sup>26</sup>

- 0** = No Smoke Detector
- A** = Return Air Smoke Detector<sup>27,28</sup>
- B** = Supply Air Smoke Detector
- C** = Supply and Return Air Smoke Detectors<sup>27,28</sup>
- D** = Plenum Smoke Detector

## Digit 25— System Monitoring Controls

- 0** = No Monitoring Control<sup>29</sup>
- 1** = Clogged Filter Switch<sup>29</sup>
- 2** = Fan Filter Switch<sup>29</sup>
- 3** = Discharge Air Sensing Tube<sup>29</sup>
- 4** = Clogged Filter Switch and Fan Filter Switch<sup>29</sup>
- 5** = Clogged Filter Switch and Discharge Air Sensing Tube<sup>29</sup>
- 6** = Fan Failure Switch and Discharge Air Sensing Tube<sup>29</sup>
- 7** = Clogged Filter Switch, Fan Failure Switch and Discharge Air Sensing Tube<sup>29</sup>
- 8** = Novar Return Air Sensor (NOVAR 2024)<sup>30,18</sup>
- 9** = Novar Zone Temp Sensor (NOVAR 3051)<sup>31,18</sup>
- A** = Condensate Drain Pan Overflow Switch)
- B** = Clogged Filter Switch<sup>29</sup> and Condensate Drain Pan Overflow Switch
- C** = Fan Failure Switch<sup>29</sup> and Condensate Drain Pan Switch
- D** = Discharge Air Sensing<sup>29</sup> and Condensate Overflow Switch
- E** = Clogged Filter Switch<sup>29</sup>, Fan Failure Switch and Condensate Drain Pan Overflow Switch
- F** = Clogged Filter Switch<sup>29</sup>, Discharge Air Sensing Tube<sup>29</sup> and Condensate Drain Pan Overflow Switch
- G** = Fan Failure Switch, Discharge Air Sensing Tube<sup>29</sup> and Condensate Drain Pan Overflow Switch
- H** = Clogged Filter Switch<sup>29</sup>, Fan Failure Switch<sup>29</sup>, Discharge Air Sensing<sup>29</sup> and Condensate Drain Pan Overflow Switch

## Digit 26— System Monitoring Controls

- 0** = No Monitoring Control
- A** = Demand Control Ventilation (CO<sub>2</sub>)<sup>32,33</sup>
- B** = Low Leak Economizer with FDD (Fault Detection & Diagnostics)
- C** = FDD (Fault Detection & Diagnostics) with DCV (Demand Control Ventilation)

## Digit 27— Unit Hardware Enhancements

- 0** = No Enhancements
- 1** = Stainless Steel Drain Pan

## Digit 31— Advanced Unit Controls

- 0** = Standard Unit Controls
- 1** = Human Interface

# Precedent 3-10 Ton Packaged Cooling Model Number Description

## Model Number Notes

### Notes:

1. Standard on T/YSC 6, 7.5 (single and dual systems), 8.5, 10 ton standard efficiency models and T/YHC 4, 5, 6, 7.5, 8.5, 10 ton MCHH high efficiency models (except for 4, 5, 6 ton dehumidification models).
2. Available on 3 to 5 ton models.
3. Available for all models except gas/electric, 3 to 5 tons high efficiency single phase and 3 to 5 tons standard efficiency 3 phase.
4. Available for gas/electric, 3 to 5 tons high efficiency single phase and 3 to 5 tons standard efficiency single phase models.
5. Manual outside air damper will ship factory supplied within the unit, but must be field installed.
6. Motorized outside air damper is not available on multi-speed or SZVAV (single zone variable air volume) products.
7. Economizer with barometric relief is for downflow configured units only. Order economizer without barometric relief for horizontal configuration. Barometric relief for horizontal configured units must be ordered as field installed accessory.
8. Not available with electromechanical controls.
9. Multi-speed, direct drive motor with no belt drive option is standard on 3 to 5 ton, standard efficiency, 13/14 SEER units. Multi-speed, direct drive motor with a belt drive option is available for 3 to 5 ton, 15 SEER units. On 6 to 10 tons, multispeed direct drive is standard on all 10 ton and 6 (074) to 8.5 ton high efficiency. Belt drive is standard on all other units. Reference Table 3, p. 28 table.
10. Reference Table 3, p. 28 table.
11. Single zone VAV is only available on 6 to 10 tons high efficiency and 7.5 to 10 ton standard efficiency products with ReliaTel™ controls.
12. Discharge air sensing is also standard equipment on units with single zone and supply air temperature control VAV.
13. Multi-speed indoor fan available only on 6, 7.5 & 8.5 tons high efficiency, and 7.5 to 10 ton products with ReliaTel™ controls.
14. Epoxy coil and epoxy with hail guard options are not available for units with microchannel condenser coil.
15. Through-the-base electric required when ordering disconnect/circuit breaker options.
16. Includes gas piping and shutoff (field assembly required).
17. Requires use of disconnect or circuit breaker. Reference Table 4, p. 29 table.
18. Novar is not available with SZVAV products.
19. Must be used with BACnet® open protocol.
20. Standard metering devices are TXVs.
21. Requires selection of 2" pleated filters (option B or C) for Digit 16.
22. Not available on all single phase or standard efficiency.
23. High pressure control is standard on all units.
24. Frostat™ cannot be field installed in electro-mechanical units.
25. Frostat™ standard on Y/TSC036 to 060G and T/YSC090H electromechanical, multi-speed and SZVAV (single zone variable air volume) products.
26. Not available with high temperature duct sensor accessory.
27. The return air smoke detector may not fit up or work properly on the Precedent™ units when used in conjunction with 3rd party accessories such as bolt on heat wheels, economizers and power exhaust. Do not order the return air smoke detectors when using this type of accessory.
28. Return air smoke detector cannot be ordered with Novar controls.
29. These options are standard when ordering Novar controls.
30. This option is used when ordering Novar controls.
31. Novar sensor utilized with Digit 21 = (4) Novar 3051 controls without zone sensor.
32. Demand control ventilation not available with electromechanical controls.
33. Demand control ventilation option includes wiring only. The CO<sub>2</sub> sensor is a field-installed only option.

**Table 3. Digit 15 Selection Details**

<b>Digit 15 = 0</b>
<b>Standard Efficiency</b>
3 Phase (3 to 5 Ton) = Multispeed Direct Drive Motor
3 Phase (6 to 8.5 Ton) = Belt Drive
3 Phase (10 Ton) = Ultra High Efficiency Direct Drive Plenum Fan
<b>High Efficiency</b>
3 Phase (3 to 5 ton) = High Efficiency Multispeed Direct Drive Motor
3 Phase (3 to 5 ton w/Dehumidification) = Belt Drive Motor
3 Phase [6 (074) to 10 ton] = Ultra High Efficiency Direct Drive Plenum Fan
<b>Digit 15 = 2</b>
<b>Standard Efficiency</b>
3 Phase = Not Available
<b>High Efficiency</b>
3 Phase (3 to 5 tons) = May be Ordered

# Precedent 3-10 Ton Packaged Cooling Model Number Description

---

**Table 3. Digit 15 Selection Details (continued)**

3 Phase (3 to 5 tons w/dehumidification) = Not Available
3 Phase (6 to 10 tons) = Not Available

**Table 4. Not Available in Model Number**

<b>Standard Efficiency</b>
3 to 5 Tons and 10 Ton w/575V
<b>High Efficiency</b>
3 to 5 Tons w/Standard Indoor Motor w/460V
High Efficiency 575V

ONLINE ONLY COPY

# Precedent 3-10 Ton Packaged Cooling General Data

**Table 5. General data — 3 to 5 tons — standard efficiency**

	<b>3 Tons</b>	<b>4 Tons</b>	<b>5 Tons</b>
	<b>T/YSC036G3,4,W</b>	<b>T/YSC048G3,4,W</b>	<b>T/YSC060G3,4,W</b>
<b>Cooling Performance<sup>(a)</sup></b>			
Gross Cooling Capacity	37,000	49,000	60,000
EER/SEER <sup>(b)</sup>	12.0/14.0	12.0/14.0	12.0/14.0
Nominal cfm/AHRI Rated cfm	1,200/1,200	1,600/1,600	2,000/2,000
AHRI Net Cooling Capacity	36,000	48,000	58,500
System Power (kW)	3.00	4.00	4.88
<b>Compressor</b>			
Number/Type	1/Scroll	1/Scroll	1/Scroll
<b>Sound</b>			
Outdoor Sound Rating (dB) <sup>(c)</sup>	79	80	81
<b>Outdoor Coil</b>			
Type	Microchannel	Microchannel	Microchannel
Configuration	Full Face	Full Face	Full Face
Tube Size (in.)	0.63	0.63	1.00
Face Area (sq. ft.)	10.50	10.50	11.90
Rows/FPI (Fins per inch)	1/23	1/23	1/23
<b>Indoor Coil</b>			
Type	Microchannel	Microchannel	Microchannel
Configuration	Full Face	Full Face	Full Face
Tube Size (in.)	0.63	0.63	0.81
Face Area (sq. ft.)	6.98	6.98	8.15
Rows/FPI (Fins per inch)	2/16	2/16	2/16
Refrigerant Control	Thermal Expansion Valve	Thermal Expansion Valve	Thermal Expansion Valve
Drain Connection No./Size (in.)	1¾ NPT	1¾ NPT	1¾ NPT
<b>Outdoor Fan</b>			
Type	Propeller	Propeller	Propeller
No. Used/Diameter (in.)	1/22	1/22	1/22
Drive Type/No. Speeds	Direct/1	Direct/1	Direct/1
CFM	3,600	4,050	3950
Motor HP	0.25	0.33	0.40
Motor RPM	1,100	1,100	1100
<b>Indoor Fan</b>			
Type (Standard)	FC Centrifugal	FC Centrifugal	FC Centrifugal
No. Used/Diameter (in.)/Width (in.)	1	1	1
Drive Type/No. Speeds/RPM	11x11	11x11	11x11
Number Motors	Direct/5 <sup>(d)</sup>	Direct/5 <sup>(d)</sup>	Direct/5 <sup>(d)</sup>
Motor HP	0.75/1.5	1.0/1.5	1.0/1.5
Motor Frame Size	48	48	48
<b>Filters<sup>(e)</sup></b>			
Type Furnished	Throwaway	Throwaway	Throwaway
Number Size Recommended	(2) 20x35x2	(2) 20x35x2	(2) 20x35x2
<b>Refrigerant Charge<sup>(f)</sup></b>			
lbs of R-410A	3.2	3.5	4.8
<b>Heating Performance (Gas/ Electric Only)<sup>(g)</sup></b>			
<b>Heating Input</b>			
Low Heat Input (Btu)	80,000 / 56,000	80,000 / 56,000	80,000 / 56,000
Mid Heat Input (Btu)	100,000 / 70,000	100,000 / 70,000	100,000 / 70,000
High Heat Input (Btu)	120,000 / 84,000	130,000 / 91,000	150,000 / 105,000

# Precedent 3-10 Ton Packaged Cooling General Data

**Table 5. General data – 3 to 5 tons – standard efficiency (continued)**

	<b>3 Tons</b>	<b>4 Tons</b>	<b>5 Tons</b>
	<b>T/YSC036G3,4,W</b>	<b>T/YSC048G3,4,W</b>	<b>T/YSC060G3,4,W</b>
<b>Heating Output</b>			
Low Heat Output (Btu)	64,800 / 45,300	64,800 / 45,300	64,800 / 45,300
Mid Heat Output (Btu)	81,000 / 56,700	81,000 / 56,700	81,000 / 56,700
High Heat Output (Btu)	97,200 / 68,000	105,300 / 73,700	121,500 / 85,100
<b>Steady State Efficiency %</b>			
Low Heat Input (Btu)	81	81	81
Mid Heat Input (Btu)	81	81	81
High Heat Input (Btu)	81	81	81
<b>No. Burners</b>			
Low Heat Output (Btu)	2	2	2
Mid Heat Output (Btu)	3	3	3
High Heat Output (Btu)	4	4	4
<b>No. Stages</b>			
Low Heat Input (Btu)	2	2	2
Mid Heat Input (Btu)	2	2	2
High Heat Input (Btu)	2	2	2
<b>Gas Supply Line Pressure</b>			
Natural (minimum/maximum)	4.5/14.0	4.5/14.0	4.5/14.0
LP (minimum/maximum)	11.0/14.0	11.0/14.0	11.0/14.0
<b>Gas Connection Pipe Size (in.)</b>			
Low Heat	1/2	1/2	1/2
Mid Heat	1/2	1/2	1/2
High Heat	3/4	3/4	3/4

- (a) Cooling performance is rated at 95°F ambient, 80°F entering dry bulb, 67°F entering wet bulb. Gross capacity does not include the effect of fan motor heat. AHRI capacity is net and includes the effect of fan motor heat. Units are suitable for operation to ±20% of nominal cfm. Units are certified in accordance with the Unitary Air-Conditioner Equipment certification program, which is based on AHRI Standard 210/240.
- (b) EER and/or SEER are rated at AHRI conditions and in accordance with DOE test procedures.
- (c) Outdoor sound rating shown is tested in accordance with AHRI Standard 270. For additional information reference the outdoor sound power level data in the performance section.
- (d) For multispeed direct drive rpm TSC/YSC values, reference the direct drive, evaporator fan performance data.
- (e) Optional 2" MERV 8 and MERV 13 filters also available.
- (f) Refrigerant charge is an approximate value. For a more precise value, see unit nameplate and service instructions.
- (g) Heating performance limit settings and rating data were established and approved under laboratory test conditions using American National Standards Institute standards. Ratings shown are for elevations up to 2000 feet. For elevations above 2000 feet, ratings should be reduced at the rate of 4% for each 1000 feet above sea level. Applicable to gas/electric units only.

# Precedent 3-10 Ton Packaged Cooling General Data

**Table 6. General data — 6 to 10 tons — standard efficiency**

	<b>6 Tons</b>	<b>7.5 Tons</b>	<b>7.5 Tons</b>	<b>8.5 Tons</b>	<b>10 Tons</b>
	<b>T/YSC 072H3,4,W</b>	<b>Single Compressor T/YSC 090H3,4,W</b>	<b>Dual Compressor T/YSC 092H3,4,W</b>	<b>T/YSC 102H3,4,W</b>	<b>T/YSC 120H3,4,W</b>
<b>Cooling Performance<sup>(a)</sup></b>					
Gross Cooling Capacity	75,000	92,500	94,800	107,200	116,000
EER <sup>(b)</sup>	11.2	11.2	11.2	11.2	11.2
Nominal cfm/AHRI Rated cfm	2,400/2,100	3,000/2,400	3,000/2,325	3,400/2,720	4,000/4,000
AHRI Net Cooling Capacity	71,000	87,000	90,000	102,000	113,000
IEER (T/Y) <sup>(c)</sup>	12.9 / 12.7	12.9 / 12.7	12.9/12.7 <sup>(d)</sup>	12.9 / 12.7 <sup>(e)</sup>	12.9/12.7
System Power (kW)	6.36	7.77	8.04	9.11	10.09
<b>Compressor</b>					
Number/Type	1/Scroll	1/Scroll	2/Scroll	2/Scroll	2/Scroll
<b>Sound</b>					
Outdoor Sound Rating (dB) <sup>(f)</sup>	89	89	91	88	88
<b>Outdoor Coil</b>					
Type	Microchannel	Microchannel	Microchannel	Microchannel	Microchannel
Configuration	Full Face	Full Face	Face-split	Face-Split	Face Split
Tube Size (in.)	0.71	1.00	0.71	1	1
Face Area (sq. ft.)	16.91	16.91	17.31	20.77	20.77
Rows/FPI (Fins per inch)	1/23	1/21	1/23	1/21	1/20
<b>Indoor Coil</b>					
Type	Lanced	Lanced	Lanced	Lanced	Lanced
Configuration	Full Face	Full Face	Face-split	Intertwined	Intertwined
Tube Size (in.)	0.3125	0.3125	0.3125	0.3125	0.3125
Face Area (sq. ft.)	9.89	9.89	12.36	12.36	12.36
Rows/FPI (Fins per inch)	3/16	4/16	3/16	4/16	4/16
Refrigerant Control	Thermal Expansion Valve	Thermal Expansion Valve	Thermal Expansion Valve	Thermal Expansion Valve	Thermal Expansion Valve
Drain Connection No./Size (in.)	1¾ NPT	1¾ NPT	1¾ NPT	1¾ NPT	1¾ NPT
<b>Outdoor Fan</b>					
Type	Propeller	Propeller	Propeller	Propeller	Propeller
No. Used/Diameter (in.)	1/26	1/26	1/26	1/26	1/26
Drive Type/No. Speeds	Direct/1	Direct/1	Direct/1	Direct/1	Direct/1
CFM	6,037	6400	6600	6680	6800
Motor HP	0.70	0.70	0.70	0.70	0.70
Motor RPM	1,100	1,100	1,100	1,100	1,100
<b>Indoor Fan</b>					
Type	FC Centrifugal	FC Centrifugal	FC Centrifugal <sup>(g)</sup>	FC Centrifugal <sup>(g)</sup>	BC Plenum
No. Used/Diameter (in.)/Width (in.)	1/12x12	1/12x12	1/15x15 <sup>(h)</sup>	1/15x15 <sup>(h)</sup>	1/23.0315x6.14
Drive Type/No. Speeds/RPM	Belt/Variable/1,750	Belt/Variable/1,750	Belt/Variable/1,750 <sup>(i)</sup>	Belt/Variable/1,750 <sup>(i)</sup>	Direct/Variable <sup>(f)</sup>
Motor HP (Standard/Oversized)	1.0/2.0	1.0/3.0	1.0/3.0 <sup>(i)</sup>	2.0/3.0 <sup>(i)</sup>	2.75/—
Motor Frame Size (Standard/Oversized)	56/56	56/56	56/56	56/56	—/—
<b>Filters<sup>(k)</sup></b>					
Type Furnished	Throwaway	Throwaway	Throwaway	Throwaway	Throwaway
Number Size Recommended	(4) 16x25x2	(4) 16x25x2	(4) 20x25x2	(4) 20x25x2	(4) 20x25x2
<b>Refrigerant Charge<sup>(l)</sup></b>					
lbs of R-410A	5.5	7.5	3.8/3.6	6.2/3.9	5.6/4.4
<b>Heating Performance (Gas/ Electric Only)<sup>(m)</sup></b>					
<b>Heating Input</b>					
Low Heat Input (Btu)	80,000	120,000	120,000	120,000	150,000/105,000
Mid Heat Input (Btu)	120,000	150,000/105,000	150,000/105,000	150,000/105,000	200,000/140,000
High Heat Input (Btu)	150,000/105,000	200,000/140,000	200,000/140,000	200,000/140,000	235,000/164,500

For complete equipment / combination selections, installation instructions and warranty information, please refer to Product Data/Ratings and/or Installers Guides and Limited Warranty Handbooks.

# Precedent 3-10 Ton Packaged Cooling General Data

**Table 6. General data – 6 to 10 tons – standard efficiency (continued)**

	<b>6 Tons</b>	<b>7.5 Tons</b>	<b>7.5 Tons</b>	<b>8.5 Tons</b>	<b>10 Tons</b>
	<b>T/YSC 072H3,4,W</b>	<b>Single Compressor T/YSC 090H3,4,W</b>	<b>Dual Compressor T/YSC 092H3,4,W</b>	<b>T/YSC 102H3,4,W</b>	<b>T/YSC 120H3,4,W</b>
<b>Heating Output</b>					
Low Heat Output (Btu)	64,000	96,000	96,000 <sup>(n)</sup>	96,000 <sup>(n)</sup>	120,000/84,000
Mid Heat Output (Btu)	96,000	120,000/84,000	120,000/84,000 <sup>(n)</sup>	120,000/84,000 <sup>(n)</sup>	160,000/112,000
High Heat Output (Btu)	120,000/84,000	160,000/112,000	160,000/112,000 <sup>(n)</sup>	160,000/112,000 <sup>(n)</sup>	188,000/131,600
<b>Steady State Efficiency %</b>					
Low Heat Input (Btu)	80	80	80 <sup>(o)</sup>	80 <sup>(o)</sup>	80
Mid Heat Input (Btu)	80	80	80 <sup>(o)</sup>	80 <sup>(o)</sup>	80
High Heat Input (Btu)	80	80	80 <sup>(o)</sup>	80 <sup>(o)</sup>	80
<b>No. Burners</b>					
Low Heat Output (Btu)	2	3	3	3	3
Mid Heat Output (Btu)	3	3	3	3	4
High Heat Output (Btu)	3	4	4 <sup>(p)</sup>	4 <sup>(p)</sup>	5
<b>No. Stages</b>					
Low Heat Input (Btu)	1	1	1	1	2
Mid Heat Input (Btu)	1	2	2	2	2
High Heat Input (Btu)	2	2	2	2	2
<b>Gas Supply Line Pressure</b>					
Natural (minimum/maximum)	4.5/14.0	4.5/14.0	4.5/14.0	4.5/14.0	4.5/14.0
LP (minimum/maximum)	11.0/14.0	11.0/14.0	11.0/14.0	11.0/14.0	11.0/14.0
<b>Gas Connection Pipe Size (in.)</b>					
Low Heat	1/2	1/2	1/2	1/2	3/4
Mid Heat	1/2	3/4	3/4	3/4	3/4
High Heat	3/4	3/4	3/4	3/4	3/4

- (a) Cooling performance is rated at 95°F ambient, 80°F entering dry bulb, 67°F entering wet bulb. Gross capacity does not include the effect of fan motor heat. AHRI capacity is net and includes the effect of fan motor heat. Units are suitable for operation to ±20% of nominal cfm. Units are certified in accordance with the Unitary Air-Conditioner Equipment certification program, which is based on AHRI Standard 340/360.
- (b) EER is rated at AHRI conditions and in accordance with DOE test procedures.
- (c) Integrated Efficiency Ratio (IEER) is rated in accordance with AHRI Standard 340/360. The IEER rating requires that the unit efficiency be determined at 100%, 75%, 50% and 25% load (net capacity) at the specified in AHRI Standard.
- (d) 13.7 IEER for SZVAV option, 13.4 IEER for Title24 2 speed fan option.
- (e) 13.7 IEER for SZVAV option, 13.4 IEER for Title24 2 speed fan option
- (f) Outdoor sound rating shown is tested in accordance with AHRI Standard 270. For additional information reference the outdoor sound power level data in the performance section.
- (g) For SZVAV / Title 24 Option, Backward Airfoil Plenum
- (h) For SZVAV / Title 24 Option, 1/23.03
- (i) For SZVAV / Title 24 Option, Plenum/Variable/1,700
- (j) For SZVAV / Title 24 Option, 2.75
- (k) Optional 2" MERV 8 and MERV 13 filters also available.
- (l) Refrigerant charge is an approximate value. For a more precise value, see unit nameplate and service instructions.
- (m) Heating performance limit settings and rating data were established and approved under laboratory test conditions using American National Standards Institute standards. Ratings shown are for elevations up to 2000 feet. For elevations above 2000 feet, ratings should be reduced at the rate of 4% for each 1000 feet above sea level. Applicable to gas/electric units only.
- (n) For SZVAV / Title24 Option, Low = 97,200, Mid = 121,500, High = 162,000
- (o) For SZVAV / Title24 Option, Steady State Efficiency = 81%
- (p) 5 burners for SZVAV / Title24 Option

# Precedent 3-10 Ton Packaged Cooling General Data

**Table 7. General data – 3 to 5 tons – high efficiency**

	<b>3 Tons T/YHC 036E3,4,W</b>	<b>4 Tons T/YHC 048E3,4,W</b>	<b>4 Tons T/YHC 048F3,4,W</b>	<b>5 Tons T/YHC 060E3,4,W</b>	<b>5 Tons T/YHC 060F3,4,W</b>
<b>Cooling Performance<sup>(a)</sup></b>					
Gross Cooling Capacity	37,600	49,930	49,930	61,000	61,000
EER/SEER <sup>(b)</sup>	E3,4= 12.7/15.0 EW=12.0/14.4"	14.2	13.2/15.0	14.2	12.85/15.0
Nominal cfm/AHRI Rated cfm	1,200/1,200	1,600/1,600	1,600/1,600	2,000/2,000	2,000/2,000
AHRI Net Cooling Capacity	37,000	49,000	49,000	60,000	60,000
System Power (kW)	2.99	3.67	3.67	4.67	4.67
<b>Compressor</b>					
Number/Type	1/Scroll	1/Scroll	1/Scroll	1/Scroll	1/Scroll
<b>Sound</b>					
Outdoor Sound Rating (dB) <sup>(c)</sup>	81	87	87	87	87
<b>Outdoor Coil</b>					
Type	Lanced	Lanced	Microchannel	Lanced	Microchannel
Configuration	Full Face	Full Face	Full Face	Full Face	Full Face
Tube Size (in.)	0.3125	0.3125	0.71	0.3125	0.71
Face Area (sq. ft.)	10.96	17.00	16.91	17	16.91
Rows/FPI (Fins per inch)	2/16	3/16	1/23	3/16	1/23
<b>Indoor Coil</b>					
Type	Lanced	Lanced	Lanced	Lanced	Lanced
Configuration	Full Face	Full Face	Full Face	Full Face	Full Face
Tube Size (in.)	0.3125	0.3125	0.3125	0.3125	0.3125
Face Area (sq. ft.)	7.71	9.27	9.27	9.89	9.89
Rows/FPI (Fins per inch)	3/16	3/16	3/16	4/16	4/16
Refrigerant Control	Thermal Expansion Valve	Thermal Expansion Valve	Thermal Expansion Valve	Thermal Expansion Valve	Thermal Expansion Valve
Drain Connection No./Size (in.)	1¾ NPT	1¾ NPT	1¾ NPT	1¾ NPT	1¾ NPT
<b>Outdoor Fan</b>					
Type	Propeller	Propeller	Propeller	Propeller	Propeller
No. Used/Diameter (in.)	1/22	1/26	1/26	1/26	1/26
Drive Type/No. Speeds	Direct/1	Direct/1	Direct/1	Direct/1	Direct/1
CFM	3,064	3,982	3,982	3,953	3,953
Motor HP	0.20	0.40	0.40	0.40	0.40
Motor RPM	1,075	1,075	1,075	1,075	1,075
<b>Indoor Fan</b>					
Type (Standard) <sup>(d)</sup>	FC Centrifugal	FC Centrifugal	FC Centrifugal	FC Centrifugal	FC Centrifugal
No. Used/Diameter (in.)/Width (in.)	1/11x11	1/11x11	1/11x11	1/11x11	1/11x11
Drive Type/No. Speeds/RPM <sup>(e)</sup>	Direct/5	Direct/5	Direct/5	Direct/5	Direct/5
Number Motors	1	1	1	□	□
Motor HP	0.75	1.0	1.0	1.0	1.0
Motor Frame Size	48	48	48	48	48
<b>Indoor Fan</b>					
Type (Optional)	FC Centrifugal	FC Centrifugal	FC Centrifugal	FC Centrifugal	FC Centrifugal
No. Used/Diameter (in.)/Width (in.)	1/11x11	1/11x11	1/11x11	1/11x11	1/11x11
Drive Type/No. Speeds/RPM	Belt/Variable	Belt/Variable	Belt/Variable	Belt/Variable	Belt/Variable
Number Motors	1	1	1	□	□
Motor HP	1.0	1.0	1.0	1.0	1.0
Motor Frame Size	56	56	56	56	56
<b>Filters<sup>(f)</sup></b>					
Type Furnished	Throwaway	Throwaway	Throwaway	Throwaway	Throwaway
Number Size Recommended	(2) 20x30x2	(4) 16x25x2	(4) 16x25x2	(4) 16x25x2	(4) 16x25x2
<b>Optional Hot Gas Reheat Coil</b>					
Tube Size (in.) OD	0.3125	0.3125	—	0.3125	—

For complete equipment / combination selections, installation instructions and warranty information, please refer to Product Data/Ratings and/or Installers Guides and Limited Warranty Handbooks.



# Precedent 3-10 Ton Packaged Cooling General Data

**Table 7. General data — 3 to 5 tons — high efficiency (continued)**

	<b>3 Tons T/YHC 036E3,4,W</b>	<b>4 Tons T/YHC 048E3,4,W</b>	<b>4 Tons T/YHC 048F3,4,W</b>	<b>5 Tons T/YHC 060E3,4,W</b>	<b>5 Tons T/YHC 060F3,4,W</b>
Face Area (sq. ft.)	5.23	6.28	—	6.28	—
Rows/FPI (Fins per inch)	1/16	1/16	—	1/16	—
<b>Refrigerant Charge (lbs. of R-410A)<sup>(g)</sup></b>					
Standard	6.2	—	5.2	—	6.1
Optional Hot Gas Reheat Coil	10.5	15.2	—	15.7	—
<b>Heating Performance (Gas/ Electric Only)<sup>(h)</sup></b>					
<b>Heating Input</b>					
Low Heat Input (Btu)	60,000	60,000	60,000	60,000	60,000
Mid Heat Input (Btu)	80,000	80,000	80,000	80,000	80,000
High Heat Input (Btu)	120,000	120,000	120,000	130,000	130,000
<b>Heating Output</b>					
Low Heat Output (Btu)	48,000	49,000	49,000	49,000	49,000
Mid Heat Output (Btu)	64,000	64,000	64,000	64,000	64,000
High Heat Output (Btu)	96,000	96,000	96,000	104,000	104,000
<b>AFUE %</b>					
Low Heat Input (Btu)	78	80	80	80	80
Mid Heat Input (Btu)	78	79	79	79	79
High Heat Input (Btu)	78	79	79	80	80
<b>Steady State Efficiency %</b>					
Low Heat Input (Btu)	80	81	81	81	81
Mid Heat Input (Btu)	80	80	80	80	80
High Heat Input (Btu)	80	81	81	80	80
<b>No. Burners</b>					
Low Heat Output (Btu)	2	2	2	2	2
Mid Heat Output (Btu)	2	2	2	2	2
High Heat Output (Btu)	3	3	3	3	3
<b>No. Stages</b>					
Low Heat Input (Btu)	1	1	1	1	1
Mid Heat Input (Btu)	1	1	1	1	1
High Heat Input (Btu)	1	1	1	1	1
<b>Gas Supply Line Pressure</b>					
Natural (minimum/maximum)	4.5/14.0	4.5/14.0	4.5/14.0	4.5/14.0	4.5/14.0
LP (minimum/maximum)	11.0/14.0	11.0/14.0	11.0/14.0	11.0/14.0	11.0/14.0
<b>Gas Connection Pipe Size (in.)</b>					
Low Heat	1/2	1/2	1/2	1/2	1/2
Mid Heat	1/2	1/2	1/2	1/2	1/2
High Heat	1/2	1/2	1/2	1/2	1/2

**Note:** 575V (W voltage) is only available as YHC. No THC models available with 575V (W voltage).

- (a) Cooling performance is rated at 95°F ambient, 80°F entering dry bulb, 67°F entering wet bulb. Gross capacity does not include the effect of fan motor heat. AHRI capacity is net and includes the effect of fan motor heat. Units are suitable for operation to ±20% of nominal cfm. Units are certified in accordance with the Unitary Air-Conditioner Equipment certification program, which is based on AHRI Standard 210/240.
- (b) EER and/or SEER are rated at AHRI conditions and in accordance with DOE test procedures.
- (c) Outdoor sound rating shown is tested in accordance with AHRI Standard 270. For additional information reference the outdoor sound power level data in the performance section.
- (d) Belt drive fan is standard on units with reheat option.
- (e) For multispeed direct drive rpm THC/YHC values, reference the direct drive, evaporator fan performance data.
- (f) Optional 2" MERV 8 and MERV 13 filters also available.
- (g) Refrigerant charge is an approximate value. For a more precise value, see unit nameplate and service instructions.

# Precedent 3-10 Ton Packaged Cooling General Data

**Table 8. General data – 6 to 7.5 tons – high efficiency**

	<b>6 Tons Single Compressor T/YHC072E/F3,4,W</b>	<b>6 Tons Dual Compressor T/YHC074F3,4</b>	<b>7.5 Tons T/YHC092F3,4,W</b>
<b>Cooling Performance<sup>(a)</sup></b>			
Gross Cooling Capacity	72,000	73,000	92,000
EER <sup>(b)</sup>	12.6	13.1	12.6
Nominal cfm/AHRI Rated cfm	2,400/2,100	2,400/2,100	3,000/2,625
AHRI Net Cooling Capacity	68,000	71,000	89,000
IEER <sup>(c)</sup>	14.5	15.5 <sup>(d)</sup>	14.5 <sup>(e)</sup>
System Power (kW)	5.37	5.42	7.06
<b>Compressor</b>			
Number/Type	1/Scroll	2/Scroll	2/Scroll
<b>Sound</b>			
Outdoor Sound Rating (dB) <sup>(f)</sup>	89	89	88
<b>Outdoor Coil</b>			
Type	Microchannel	Microchannel	Microchannel
Configuration	Full Face	Face-Split	Face-Split
Tube Size (in.)	0.71	1	1
Face Area (sq. ft.)	20.77	20.77	20.77
Rows/FPI (Fins per inch)	1/23	1/20	1/20
<b>Indoor Coil</b>			
Type	Lanced	Lanced	Lanced
Configuration	Full Face	Intertwined	Intertwined
Tube Size (in.)	0.3125	0.3125	0.3125
Face Area (sq. ft.)	12.36	12.36	12.36
Rows/FPI (Fins per inch)	4/16	4/16	4/16
Refrigerant Control	Thermal Expansion Valve	Thermal Expansion Valve	Thermal Expansion Valve
Drain Connection No./Size (in.)	1¼ NPT	1¼ NPT	1¼ NPT
<b>Outdoor Fan</b>			
Type	Propeller	Propeller	Propeller
No. Used/Diameter (in.)	1/26	1/26	1/26
Drive Type/No. Speeds	Direct/1	Direct/1	Direct/1
CFM	5900	5750	6800
Motor HP	0.7	0.7	0.75
Motor RPM	1100	1100	1100
<b>Indoor Fan</b>			
Type	FC Centrifugal	BC Plenum	BC Plenum
No. Used/Diameter (in.)/Width (in.)	1/15x15	1/23.0315x6.14	1/23.0315x6.14
Drive Type/No. Speeds <sup>(g)</sup> /RPM	Belt/Variable/1,750	Direct/Variable	Direct/Variable
Motor HP (Standard/Oversized)	1.0/2.0	2.75/—	2.75/—
Motor Frame Size (Standard/Oversized)	56/56	—/—	—/—
<b>Filters<sup>(h)</sup></b>			
Type Furnished	Throwaway	Throwaway	Throwaway
Number Size Recommended	(4) 20x25x2	(4) 20x25x2	(4) 20x25x2
<b>Optional Hot Gas Reheat Coil</b>			
Tube Size (in.) OD	—	—	0.3125
Face Area (sq. ft.)	—	—	8.652
Rows/FPI (Fins per inch)	—	—	1/16
<b>Refrigerant Charge<sup>(i)</sup></b>			
Standard	7.7	5.8/4.1	5.5/4.2
Optional Hot Gas Reheat Coil	—	—	6.2/4.3
<b>Heating Performance (Gas/ Electric Only)<sup>(j)</sup></b>			
<b>Heating Input</b>			

For complete equipment / combination selections, installation instructions and warranty information, please refer to Product Data/Ratings and/or Installers Guides and Limited Warranty Handbooks.

# Precedent 3-10 Ton Packaged Cooling General Data

**Table 8. General data — 6 to 7.5 tons — high efficiency (continued)**

	<b>6 Tons Single Compressor T/YHC072E/F3,4,W</b>	<b>6 Tons Dual Compressor T/YHC074F3,4</b>	<b>7.5 Tons T/YHC092F3,4,W</b>
Low Heat Input (Btu)	80,000	80,000	120,000
Mid Heat Input (Btu)	120,000	120,000	150,000/105,000
High Heat Input (Btu)	150,000/105,000	150,000/105,000	200,000/140,000
<b>Heating Output</b>			
Low Heat Output (Btu)	64,000	64,800	96,000
Mid Heat Output (Btu)	96,000	97,200	120,000/84,000
High Heat Output (Btu)	120,000/84,000	121,500/85,050	160,000/112,000
<b>Steady State Efficiency %</b>			
Low Heat Input (Btu)	80	81	80
Mid Heat Input (Btu)	80	81	80
High Heat Input (Btu)	80	81	80
<b>No. Burners</b>			
Low Heat Output (Btu)	3	3	3
Mid Heat Output (Btu)	3	3	3
High Heat Output (Btu)	4	4	4
<b>No. Stages</b>			
Low Heat Input (Btu)	1	1	1
Mid Heat Input (Btu)	1	1	2
High Heat Input (Btu)	2	2	2
<b>Gas Supply Line Pressure</b>			
Natural (minimum/maximum)	4.5/14.0	4.5/14.0	4.5/14.0
LP (minimum/maximum)	11.0/14.0	11.0/14.0	11.0/14.0
<b>Gas Connection Pipe Size (in.)</b>			
Low Heat	1/2	1/2	1/2
Mid Heat	1/2	1/2	3/4
High Heat	3/4	3/4	3/4

**Note:** 575V (W voltage) is only available as YHC. No THC models available with 575V (W voltage).

- (a) Cooling performance is rated at 95°F ambient, 80°F entering dry bulb, 67°F entering wet bulb. Gross capacity does not include the effect of fan motor heat. AHRI capacity is net and includes the effect of fan motor heat. Units are suitable for operation to ±20% of nominal cfm. Units are certified in accordance with the Unitary Air-Conditioner Equipment certification program, which is based on AHRI Standard 340/360.
- (b) EER is rated at AHRI conditions and in accordance with DOE test procedures.
- (c) Integrated Efficiency Ratio (IEER) is rated in accordance with AHRI Standard 340/360. The IEER rating requires that the unit efficiency be determined at 100%, 75%, 50% and 25% load (net capacity) at the specified in AHRI Standard.
- (d) 16.0 IEER for multi-speed, SZVAV, and MZVAV.
- (e) 15.0 IEER for multi-speed, SZVAV, and MZVAV 208-230/460V.
- (f) Outdoor sound rating shown is tested in accordance with AHRI Standard 270. For additional information reference the outdoor sound power level data in the performance section.
- (g) For multispeed direct drive rpm T/YHC values, reference the direct drive, evaporator fan performance data. This note only applicable to T/YHC074F3,4,W and T/YHC092F3,4,W.
- (h) Optional 2" MERV 8 and MERV 13 filters also available.
- (i) Refrigerant charge is an approximate value. For a more precise value, see unit nameplate and service instructions.
- (j) Heating performance limit settings and rating data were established and approved under laboratory test conditions using American National Standards Institute standards. Ratings shown are for elevations up to 2000 feet. For elevations above 2000 feet, ratings should be reduced at the rate of 4% for each 1000 feet above sea level. Applicable to gas/electric units only.

# Precedent 3-10 Ton Packaged Cooling General Data

**Table 9. General data — 8.5 to 10 tons — high efficiency**

	<b>8.5 Tons</b>	<b>10 Tons</b>
	<b>T/YHC102F3,4,W</b>	<b>T/YHC120F3,4,W</b>
<b>Cooling Performance<sup>(a)</sup></b>		
Gross Cooling Capacity	104,000	116,000
EER <sup>(b)</sup>	T=12.5 Y=12.4	12.4
Nominal cfm/AHRI Rated cfm	3,400/2,720	4,000/3,800
AHRI Net Cooling Capacity	99,000	113,000
IEER <sup>(c)</sup>	T=14.7 <sup>(d)</sup> YHC102FW=14.5	IEER = 14.7 SZVAV, IEER = 15.2
System Power (kW)	7.92	9.11
<b>Compressor</b>		
Number/Type	2/Scroll	2/Scroll
<b>Sound</b>		
Outdoor Sound Rating (dB) <sup>(e)</sup>	89	87
<b>Outdoor Coil</b>		
Type	Microchannel	Microchannel
Configuration	Face Split	Face Split
Tube Size (in.)	1	1
Face Area (sq. ft.)	20.77	26.77
Rows/FPI (Fins per inch)	1/20	1/23
<b>Indoor Coil</b>		
Type	Lanced	Lanced
Configuration	Intertwined	Intertwined
Tube Size (in.)	0.3125	0.3125
Face Area (sq. ft.)	12.36	16.65
Rows/FPI (Fins per inch)	5/16	4/16
Refrigerant Control	Thermal Expansion Valve	Thermal Expansion Valve
Drain Connection No./Size (in.)	1¾ NPT	1¾ NPT
<b>Outdoor Fan</b>		
Type	Propeller	Propeller
No. Used/Diameter (in.)	1/26	1/30
Drive Type/No. Speeds	Direct/1	Direct/1
CFM	6,800	7,540
Motor HP	0.75	0.75
Motor RPM	1,100	1,100
<b>Indoor Fan</b>		
Type (Standard)	BC Plenum	BC Plenum
No. Used/Diameter (in.)/Width (in.)	1/23.0315x6.14	1/23.0315x6.14
Drive Type/No. Speeds/RPM <sup>(f)</sup>	Direct/Variable	Direct/Variable
Motor HP	2.75/—	2.75/—
Motor Frame Size	—/—	—/—
<b>Filters<sup>(g)</sup></b>		
Type Furnished	Throwaway	Throwaway
Number Size Recommended	(4) 20x25x2	(3) 20x25x2 (2) 20x30x2
<b>Optional Hot Gas Reheat Coil</b>		
Tube Size (in.) OD	0.3125	0.3125
Face Area (sq. ft.)	8.652	15.23
Rows/FPI (Fins per inch)	1/16	1/16
<b>Refrigerant Charge (lbs. of R-410A)<sup>(h)</sup></b>		
Standard	6.3/4.9	7.7/5.2
Optional Hot Gas Reheat Coil	6.6/4.7	8.6/5.2
<b>Heating Performance (Gas/Electric Only)<sup>(i)</sup></b>		

# Precedent 3-10 Ton Packaged Cooling General Data

**Table 9. General data – 8.5 to 10 tons – high efficiency (continued)**

	<b>8.5 Tons</b>	<b>10 Tons</b>
	<b>T/YHC102F3,4,W</b>	<b>T/YHC120F3,4,W</b>
<b>Heating Input</b>		
Low Heat Input (Btu)	120,000	150,000/105,000
Mid Heat Input (Btu)	150,000/105,000	200,000/140,000
High Heat Input (Btu)	200,000/140,000	250,000/175,000
<b>Heating Output</b>		
Low Heat Output (Btu)	96,000	120,000/84,000
Mid Heat Output (Btu)	120,000/84,000	160,000/112,000
High Heat Output (Btu)	160,000/112,000	200,000/140,000
<b>Steady State Efficiency %</b>		
Low Heat Input (Btu)	80	80
Mid Heat Input (Btu)	80	80
High Heat Input (Btu)	80	80
<b>No. Burners</b>		
Low Heat Output (Btu)	3	3
Mid Heat Output (Btu)	3	4
High Heat Output (Btu)	4	5
<b>No. Stages</b>		
Low Heat Input (Btu)	1	2
Mid Heat Input (Btu)	2	2
High Heat Input (Btu)	2	2
<b>Gas Supply Line Pressure</b>		
Natural (minimum/maximum)	4.5/14.0	4.5/14.0
LP (minimum/maximum)	11.0/14.0	11.0/14.0
<b>Gas Connection Pipe Size (in.)</b>		
Low Heat	1/2	3/4
Mid Heat	3/4	3/4
High Heat	3/4	3/4

**Note:** 575V (W voltage) is only available as YHC. No THC models available with 575V (W voltage).

- (a) Cooling performance is rated at 95°F ambient, 80°F entering dry bulb, 67°F entering wet bulb. Gross capacity does not include the effect of fan motor heat. AHRI capacity is net and includes the effect of fan motor heat. Units are suitable for operation to ±20% of nominal cfm. Units are certified in accordance with the Unitary Air-Conditioner Equipment certification program, which is based on AHRI Standard 340/360.
- (b) EER is rated at AHRI conditions and in accordance with DOE test procedures.
- (c) Integrated Efficiency Ratio (IEER) is rated in accordance with AHRI Standard 340/360. The IEER rating requires that the unit efficiency be determined at 100%, 75%, 50% and 25% load (net capacity) at the specified in AHRI Standard.
- (d) 15.5 IEER for SZVAV
- (e) Outdoor sound rating shown is tested in accordance with AHRI Standard 270. For additional information reference the outdoor sound power level data in the performance section.
- (f) For multispeed direct drive rpm THC/YHC values, reference the direct drive, evaporator fan performance data.
- (g) Optional 2" MERV 8 and MERV 13 filters also available.
- (h) Refrigerant charge is an approximate value. For a more precise value, see unit nameplate and service instructions.
- (i) Heating performance limit settings and rating data were established and approved under laboratory test conditions using American National Standards Institute standards. Ratings shown are for elevations up to 2000 feet. For elevations above 2000 feet, ratings should be reduced at the rate of 4% for each 1000 feet above sea level. Applicable to gas/electric units only.

# Precedent 3-5 Ton Packaged Cooling Selection Procedure

## Cooling Capacity

**Note:** Cooling Capacity Procedure is the same for electric heat (T°C) and gas heat (Y°C).

- Calculate the building's total and sensible cooling loads at design conditions. Use the American Standard calculation methods or any other standard accepted method.  
 Factors used in unit selection:
  - Packaged Cooling with Optional Electric Heat
  - Total Cooling Load: 58 MBh
  - Sensible Cooling Load: 40 MBh
  - Airflow: 2000 cfm
  - Electrical Characteristics: 460/60/3
  - Summer Design Conditions: Entering Evaporator Coil: 80 DB
  - 67 WB Outdoor Ambient: 95
  - External Static Pressure: 0.36 in. wg
  - Downflow Configuration
  - Efficiency: 17 SEER
  - Economizer
- As a starting point, a rough determination must be made of the size of the unit. The final selection will be made after examining the performance at the given conditions. Divide the total cooling load by nominal Btuh per ton (12 MBh per ton); then round up to the nearest unit size.  
 59 MBh / 12 MBh = approx. 5 tons
- Table 7, p. 35 shows that a THC067E4 has a **gross** cooling capacity of 60.0 MBh and 45.29 MBh sensible capacity at 2000 cfm and 95 DB outdoor ambient with 80 DB, 67 WB air entering the evaporator.

**To Find Capacity at Intermediate Conditions not in the table**

When the design conditions are between two numbers that are in the capacity table, interpolation is required to approximate the capacity.

**Note:** Extrapolation outside of the table conditions is not recommended.

- In order to select the correct unit which meets the building's requirements, the fan motor heat must be deducted from the gross cooling capacity. The amount of heat that the fan motor generates is dependent on the effort by the motor - cfm and static pressure. To determine the total unit static pressure:

External Static Duct System	0.36 wg
Standard Filter 2 in. from Table 17, p. 44	0.05 wg
Economizer from Table 17, p. 44 (100% Outside Air) *worst case	0.11 wg
Electric Heater Size 6 kW from Table 17, p. 44	0.02 wg
<b>Total Static Pressure</b>	<b>0.54 wg</b>

**Note:** (reference "Heating Capacity" on page 22 for determination of heater size)

# Precedent 3-5 Ton Packaged Cooling Selection Procedure

**Note:** The evaporator fan performance Table 13, p. 42 has deducted the pressure drop for a filter already in the unit (see note below Table 13, p. 42). Therefore, the actual total static pressure is 0.54 - 0.5 (from Table 17, p. 44) = 0.49 wg.

With 2000 cfm and 0.5 wg.  
Table 13, p. 42 shows 0.55 bhp for this unit.

**Note:** Below the table is the formula to calculate Fan Motor Heat

$$2.9245 \times \text{bhp} + 0.055 = \text{MBh.}$$
$$2.9245 \times 0.55 + 0.055 = 1.7 \text{ MBh.}$$

Now subtract the fan motor heat from the gross cooling capacity of the unit:

$$\text{Net Total Cooling Capacity} \\ = 60.0 \text{ MBh} - 1.7 = 58.3 \text{ MBh}$$

$$\text{Net Sensible Cooling Capacity} \\ = 45.3 \text{ MBh} - 1.7 = 43.6 \text{ MBh}$$

Subtracting Sensible from Total Capacity to find Latent Capacity

$$\text{Net Latent Capacity} \\ = 58.3 - 43.6 = 14.7 \text{ MBh}$$

5. Compare your resulting capacities to the building load. If the performance will not meet the required load of the building's total or sensible cooling load, try a selection at the next higher size unit.

## Heating Capacity

**Note:** Heating capacity procedure DIFFERS for electric heat (THC) and gas heat (YHC) units

1. Calculate the building heating load using the American Standard calculation form or other standard accepted method.
2. Size the system heating capacity to match the calculated building heating load. The following are building heating requirements:

Total heating load of 15 MBh

2000 cfm

THC units with optional electric heat: 460V/3 phase Power Supply

The electric heat accessory capacities are listed in Table 19, p. 45. From the table, a 6 kW heater will deliver 20.48 MBh at 480 volts. In order to determine capacity at 460 volts, the heater voltage correction factor from Table 20, p. 45 must be used. Therefore, 20.48 MBh x 0.918 (voltage correction factor) = 18.8 MBh

YHC units with gas heat: Fuel- natural gas.

60 MBh, 80 MBh and 130 MBh input models shown in Table 17, p. 44. The output capacities of these furnaces are 48 MBh, 64 MBh and 104 MBh respectively. The low heat model with 48 MBh best matches the building requirements.

## Air Delivery Selection

**Note:** Air delivery procedure is the same for electric heat and gas heat units.)

External static pressure drop through the air distribution system has been calculated to be 0.5 inches of water. Enter Table 12, p. 41 for a THC067E4 at 2000 cfm and 0.5 static pressure. The standard direct drive motor will give the desired airflow at a rated bhp of 0.55 and 835 rpm.

# Precedent 3-5 Ton Packaged Cooling Selection Procedure

## Dehumidification Selection

Dehumidification selection procedure is the same for both electric heat (THC) and gas heat (YHC models).

Typical 5 ton THC067E	OA Conditions	RA conditions
2000 cfm Total Supply airflow	Part load day and raining	75°F db
800 cfm Outside Air (40%)	68°F db	63°F wb
1200 cfm Return Air	67°F wb	
0.34 inch External Static Pressure	95% RH	

1. Determine the mixed/entering air condition (MA).

MA = (% outside air\*outside air dry-bulb temperature) + (% return air\*return air dry-bulb temperature)

$$MA = (0.40*68°F) + (0.60*75°F)$$

$$MA = 72.20°F \text{ db}$$

Repeat for wet-bulb temperature (wb).

$$MA \text{ } 72.2°F \text{ db}$$

$$64.6°F \text{ wb}$$

2. Determine the additional static pressure drop for a reheat unit.

Table 17, p. 44 shows a static pressure drop of 0.13 inch for the reheat coil and an additional 0.08 for the mandatory 2 inch pleated filters required when ordering the dehumidification option.

$$\text{Total static pressure} = \\ 0.34 + 0.08 + 0.13 = 0.55$$

**Note:** Do not forget to also add any additional static from other accessories. This selection does not include additional accessories.

3. Determine leaving evaporator temperature (SA').

$$\text{Leaving Evaporator Temperature} = SA'$$

Utilizing the manual **Cooling Capacity** selection method as previously described, find the leaving evaporator temperatures with the formula:

$$\Delta \text{ Temp} = \frac{\text{gross sensible or gross latent cooling capacity in Btuh}}{(\text{cfm}) (1.085)}$$

Subtract your sensible  $\Delta$  temp from the entering db and latent  $\Delta$  temp from the entering wb to determine the leaving evaporator db and wb (temperatures without the addition of fan heat).

$$52.7°F \text{ db}$$

$$52.7°F \text{ wb}$$

$$52.7°F \text{ dp}$$

4. Determine leaving unit temperature in standard cooling mode.

Repeat Step 3a substituting **net** sensible or latent capacity for **gross** sensible or latent capacity to find the leaving unit temperature including fan heat.

$$53.7°F \text{ db}$$

$$53.1°F \text{ wb}$$

5. Determine reheat temperature rise.

Using the leaving evaporator temp (SA'), go to Table 22, p. 46 and determine the reheat temperature rise for that particular cfm:  $\cong 17.0°F \text{ db}$



# Precedent 3-5 Ton Packaged Cooling Selection Procedure

---

**Note:** Reheat temperature rise is based on **supply airflow** and leaving **evaporator coil** temperature.

6. Determine leaving unit sensible temperature with reheat active (SA)  
Reheat temperature (obtained in step 4) + (SA' + fan heat) = SA

**Note:** (SA' + fan heat) = leaving unit temperature in standard cooling mode from step 3b.

$$19.0^{\circ}\text{F db} + 53.7^{\circ}\text{F} = 72.7^{\circ}\text{F db}$$

$$\text{SA} = 72.7^{\circ}\text{F}$$

Since reheat adds only sensible heat, the dewpoint temperature will remain constant so follow the dewpoint temperature line across the psychrometric chart to find the new wb temperature.

$$\pm 60.5^{\circ}\text{F wb}$$

$$52.7 \text{ dp}$$

$$49.9\% \text{ RH}$$

If the space relative humidity is equal to or above the space relative humidity setpoint, the Dehumidification option will:

- Energize compressor
- Hot gas reheat valve is energized and hot gas is diverted to the reheat coil
- Dehumidification/reheat is terminated when space humidity is reduced to 5% below relative humidity setpoint

At MA air enters the RTU. The RTU filters, cools, and dehumidifies the air as it moves through the evaporator coil. Air leaves the evaporator coil saturated at the preset dew point condition (SA') and is reheated by the hot gas reheat coil to deliver 72.7°F (SA) supply air to the space.

# Precedent

## 3-5 Ton Packaged Cooling

### Model Number Description

#### Digit 1 - Unit Type

- T DX Cooling
- Y DX Cooling, Gas Heat

#### Digit 2 - Efficiency

- H High Efficiency

#### Digit 3 - Airflow

- C Convertible

#### Digit 4,5,6 - Nominal Gross Cooling Capacity (MBh)

- 037 3 Ton
- 047 4 Ton
- 067 5 Ton

#### Digit 7 - Major Design Sequence

- E R-410A Refrigerant

#### Digit 8 - Voltage Selection

- 3 208-230/60/3
- 4 460/60/3
- W 575/60/3

#### Digit 9 - Unit Controls

- R ReliaTel™ Microprocessor

#### Digit 10 - Heating Capacity

**Note:** Applicable to Digit 1, T models only

- 0 No Electric Heat
- B 6 kW (3 phase)
- E 12 kW (3 phase)
- G 18 kW (1and 3 phase)
- J 23 kW (3 phase)

**Note:** Applicable to Digit 1, Y models only

- L Low Heat
- M Medium Heat
- H High Heat
- X Low Heat, Stainless Steel Heat Exchanger
- Y Medium Heat, Stainless Steel Heat Exchanger
- Z High Heat, Stainless Steel Heat Exchanger

#### Digit 11 - Minor Design Sequence

- A First Sequence<sup>14</sup>

#### Digit 12,13 - Service Sequence

- \*\* Factory Assigned

#### Digit 14 - Fresh Air Selection

- 0 No Fresh Air
- A Manual Outside Air Damper 0-50%<sup>2</sup>
- B Motorized Outside Air Damper 0-50%
- C Economizer, Dry Bulb 0-100% without Barometric Relief<sup>5</sup>
- D Economizer, Dry Bulb 0-100% with Barometric Relief<sup>5</sup>
- E Economizer, Reference Enthalpy 0-100% without Barometric Relief<sup>5</sup>
- F Economizer, Reference Enthalpy 0-100% with Barometric Relief<sup>5</sup>
- G Economizer, Comparative Enthalpy 0-100% without Barometric Relief<sup>5</sup>
- H Economizer, Comparative Enthalpy 0-100% with Barometric Relief<sup>5</sup>
- K Low Leak Economizer with Barometric Relief
- M Low Leak Economizer with Reference Enthalpy with Barometric Relief
- P Low Leak Economizer with Comparative Enthalpy with Barometric Relief

#### Digit 15 - Supply Fan/Drive Type/Motor

- 0 Standard Drive<sup>4</sup>
- 6 Single Zone VAV<sup>18</sup>
- E VAV Supply Air Temperature Control Standard Motor<sup>18</sup>

#### Digit 16 - Hinged Service Access/ Filters

- 0 Standard Panels/Standard Filters
- A Hinged Access Panels/Standard Filters
- B Standard Panels/2 inch MERV 8 Filters
- C Hinged Access Panels/2 inch MERV 8 Filters
- D Standard Panels/2 inch MERV 13 Filters
- E Hinged Access Panels/2 inch MERV 13 Filters

#### Digit 17 - Condenser Coil Protection

- 0 Standard Coil
- 1 Standard Coil with Hail Guard
- 2 Black Epoxy Pre-Coated Condenser Coil
- 3 Black Epoxy Pre-Coated Condenser Coil with Hail Guard
- 4 CompleteCoat™ Condenser Coil
- 5 CompleteCoat™ Condenser Coil with Hail Guard

#### Digit 18 - Through the Base Provisions

- 0 No Through-the-Base Provisions
- A Through-the-Base Electric<sup>6</sup>
- B Through-the-Base Gas Piping<sup>12</sup>
- C Through-the-Base Electric and Gas Piping<sup>12</sup>

#### Digit 19 - Disconnect/Circuit Breaker (three-phase only)

- 0 No Disconnect/No Circuit Breaker
- 1 Unit Mounted Non-Fused Disconnect<sup>6</sup>
- 2 Unit Mounted Circuit Breaker<sup>6</sup>

#### Digit 20 - Convenience Outlet

- 0 No Convenience Outlet
- A Unpowered Convenience Outlet
- B Powered Convenience Outlet (three-phase only)<sup>7</sup>

#### Digit 21 - Communications Options

- 0 No Communications Interface
- 2 LonTalk® Communications Interface
- 6 BACnet® Communications Interface
- 7 Air-Fi® Wireless Communications<sup>19</sup>

#### Digit 22 - Refrigeration System Option

- 0 Standard Refrigeration System<sup>8</sup>
- B Dehumidification Option<sup>15</sup>

#### Digit 23 - Refrigeration Controls

**Note:** Applicable to Digit 7 = E

- 0 No Refrigeration Control<sup>3</sup>
- 1 Frostat™
- 2 Crankcase Heater<sup>1</sup>
- 3 Frostat and Crankcase Heater<sup>1</sup>

#### Digit 24 - Smoke Detector<sup>13</sup>

- 0 No Smoke Detector
- A Return Air Smoke Detector<sup>9,10</sup>
- B Supply Air Smoke Detector
- C Supply and Return Air Smoke Detectors<sup>9,10</sup>
- D Plenum Smoke Detector

#### Digit 25 - System Monitoring Controls

- 0 No Monitoring Control<sup>11</sup>
- 1 Clogged Filter Switch<sup>11</sup>
- 2 Fan Failure Switch<sup>11</sup>
- 3 Discharge Air Sensing Tube<sup>11</sup>
- 4 Clogged Filter Switch and Fan Failure Switch<sup>11</sup>
- 5 Clogged Filter Switch and Discharge Air Sensing Tube<sup>11</sup>
- 6 Fan Failure Switch and Discharge Air Sensing Tube<sup>11</sup>
- 7 Clogged Filter Switch, Fan Failure Switch and Discharge Air Sensing Tube<sup>11</sup>

- A Condensate Drain Pan Overflow Switch

# Precedent 3-5 Ton Packaged Cooling Model Number Description

- B Clogged Filter Switch<sup>11</sup> and Condensate Drain Pan Overflow Switch
- C Fan Failure Switch<sup>11</sup> and Condensate Drain Pan Overflow Switch
- D Discharge Air Sensing<sup>11</sup> and Condensate Drain Pan Overflow Switch
- E Clogged Filter Switch<sup>11</sup>, Fan Failure Switch<sup>11</sup> and Condensate Drain Pan Overflow Switch
- F Clogged Filter Switch<sup>11</sup>, Discharge Air Sensing Tube<sup>11</sup> and Condensate Drain Pan Overflow Switch
- G Fan Failure Switch<sup>11</sup>, Discharge Air Sensing Tube<sup>11</sup> and Condensate Drain Pan Overflow Switch
- H Clogged Filter Switch<sup>11</sup>, Fan Failure Switch<sup>11</sup>, Discharge Air Sensing<sup>11</sup> and Condensate Drain Pan Overflow Switch

## Digit 26 - System Monitoring Controls

- 0 No Monitoring Controls
- A Demand Control Ventilation (CO<sub>2</sub>)<sup>16,17</sup>

## Digit 27 - Unit Hardware Enhancements

- 0 No Enhancements
- 1 Stainless Steel Drain Pan

## Digit 31 - Advanced Unit Controls

- 0 Standard Unit Controls
- 1 Human Interface

## Digit 34 - Ultra Low NOx Gas Furnace (CA Only)

- 0 - None
- A - 14 ng/J NOx Emissions <sup>20,21,22,23,24,25</sup>

## Model Number Notes

1. Standard on all variable stage units.
2. Manual outside air damper will ship factory supplied within the unit, but must be field installed.
3. High pressure control is standard on all units.
4. Direct drive is standard for 3 to 5 ton variable stage units.

### Digit 15 = 0, 6

3 Phase (3-5 ton) - High Efficiency Constant CFM

5. Economizer with Barometric Relief is for downflow configured units only. Order Economizer without Barometric Relief for horizontal configuration.

Barometric Relief for horizontal configured units must be ordered as field installed accessory.

6. Through the base electric required when ordering disconnect/circuit breaker options.
7. Requires use of Disconnect or Circuit Breaker.

### Not Available

High Efficiency  
3-5 ton w/Standard Indoor Motor w/460V or 575V

8. Standard metering devices are TXVs.
9. The return air smoke detector may not fit up or work properly on the Precedent units when used in conjunction with 3rd party accessories such as bolt on heat wheels, economizers and power exhaust. Do not order the return air smoke detectors when using this type of accessory.
10. Return Air Smoke Detector cannot be ordered with Novar Controls.
11. These options are standard when ordering Novar Controls.
12. Includes gas piping and shutoff (field assembly required).
13. Not available with high temperature duct sensor accessory.
14. Available for T/Y 3,4,5 ton high efficiency models.
15. Requires selection of 2 inch Pleated Filters (option B or C) for Digit 16.
16. Demand Control Ventilation not available with electromechanical controls.
17. Demand Control Ventilation Option includes wiring only. The CO<sub>2</sub> sensor is a field-installed only option.
18. Discharge Air Sensing is also standard equipment on units with Single Zone and Supply Air Temperature Control VAV.
19. Must be used with BACnet® open protocol.

20. No 575V with Ultra Low NOx
21. Ultra Low NOx requires SSHX Option (Digit 10 = X or Y)
22. Ultra Low NOx has 3T Only available with LOW heat (digit 10=X)
23. Ultra Low NOx has NO High Heat Available
24. High Altitude kit is not available with Ultra Low NOx option
25. LP Conversion kit is not available with Ultra Low NOx option.

# Precedent 3-5 Ton Packaged Cooling General Data

**Table 1. General data - 3 to 5 tons 17 Plus**

	3 Tons	4 Tons	5 Tons
	T/YHC037E3,4,W <sup>(a)</sup>	T/YHC047E3,4,W <sup>(a)</sup>	T/YHC067E3,4,W <sup>(a)</sup>
<b>Cooling Performance<sup>(b)</sup></b>			
Gross Cooling Capacity - High Stage	36,500	50,500	60,000
EER/SEER <sup>(c)</sup>	13.0/17.5	13.0/17.5	13.0/17.2
Nominal CFM-High Stage/AHRI Rated CFM	1,200/1,200	1,600/1,600	2,000/2,000
Nominal CFM-Low Stage	840	1,120	1,400
AHRI Net Cooling Capacity-High Stage	36,000	49,000	58,500
System Power-High Stage (KW)	2.78	3.67	4.57
<b>Compressor</b>			
No./Type	1/Scroll (2 Stage)	1/Scroll (2 Stage)	1/Scroll (2 Stage)
<b>Outdoor Sound Rating (dB)<sup>(d)</sup></b>			
	81	87	87
<b>Outdoor Coil - Type</b>			
Tube Size (in.) OD	Lanced	Lanced	Lanced
Face Area (sq. ft)	0.3125	0.3125	0.3125
Rows/FPI	17.00	17.00	17.00
	3/17	3/16	3/16
<b>Indoor Coil - Type</b>			
Tube Size (in.) OD	Lanced	Lanced	Lanced
Face Area (sq. ft)	0.3125	0.3125	0.3125
Rows/FPI	7.71	9.27	9.89
	3/16	3/16	4/16
Refrigerant Control	Thermal Expansion Valve	Thermal Expansion Valve	Thermal Expansion Valve
Drain Connection No./Size (in.)	1 3/4 NPT	1 3/4 NPT	1 3/4 NPT
<b>Outdoor Fan - Type</b>			
No. Used / Diameter (in.)	Propeller	Propeller	Propeller
Drive Type / No. Speeds	1/22	1/26	1/26
CFM	Direct/1	Direct/1	Direct/1
Motor HP	3064	3982	3953
Motor RPM	0.2/0.4	0.4	0.4
	1075	1075	1075
<b>Indoor Fan - Type (Optional)</b>			
No. Used / Diameter (in.)	FC Centrifugal	FC Centrifugal	FC Centrifugal
Drive Type / Number. Speeds	1/11 x 11	1/11 x 11	1/11 x 11
Number Motors	Direct/Variable	Direct/Variable	Direct/Variable
Motor HP (Standard/Oversized)	1	1	1
Motor Frame Size (Standard/Oversized)	0.75	1.0	1.0
	48	48	48
<b>Filters - Type Furnished<sup>(e)</sup></b>			
(No.) Size Recommended	Throwaway	Throwaway	Throwaway
	(2) 20 x 30 x 2	(4) 16 x 25 x 2	(4) 16 x 25 x 2
<b>Optional Hot Gas Reheat Coil -Type</b>			
Tube Size (in.)OD	0.3125	0.3125	0.3125
Face Area (sq. ft.)	5.23	6.28	6.28
Rows/FPI	1/16	1/16	1/16
<b>Refrigerant Charge (Lbs of R-410A)<sup>(f)</sup></b>			
Standard	7.8	10.8	12.5
Optional Hot Gas Reheat Coil	10.5	15.2	15.3

# Precedent 3-5 Ton Packaged Cooling General Data

**Table 1. General data - 3 to 5 tons 17 Plus**

	3 Tons			4 Tons			5 Tons		
	T/YHC037E3,4,W <sup>(a)</sup>			T/YHC047E3,4,W <sup>(a)</sup>			T/YHC067E3,4,W <sup>(a)</sup>		
<b>Gas/Electric Only</b>									
<b>Heating Performance<sup>(g)</sup></b>									
Heating Models	<b>Low</b>	<b>Med</b>	<b>High</b>	<b>Low</b>	<b>Med</b>	<b>High</b>	<b>Low</b>	<b>Med</b>	<b>High</b>
Heating Input (Btu)	60,000	80,000	100,000	60,000	80,000	120,000	60,000	80,000	130,000
Heating Output (Btu)	48,000	64,000	80,000	49,000	64,000	96,000	49,000	64,000	104,000
Steady State Efficiency (%)	80%	80%	81%	81%	80%	81%	81%	80%	80%
No. Burners	2	2	3	2	2	3	2	2	3
No. Stages	1	1	1	1	1	1	1	1	1
<b>Gas Supply Line Pressure</b>									
Natural (minimum / maximum)	4.5/14.0			4.5/14.0			4.5/14.0		
LP (minimum / maximum)	11/14.0			11/14.0			11/14.0		
<b>Gas Connection Pipe Size (in.)</b>	1/2	1/2	1/2	1/2	1/2	1/2	1/2	1/2	1/2

- (a) 575 (W voltage) is only available as YHC. No THC models available with 575V (W voltage).  
 (b) High Stage Cooling Performance is rated at 95°F ambient, 80°F entering dry bulb, 67°F entering wet bulb. Gross capacity does not include the effect of fan motor heat. AHRI capacity is net and includes the effect of fan motor heat. Units are suitable for operation to ±20% of nominal cfm. Units are certified in accordance with the Unitary Air-Conditioner Equipment certification program, which is based on AHRI standard 210/240.  
 (c) EER and/or SEER are rated at AHRI conditions and in accordance with DOE test procedures.  
 (d) Outdoor Sound Rating shown is tested in accordance with AHRI Standard 270. For additional information refer to Table 16, p. 44.  
 (e) Optional 2 inch MERV 8 and MERV 13 pleated filters also available.  
 (f) Refrigerant charge is an approximate value. For a more precise value, see unit nameplate and service instructions.  
 (g) Heating performance limit settings and rating data were established and approved under laboratory test conditions using American National Standards Institute standards. Ratings shown are for elevations up to 2000 feet. For elevations above 2000 feet, ratings should be reduced at the rate of 4% for each 1000 feet above sea level. Applicable to Gas/Electric units only.

**Table 2. General data - 3 to 5 tons 17 Plus with Ultra Low NOx gas**

<b>Ultra Low NOx Digit 34 = A</b>	<b>3 Tons YHC037E3,4<sup>(a)</sup></b>	<b>4 Tons YHC047E3,4<sup>(a)</sup></b>	<b>5 Tons YHC067E3,4<sup>(a)</sup></b>
<b>Heating Performance<sup>(b)</sup></b>			
Heat Models	<b>Low</b>	<b>Low</b>	<b>Med</b>
Heating Input (Btu)	60,000	60,000	90,000
Heating Output (Btu)	48,600	48,600	72,900
Stead State Efficiency (%)	81%	81%	81%
No. Burners	2	2	3
No. Stages	1	1	1
<b>Gas Supply Line Pressure</b>			
Natural (minimum / maximum)	4.5/14.0	4.5/14.0	4.5/14.0
<b>Gas Connection Pipe Size (in.)</b>	1/2	1/2	1/2

- (a) No digit 8, W, 575 volt offered on Ultra Low NOx gas furnace option.  
 (b) Ultra Low NOx gas furnace option not available for High Altitude installations above 2000 feet.

# Precedent 3-10 Ton Packaged Heat Pumps Selection Procedure

## Cooling Capacity

- Calculate the building's total and sensible cooling loads at design conditions. Use the American Standard® calculation methods or any other standard accepted method.  
 Factors used in unit selection:
  - Total Cooling Load: 71 MBh
  - Sensible Cooling Load: 45 MBh
  - Airflow: 2400 cfm
  - Electrical Characteristics: 460/60/3
  - Summer Design Conditions: Entering
  - Evaporator Coil: 80 DB, 67 WB Outdoor Ambient: 95
  - External Static Pressure: 0.47 in. wg
  - Downflow Configuration
  - Economizer
- As a starting point, a rough determination **must** be made of the size of the unit. The final selection will be made after examining the performance at the given conditions. Divide the total cooling load by nominal BTUH per ton (12 MBh per ton); then round up to the nearest unit size.  
 $71 \text{ MBh} / 12 \text{ MBh} = \text{approx. } 6 \text{ tons}$
- Table 13, p. 38 shows that a WSC072H4 has a **gross** cooling capacity of 78.0 MBh and 56.7 MBh sensible capacity at 2400 cfm and 95 DB outdoor ambient with 80 DB, 67 WB air entering the evaporator.

### To Find Capacity at Intermediate Conditions not in the table

When the design conditions are between two numbers that are in the capacity table, interpolation is required to approximate the capacity.

**Note:** *Extrapolation outside of the table conditions is not recommended.*

- In order to select the correct unit which meets the building's requirements, the fan motor heat must be deducted from the gross cooling capacity. The amount of heat that the fan motor generates is dependent on the effort by the motor - cfm and static pressure. To determine the total unit static pressure:

External Static Duct System	0.47 wg
Economizer from Table 89, p. 108 (100% Outside Air)	0.11 wg
Electric Heater Size 9 kW from Table 89, p. 108	0.02 wg
Total Static Pressure	0.60 wg

**Note:** (reference "Heating Capacity" section on this page for determination of heater size)

With 2400 cfm and 0.60 wg, Table 38, p. 62 shows 0.75 bhp for this unit. Note below the table gives a formula to calculate Fan Motor Heat,

$$2.829 \times \text{bhp} + 0.4024 = \text{MBh}$$

$$2.829 \times 0.75 + 0.4024 = 2.52 \text{ MBh}$$

Now subtract the fan motor heat from the gross cooling capacity of the unit:

$$\text{Net Total Cooling Capacity}$$

$$= 78.0 \text{ MBh} - 2.52 = 75.48 \text{ MBh}$$

$$\text{Net Sensible Cooling Capacity}$$

$$= 56.74 \text{ MBh} - 2.52 = 54.22 \text{ MBh}$$

# Precedent 3-10 Ton Packaged Heat Pumps Selection Procedure

---

5. Compare results to original load requirements. If the performance will not meet the required total or sensible cooling load, try a selection at the next higher size unit.

## Heating Capacity

1. Calculate the building heating load using the American Standard® calculation form or other standard accepted method.
2. Size the equipment using Table 93, p. 113 to match the heating loads at design conditions.  
Total heating load of 65 MBh  
Outdoor Ambient (Winter): 17 DB  
Indoor Return Temperature: 60 DB  
Airflow: 2400 cfm  
Use the integrated portion of Table 93, p. 113 for WSC072 to determine capacity at winter design conditions. The mechanical heating portion of the heat pump will provide 40.5 MBh.
3. Because 40.5 is less than the building's required heating capacity at winter design conditions, a supplementary heater must be selected.  
 $65 \text{ MBh} - 40.5 \text{ MBh} = 24.5 \text{ MBh}$   
The auxiliary electric heat capacities are listed in Table 112, p. 125. From the table, a 9 kW heater will deliver 30.73 MBh at 480 volts. In order to determine capacity at 460 volts, the heater voltage correction factor from Table 114, p. 126 must be used. Therefore,  $30.73 \text{ MBh} \times .918$  (voltage correction factor) = 28.2 MBh. A 9 kW heater should be selected.

## Air Delivery Selection

External static pressure drop through the air distribution system has been calculated to be 0.60 inches of water. Enter Table 38, p. 62 for a WSC072H4 at 2400 cfm and 0.60 static pressure. The belt drive motor will give the desired airflow at a rated bhp of 0.75 and 847 rpm.

# Precedent 3-10 Ton Packaged Heat Pumps Model Number Description

## Digit 1 - Unit Type

- W = Packaged Heat Pump<sup>2</sup>
- D = Dual Fuel Heat Pump<sup>2</sup>

## Digit 2 - Efficiency

- S = Standard Efficiency
- H = High Efficiency

## Digit 3 - Airflow

- C = Convertible

## Digit 4,5,6 - Nominal Gross Cooling Capacity (MBh)

- 036 = 3 Ton
- 048 = 4 Ton
- 060 = 5 Ton
- 072 = 6 Ton
- 074 = 6 Ton
- 090 = 7.5 Ton
- 092 = 7.5 Ton
- 102 = 8.5 Ton
- 120 = 10 Ton

## Digit 7 - Major Design Sequence

### Digit 8 - Voltage Selection

- 3 = 208-230/60/3
- 4 = 460/60/3
- W = 575/60/3

### Digit 9 - Unit Controls

- R = ReliaTel™ Microprocessor

### Digit 10 - Heating Capacity

**Note:** Applicable to Digit 1,W models only.

- 0 = No Electric Heat
- B = 6 kW
- C = 9 kW
- E = 12 kW
- G = 18 kW
- J = 23 kW
- K = 27 kW
- N = 36 kW
- P = 54 kW

**Note:** Applicable to Digit 1,D models only

- L = Low Heat
- M = Medium Heat
- H = High Heat
- X = Low Heat, Stainless Steel Heat Exchanger
- Y = Medium Heat, Stainless Steel Heat Exchanger
- Z = High Heat, Stainless Steel Heat Exchanger

### Digit 11 - Minor Design Sequence

### Digit 12,13 - Service Sequence

\*\* Factory Assigned

### Digit 14 - Fresh Air Selection

- 0 = No Fresh Air
- A = Manual Outside Air Damper 0-50%<sup>1</sup>
- B = Motorized Outside Air Damper 0-50%<sup>10</sup>

- C = Economizer, Dry Bulb 0-100% without Barometric Relief<sup>4</sup>
- D = Economizer, Dry Bulb 0-100% with Barometric Relief<sup>4</sup>
- E = Economizer, Reference Enthalpy 0-100% without Barometric Relief<sup>4</sup>
- F = Economizer, Reference Enthalpy 0-100% with Barometric Relief<sup>4</sup>
- G = Economizer, Comparative Enthalpy 0-100% without Barometric Relief<sup>4</sup>
- H = Economizer, Comparative Enthalpy 0-100% with Barometric Relief<sup>4</sup>
- K = Low Leak Economizer with Barometric Relief
- M = Low Leak Economizer with Reference Enthalpy with Barometric Relief
- P = Low Leak Economizer with Comparative Enthalpy with Barometric Relief

### Digit 15 - Supply Fan/Drive Type/Motor

- 0 = Standard Drive<sup>3</sup>
- 1 = Oversized Motor<sup>3</sup>
- 2 = Optional Belt Drive Motor
- 6 = Single Zone Variable Air Volume (SZVAV)<sup>14</sup>
- 7 = Multi-Speed Indoor Fan<sup>12</sup>
- 8 = Single Zone Variable Air Volume (SZVAV) w/Oversized Motor<sup>14</sup>
- E = Multi-Zone Variable Air Volume (MZVAV)<sup>14</sup>
- F = Multi-Zone Variable Air Volume (MZVAV) w/Oversized Motor<sup>14</sup>

### Digit 16 - Hinged Service Access/ Filters

- 0 = Standard Panels/Standard Filters
- A = Hinged Access Panels/Standard Filters
- B = Standard Panels/2" MERV 8 Filters
- C = Hinged Access Panels/2" MERV 8 Filters
- D = Standard Panels/2" MERV 13 Filters
- E = Hinged Access Panels/2" MERV 13 Filters

### Digit 17 - Condenser Coil Protection

- 0 = Standard Coil
- 1 = Standard Coil with Hail Guard
- 2 = Black Epoxy Pre-Coated Condenser Coil
- 3 = Black Epoxy Pre-Coated Condenser Coil with Hail Guard

### Digit 18 - Through-the-Base Provisions

- 0 = No Through-the-Base Provisions
- A = Through-the-Base Electric<sup>5</sup>

- B = Through-the-Base Gas Piping<sup>17</sup>
- C = Through-the-Base Electric and Gas Piping<sup>17</sup>

### Digit 19 - Disconnect/Circuit Breaker (three-phase only)

- 0 = No Disconnect/No Circuit Breaker
- 1 = Unit Mounted Non-Fused Disconnect<sup>5</sup>
- 2 = Unit Mounted Circuit Breaker<sup>5</sup>

### Digit 20 - Convenience Outlet

- 0 = No Convenience Outlet
- A = Unpowered Convenience Outlet
- B = Powered Convenience Outlet (three-phase only)<sup>6</sup>

### Digit 21 - Communications Options

- 0 = No Communications Interface
- 1 = American Standard® Communications Interface
- 2 = LonTalk® Communications Interface
- 6 = BACnet® Communications Interface
- 7 = Air-Fi® Wireless Communications<sup>15</sup>

### Digit 22 - Refrigeration System Option

- 0 = Standard Refrigeration System<sup>7</sup>

### Digit 23 - Refrigeration Controls

- 0 = No Refrigeration Control<sup>2</sup>
- 1 = Frostat™<sup>11</sup>
- 2 = Crankcase Heater<sup>16</sup>
- 3 = Frostat and Crankcase Heater<sup>11,16</sup>

### Digit 24 - Smoke Detector

- 0 = No Smoke Detector
- A = Return Air Smoke Detector<sup>8</sup>
- B = Supply Air Smoke Detector
- C = Supply and Return Air Smoke Detectors<sup>8</sup>
- D = Plenum Smoke Detector

### Digit 25 - System Monitoring Controls

- 0 = No Monitoring Control
- 1 = Clogged Filter Switch
- 2 = Fan Failure Switch
- 3 = Discharge Air Sensing Tube
- 4 = Clogged Filter Switch and Fan Fail Switch
- 5 = Clogged Filter Switch and Discharge Air Sensing Tube
- 6 = Fan Fail Switch and Discharge Air Sensing Tube
- 7 = Clogged Filter and Fan Fail Switches and Discharge Air Sensing Tube
- A = Condensate Drain Pan Overflow Switch
- B = Clogged Filter Switch and Condensate Drain Pan Overflow Switch
- C = Fan Failure Switch and



# Precedent 3-10 Ton Packaged Heat Pumps Model Number Description

- D = Condensate Drain Pan Overflow Switch  
Discharge Air Sensing and Condensate Drain Pan Overflow Switch
- E = Clogged Filter Switch, Fan Failure Switch and Condensate Drain Pan Overflow Switch
- F = Clogged Filter Switch, Discharge Air Sensing Tube and Condensate Drain Pan Overflow Switch
- G = Fan Failure Switch, Discharge Air Sensing Tube and Condensate Drain Pan Overflow Switch
- H = Clogged Filter Switch, Fan Failure Switch, Discharge Air Sensing and Condensate Drain Pan Overflow Switch

## Digit 26 - System Monitoring Controls

- 0 = No Monitoring Controls
- A = Demand Control Ventilation (CO<sub>2</sub>)<sup>13</sup>
- B = Low Leak Economizer with FDD (Fault Detection and Diagnostics)
- C = FDD (Fault Detection and Diagnostics) with DCV (Demand Control Ventilation)

## Digit 27 - Unit Hardware Enhancements

- 0 = No Enhancements
- 1 = Stainless Steel Drain Pan

## Digit 31 - Advanced Unit Controls

- 0 = Standard Unit Controls
- 1 = Human Interface

## Model Number Notes

1. Manual outside air damper will ship factory supplied within the unit, but must be field installed.
2. High pressure control is standard on all units.
3. Multi-stage, direct drive standard on 3 to 5 tons models. Belt drive standard on 6 to 8.5 tons standard efficiency models. Variable speed direct drive standard on 10 tons models and 6 to 8.5 tons high efficiency models.
4. Economizer with barometric relief is for downflow configured units only. Order economizer without barometric relief for horizontal configuration. Barometric relief for horizontal configured units must be ordered as field installed accessory.
5. Through-the-base electric required when ordering disconnect/circuit breaker options.
6. Requires use of disconnect or circuit breaker.
7. Standard metering devices are TXVs.
8. The return air smoke detector may not fit up or work properly on the Precedent™ units when used in conjunction with 3rd party accessories such as bolt on heat wheels, economizers and power exhaust. Do not order the return air smoke detectors when using this type of accessory.
9. Requires hinged access panels.
10. Motorized outside air damper is not available on Multi-Speed or SZVAV (Single Zone Variable Air Volume) or MZVAV (Multi Zone Variable Air Volume) products.
11. Froststat™ standard on 6 to 10 tons high efficiency heat pump, multi-speed and SZVAV (single zone variable air volume) products.
12. Multi-speed indoor fan available on 6, 7.5, 8.5 and 10 tons products.
13. Demand control ventilation option includes wiring only. The CO<sub>2</sub> sensor is a field-installed only option.
14. SZVAV/MZVAV is available on all high efficiency models. SZVAV is also available on 7.5 to 10 tons standard efficiency models.
15. Must be used with BACnet® open protocol.
16. Crankcase heater is standard on all 3 to 10 tons heat pumps.
17. Includes gas piping and shutoff (field assembly required).

COPY

# Precedent 3-10 Ton Packaged Heat Pumps General Data

**Table 3. General data - 3 to 5 tons - standard efficiency**

	<b>3 Tons</b>	<b>4 Tons</b>	<b>5 Tons</b>
	<b>WSC036H3,4,W</b>	<b>WSC048H3,4,W</b>	<b>WSC060H3,4,W</b>
<b>Cooling Performance<sup>(a)</sup></b>			
Gross Cooling Capacity	39,500	50,000	61,000
EER/SEER <sup>(b)</sup>	3,4 = 12.1/14.3 W = 12.0/14.3	3,4 = 12.3/14.3 W = 12.2/14.3	3,4 = 12.3/14.3 W = 12.2/14.3
Nominal cfm/AHRI Rated cfm	1,200/1,200	1,600/1,600	2,000/2,000
AHRI Net Cooling Capacity	39,000	49,000	60,000
System Power (kW)	3.22	3.98	4.88
<b>Heating Performance<sup>(c)</sup></b>			
High Temp. Btuh Rating	36,000	47,500	59,000
System Power kW/COP	3.01/3.50	3.98/3.50	4.94/3.50
Low Temp. Btuh Rating	20,600	26,000	35,000
System Power kW/COP	2.74/2.20	3.31/2.30	4.46/2.30
HSPF (Btu/Watts-hr)	8.00	8.20	8.20
<b>Compressor</b>			
Number/Type	1/Scroll	1/Scroll	1/Scroll
<b>Sound</b>			
Outdoor Sound Rating (dB) <sup>(d)</sup>	81	82	87
<b>Outdoor Coil</b>			
Type	Lanced	Lanced	Lanced
Tube Size (in.)	0.3125	0.3125	0.3125
Face Area (sq. ft.)	12.33	12.33	17.00
Rows/FPI	2/16	3/16	3/16
Refrigerant Control	Thermal Expansion Valve	Thermal Expansion Valve	Thermal Expansion Valve
<b>Indoor Coil</b>			
Type	Lanced	Lanced	Lanced
Tube Size (in.)	0.3125	0.3125	0.3125
Face Area (sq. ft.)	8.74	8.74	9.27
Rows/FPI	3/16	3/16	3/16
Refrigerant Control	Thermal Expansion Valve	Thermal Expansion Valve	Thermal Expansion Valve
Drain Connection Number/Size (in.)	1¾ NPT	1¾ NPT	1¾ NPT
<b>Outdoor Fan</b>			
Type	Propeller	Propeller	Propeller
Number Used/Diameter (in.)	1/22	1/22	1/26
Drive Type/No. Speeds	Direct/1	Direct/1	Direct/1
cfm	3,600	4,050	5,130
Motor hp	0.25	0.33	0.40
Motor rpm	1,100	1,100	1,100

# Precedent 3-10 Ton Packaged Heat Pumps General Data

**Table 3. General data - 3 to 5 tons - standard efficiency (continued)**

	3 Tons	4 Tons	5 Tons
	WSC036H3,4,W	WSC048H3,4,W	WSC060H3,4,W
<b>Indoor Fan</b>			
Type (Standard)	FC Centrifugal	FC Centrifugal	FC Centrifugal
Number Used/Diameter (in.)/Width (in.)	1/11x11	1/11x11	1/11x11
Drive Type/No. Speeds/rpm	Direct/5 <sup>(e)</sup>	Direct/5 <sup>(e)</sup>	Direct/5 <sup>(e)</sup>
Motor hp (standard/oversized)	0.75/1.5	1.0/1.5	1.0/1.5
Motor Frame Size (standard/oversized)	48/48	48/48	48/48
<b>Filters<sup>(f)</sup></b>			
Type Furnished	Throwaway	Throwaway	Throwaway
Number Size Recommended	(2) 20x35x2	(2) 20x35x2	(4) 16x25x2
<b>Refrigerant Charge<sup>(g)</sup></b>			
Pounds of R-410A	7.7	9.3	11.5

- (a) Cooling performance is rated at 95°F ambient, 80°F entering dry bulb, 67°F entering wet bulb. Gross capacity does not include the effect of fan motor heat. AHRI capacity is net and includes the effect of fan motor heat. Units are suitable for operation to ±20% of nominal cfm. Units are certified in accordance with the Unitary Air-Conditioner Equipment certification program, which is based on AHRI Standard 210/240.
- (b) EER and/or SEER are rated at AHRI conditions and in accordance with DOE test procedures.
- (c) Heating performance is rated at 47°F ambient with 43°F wet bulb, 70°F entering dry bulb, 60°F entering wet bulb. High temp. Btuh rating includes the effect of fan motor heat. Units are suitable for operation to ±20% of nominal cfm. Units are certified in accordance with the Unitary Air-Conditioner Equipment certification program, which is based on AHRI Standard 210/240.
- (d) Outdoor sound rating shown is tested in accordance with AHRI Standard 270. For additional information reference the outdoor sound power level data in the performance section.
- (e) For multispeed direct drive rpm values, reference the direct drive, evaporator fan performance table.
- (f) Optional 2" MERV 8 and MERV 13 filters also available.
- (g) Refrigerant charge is an approximate value. For a more precise value, see unit nameplate and service instructions.

**Table 4. General data - 6 to 10 tons - standard efficiency**

	6 Tons	7.5 Tons	7.5 Tons	8.5 Tons	10 Tons
	WSC072H3,4,W	WSC090H3,4,W	WSC092H3,4,W	WSC102H3,4,W	WSC120H3,4,W
<b>Cooling Performance<sup>(a)</sup></b>					
Gross Cooling Capacity	78,000	93,500	95,300	103,200	118,100
EER <sup>(b)</sup>	11.4	11.1	11.3	11.0	11.0
Nominal cfm/AHRI Rated cfm	2,400/2,100	3,000/2,625	3,000/3,000	3,400/3,315	4,000/4,000
AHRI Net Cooling Capacity	75,000	90,000	93,000	100,000	115,000
IEER <sup>(c)</sup>	13.0	12.2	12.4 <sup>(d)</sup>	12.2 <sup>(d)</sup>	12.2 <sup>(d)</sup>
System Power (kW)	6.58	8.11	8.23	9.09	10.45
<b>Heating Performance<sup>(e)</sup></b>					
High Temp. Btuh Rating	71,000	87,000	88,000 <sup>(f)</sup>	92,000 <sup>(f)</sup>	106,000
System Power kW/COP	5.95/3.50	7.50/3.40	7.59/3.40	7.93/3.40	9.14/3.40
Low Temp. Btuh Rating	39,000	48,000	48,000	48,500	58,500
System Power kW/COP	5.2/2.30	6.25/2.25	6.25/2.25	6.77/2.10	7.62/2.25
HSPF (Btu/Watts-hr)	—	—	—	—	—
<b>Compressor</b>					
Number/Type	1/Scroll	1/Scroll	1/Scroll (2 Stage)	1/Scroll (2 Stage)	1/Scroll (2 Stage)
<b>Sound</b>					
Outdoor Sound Rating (dB) <sup>(g)</sup>	89	86	86	85	86

# Precedent 3-10 Ton Packaged Heat Pumps General Data

**Table 4. General data - 6 to 10 tons - standard efficiency (continued)**

	<b>6 Tons</b>	<b>7.5 Tons</b>	<b>7.5 Tons</b>	<b>8.5 Tons</b>	<b>10 Tons</b>
	<b>WSC072H3,4,W</b>	<b>WSC090H3,4,W</b>	<b>WSC092H3,4,W</b>	<b>WSC102H3,4,W</b>	<b>WSC120H3,4,W</b>
<b>Outdoor Coil - Type</b>	Lanced	Lanced	Lanced	Lanced	Lanced
Configuration	Full Face	Full Face	Full Face	Full Face	Full Face
Tube Size (in.)	0.3125	0.3125	0.3125	0.3125	0.3125
Face Area (sq. ft.)	17.00	19.83	19.83	23.34	23.34
Rows/FPI	3/16	3/16	3/16	3/16	3/16
Refrigerant Control	Thermal Expansion Valve	Thermal Expansion Valve	Thermal Expansion Valve	Thermal Expansion Valve	Thermal Expansion Valve
<b>Indoor Coil - Type</b>	Lanced	Lanced	Lanced	Lanced	Lanced
Configuration	Full Face	Full Face	Full Face	Full Face	Full Face
Tube Size (in.)	0.3125	0.3125	0.3125	0.3125	0.3125
Face Area (sq. ft.)	9.89	12.36	12.36	12.36	12.36
Rows/FPI	4/16	3/16	3/16	4/16	4/16
Refrigerant Control	Orifice	Orifice	Thermal Expansion Valve	Thermal Expansion Valve	Thermal Expansion Valve
Drain Connection Number/Size (in.)	1¾ NPT	1¾ NPT	1¾ NPT	1¾ NPT	1¾ NPT
<b>Outdoor Fan - Type</b>	Propeller	Propeller	Propeller	Propeller	Propeller
Number Used/Diameter (in.)	1/26	1/26	1/26	1/26	1/26
Drive Type/No. Speeds	Direct/1	Direct/1	Direct/1	Direct/1	Direct/1
cfm	5,800	6,200	6,200	6,200	6,200
Motor hp	0.70	0.70	0.70	0.70	0.70
Motor rpm	1,100	1,100	1,100	1,100	1,100
<b>Indoor Fan - Type</b>	FC Centrifugal	FC Centrifugal	FC Centrifugal <sup>(h)</sup>	FC Centrifugal <sup>(h)</sup>	BC Plenum
Number Used/Diameter (in.)/ Width (in.)	1/12x12	1/15 x 15	1/15 x 15 <sup>(i)</sup>	1/15 x 15 <sup>(i)</sup>	1/19.7x15
Drive Type/No. Speeds/rpm	Belt/Variable/1,750	Belt/Variable/1,750	Belt/ Variable/1,750 <sup>(j)</sup>	Belt/ Variable/1,750 <sup>(j)</sup>	Direct/Variable <sup>(k)</sup>
Motor hp (Standard/Oversized)	1.0/2.0	1.0/3.0	1.0/3.0 <sup>(l)</sup>	2.0/3.0 <sup>(l)</sup>	2.75/—
Motor Frame Size (Standard/ Oversized)	56/56	56/56	56/56	56/56	—/—
<b>Filters<sup>(m)</sup> - Type Furnished</b>	Throwaway	Throwaway	Throwaway	Throwaway	Throwaway
Number Size Recommended	(4) 16x25x2	(4) 20x25x2	(4) 20x25x2	(4) 20x25x2	(4) 20x25x2
<b>Refrigerant Charge<sup>(n)</sup></b>					
Pounds of R-410A	12.0	13.8	14.6	18.0	16.3

- (a) Cooling performance is rated at 95°F ambient, 80°F entering dry bulb, 67°F entering wet bulb. Gross capacity does not include the effect of fan motor heat. AHRI capacity is net and includes the effect of fan motor heat. Units are suitable for operation to ±20% of nominal cfm. Units are certified in accordance with the Unitary Air-Conditioner Equipment certification program, which is based on ARI Standard 340/360.
- (b) EER and/or SEER are rated at AHRI conditions and in accordance with DOE test procedures.
- (c) Integrated Efficiency Ratio (IEER) is rated in accordance with AHRI Standard 340/360. The IEER rating requires that the unit efficiency be determined at 100%, 75%, 50% and 25% load (net capacity) at the specified in AHRI Standard.
- (d) 13.4 IEER for SZVAV option, 12.9 IEER for Title 24 2-speed fan option.
- (e) Heating performance is rated at 47°F ambient with 43°F wet bulb, 70°F entering dry bulb, 60°F entering wet bulb. High temp. Btu/h Rating includes the effect of fan motor heat. Units are suitable for operation to ±20% of nominal cfm. Units are certified in accordance with the Unitary Air-Conditioner Equipment certification program, which is based on AHRI Standard 340/360.
- (f) For SZVAV/Title 24 option, 8.5 tons high temp. Btu/h rating = 89,000, 7.5 Tons high temp. Btu/h rating = 87,000.
- (g) Outdoor sound rating shown is tested in accordance with AHRI Standard 270-2015. For additional information reference the outdoor sound power level data in the performance section.
- (h) For SZVAV/Title 24 option, backward airfoil plenum.
- (i) For SZVAV/Title 24 option, 1/19.7x15.
- (j) For SZVAV/Title 24 option, direct/variable.
- (k) For multispeed direct drive rpm values, reference the direct drive, evaporator fan performance table.
- (l) For SZVAV/Title 24 option, 2.75.
- (m) Optional 2" MERV 8 and MERV 13 filters also available.

# Precedent 3-10 Ton Packaged Heat Pumps General Data

(n) Refrigerant charge is an approximate value. For a more precise value, see unit nameplate and service instructions.

**Table 5. General data - 3 to 5 tons - high efficiency**

	<b>3 Tons</b>	<b>4 Tons</b>	<b>5 Tons</b>
	<b>WHC036H3,4,W</b>	<b>WHC048H3,4,W</b>	<b>WHC060H3,4,W</b>
<b>Cooling Performance<sup>(a)</sup></b>			
Gross Cooling Capacity-High Stage	36,400	48,750	61,000
EER/SEER <sup>(b)</sup>	12.5/16.0	13.0/16.5	3=13.0/16.4 4,W=12.9/16.2
Nominal cfm-High Stage/AHRI Rated cfm	1,200/1,200	1,600/1,680	2,000/2,000
Nominal cfm-Low Stage/AHRI Rated cfm	840	1,120	1,400
AHRI Net Cooling Capacity-High Stage	36,000	48,000	60,000
System Power-High Stage (kW)	2.88	3.69	4.62
<b>Heating Performance<sup>(c)</sup></b>			
High Temp. Btuh Rating-High Stage	32,200	44,000	57,000
System Power kW/COP-High Stage	2.62/3.60	3.58/3.60	4.64/3.60
Low Temp. Btuh Rating-High Stage	21,400	24,000	34,400
System Power kW/COP-High Stage	2.73/2.30	3.06/2.30	4.38/2.30
HSPF (Btu/Watts-hr)	8.80	8.80	9.00
<b>Compressor</b>			
Number/Type	1/Scroll (2-stage)	1/Scroll (2-stage)	1/Scroll (2-stage)
<b>Sound</b>			
Outdoor Sound Rating (dB) <sup>(d)</sup>	81	87	87
<b>Outdoor Coil</b>			
Type	Lanced	Lanced	Lanced
Tube Size (in.)	0.3125	0.3125	0.3125
Face Area (sq. ft.)	12.33	17.00	17.00
Rows/FPI	3/16	3/16	3/16
Refrigerant Control	Thermal Expansion Valve	Thermal Expansion Valve	Thermal Expansion Valve
<b>Indoor Coil</b>			
Type	Lanced	Lanced	Lanced
Tube Size (in.)	0.3125	0.3125	0.3125
Face Area (sq. ft.)	8.74	9.27	9.27
Rows/FPI	3/16	3/16	3/16
Refrigerant Control	Thermal Expansion Valve	Thermal Expansion Valve	Thermal Expansion Valve
Drain Connection Number/Size (in.)	1¾ NPT	1¾ NPT	1¾ NPT
<b>Outdoor Fan</b>			
Type	Propeller	Propeller	Propeller
Number Used/Diameter (in.)	1/22	1/26	1/26
Drive Type/No. Speeds	Direct/1	Direct/1	Direct/1
cfm	3,600	5,130	5,130
Motor hp	0.25	0.40	0.40
Motor rpm	1,100	1,100	1,100

# Precedent 3-10 Ton Packaged Heat Pumps General Data

**Table 5. General data - 3 to 5 tons - high efficiency (continued)**

	3 Tons	4 Tons	5 Tons
	WHC036H3,4,W	WHC048H3,4,W	WHC060H3,4,W
<b>Indoor Fan</b>			
Type (Standard)	FC Centrifugal	FC Centrifugal	FC Centrifugal
Number Used/Diameter (in.)/Width (in.)	1/11x11	1/11x11	1/11x11
Drive Type/No. Speeds/rpm	Direct/Variable	Direct/Variable	Direct/Variable
Motor hp (standard/oversized)	0.75/1.5	1.0/1.5	1.0/1.5
Motor Frame Size (standard/oversized)	48/48	48/48	48/48
<b>Filters(e)</b>			
Type Furnished	Throwaway	Throwaway	Throwaway
Number Size Recommended	(2) 20x35x2	(4) 16x25x2	(4) 16x25x2
<b>Refrigerant Charge(f)</b>			
Pounds of R-410A	8.8	10.8	10.8

- (a) Cooling performance is rated at 95°F ambient, 80°F entering dry bulb, 67°F entering wet bulb. Gross capacity does not include the effect of fan motor heat. AHRI capacity is net and includes the effect of fan motor heat. Units are suitable for operation to ±20% of nominal cfm. Units are certified in accordance with the Unitary Air-Conditioner Equipment certification program, which is based on AHRI Standard 210/240.
- (b) EER and/or SEER are rated at AHRI conditions and in accordance with DOE test procedures.
- (c) Heating performance is rated at 47°F ambient with 43°F wet bulb, 70°F entering dry bulb, 60°F entering wet bulb. High temp. Btuh rating includes the effect of fan motor heat. Units are suitable for operation to ±20% of nominal cfm. Units are certified in accordance with the Unitary Air-Conditioner Equipment certification program, which is based on AHRI Standard 210/240.
- (d) Outdoor sound rating shown is tested in accordance with AHRI Standard 270. For additional information reference the outdoor sound power level data in the performance section.
- (e) Optional 2" MERV 8 and MERV 13 filters also available.
- (f) Refrigerant charge is an approximate value. For a more precise value, see unit nameplate and service instructions.

**Table 6. General data - 6 to 10 tons - high efficiency**

	6 Tons	7.5 Tons	8.5 Tons	10 Tons
	WHC074H3,4,W	WHC092H3,4,W	WHC102H3,4,W	WHC120H3,4,W
<b>Cooling Performance(a)</b>				
Gross Cooling Capacity - High Stage	78,900	96,200	105,900	123,600
EER(b)	12.1	11.8	3,4 = 12.0 / W = 11.8	11.5
Nominal CFM-High Stage / ARI Rated CFM	2,400 / 2,400	3,000 / 3,000	3,400 / 3,400	4,000 / 4,000
Nominal CFM-Low Stage / ARI Rated CFM	1,560	1,950	2,210	2,600
ARI Net Cooling Capacity - High Stage	78,000	95,000	104,000	121,000
IEER(c)	15.5(d)	15.5(d)	15.5(d)	15.5(d)
System Power - High Stage (kW)	6.45	8.05	8.67	10.52
<b>Heating Performance(e)</b>				
High Temp. Btuh Rating - High Stage	75,000	87,000	93,000	118,000
System Power kW/COP - High Stage	6.28 / 3,4 = 3.50 6.32 / W = 3.48	7.29 / 3,4 = 3.50 7.33 / W = 3.48	7.51 / 3,4 = 3.63 7.55 / W = 3.61	9.53 / 3,4 = 3.63 9.58 / W = 3.61
Low Temp. Btuh Rating - High Stage	40,000	49,000	57,000	61,000
System Power kW/COP - High Stage	5.21 / 2.25	6.38 / 2.25	7.42 / 2.25	7.95 / 2.25
<b>Compressor</b>				
Number/Type	2 / Scroll	2 / Scroll	2 / Scroll	2 / Scroll
<b>Sound</b>				
Outdoor Sound Rating (dB)(f)	86	86	85	85

# Precedent 3-10 Ton Packaged Heat Pumps General Data

**Table 6. General data - 6 to 10 tons - high efficiency (continued)**

	<b>6 Tons</b>	<b>7.5 Tons</b>	<b>8.5 Tons</b>	<b>10 Tons</b>
	<b>WHC074H3,4,W</b>	<b>WHC092H3,4,W</b>	<b>WHC102H3,4,W</b>	<b>WHC120H3,4,W</b>
<b>Outdoor Coil - Type</b>	Lanced	Lanced	Lanced	Lanced
Configuration	Full Face	Full Face	Full Face	Full Face
Tube Size (in.)	0.3125	0.3125	0.3125	0.3125
Face Area (sq. ft.)	19.83	19.83	23.34	25.56
Rows/FPI	3 / 16	3 / 16	3 / 16	4 / 16
Refrigerant Control	Thermal Expansion Valve	Thermal Expansion Valve	Thermal Expansion Valve	Thermal Expansion Valve
<b>Indoor Coil - Type</b>	Lanced	Lanced	Lanced	Lanced
Configuration	Full Face	Full Face	Full Face	Full Face
Tube Size (in.)	0.3125	0.3125	0.3125	0.3125
Face Area (sq. ft.)	12.36	12.36	12.36	16.59
Rows/FPI	3 / 16	3 / 16	4 / 16	4 / 16
Refrigerant Control	Thermal Expansion Valve	Thermal Expansion Valve	Thermal Expansion Valve	Thermal Expansion Valve
Drain Connection Number/Size (in.)	1¾ NPT	1¾ NPT	1¾ NPT	1¾ NPT
<b>Outdoor Fan - Type</b>	Propeller	Propeller	Propeller	Propeller
Number Used/Diameter (in.)	1 / 26	1 / 26	1 / 26	1 / 30
Drive Type/No. Speeds	Direct / 1	Direct / 1	Direct / 1	Direct / 1
cfm	6200	6200	6200	6900
Motor hp	0.70	0.70	0.70	0.75
Motor rpm	1,100	1,100	1,100	1,100
<b>Indoor Fan - Type (Standard)</b>	BC Plenum	BC Plenum	BC Plenum	BC Plenum
Number Used/Diameter (in.)/Width (in.)	1 / 19.7x15	1 / 19.7x15	1 / 19.7x15	1 / 19.7x15
Drive Type/No. Speeds/rpm	Direct/Variable <sup>(g)</sup>	Direct/Variable <sup>(g)</sup>	Direct/Variable <sup>(g)</sup>	Direct/Variable <sup>(g)</sup>
Motor hp (Standard/Oversized)	2.75 / -	2.75 / -	2.75 / -	2.75 / -
Motor Frame Size (Standard/Oversized)	- / -	- / -	- / -	- / -
<b>Filters<sup>(h)</sup> - Type Furnished</b>	Throwaway	Throwaway	Throwaway	Throwaway
Number Size Recommended	(4) 20x25x2	(4) 20x25x2	(4) 20x25x2	(3) 20x25x2 (2) 20x30x2
<b>Refrigerant Charge<sup>(i)</sup></b>				
Pounds of R-410A	14.5	14.2	17.0	23.9

- (a) Cooling performance is rated at 95°F ambient, 80°F entering dry bulb, 67°F entering wet bulb. Gross capacity does not include the effect of fan motor heat. AHRI capacity is net and includes the effect of fan motor heat. Units are suitable for operation to ±20% of nominal cfm. Units are certified in accordance with the Unitary Air-Conditioner Equipment certification program, which is based on ARI Standard 340/360.
- (b) EER and/or SEER are rated at AHRI conditions and in accordance with DOE test procedures.
- (c) Integrated Efficiency Ratio (IEER) is rated in accordance with AHRI Standard 340/360. The IEER rating requires that the unit efficiency be determined at 100%, 75%, 50% and 25% load (net capacity) at the specified in AHRI Standard.
- (d) 16.5 IEER for SZ/MZVAV option, 16.0 IEER for Title24 2 speed fan option.
- (e) Heating performance is rated at 47°F ambient with 43°F wet bulb, 70°F entering dry bulb, 60°F entering wet bulb. High temp. Btu/h Rating includes the effect of fan motor heat. Units are suitable for operation to ±20% of nominal cfm. Units are certified in accordance with the Unitary Air-Conditioner Equipment certification program, which is based on AHRI Standard 340/360.
- (f) Outdoor sound rating shown is tested in accordance with AHRI Standard 270-2015. For additional information reference the outdoor sound power level data in the performance section.
- (g) For multispeed direct drive rpm values, reference the direct drive, evaporator fan performance tables.
- (h) Optional 2" MERV 8 and MERV 13 filters also available.
- (i) Refrigerant charge is an approximate value. For a more precise value, see unit nameplate and service instructions.

# Precedent 3-10 Ton Packaged Heat Pumps General Data

**Table 7. General data - 3 to 5 tons - dual fuel efficiency**

	<b>3 Tons</b>	<b>4 Tons</b>	<b>5 Tons</b>
	<b>DHC036H3,4,W</b>	<b>DHC048H3,4,W</b>	<b>DHC060H3,4,W</b>
<b>Cooling Performance<sup>(a)</sup></b>			
Gross Cooling Capacity-High Stage	36,400	48,750	61,000
EER/SEER <sup>(b)</sup>	3=12.5/15.7 4,W=12.5/15.6	13.0/16.5	3=12.8/16.2 4,W=12.8/16.0
Nominal cfm-High Stage/AHRI Rated cfm	1,200/1,200	1,600/1,680	2,000/2,000
Nominal cfm-Low Stage/AHRI Rated cfm	840	1,120	1,400
AHRI Net Cooling Capacity-High Stage	36,000	48,000	60,000
System Power-High Stage (kW)	2.88	3.69	4.69
<b>Heating Performance<sup>(c)</sup></b>			
High Temp. Btuh Rating-High Stage	32,200	44,000	57,000
System Power kW/COP-High Stage	2.62/3.60	3.58/3.60	4.64/3.60
Low Temp. Btuh Rating-High Stage	21,400	24,000	34,400
System Power kW/COP-High Stage	2.73/2.30	3.06/2.30	4.38/2.30
HSPF (Btu/Watts-hr)	8.80	8.80	8.90
<b>Compressor</b>			
Number/Type	1/Scroll (2-stage)	1/Scroll (2-stage)	1/Scroll (2-stage)
<b>Sound</b>			
Outdoor Sound Rating (dB) <sup>(d)</sup>	81	87	87
<b>Outdoor Coil</b>			
Type	Lanced	Lanced	Lanced
Tube Size (in.)	0.3125	0.3125	0.3125
Face Area (sq. ft.)	12.33	17.00	17.00
Rows/FPI	3/16	3/16	3/16
Refrigerant Control	Thermal Expansion Valve	Thermal Expansion Valve	Thermal Expansion Valve
<b>Indoor Coil</b>			
Type	Lanced	Lanced	Lanced
Tube Size (in.)	0.3125	0.3125	0.3125
Face Area (sq. ft.)	8.74	9.27	9.27
Rows/FPI	3/16	3/16	3/16
Refrigerant Control	Thermal Expansion Valve	Thermal Expansion Valve	Thermal Expansion Valve
Drain Connection Number/Size (in.)	1¾ NPT	1¾ NPT	1¾ NPT
<b>Outdoor Fan</b>			
Type	Propeller	Propeller	Propeller
Number Used/Diameter (in.)	1/22	1/26	1/26
Drive Type/No. Speeds	Direct/1	Direct/1	Direct/1
cfm	3,600	5,130	5,130
Motor hp	0.25	0.40	0.40
Motor rpm	1,100	1,100	1,100
<b>Indoor Fan</b>			
Type (Standard)	FC Centrifugal	FC Centrifugal	FC Centrifugal
Number Used/Diameter (in.)/Width (in.)	1/11x11	1/11x11	1/11x11
Drive Type/No. Speeds/rpm	Direct/Variable	Direct/Variable	Direct/Variable
Motor hp (standard)	0.75	1.0	1.0



# Precedent 3-10 Ton Packaged Heat Pumps General Data

**Table 7. General data - 3 to 5 tons - dual fuel efficiency (continued)**

	3 Tons	4 Tons	5 Tons
	DHC036H3,4,W	DHC048H3,4,W	DHC060H3,4,W
Motor Frame Size (standard)	48	48	48
<b>Filters(e)</b>			
Type Furnished	Throwaway	Throwaway	Throwaway
Number Size Recommended	(2) 20x35x2	(4) 16x25x2	(4) 16x25x2
<b>Refrigerant Charge(f)</b>			
Pounds of R-410A	8.8	10.8	10.8
<b>Gas Heating Performance (Dual Fuel Only)(g)</b>			
<b>Gas Heating Input (2nd stage/1st stage)</b>			
Low Heat Input (Btu)	60,000/42,000	60,000/42,000	60,000/42,000
Mid Heat Input (Btu)	80,000/56,000	100,000/70,000	100,000/72,000
High Heat Input (Btu)	100,000/70,000	130,000/91,000	150,000/105,000
<b>Gas Heating Output (2nd stage/1st stage)</b>			
Low Heat Output (Btu)	48,600/34,020	48,600/34,020	48,600/34,020
Mid Heat Output (Btu)	64,800/45,360	81,000/56,700	81,000/58,320
High Heat Output (Btu)	81,000/56,700	105,300/73,710	121,500/85,050
<b>Steady State Efficiency %</b>	81%	81%	81%
<b>No. Burners</b>			
Low Heat Output (Btu)	2	2	2
Mid Heat Output (Btu)	2	3	3
High Heat Output (Btu)	3	3	4
<b>No. Stages</b>			
Low Heat Input (Btu)	2	2	2
Mid Heat Input (Btu)	2	2	2
High Heat Input (Btu)	2	2	2
<b>Gas Supply Line Pressure</b>			
Natural (minimum/maximum)	4.5/14.0	4.5/14.0	4.5/14.0
LP (minimum/maximum)	N/A	N/A	N/A
<b>Gas Connection Pipe Size (in.)</b>			
Low Heat	1/2	1/2	1/2
Mid Heat	1/2	1/2	1/2
High Heat	1/2	3/4	3/4

- (a) Cooling performance is rated at 95°F ambient, 80°F entering dry bulb, 67°F entering wet bulb. Gross capacity does not include the effect of fan motor heat. AHRI capacity is net and includes the effect of fan motor heat. Units are suitable for operation to ±20% of nominal cfm. Units are certified in accordance with the Unitary Air-Conditioner Equipment certification program, which is based on AHRI Standard 210/240.
- (b) EER and/or SEER are rated at AHRI conditions and in accordance with DOE test procedures.
- (c) Heating performance is rated at 47°F ambient with 43°F wet bulb, 70°F entering dry bulb, 60°F entering wet bulb. High temp. Btu/h rating includes the effect of fan motor heat. Units are suitable for operation to ±20% of nominal cfm. Units are certified in accordance with the Unitary Air-Conditioner Equipment certification program, which is based on AHRI Standard 210/240.
- (d) Outdoor sound rating shown is tested in accordance with AHRI Standard 270. For additional information reference the outdoor sound power level data in the performance section.
- (e) Optional 2" MERV 8 and MERV 13 filters also available.
- (f) Refrigerant charge is an approximate value. For a more precise value, see unit nameplate and service instructions.
- (g) Heating performance limit settings and rating data were established and approved under laboratory test conditions using American National Standards Institute standards. Ratings shown are for elevations up to 2000 feet. For elevations above 2000 feet, ratings should be reduced at the rate of 4% for each 1000 feet above sea level. Applicable to dual fuel units only.

# Precedent 3-10 Ton Packaged Heat Pumps General Data

**Table 8. General data - 6 to 10 tons - dual fuel efficiency**

	<b>6 Tons</b>	<b>7.5 Tons</b>	<b>8.5 Tons</b>	<b>10 Tons</b>
	<b>DHC074H3,4,W</b>	<b>DHC092H3,4,W</b>	<b>DHC102H3,4,W</b>	<b>DHC120H3,4,W</b>
<b>Cooling Performance<sup>(a)</sup></b>				
Gross Cooling Capacity - High Stage	78,900	96,200	105,900	123,600
EER <sup>(b)</sup>	12.1	11.8	3,4 = 12.0 / W = 11.8	11.5
Nominal CFM-High Stage / ARI Rated CFM	2,400 / 2,400	3,000 / 3,000	3,400 / 3,400	4,000 / 4,000
Nominal CFM-Low Stage / ARI Rated CFM	1,560	1,950	2,210	2,600
ARI Net Cooling Capacity - High Stage	78,000	95,000	104,000	121,000
IEER <sup>(c)</sup>	15.5 <sup>(d)</sup>	15.5 <sup>(d)</sup>	15.5 <sup>(d)</sup>	15.5 <sup>(d)</sup>
System Power - High Stage (kW)	6.45	8.05	8.67	10.52
<b>Heating Performance<sup>(e)</sup></b>				
High Temp. Btuh Rating - High Stage	75,000	87,000	93,000	118,000
System Power kW/COP - High Stage	6.28 / 3,4 = 3.50 6.32 / W = 3.48	7.29 / 3,4 = 3.50 7.33 / W = 3.48	7.51 / 3,4 = 3.63 7.55 / W = 3.61	9.53 / 3,4 = 3.63 9.58 / W = 3.61
Low Temp. Btuh Rating - High Stage	40,000	49,000	57,000	61,000
System Power kW/COP - High Stage	5.21 / 2.25	6.38 / 2.25	7.42 / 2.25	7.95 / 2.25
<b>Compressor</b>				
Number/Type	2 / Scroll	2 / Scroll	2 / Scroll	2 / Scroll
<b>Sound</b>				
Outdoor Sound Rating (dB) <sup>(f)</sup>	86	86	85	85
<b>Outdoor Coil - Type</b>				
Configuration	Lanced	Lanced	Lanced	Lanced
Tube Size (in.)	0.3125	0.3125	0.3125	0.3125
Face Area (sq. ft.)	19.83	19.83	23.34	25.56
Rows/FPI	3 / 16	3 / 16	3 / 16	4 / 16
Refrigerant Control	Thermal Expansion Valve	Thermal Expansion Valve	Thermal Expansion Valve	Thermal Expansion Valve
<b>Indoor Coil - Type</b>				
Configuration	Lanced	Lanced	Lanced	Lanced
Tube Size (in.)	0.3125	0.3125	0.3125	0.3125
Face Area (sq. ft.)	12.36	12.36	12.36	16.59
Rows/FPI	3 / 16	3 / 16	4 / 16	4 / 16
Refrigerant Control	Thermal Expansion Valve	Thermal Expansion Valve	Thermal Expansion Valve	Thermal Expansion Valve
Drain Connection Number/Size (in.)	1¾ NPT	1¾ NPT	1¾ NPT	1¾ NPT
<b>Outdoor Fan - Type</b>				
Number Used/Diameter (in.)	Propeller	Propeller	Propeller	Propeller
Drive Type/No. Speeds	1 / 26	1 / 26	1 / 26	1 / 30
cfm	Direct / 1	Direct / 1	Direct / 1	Direct / 1
Motor hp	6200	6200	6200	6900
Motor rpm	0.70	0.70	0.70	0.75
	1,100	1,100	1,100	1,100
<b>Indoor Fan - Type (Standard)</b>				
Number Used/Diameter (in.)/Width (in.)	BC Plenum	BC Plenum	BC Plenum	BC Plenum
Drive Type/No. Speeds/rpm	1 / 19.7x15	1 / 19.7x15	1 / 19.7x15	1 / 19.7x15
Motor hp (Standard/Oversized)	Direct/Variable <sup>(g)</sup>	Direct/Variable <sup>(g)</sup>	Direct/Variable <sup>(g)</sup>	Direct/Variable <sup>(g)</sup>
Motor Frame Size (Standard/Oversized)	2.75 / -	2.75 / -	2.75 / -	2.75 / -
	- / -	- / -	- / -	- / -

# Light Commercial Voyager Packaged Systems

---

Features and Benefits ..... LVOY-2

## **Packaged Gas / Electric**

Application Considerations ..... LVOY-18

Selection Procedure ..... LVOY-20

Model Number Description ..... LVOY-22

General Data ..... LVOY-24

## **Packaged Heat Pumps**

Application Considerations ..... LVOY-36

Selection Procedure ..... LVOY-37

Model Number Description ..... LVOY-39

General Data ..... LVOY-41

# Voyager 2 Packaged Systems Features and Benefits

**Note:** Packaged Rooftop units cooling, heating capacities, and efficiencies are AHRI certified within scope of AHRI Standard 340-360 (I-P) and ANSI Z21.47 and 10 CFR Part 431 pertaining to Commercial Warm Air Furnaces (gas heating units).

## Standard Features and Available Options

**Table 1. Voyager™ Light Commercial control features – standard and optional**

	Standard Features	Options <sup>(a)</sup>		
		Factory Installed	Factory or Field Installed	Field Installed
BACnet® Communications Interface (BCI)			X	
Discharge Line Thermostat	X			
Humidity Sensor				X
LonTalk® Communications Interface (LCI)			X	
ReliaTel™ Microprocessor Controls	X			
ReliaTel™ Options Module			X	
Thermostat				X
American Standard® Air-Fi® Wireless Communication Interface		X		
American Standard® Communications Interface (TCI)			X	
Wireless Zone Sensor				X
Zone Sensors and Remote Zone Sensors				X

(a) Refer to model number description for option availability

**Table 2. Voyager™ Light Commercial features - standard and optional**

	Standard Features	Options <sup>(a)</sup>		
		Factory Installed	Factory or Field Installed	Field Installed
1-year Limited Parts Warranty	X			
5-year Limited Compressor Warranty	X			
5-year Limited Heat Exchanger Warranty (12½–17½ Tons); 1 Year on 20 and 25 Tons	X			
2-in MERV 8 Filters or 2-in MERV 13 Filters with Filter Removal Tool		X		
2-in throwaway filters	X			
3 Stages of Cooling Capability on 12½–20 Tons, 4 Stages of Cooling Capability on 25 Tons (High Efficiency Units Only)	X			
Anti-Short Cycle Timer	X			
Barometric Relief <sup>(b)</sup>	X			
Belt Drive Motors	X			
Clogged Filter/Fan Failure Switch			X	
CO <sub>2</sub> Sensor				X
CO <sub>2</sub> Sensor Wiring (Wiring Only)		X		
Colored and Numbered Wiring	X			
Complete Coat™ Microchannel Condenser Coil		X		
Condensate Overflow Switch		X		
Crankcase Heaters	X			
Dedicated Airflow	X			

# Voyager 2 Packaged Systems Features and Benefits

**Table 2. Voyager™ Light Commercial features - standard and optional (continued)**

	Standard Features	Options <sup>(a)</sup>		
		Factory Installed	Factory or Field Installed	Field Installed
Dehumidification (Hot Gas Reheat)		X		
Digital Display Zone Sensor				X
Discharge Air Temperature Sensing Kit			X	
Easy Access Low Voltage Terminal Board (LTB)	X			
Economizer - Standard, Downflow			X	
Economizer - Standard, Horizontal				X
Electric Heaters			X	
Fault Detection and Diagnostics (FDD)		X		
Foil-Faced and Edge Captured Insulation	X			
Frostat™			X	
High and Low Static Drive Kits				X
High Efficiency Drum and Tube Heat Exchanger	X			
High Efficiency Gas Heat with Hot Surface Ignition	X			
High Efficiency Motors		X		
High Pressure Cutout	X			
High Short Circuit Current Rated (SCCR) Electrical Subsystem		X		
Hinged Access Doors		X		
Human Interface - 5 inch Color Touchscreen		X		
IAQ Sloped Condensate Drain Pan	X			
Indoor Fan Motor Shaft Grounding Ring			X	
Liquid Line Refrigerant Drier	X			
Low Ambient Cooling to 0°F	X			
Low Leak Economizer - Downflow			X	
Low Leak Economizer - Downflow and Horizontal				X
LP Conversion Kit				X
Manual Outside Air Dampers				X
Microchannel Type Condenser Coils	X			
Microchannel Type Evaporator Coils (Standard Efficiency Only)	X			
Modulating Gas Heat Furnace with a 2.5:1 Turndown Ratio		X		
Motorized Outside Air Dampers				X
Multi-Speed Indoor Fans		X		
Multiple Zone Variable Air Volume (MZVAV)		X		
Operating Charge of R-410A	X			
Outside Air Measuring/Monitoring Control (TraQ Dampers)				X
Oversized Motors			X	
Phase Monitor	X			
Powered Exhaust				X
Powered or Unpowered Convenience Outlet		X		
Provisions for Through-the-Base Gas Connections	X			
Quick Access Panels	X			
Quick Adjust Idler Arm Pulley	X			
Reference or Comparative Enthalpy			X	

# Voyager 2 Packaged Systems Features and Benefits

**Table 2. Voyager™ Light Commercial features - standard and optional (continued)**

	Standard Features	Options <sup>(a)</sup>		
		Factory Installed	Factory or Field Installed	Field Installed
Remote Potentiometer				X
Roof Curb (Downflow Only)				X
Single Point Power	X			
Single Side Service	X			
Single Zone Variable Air Volume (SZ VAV)		X		
Stainless Steel Drain Pan		X		
Stainless Steel Heat Exchanger with 10 Year Warranty		X		
Standardized Components	X			
Supply and/or Return Air Smoke Detector		X		
Thermal Expansion Valve	X			
Through the Base Electrical Access		X		
Through the Base Electrical with Circuit Breaker		X		
Through the Base Electrical with Disconnect Switch		X		
Through the Base Gas Piping		X		
Tool-less Hail Guards			X	
U-shaped Airflow Pattern	X			
Variable Frequency Drive (Multispeed Indoor Fan, VAV, and Single Zone VAV)	X			
Ventilation Override Accessory				X

(a) Refer to model number description for option availability.  
(b) Barometric relief comes standard with economizers.

**Note:** Most Factory Installed Options (FIOPS) available for Downflow Air Discharge units only. Please verify with ordering system for availability.

## Standard Features

### Anti-Short Cycle Timer

Provides a 3 minute minimum "ON" time and 3 minute "OFF" time for compressors to enhance compressor reliability by assuring proper oil return.

### Barometric Relief

Designed to be used on downflow units, barometric relief is an unpowered means of relieving excess building pressure.

### Colored and Numbered Wiring

Save time and money tracing wires and diagnosing the unit.

# Voyager 2 Packaged Systems Features and Benefits

## Compressors

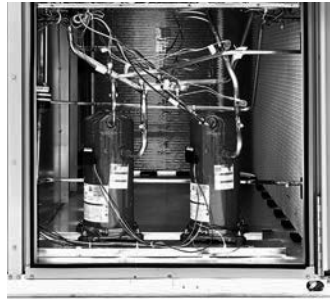

Voyager contains the best compressor technology available to achieve the highest possible performance. Dual compressors are outstanding for humidity control, light load cooling conditions and system back-up applications. Dual compressors are available on all models and allow for efficient cooling utilizing three stages of compressor operation (high efficiency 12½–20 Tons models only). 25 tons high efficiency units have 4 stages of cooling with a single compressor and tandem set (similar to variable speed).

## Controls—ReliaTel™

ReliaTel microprocessor controls provide unit control for heating, cooling and ventilating utilizing input from sensors that measure indoor and outdoor temperature and other zone sensors. ReliaTel also provides outputs for building automation systems and expanded diagnostics. For a complete list of ReliaTel offerings, refer to “Other Benefits,” p. 17.

## Conversionless Units

The dedicated design units (either downflow or horizontal) require no panel removal or alteration time to convert in the field — a major cost savings during installation. Horizontal units come complete with duct flanges so the contractor doesn't have to field fabricate them. These duct flanges are a time and cost saver.

## Crankcase Heaters

These band or insertion heaters provide improved compressor reliability by warming the oil to prevent migration during off-cycles or low ambient conditions. These are standard on all Voyager models.

## Discharge Line Thermostat

A bi-metal element discharge line thermostats installed as a standard feature on the discharge line of each system. This standard feature provides extra protection to the compressors against high discharge temperatures in case of loss of charge, extremely high ambient and other conditions which could drive the discharge temperature higher.

## Efficiencies

Standard or High Efficiency Cooling available.

## Easy Access Low Voltage Terminal Board



## Foil Faced Insulation



# Voyager 2 Packaged Systems Features and Benefits

Voyager's Low Voltage Terminal Board is external to the electrical control cabinet. It is extremely easy to locate and attach the thermostat wire and test operation of all unit functions. This is another cost and time saving installation feature.

## Fork Pocket Access

Voyager™ has the ability to be forked from 3 sides.

## Heat Exchanger—Drum and Tube

The cabinet features a drum and tube heat exchanger (pictured right) that is manufactured using aluminized steel with stainless steel components for maximum durability.

The requirement for cycle testing of heat exchangers is 10,000 cycles by ANSI Z21.47. This is the standard required by both UL and AGA for cycle test requirements.

American Standard requires the design to be tested to 2½ times this current standard. The drum and tube design has been tested and passed over 150,000 cycles, which is over 15 times the current ANSI cycling requirements. The negative pressure gas valve is used in the standard furnaces. This is one of our unique safety features. Modulating heaters use a pressure switch to ensure that the blower motor is operating before the gas valve is allowed to open.

The forced combustion blower supplies pre-mixed fuel through a single stainless steel burner screen into a sealed drum where ignition takes place. It is more reliable to operate and maintain than a multiple burner system. Modulating furnaces contain a metal fiber material to ensure proper flame distribution at low fire. The hot surface ignitor is a gas ignition device which doubles as a safety device utilizing a continuous test to prove the flame. The design is cycle tested at the factory for quality and reliability. Our gas/electric rooftops exceed all California seasonal efficiency requirements and perform even better than the California NO<sub>x</sub> emission requirements.

## Low Ambient Cooling

All Voyager microprocessor units have cooling capabilities down to 0°F as standard.

## Low Voltage Connections

The wiring of the low voltage connections to the unit and the zone sensors is as simple as 1-1, 2-2, and 3-3. This simplified system makes it easy for the installer to wire.

All panels in the evaporator section of the unit have cleanable foil-faced insulation. All edges are either captured or sealed to ensure no insulation fibers get into the airstream.

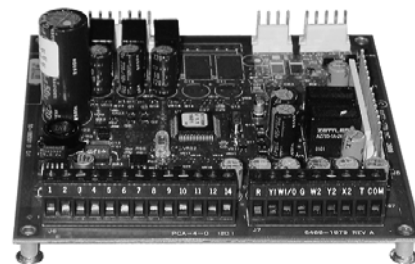
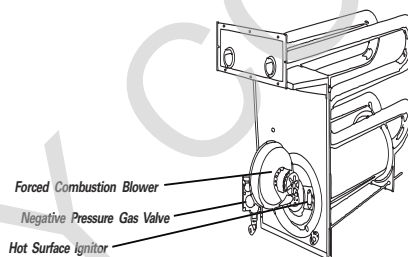



# Voyager 2 Packaged Systems Features and Benefits

## Microchannel Coils

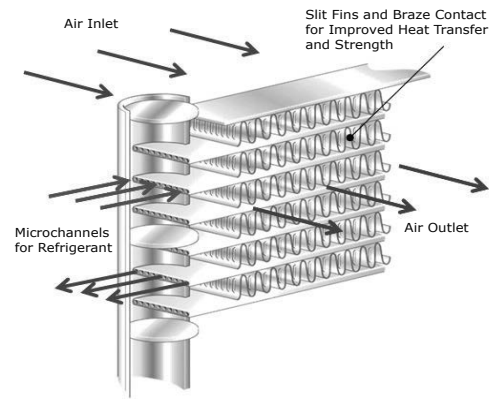

Microchannel coils are all-aluminum coils with fully-brazed construction. This design reduces risk of leaks and provides increased coil rigidity — making them more rugged on the jobsite. Their flat streamlined tubes with small ports and metallurgical tube-to-fin bond allow for exceptional heat transfer.

Microchannel all-aluminum construction provides several additional benefits:

- Light weight (simplifies coil handling)
- Easy to recycle
- Minimize galvanic corrosion

## Motors

All indoor fan motors are belt drive as standard.

## Pressure Cutouts

Low and high pressure cutouts are standard on all Voyager models.

## Phase Monitor

Voyager features a three-phase line monitor module that protects against phase loss, phase reversal and phase unbalance. It is intended to protect compressors from reverse rotation. It has an operating input voltage range of 190–600 Vac, and LED indicators for ON and FAULT. There are no field adjustments and the module will automatically reset from a fault condition.

## Quick-Access Panels

Remove three or more screws for access to the standardized internal components and wiring.

## Quick-Adjust Slider Plate

With the Quick-Adjust Slider Plate (pictured right), the belt and sheaves can be quickly adjusted without moving the mounted fan motor. The result is a major savings in time and money.

## Single Point Power

A single electrical connection powers the unit.

## Single Side Service

Single side service is standard on all units.



## Sloped Drain Pans

Every Voyager unit has a non-corrosive, sloped drain pan made of pre-painted steel and standard on all units.

## Standardized Components

Components are placed in the same location on all Voyager units. Familiarize yourself with one Voyager and you are familiar with every Voyager. Due to standardized components throughout the Voyager line, contractors/owners can stock fewer parts.

# Voyager 2 Packaged Systems Features and Benefits

---

## U-Shaped Airflow Pattern

The U-shaped airflow allows for improved static capabilities.

## Variable Frequency Drives - VFD (Multispeed Indoor Fan, VAV, and SZ VAV Only)

Variable Frequency Drives are factory installed and tested to provide supply fan motor speed modulation. VFDs on the supply fan, as compared to inlet guide vanes or discharge dampers, are quieter, more efficient, and are eligible for utility rebates. All VFDs are designed to allow bypass if required. Bypass control will simply provide full nominal airflow in the event of drive failure. Bypass mode is indicated in the unit wiring manual. Modulating gas heat models with SZVAV allow tighter space temperature control with less temperature swing.

## Variety of Options<sup>1</sup>

### Factory Installed Options

#### American Standard® Air-Fi® Wireless

American Standard® Air-Fi® wireless communication is a reliable, flexible solution that frees you from the hassles associated with wired components for your building controls system. With Air-Fi® wireless, you get easy problem solving, efficient performance, and cost savings over the life of the equipment.

#### CO<sub>2</sub> Sensor Wiring

This is the unit wiring for field installed CO<sub>2</sub> sensors. Factory-installed CO<sub>2</sub> sensor wiring saves time and ensures proper unit connections for the field installed CO<sub>2</sub> sensor kits.

#### Complete Coat™ Condenser Coil

The cathodic epoxy type electrodisposition coating is formulated for high edge build to a number of different types of heat exchangers. The coating is selected to provide excellent resistance and durability to corrosive effects of alkalies, acids, alcohols, petroleum, seawater, salt air, and corrosive environments. This coating is available for microchannel coils only.

#### Circuit Breaker (Required with Through-the-Base Electrical)

This option is a factory installed thermal magnetic, molded case, HACR Circuit Breaker with provisions for through the base electrical connections. Available on all models.

#### Condensate Overflow Switch

A condensate overflow switch is available to shut the unit down in the event that the condensate drain line becomes clogged. This option protects the unit from water overflowing from the drain pan and entering the base of the units.

#### Dehumidification (Hot Gas Reheat)

This option allows for increased outdoor air ventilation. It reduces humidity levels while increasing comfort level in the air space. Cooling can operate without a demand for dehumidification. The hot gas reheat coil is designed to deliver maximum reheat temperature.

<sup>1</sup> Refer to "Model Number Description," p. 24 for option availability.

# Voyager 2 Packaged Systems Features and Benefits

## Disconnect Switch (Required with Through-the-Base Electrical)



Factory installed 3-pole, molded case, disconnect switch with provisions for through the base electrical connections are available. Available on all models. Codes require a method of assured unit shutdown for servicing. Field-installed disconnects sometimes interfere with service access. Factory installation of unit disconnects reduces costs, assures proper mounting and provides the opportunity to upgrade to unit circuit breaker protection.

## Fault Detection and Diagnostics (FDD)

This offering meets the mandatory requirement of CA Title 24 of fully configurable diagnostics allowing fault history and reading fault codes at the unit. This option provides detection of the following faults: Air temperature sensor failure/fault and notification of acceptable economizer mode. The FDD system shall be certified by the Energy Commission as meeting the requirements.

## High Efficiency Filtration

Voyager units offer a variety of high efficiency filtration options. MERV 8 and MERV 13 filters provide additional filtration beyond the capabilities of typical 2-inch throwaway filters. Also, when MERV 8 or MERV 13 filters are ordered, units come equipped with a filter removal tool.

## High Efficiency Motors

High efficiency motors are available with efficiency ratings from 86.5 up to 91.0. It is not available for all models.

## High Short Circuit Current Rating (SCCR)

Voyager rooftop units now have an optional high short circuit current rated electrical subsystem for units with an MOP above 60A. This option is a perfect fit for applications that need protection against high potential fault currents. This option also includes individual over current protection for each compressor and the indoor fan, as well as a dedicated over current protection to the condenser fan motor(s). When the high SCCR is ordered, the control box will have components separated into two sections - high and low voltage components.

## Hinged Access Doors



These doors permit easy access to the filter, fan/heat, and compressor/control sections. They reduce the potential roof damage from screws or sharp access door corners.

# Voyager 2 Packaged Systems Features and Benefits

## Human Interface

The 5 inch Color Touchscreen Human Interface provides an intuitive user interface to the rooftop unit that speeds up unit commissioning, shortens unit troubleshooting times, and enhances preventative maintenance measures. The human interface includes several features such as:

- Data trending capabilities by means of time series graphs
- Historical alarm messages
- Real-time sensor measurements
- On board system setpoints
- USB port that enables the downloading of component runtime information as well as trended historical sensor data
- Customizable reports



## Modulating Gas Heat with a 2.5:1 Turndown Ratio

Upon receiving a call for heat, modulating gas heat units with a 2.5:1 turndown ratio light their burner at full fire (100%). After the burner is lit, the unit controls will monitor the discharge air temperature and modulate the input rate down to match the load.

**Note:** *Modulating gas heat units are equipped with a stainless steel heat exchanger as standard.*

## Multi-Speed Indoor Fan System

Multi-speed indoor fan system is designed for use in applications for meeting the minimum requirement of CA Title 24. This system incorporates a multi-speed fan control to change the speed of the fan to 66% of full airflow based off compressor stages.

## Multiple-Zone VAV Control

A multiple-zone VAV (MZVAV) system consists of a packaged rooftop unit that serves several individually controlled zones. Each zone is equipped with a VAV terminal unit that varies the quantity of air delivered to maintain the desired temperature in that zone. The rooftop unit controller varies the speed of the indoor fan to maintain the static pressure in the supply ductwork at a setpoint, ensuring that all zones receive the necessary quantity of air. In addition, cooling capacity is cycled to maintain the supply air temperature at the desired setpoint.

For decades, American Standard has been an industry leader in rooftop VAV systems. Now, multiple-zone VAV control is available in American Standard's light commercial rooftop platform (3-25 tons).

## Novar Unit Controls

Novar 3051 and 2024 are available for Voyager Cooling and Gas/Electric models.

## Powered or Unpowered Convenience Outlet

This option is a GFCI, 120V/15amp, 2-plug, convenience outlet, either powered or unpowered. This option can only be ordered when Through the Base Electrical with either the Disconnect Switch or Circuit Breaker option is ordered. This option is available on all models.

## Single Zone VAV - One Zone Variable Air Volume Mode

**Note:** *Single Zone VAV is designed to be used with a zone sensor. If a unit is configured for Single Zone VAV operation but is connected to a thermostat, the control will revert to multi-speed (2-Speed) indoor fan control. (See "Multi-Speed Indoor Fan System" above.)*

# Voyager 2 Packaged Systems Features and Benefits

Single zone VAV is designed for use in single zone applications like gymnasiums, auditoriums, manufacturing facilities, retail box stores, and any large open spaces, where there is a lot of diversity in the load profile. Single Zone VAV (SZ VAV) is an ideal replacement to "yesterday's" constant volume (CV) systems, by reducing operating costs while improving occupant comfort.

SZ VAV systems combine American Standard application, control and system integration knowledge to exactly match fan speed with cooling and heating loads, regardless of the operating condition. American Standard algorithms meet/exceed ASHRAE 90.1-2010, SZ VAV energy-saving recommendations, and those of CA Title 24. The result is an optimized balance between zone temperature control and system energy savings. Depending on your specific application, energy savings can be as much as 20%.

**Note:** Building system modeling in energy simulation software like TRACE is recommended to evaluate performance improvements for your application.

SZ VAV is fully integrated into the ReliaTel Control system and is available today. It provides the simplest and fastest commissioning in the industry through proven factory-installed, wired, and tested system controllers. All control modules, logic and sensors are factory installed, and tested to assure the highest quality and most reliable system available. This means no special programming of algorithms, or hunting at the jobsite for sensors, boards, etc. that need to be installed in the field. Single zone VAV is a quick and simple solution for many applications and is available from your most trusted rooftop VAV system solution provider- American Standard.

## Stainless Steel Drain Pan

For excellent corrosion and oxidation resistance, the optional stainless steel drain pan provides a cleanable surface that complement other IAQ solutions such as high efficiency filtration (MERV 8 or 13), demand control ventilation (CO<sub>2</sub>), and hot gas reheat.

## Stainless Steel Heat Exchanger

The optional stainless steel heat exchanger is constructed of 439 stainless steel. It is resistant to corrosion and oxidation and easy to clean. The high strength to weight ratio allows for high ventilation rates with gas units and comes standard with a modulating gas heat option. With this option, a 10-year stainless steel heat exchanger warranty is standard.

## Supply, Return, and Plenum Air Smoke Detector

With this option (pictured right) installed, if smoke is detected, all unit operation will be shut down. Reset will be manual at the unit. Return Air Smoke Detectors require minimum allowable airflow when used with certain models.

Supply and/or Return Smoke Detectors may not be used with the Plenum Smoke Detector.



## Through-the-Base Electrical Utility Access

An electrical service entrance shall be provided allowing electrical access for both control and main power connections inside the curb and through the base of the unit. Option will allow for field installation of liquid-tight conduit and an external field installed disconnect switch.

Factory provided through the base openings simplify wiring and piping. Because these utility openings frequently minimize the number of roof penetrations, the integrity of roofing materials is enhanced.

# Voyager 2 Packaged Systems Features and Benefits

## Through-the-Base Gas Piping (Gas/Electric Only)

This option (pictured right) shall have all piping necessary including, black steel, manual gas shut-off valve, elbows, and union. This assembly will require minor field labor to install.



## Factory or Field Installed Options<sup>1</sup>

### BACnet® Communications Interface

The BACnet® communications interface allows the unit to communicate directly with a generic open protocol BACnet® MS/TP Network Building Automation System Controls.

### Clogged Filter/Fan Failure Switch

A dedicated differential pressure switch is available to achieve active fan failure indication and/or clogged filter indication. These sensors allow a zone sensor service light or Integrated Comfort System to indicate a dirty filter or a fan that's not working. The field installation charges for these valuable feedback devices often eliminate them from consideration. Factory installation can make such features a good investment.

### Discharge Air Temperature Sensing Kit

Provides true discharge air temperature sensing in heating models. The kit is functional only with the ReliaTel Options Module.

### Economizer - Standard, Downflow

Economizers are equipped with either dry bulb, reference, or comparative enthalpy sensing. These economizers provide free cooling as the outdoor temperature and/or humidity decreases. Correctly installed, they offer a valuable energy savings. Factory-installed economizers save time and ensure proper installation.

**Note:** *Factory-installed economizers require some field set-up.*

### Economizer - Low Leak, Downflow

This accessory meets low leak requirements for ASHRAE 90.1, IECC, and CA Title 24 standards (3 cfm/ft<sup>2</sup>@1" wg exterior air, 4 cfm/ft<sup>2</sup>@1" wg return air). This option allows 100% outdoor air supply from 0-100% modulating dampers and is standard with barometric relief. It can be paired with powered exhaust for additional building pressure relief. This option can be paired with or without Fault Detection and Diagnostics (FDD) to meet current mandatory CA Title 24 requirements. Available on downflow units only. The economizers come with three control options, dry bulb and reference or comparative enthalpy (optional).

### Electric Heaters

Electric heat modules are available within the basic unit. If ordering the Through the Base Electrical option with an Electrical Heater, the heater must be factory installed.

### Frostat™

A capillary bulb embedded in the face of the evaporator coil or a thermostat on the suction line monitors coil temperature to prevent evaporator icing and protect the compressor. Recommended for applications with low leaving air temperatures, low airflow and/or high latent load applications.

**Note:** *Frostat is standard on all Single-Zone VAV, Multiple-Zone VAV, and high efficiency units.*

<sup>1</sup> Refer to "Model Number Description," p. 24 for option availability.

# Voyager 2 Packaged Systems Features and Benefits

## Indoor Fan Motor Shaft Grounding Ring

Shaft grounding rings are used on all VFD driven motors to provide a conductive discharge path away from the motor bearings to ground. Bearing Protection Rings shall be maintenance free circumferential rings of conductive micro fibers that discharge voltages to ground.

## LonTalk® Communications Interface

The LonTalk communications interface allows the unit to communicate as a Tracer™ LCI-V device or directly with generic LonTalk Network Building Automation System Controls.

## Oversized Motors

Factory or field installed oversized motors are available for high static applications.

## Reference or Comparative Enthalpy

Measures and communicates humidity while maximizing comfort control.

## ReliaTel Options Module (RTOM)

The RTOM monitors the supply fan proving, clogged filter, supply air temperature, exhaust fan setpoint, dehumidification setpoint, supply air tempering, Froststat™ and smoke detector.

**Note:** The RTOM is standard on high efficiency units.

## Tool-less Hail Guards

Tool-less, hail protection quality coil guards (pictured right) shall be either factory or field-installed for condenser coil protection. This option protects the condenser coil from vandalism and/or hail damage.



## American Standard Communication Interface (TCI)

Available factory or field installed. This module when applied with the ReliaTel™ easily interfaces with American Standard's Integrated Comfort™ System.

## Field Installed Options<sup>1</sup>

### CO<sub>2</sub> Sensor - Demand Control Ventilation (DCV)

Demand-controlled ventilation (DCV) is a control strategy that responds to the actual demand (need) for ventilation by regulating the rate at which the HVAC system brings outdoor air into the building. A CO<sub>2</sub> sensor measures the concentration (parts per million, ppm) of CO<sub>2</sub> (Carbon Dioxide) in the air. As the CO<sub>2</sub> concentration changes, the outside air damper modulates to meet the current ventilation needs of the zone. The CO<sub>2</sub> sensor kit is available as a field installed accessory. Two field installed kits are offered; CO<sub>2</sub> sensor and wiring or CO<sub>2</sub> sensor only. The CO<sub>2</sub> sensor only kit should be ordered with factory installed CO<sub>2</sub> sensor wiring. Factory installed CO<sub>2</sub> sensor wiring saves set-up time and ensures proper unit connections for the CO<sub>2</sub> sensor.

### Dampers

0–25 percent manual or 0–50 percent motorized outside air dampers are available.

### Digital Display Zone Sensor

The Digital LCD (Liquid Crystal Display) zone sensor has the look and functionality of standard zone sensors.

<sup>1</sup> Refer to "Model Number Description," p. 24 for option availability.

# Voyager 2 Packaged Systems Features and Benefits

---

## Economizer - Standard, Horizontal

Economizers are equipped with either dry bulb or reference or comparative enthalpy sensing. These economizers provide free cooling as the outdoor temperature and/or humidity decreases. Correctly installed, they offer a valuable energy savings.

## Economizer - Low Leak, Downflow and Horizontal

This accessory meets low leak requirements for ASHRAE 90.1, IECC, and CA Title 24 standards (3 cfm/ft<sup>2</sup>@1" wg exterior air, 4 cfm/ft<sup>2</sup>@1" wg return air). This option allows 100% outdoor air supply from 0-100% modulating dampers and is standard with barometric relief. It can be paired with powered exhaust for additional building pressure relief.

## Humidity Sensor/Humidistat

Used in conjunction with our Dehumidification (Hot Gas Reheat) units to provide outstanding humidity control and comfort. Humidity sensors can be wall or duct mounted and set for levels between 40% and 60%.

## LP Conversion Kit

Provided for field conversion of gas/electric units from natural gas to propane.

## Outside Air Measuring/Monitoring Control (Traq Dampers)

Quantity of fresh air entering the unit will be measured and monitored via American Standard UC400 controller and series of pressure sensing rings mounted at the outside air intake.

## Powered Exhaust

This option is available on downflow units and provides exhaust of the return air, when using a downflow economizer, to maintain proper building pressurization. Great for relieving most building overpressurization problems.

## Remote Potentiometer

When properly installed in the economizer control circuitry, this accessory provides a remote variable resistance to enable the operator to adjust the minimum damper position.

## Roof Curbs

Available for downflow units. Only two roof curbs for the entire Voyager line simplifies curb selection.

## Static Drive Accessories

Available on many models, this high and low static drive accessories extend the capability of the standard motor. Avoid expensive motors and operating costs by installing this optimized sheave accessory.

## Ventilation Override Accessory

With the Ventilation Override Accessory installed, the unit can be set to transition to up to 3 different pre-programmed sequences for Smoke Purge, Pressurization and Exhaust. The transition occurs when a binary input on the RTOM is closed (shorted). This would typically be a hard wired relay output from a smoke detector or fire control panel. The ventilation override kit is available as a field installed accessory.

## Wireless Zone Sensor

LCD display that provides heat, cool, auto, or off. Includes two temperature setpoints and a lockable setting with °F or °C indicators.



# Voyager 2 Packaged Systems Features and Benefits

## Zone Sensors/Thermostats

Available in programmable, automatic and manual styles.

**Note:** Zone sensors required for units configured for Single Zone VAV indoor fan system control to enable Single Zone VAV functionality.

## Other Benefits

### Cabinet Integrity

For added water integrity, Voyager has a raised 1-1/8-inch lip around the supply and return of the downflow units to prevent water from blowing into the ductwork.

### Easy to Install, Service and Maintain

Because today's owners are very cost-conscious when it comes to service and maintenance, Voyager was designed with direct input from service contractors. This valuable information helped to design a product that would get the serviceman off the job quicker and save the owner money. Voyager does this by offering outstanding standard features enhanced by a variety of factory and field installed options, multiple control options, rigorously tested proven designs and superior product and technical support.

### Outstanding Airflow Distribution

Airflow is outstanding. The Voyager can replace an older machine with old ductwork and, in many cases, improve the comfort through better air distribution.

### ReliaTel™ Controls Benefits

ReliaTel controls provide unit control for heating, cooling and ventilating by utilizing input from sensors that measure outdoor and indoor temperature.

Quality and Reliability are enhanced through ReliaTel control and logic:

- Prevents the unit from short cycling, considerably improving compressor life.
- Ensures the compressor will run for a specific amount of time which allows oil to return for better lubrication, enhancing the reliability of the compressor.

Voyager with ReliaTel reduces the number of components required to operate the unit, thereby reducing possibilities for component failure.

### ReliaTel Makes Installing and Servicing Easy

ReliaTel eliminates the need for field installed anti-shortcycle timer and time delay relays.

ReliaTel controls provide these functions as an integral part of the unit. The contractor no longer has to purchase these controls as options and pay to install them. The wiring of the low voltage connections to the unit and the zone sensors is as easy as 1-1, 2-2, and 3-3. This simplified system makes wiring easier for the installer.

### ReliaTel Makes Testing Easy

ReliaTel requires no special tools to run Voyager unit through its paces. Simply place a jumper between Test 1 and Test 2 terminals on the Low Voltage Terminal Board and the unit will walk through its operational steps automatically.

The unit automatically returns control to the zone sensor after stepping through the test mode a single time, even if the jumper is left on the unit.

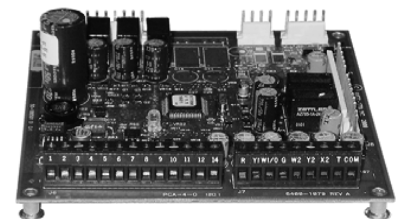

# Voyager 2 Packaged Systems Features and Benefits

---

As long as the unit has power and the “system on” LED is lit, ReliaTel is operational. The light indicates that the controls are functioning properly.

ReliaTel features expanded diagnostic capabilities when utilized with AmericanStandard Integrated Comfort™ Systems.

Some zone sensor options have central control panel lights which indicate the mode the unit is in and possible diagnostic information (dirty filters for example).

## **Other ReliaTel Benefits**

The ReliaTel built-in anti-shortcycle timer, time delay relay and minimum “on” time control functions are factory tested to assure proper operation. ReliaTel softens electrical “spikes” by staging on fans, compressors and heaters. Intelligent Fallback is a benefit to the building occupant. If a component goes astray, the unit will continue to operate at predetermined temperature setpoint.

Intelligent Anticipation is a standard ReliaTel feature. It functions continuously as ReliaTel and zone sensor(s) work together in harmony to provide much tighter comfort control than conventional electro-mechanical thermostats.

The same ReliaTel Board fits all Packaged Gas/Electric, Cooling, and Heat Pump models. This provides standardization of parts for contractors. Less money is tied up in inventory with ReliaTel.

## **Rigorous Testing**

All of Voyager’s designs were rigorously rain tested at the factory to ensure water integrity. Voyager units incorporate either a one piece top or the AmericanStandard-Tite-Top (T3). Each part of the top (either two or three pieces) overlaps in such a way that water cannot leak into the unit. These overlapped edges are gasketed and sealed to ensure superior water integrity.

Actual shipping tests were performed to determine packaging requirements. Units were test shipped around the country to determine the best packaging. Factory shake and drop tests were used as part of the package design process to help assure that the unit arrives at the job site in top condition.

Rigging tests include lifting a unit into the air and letting it drop one foot, assuring that the lifting lugs and rails hold up under stress. For the microchannel coils, the supplier will perform the leak check at 450 psig. The completely assembled refrigerant system is leak tested at a minimum of 225 psig with a refrigerant and nitrogen mixture.

All parts are inspected at the point of final assembly. Sub-standard parts are identified and rejected immediately. Every unit receives a 100% unit run test before leaving the production line to make sure it lives up to rigorous AmericanStandard requirements.

## **Unmatched Support**

American Standard Sales Representatives are a Support Group that can assist you with:

- Product
- Application
- Service
- Training
- Special Applications
- Specifications
- Computer Programs and much more

# Voyager 2 Packaged Systems Features and Benefits

## VariTrac® – Changeover-Bypass System

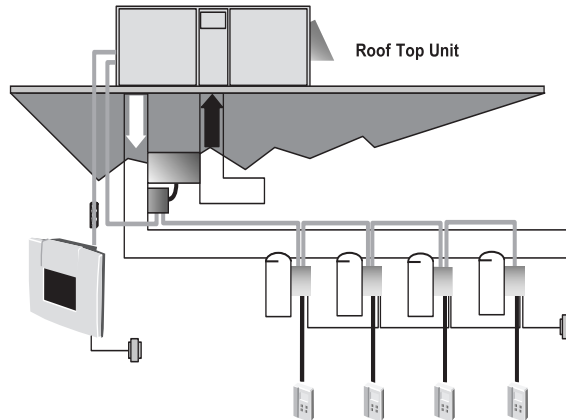

A changeover-bypass system consists of a packaged rooftop unit that serves several individually controlled zones. Each zone is equipped with a damper that varies the quantity of air delivered to maintain the desired temperature in that zone. However, unlike a conventional multiple-zone VAV system, the fan inside the rooftop unit operates at a constant speed. Any unneeded air is diverted to the return air stream through a bypass damper.

The term “changeover” refers to how this system handles the cooling and heating requirements of the building. The central rooftop unit can provide either cooled or heated air, and it makes this decision by periodically “polling” the zones.

ONLINE ONLY

# Voyager 2 Packaged Gas / Electric Application Considerations

---

Application of this product should be within the cataloged airflow and cooling considerations.

## Air-Fi® Wireless

Please refer to Air-Fi® Network Design Installation, Operation, and Maintenance manual BAS-SVX55\*-EN for additional details on applications with factory installed wireless.

## Barometric Relief

This product line offers a barometric relief damper for use in conjunction with economizer option. This accessory consists of gravity dampers which open with increased pressure. As the building air pressure increases, the pressure in the unit return air section also increases, opening the dampers and relieving the conditioned space.

**Note:** *The effectiveness of barometric relief damper during economizing operation is limited, depending on the pressure drop of the return-air path. For some applications, powered exhaust may be better suited for preventing over-pressurization when economizing.*

## Clearance Requirements

The recommended clearances identified with unit dimensions should be maintained to ensure adequate serviceability, maximum capacity and peak operating efficiency. Actual clearances which appear inadequate should be reviewed with local American Standard sales personnel.

## Complete Coat™ Microchannel Condenser Coil

The cathodic epoxy type electrodisposition coating is formulated for high edge build to a number of different types of heat exchangers. The coating is selected to provide excellent resistance and durability to corrosive effects of alkalis, acids, alcohols, petroleum, seawater, salt air, and corrosive environments. This coating shall be available on microchannel condenser coils.

## Condensate Trap

The evaporator is a draw-through configuration. A trap must be field provided prior to start-up on the cooling cycle.

## Dual Compressors — 3 Stages of Cooling (12½ to 20 Tons)

Using the ReliaTel™ microprocessor controls, the Voyager™ high efficiency line can provide three stages of cooling, allowing for a more efficient and comfortable cooling operation.

**Important:** *All high efficiency products will have intertwined evaporator coils as standard. No face split coils are allowed with 3 or 4 stages of cooling.*

**Note:** *Standard efficiency models do not have 3 stages of cooling operation.*

## 4 Stages of Cooling (25 Tons)

25 tons high efficiency units have 4 stages of cooling with a single compressor and tandem set (similar to variable speed).

## Heating Operation

The heat exchanger is manufactured with aluminized steel. To prevent condensation within the heat exchanger, do not exceed 50 percent outside air or a minimum mixed air temperature of 40°F.

## Optional Stainless Steel Heat Exchanger

The optional stainless steel heat exchanger is manufactured with 439 stainless steel. To prevent corrosion and prolong heat exchanger reliability, the minimum mixed air temperature allowed across the heat exchanger is 20°F. The stainless steel heat exchanger option is an excellent option that compliments the dehumidification package and is used in conjunction with the modulating heat option. Whenever high outside air or outside applications exist, these options should be utilized.

# Voyager 2 Packaged Gas / Electric Application Considerations

---

## Low Ambient Cooling

The Voyager line features, with ReliaTel™ microprocessor controls, low ambient cooling down to 0°F. A frostat needs to be included in the selection when Low Ambient Cooling is required. Contact your local American Standard Representative for more assistance with low ambient cooling applications.

## Unit Pitch

These units have sloped condensate drain pans. Units must be installed level. Any unit slope must be toward access side of the unit.

## Low Airflow

Unit applications designed for airflow below 320 cfm/ton are available on cooling only units and gas heat units equipped with modulating gas heat. Units must be high efficiency units with dehumidification (hot gas reheat) or TXV with Frostat and Crankcase heaters. Electric heat is restricted below 320 cfm/ton. Standard efficiency units are restricted below 250 cfm/ton. Multi-speed or single zone VAV applications are capable of running below 320 cfm/ton during low speed airflow operation, but "full" airflow must be set to 320 cfm/ton or higher.

## VariTrac®

VariTrac is for Voyager units with constant-speed indoor fan control. It is not recommended for use with Multiple-Speed Indoor Fan Control, Single-Zone VAV Control, or Multiple-Zone VAV Control.

# Voyager 2 Packaged Gas / Electric Selection Procedure

## Cooling Capacity

**Note:** Cooling Capacity Procedure is the same for cooling (T\*) and gas/electric (Y\*).

### Step 1.

Calculate the building's total and sensible cooling loads at design conditions. Use the following calculation methods or any other standard accepted method. Factors used in unit selection:

Total Cooling Load: 180 MBh  
 Sensible Cooling Load: 126 MBh  
 Airflow: 6000 cfm  
 Electrical Characteristics: 460/60/3  
 Summer Design Conditions: Entering Evaporator Coil: 80 DB, 67 WB Outdoor Ambient: 95 DB  
 External Static Pressure: 0.39 in. wg  
 Rooftop—downflow configuration  
 Accessories

- Roof curb
- Economizer
- Electric Heat

### Step 2.

As a starting point, a rough determination must be made of the size of the unit. The final selection will be made after examining the performance at the given conditions. Divide the total cooling load by nominal Btu/h per ton (12 MBh per ton); then round up to the nearest unit size.

$$180 \text{ MBh} / 12 \text{ MBh} = 15.0 \text{ tons}$$

### Step 3.

Table 16, p. 39 shows that a TSD180F4 has a **gross** cooling capacity of 186.1 MBh and 139.1 MBh sensible capacity at 6000 cfm and 95 DB outdoor ambient with 80 DB, 67 WB air entering the evaporator.

### To Find Capacity at Intermediate Conditions Not in the Table.

When the design conditions are between two numbers that are in the capacity table, interpolation is required to approximate the capacity.

**Note:** Extrapolation outside of the table conditions is not recommended.

### Step 4.

In order to select the correct unit which meets the building's requirements, the fan motor heat must be deducted from the gross cooling capacity. The amount of heat that the fan motor generates is dependent on the effort by the motor—cfm and static pressure. To determine the total unit static pressure you add the external static pressure to the additional static related by the added features:

External Static Duct System	0.39 wg
Standard Filter 2 in. from Table 85, p. 115	0.06 wg
Economizer from Table 85, p. 115 (100% Return Air)	0.04 wg
Electric Heater Size 36 kW from Table 85, p. 115	0.07 wg
(Reference "Heating Capacity," p. 23 for determination of heater size.) No additional static add for gas/heat exchanger.	
<b>Total Static Pressure</b>	<b>0.56 wg</b>

**Note:** The Evaporator Fan Performance Table 45, p. 78 has already accounted for the pressure drop for standard filters and wet coils (see note below Table 45). Therefore, the actual total static pressure is 0.56 - 0.06 (from Table 85, p. 115 = 0.50 wg).

# Voyager 2 Packaged Gas / Electric Selection Procedure

With 6000 cfm and 0.50 wg.

Table 45, p. 78 shows 1.95 bhp for this unit. Note below the table gives a formula to calculate Fan Motor Heat,

$3.15 \times \text{bhp} = \text{MBh}$ .

$3.15 \times 1.95 = 6.14 \text{ MBh}$ .

Now subtract the fan motor heat from the gross cooling capacity of the unit:

**Net Total Cooling Capacity** =  $186.1 \text{ MBh} - 6.14 = 179.96 \text{ MBh}$ .

**Net Sensible Cooling Capacity** =  $139.1 \text{ MBh} - 6.14 = 132.96 \text{ MBh}$ .

## Step 5.

If the performance will not meet the required load of the building—total or sensible cooling load, try a selection at the next higher size unit.

## Heating Capacity

**Note:** Heating capacity procedures DIFFER for cooling ( $T^*$ ) and gas/electric ( $Y^*$ ) units.

### Step 1.

Calculate the building heating load.

### Step 2.

Size the system heating capacity to match the calculated building heating load. The following are building heating requirements:

$T^*$  cooling units:

460 volt/3 phase Power Supply

Total heating load of 115.0 MBh

6000 cfm

The electric heat accessory capacities are listed in Table 87, p. 117. From the table, a 36 kW heater will deliver 122.94 MBh at 480 volts. In order to determine capacity at 460 volts, the heater voltage correction factor from Table 88, p. 118 must be used. Therefore,  $122.94 \text{ MBh} \times .94$  (voltage correction factor) = 115.6 MBh.

$Y^*$  gas/electric: Fuel natural gas total heating load of 195 MBh. Table 86, p. 117 shows 250 MBh and 350 MBh input models. The output capacities of these furnaces are 203 MBh and 284 MBh respectively. The low heat model with 203 MBh output best matches the building requirements.

## Air Delivery Selection

**Note:** Air Delivery procedures is the same for cooling ( $T^*$ ) and gas/electric ( $Y^*$ ) units.

External static pressure drop through the air distribution system has been calculated to be 0.50 inches of water. From Table 85, p. 115 static pressure drop through the economizer is 0.04 and the 36 kW heater is 0.07 inches of water ( $0.39 + 0.04 + 0.07$ ). Enter Table 45, p. 78 for a TSD180F4 at 6000 cfm and 0.50 static pressure. The standard motor at 533 rpm will give the desired airflow at a rated bhp of 1.92.

# Voyager 2 Packaged Gas / Electric Model Number Description

## Digit 1 — Unit Type

- T = Packaged Cooling, Electric Heat
- Y = Packaged Cooling, Gas Heat

## Digit 2 — Efficiency

- S = Standard Efficiency
- H = High Efficiency

## Digit 3 — Airflow Configuration

- D = Downflow
- H = Horizontal

## Digit 4, 5, 6 — Nominal Gross Cooling Capacity (MBh)

- 150 = 12½ Tons
- 180 = 15 Tons
- 210 = 17½ Tons, 60Hz DOE 2018
- 240 = 20 Tons
- 300 = 25 Tons, 60Hz DOE 2018

## Digit 7 — Major Design Sequence

- G = ASHRAE 90.1-2013 (Fan/Compressor Staging)<sup>13</sup> or Microchannel Type Evaporator and Condenser Coils

## Digit 8 — Voltage Selection

- 3 = 208-230/60/3
- 4 = 460/60/3
- W = 575/60/3
- K = 380/60/3

## Digit 9 — Unit Controls

- R = Reliatel

## Digit 10 — Heating Capacity

**Note:** (Applicable to Digit 1 T models only)

- 0 = No Heat
- G = 18 kW Electric Heat
- K = 27 kW Electric Heat
- N = 36 kW Electric Heat
- P = 54 kW Electric Heat
- R = 72 kW Electric Heat

**Note:** (Applicable to Digit 1 Y models only)

- H = Gas Heat - High
- L = Gas Heat - Low
- V = Gas Heat - SS Ht Ex - Modulating
- X = Gas Heat - SS Ht Ex - Low
- Z = Gas Heat - SS Ht Ex - High

## Digit 11 — Minor Design Sequence

## Digit 12, 13 — Service Sequence

- 00 = None
- 01 = 18mm Microchannel Condenser Coil

**Note:** '01' only available on select models.

## Digit 14 — Fresh Air Selection

- 0 = No Fresh Air
- D = Econ Dry Bulb w/ Barometric Relief<sup>1</sup>

- F = Econ Reference Enthaply w/ Barometric Relief<sup>1</sup>
- H = Econ Comparative Enthaply w/ Barometric Relief<sup>1</sup>
- K = Low Leak Econ w/ Barometric Relief<sup>1</sup>
- M = Low Leak Econ Reference Enthaply w/ Barometric Relief<sup>1</sup>
- P = Low Leak Econ Comparative Enthaply w/ Barometric Relief<sup>1</sup>

## Digit 15 — Supply Fan/Drive Type/Motor

- 0 = Standard Motor
- 1 = Oversized Motor<sup>6</sup>
- 3 = High Efficiency Motor<sup>6</sup>
- 6 = Single Zone Variable Air Volume Standard Motor
- 7 = Multi-Speed Standard Motor
- 8 = Single Zone Variable Air Volume Oversized Motor
- 9 = Multi-Speed Oversized Motor
- A = Single Zone Variable Air Volume Standard Motor w/ Shaft Grounding Ring
- B = Multi-Speed Standard Motor w/ Shaft Grounding Ring
- C = Single Zone Variable Air Volume Oversized Motor w/ Shaft Grounding Ring
- D = Multi-Speed Oversized Motor w/ Shaft Grounding Ring
- E = VAV Supply Air Temperature Control - Standard Motor
- F = VAV Supply Air Temperature Control - Oversized Motor
- G = VAV Supply Air Temperature Control - Standard Motor w/ Shaft Grounding Ring
- H = VAV Supply Air Temperature Control - Oversized Motor w/ Shaft Grounding Ring

## Digit 16 — Hinged Service Access / Filters

- 0 = Standard Panels/Standard Filters<sup>22</sup>
- A = Hinged Access/Standard Filters<sup>22</sup>
- B = Standard Panels/MERV 8 Filters<sup>6</sup>
- C = Hinged Access/MERV 8 Filters<sup>6</sup>
- D = Standard Panels/MERV 13 Filters<sup>6</sup>
- E = Hinged Access/MERV 13 Filters<sup>6</sup>

## Digit 17 — Condenser Coil Protection

- 0 = Standard Coil
- 1 = Standard Coil With Hail Guard
- 4 = CompleteCoat™ Condenser Coil
- 5 = CompleteCoat™ Condenser Coil with Hail Guard

## Digit 18 — Through The Base Provisions

**Note:** Applicable to Digit 1, T or Y models.

- 0 = No Through The Base Provisions
- A = Through The Base Electric<sup>12</sup>

**Note:** Applicable to Digit 1, Y models only.

- B = Through The Base Gas
- C = Through The Base Electric/Gas<sup>12</sup>
- D = Through The Base Access

## Digit 19 — Disconnect Switch/Circuit Breaker<sup>11</sup>

- 0 = No Disconnect/circuit break
- 1 = Unit Mounted Non-Fused Disconnect Switch
- 2 = Unit Mounted Circuit Breaker

## Digit 20 — Convenience Outlet Option

- 0 = Without Convenience Outlet
- A = Unpowered Convenience Outlet<sup>5</sup>
- B = Powered Convenience Outlet<sup>5</sup>

## Digit 21 — Communications Options

- 0 = Without Communications Options
- 1 = American Standard Communications Interface<sup>6, 15</sup>
- 2 = Lontalk Communications Interface<sup>6</sup>
- 6 = Building Automation Control Network Communications Interface
- 7 = Air-Fi® Wireless Communications<sup>24</sup>

## Digit 22 — Refrigeration System Option

- 0 = Standard refrigeration system
- B = Dehumidification (Hot Gas Reheat)<sup>4,13</sup>

## Digit 23 — Refrigeration Controls

- 0 = Without Refrigeration Controls
- 1 = Frostat<sup>9, 18</sup>

## Digit 24 — Smoke Detector<sup>2,10</sup>

- 0 = Without Smoke Detector
- A = Return Air Smoke Detector
- B = Supply Air Smoke Detector
- C = Return/Supply Air Smoke Detector
- D = Plenum Smoke Detector<sup>19</sup>

## Digit 25 — System Monitoring Controls

- 0 = No Monitoring Controls
- 1 = Clogged Filter Switch<sup>9</sup>
- 2 = Fan Failure Switch<sup>9</sup>
- 3 = Discharge Air Sensing<sup>9</sup>
- 4 = Clogged Filter Switch and Fan Failure switch<sup>9</sup>



# Voyager 2 Packaged Gas / Electric Model Number Description

- 5 = Clogged Filter Switch and Discharge Air Sensing<sup>9</sup>
- 6 = Fan Failure Switch and Discharge Air Sensing<sup>9</sup>
- 7 = Clogged Filter Switch, Fan Failure Switch and Discharge Air Sensing<sup>9</sup>
- A = Condensate Drain Pan Overflow Switch
- B = Clogged Filter Switch and Condensate Drain Pan Overflow Switch<sup>9</sup>
- C = Fan Failure Switch and Condensate Drain Pan Overflow Switch<sup>9</sup>
- D = Discharge Air Sensing and Condensate Drain Pan Overflow Switch<sup>9</sup>
- E = Clogged Filter Switch, Fan Failure Switch and Condensate Drain Pan Overflow Switch<sup>9</sup>
- F = Clogged Filter Switch, Discharge Air Sensing Tube and Condensate Drain Pan Overflow Switch<sup>9</sup>
- G = Fan Failure Switch, Discharge Air Sensing Tube and Condensate Drain Pan Overflow Switch<sup>9</sup>
- H = Clogged Filter Switch, Fan Failure Switch, Discharge Air Sensing and Condensate Drain Pan Overflow Switch<sup>9</sup>

## Digit 26 - System Monitoring Controls

- 0 = No Monitoring Controls
- A = Demand Control Ventilation (CO<sub>2</sub>)<sup>17</sup>
- B = FDD (Fault Detection and Diagnostics)
- C = FDD (Fault Detection Diagnostics) and Demand Control Ventilation (CO<sub>2</sub>)<sup>17</sup>

## Digit 27 - Unit Hardware Enhancements

- 0 = No Enhancements
- 1 = Stainless Steel Drain Pan

## Digit 28 - Short Circuit Current Rating

- 0 = Standard SCCR
- A = 65kA SCCR Option<sup>20, 21</sup>

## Digit 31 - Advanced Unit Controls

- 0 = Standard Unit Controls
- 1 = Human Interface<sup>23</sup>

**Note:** *Most Factory Installed Options available for Downflow Air Discharge units only. Please verify with ordering system for availability.*

## Model Number Notes

1. Some field set up required.
2. Requires ReliaTel Options Module.
3. Requires Economizer.
4. All 22<sup>nd</sup> digit model numbers for reheat coil (B) require additional factory installed options: Froststat, and 2-inch pleated filters.
5. Must be ordered with Through-the-Base Electrical option or Horizontal-Side Access and either Unit Mounted Disconnect or Circuit Breaker.
6. Available factory installed on downflow AND horizontal units. Verify with ordering system.
7. Cannot be fused.
8. Must be factory installed when using Through-the-Base Options.
9. ReliaTel Options Module is required when ordering the following accessories: 4 Stage Cooling, Clogged Filter Switch, Fan Fail Switch, Condensate Overflow Switch, Discharge Air Sensing Kit, Froststat, Ventilation Override, Smoke Detector, Dehumidification and Modulating Gas Heat Furnace.
10. Option cannot be ordered in conjunction with field installed economizer on downflow units. Must be factory installed. The return air smoke detector may not fit up or work properly on the Voyager units when used in conjunction with 3<sup>rd</sup> party accessories (such as bolt on heat wheels, economizers, and power exhaust). Do not order the return air smoke detectors when using this type of accessory.
11. Unit mounted disconnect and circuit breakers are mutually exclusive of each other.
12. Through-the-base electrical option or Horizontal-Side Access must be ordered with either unit mounted disconnect or circuit breaker. When adding heat, you must order American Standard Electric Heat.
13. Available on high efficiency units only.
14. All Factory Installed Options are Built-to-Order. Check order services for estimated production cycle.
15. TCI is for use with non-VariTrac systems and VariTrac systems.
16. For use with multi-speed and SZVAV units only.
17. Demand Control Ventilation Option includes wiring only. The CO<sub>2</sub> sensor is a field-installed only option.
18. Froststat is standard on VAV and high efficiency units.
19. Supply and/or return smoke detector may not be used with the plenum smoke detector.
20. Only available where MOP is above 60A.
21. 575 Vac option is 25kA.
22. Standard filters are not available with Low Leak Economizers.
23. Human Interface is standard with FDD (Fault Detection Diagnostics).
24. Must be used with BACnet® open protocol.

# Voyager 2 Packaged Gas / Electric General Data

**Table 3. General data—cooling 12½–15 tons standard efficiency**

	12½ Tons Downflow and Horizontal Units		15 Tons Downflow and Horizontal Units	
	TS*150G3,4,W,K	YS*150G3,4,W,K	TS*180G3,4,W,K	YS*180G3,4,W,K
<b>Cooling Performance<sup>(a)</sup></b>				
Gross Cooling Capacity	150,000	150,000	186,000	186,000
EER (Downflow/Horizontal) <sup>(b)</sup>	11	11	11	11
Nominal Airflow CFM / AHRI Rated CFM	5,000 / 4,000	5,000 / 4,000	6,000 / 5,400	6,000 / 5,400
AHRI Net Cooling Capacity	140,000	140,000	176,000	176,000
Integrated Energy Efficiency Ratio (IEER) (One Speed Fan / Multi or Variable Speed Fan) <sup>(c)</sup>	12.4/13.5	12.2/13.5	12.4/13.2	12.2/13.2
Percent Capacity @ part load (Stage 1/Stage 2)	66/100	66/100	67/100	67/100
System Power (kW)	12.73	12.73	16.00	16.00
<b>Compressor</b>				
Number/Type	2 / Scrolls	2 / Scrolls	2 / Scrolls	2 / Scrolls
<b>Sound</b>				
Outdoor Sound Rating (BELS) <sup>(d)</sup>	9.2	9.2	9.2	9.2
<b>Outdoor Coil</b>				
Type	Microchannel	Microchannel	Microchannel	Microchannel
Coil Width (in.)	0.71	0.71	0.71	0.71
Face Area (sq. ft.)	25.9	25.9	35.2	35.2
Rows/FPI (DF/HZ)	1/23	1/23	1/23	1/23
<b>Indoor Coil</b>				
Type	Microchannel	Microchannel	Microchannel	Microchannel
Coil Width (in.)	1.00	1.00	0.81	0.81
Face Area (sq. ft.)	17.30	17.30	23.00	23.00
Rows/FPI	2/16	2/16	2/16	2/16
Refrigerant Control	TXV	TXV	TXV	TXV
Drain Connection Number/Size (in.)	1/1.00 NPT	1/1.00 NPT	1/1.00 NPT	1/1.00 NPT
<b>Outdoor Fan</b>				
Type	Propeller	Propeller	Propeller	Propeller
Number Used/Diameter (in.)	2 / 26	2 / 26	2 / 26	2 / 26
Drive Type/No. Speeds	Direct / 1	Direct / 1	Direct / 1	Direct / 1
cfm	11,000	11,000	11,000	11,000
Number Motors/hp	2 / 0.50	2 / 0.50	2 / 0.50	2 / 0.50
Motor rpm	1,100	1,100	1,100	1,100
<b>Indoor Fan</b>				
Type	FC Centrifugal	FC Centrifugal	FC Centrifugal	FC Centrifugal
Number Used/Diameter (in.)	1 / 15x15	1 / 15x15	1 / 18x18	1 / 18x18
Drive Type/No. Speeds	Belt / 1	Belt / 1	Belt / 1	Belt / 1
Number Motors	1	1	1	1
Motor hp (Standard/Oversized) <sup>(e)</sup>	3.0 / 5.0	3.0 / 5.0	3.0 / 5.0 or 7.5 <sup>(f)</sup>	3.0 / 5.0 or 7.5 <sup>(f)</sup>
Motor rpm (Standard/Oversized)	1,740 / 3,450	1,740 / 3,450	1,740 / 3,450	1,740 / 3,450
Motor Frame Size (Standard/Oversized)	56HZ / 56HZ	56HZ / 56HZ	184TZ / 56HZ/184TZ	56HZ / 56HZ/184TZ

Light Commercial  
Voyager Packaged Systems

# Voyager 2 Packaged Gas / Electric General Data

**Table 3. General data—cooling 12½–15 tons standard efficiency (continued)**

	12½ Tons Downflow and Horizontal Units		15 Tons Downflow and Horizontal Units	
	TS*150G3,4,W,K	YS*150G3,4,W,K	TS*180G3,4,W,K	YS*180G3,4,W,K
<b>Filters</b>				
Type Furnished <sup>(g)</sup>	Throwaway	Throwaway	Throwaway	Throwaway
Number Size Recommended				
Downflow	(2)20x20x2 (4)20x25x2	(2)20x20x2 (4)20x25x2	(4)20x20x2 (4)20x25x2	(4)20x20x2 (4)20x25x2
Horizontal	(2)20x20x2 (4)20x25x2	(2)20x20x2 (4)20x25x2	(8)20x25x2	(8)20x25x2
<b>Refrigerant Charge (Pounds of R-410A)<sup>(h)</sup></b>				
Cir#1 / Cir#2 (DF)	8.1/5.1	8.1/5.1	9.0/5.0	9.0/5.0
Cir#1 / Cir#2 (HZ)	8.1/5.2	8.1/5.2	9.2/5.1	9.2/5.1

- (a) Cooling Performance is rated at 95°F ambient, 80°F entering dry bulb, 67°F entering wet bulb. Gross capacity does not include the effect of fan motor heat. AHRI capacity is net and includes the effect of fan motor heat. Units are suitable for operation to ±20% of nominal cfm. Certified in accordance with the Unitary Large Equipment Certification Program, which is based on AHRI Standard 340/360.
- (b) EER is rated at AHRI conditions and in accordance with AHRI Standard 210/240 or 340/360.
- (c) Integrated Energy Efficiency Ratio (IEER) is rated in accordance with AHRI standard 210/240 or 340/360.
- (d) Outdoor Sound Rating shown is tested in accordance with AHRI Standard 270 or 370.
- (e) For 380V/60Hz units, the oversized motor (Indoor Fan) is used as the standard motor. Refer to oversized motor data.
- (f) Offered only as a field installed accessory.
- (g) An optional 2-inch pleated filter is also available.
- (h) Refrigerant charge is an approximate value. For a more precise value, see unit nameplate and service instructions.
- \* Indicates both downflow and horizontal units.

**Table 4. General data—heating—12½–15 tons standard efficiency**

	12½ Tons Downflow and Horizontal Units			15 Tons Downflow and Horizontal Units		
	Heating Performance <sup>(a)</sup> (Gas/Electric Only)					
Heating Models	Low	High	Modulating Turn Down = 2.5:1	Low	High	Modulating Turn Down = 2.5:1
<b>Heating Input (Btu/h)</b>	150,000	250,000	350,000	250,000	350,000	350,000
1st Stage (Btu)	100,000	175,000	140,000	175,000	250,000	140,000
<b>Heating Output (Btu/h)</b>	120,000	200,000	280,000	200,000	280,000	280,000
1st Stage (Btu)	80,000	140,000	112,000	140,000	200,000	112,000
<b>Steady State Efficiency%</b>	80	80	80	80	80	80
<b>No. Burners</b>	1	1	1	1	1	1
<b>No. Stages</b>	2	2	N/A	2	2	N/A
<b>Gas Supply Line Pressure (in. wc)</b>	2.5/14.0	2.5/14.0	2.5/14.0	2.5/14.0	2.5/14.0	2.5/14.0
Natural or LP (minimum/maximum)	Natural or LP	Natural or LP	Natural Only	Natural or LP	Natural or LP	Natural Only
<b>Gas Connection Pipe Size (in.)</b>	1/2	1/2	3/4	1/2	3/4	3/4

- (a) Heating Performance limit settings and rating data were established and approved under laboratory test conditions using American National Standards Institute standards. Ratings shown are for elevations up to 2000 feet. For elevations above 2000 feet, ratings should be reduced at the rate of 4% for each 1000 feet above sea level.

# Voyager 2 Packaged Gas / Electric General Data

**Table 5. General data—17½–20 tons standard efficiency**

	17½ Tons Downflow and Horizontal Units		20 Tons Downflow and Horizontal Units	
	TS*210G3,4,W,K	YS*210G3,4,W,K	TS*240G3,4,W,K	YS*240G3,4,W,K
<b>Cooling Performance<sup>(a)</sup></b>				
Gross Cooling Capacity	210,000	210,000	259,000	259,000
EER (Downflow/Horizontal) <sup>(b)</sup>	11	11	10	10
Nominal Airflow CFM / AHRI Rated CFM	7,000 / 6,125	7,000 / 6,125	8,000 / 6,400	8,000 / 6,400
AHRI Net Cooling Capacity	196,000	196,000	240,000	240,000
Integrated Energy Efficiency Ratio (IEER) (One Speed Fan / Multi or Variable Speed Fan) <sup>(c)</sup>	12.4/13.2	12.2/13.2	11.6/12.4	11.4/12.4
Percent Capacity @ part load (Stage 1/Stage 2)	67/100	67/100	67/100	67/100
System Power (kW)	17.82	17.82	24.00	24.00
<b>Compressor</b>				
Number/Type	2 / Scrolls	2 / Scrolls	2 / Scrolls	2 / Scrolls
<b>Sound</b>				
Outdoor Sound Rating (BELS) <sup>(d)</sup>	9.4	9.4	9.4	9.4
<b>Outdoor Coil</b>				
Type	Microchannel	Microchannel	Microchannel	Microchannel
Coil Width (in.)	1.00	1.00	1.0	1.0
Face Area (sq. ft.)	35.2	35.2	35.2	35.2
Rows/FPI (DF/HZ)	1/20	1/20	1/23 / 1/20	1/23 / 1/20
<b>Indoor Coil</b>				
Type	Microchannel	Microchannel	Microchannel	Microchannel
Tube Size (in.) ID	1.00	1.00	1.00	1.00
Face Area (sq. ft.)	23.00	23.00	23.00	23.00
Rows/FPI	2 / 16	2 / 16	2 / 16	2 / 16
Refrigerant Control	TXV	TXV	TXV	TXV
Drain Connection Number/Size (in.)	1/1.00 NPT	1/1.00 NPT	1/1.00 NPT	1/1.00 NPT
<b>Outdoor Fan</b>				
Type	Propeller	Propeller	Propeller	Propeller
Number Used/Diameter (in.)	2 / 26	2 / 26	2 / 26	2 / 26
Drive Type/No. Speeds	Direct / 1	Direct / 1	Direct / 1	Direct / 1
cfm	14,500	14,500	15,500	15,500
Number Motors/hp	2 / 1.0	2 / 1.0	2 / 1.0	2 / 1.0
Motor rpm	1125	1125	1125	1125
<b>Indoor Fan</b>				
Type	FC Centrifugal	FC Centrifugal	FC Centrifugal	FC Centrifugal
Number Used/Diameter (in.)	1 / 18x18	1 / 18x18	1 / 18x18	1 / 18x18
Drive Type/No. Speeds	Belt / 1	Belt / 1	Belt / 1	Belt / 1
Number Motors	1	1	1	1
Motor hp (Standard/Oversized) <sup>(e)</sup>	5.0 / 7.5	5.0 / 7.5	5.0 / 7.5	5.0 / 7.5
Motor rpm (Standard/Oversized)	3,450 / 3,470	3,450 / 3,470	3,450 / 3,470	3,450 / 3,470
Motor Frame Size (Standard/Oversized)	56HZ / 184T	56HZ / 184T	56HZ / 184T	56HZ / 184T

Light Commercial  
Voyager Packaged Systems

# Voyager 2 Packaged Gas / Electric General Data

**Table 5. General data – 17½–20 tons standard efficiency (continued)**

	17½ Tons Downflow and Horizontal Units		20 Tons Downflow and Horizontal Units	
	TS*210G3,4,W,K	YS*210G3,4,W,K	TS*240G3,4,W,K	YS*240G3,4,W,K
<b>Filters</b>				
Type Furnished <sup>(f)</sup>	Throwaway	Throwaway	Throwaway	Throwaway
Number Size Recommended				
Downflow	(4)20x20x2 (4)20x25x2	(4)20x20x2 (4)20x25x2	(4)20x20x2 (4)20x25x2	(4)20x20x2 (4)20x25x2
Horizontal	(8)20x25x2	(8)20x25x2	(8)20x25x2	(8)20x25x2
<b>Refrigerant Charge (Pounds of R-410A)</b>				
Cir#1/Cir#2 (DF)	12.6/6.8	12.6/6.8	12.4/7.2	12.4/7.2
Cir#1/Cir#2 (HZ)	12.0/6.8	12.0/6.8	11.7/6.8	11.7/6.8

- (a) Cooling Performance is rated at 95°F ambient, 80°F entering dry bulb, 67°F entering wet bulb. Gross capacity does not include the effect of fan motor heat. AHRI capacity is net and includes the effect of fan motor heat. Units are suitable for operation to ±20% of nominal cfm. Certified in accordance with the Unitary Large Equipment Certification Program, which is based on AHRI Standard 340/360.
  - (b) EER is rated at AHRI conditions and in accordance with AHRI Standard 210/240 or 340/360.
  - (c) Integrated Energy Efficiency Ratio (IEER) is rated in accordance with AHRI standard 210/240 or 340/360.
  - (d) Outdoor Sound Rating shown is tested in accordance with AHRI Standard 270 or 370.
  - (e) For 380V/60Hz units, the oversized motor (Indoor Fan) is used as the standard motor. Refer to oversized motor data.
  - (f) Refrigerant charge is an approximate value. For a more precise value, see unit nameplate and service instructions.
- \* Indicates both downflow and horizontal units.

**Table 6. General data—heating – 17½–20 tons standard efficiency**

	17½ Tons Downflow and Horizontal Units			20 Tons Downflow and Horizontal Units		
	Heating Performance <sup>(a)</sup> (Gas/Electric Only)					
Heating Models	Low	High	Modulating Turn Down = 2.5:1	Low	High	Modulating Turn Down = 2.5:1
<b>Heating Input (Btu/h)</b>						
1st Stage (Btu)	250,000	350,000	350,000	250,000	400,000	350,000
<b>Heating Output (Btu/h)</b>						
1st Stage (Btu)	175,000	250,000	140,000	175,000	300,000	140,000
<b>Steady State Efficiency%</b>	200,000	280,000	280,000	200,000	320,000	280,000
1st Stage (Btu)	140,000	200,000	112,000	140,000	240,000	112,000
<b>No. Burners</b>	80	80	80	80	80	80
<b>No. Stages</b>	1	1	1	1	1	1
<b>Gas Supply Line Pressure (in. wc)</b>	2	2	N/A	2	2	N/A
Natural or LP (minimum/maximum)	2.5/14.0	2.5/14.0	2.5/14.0	2.5/14.0	2.5/14.0	2.5/14.0
<b>Gas Connection Pipe Size (in.)</b>	Natural or LP	Natural or LP	Natural Only	Natural or LP	Natural or LP	Natural Only
	1/2	3/4	3/4	1/2	3/4	3/4

- (a) Heating Performance limit settings and rating data were established and approved under laboratory test conditions using American National Standards Institute standards. Ratings shown are for elevations up to 2000 feet. For elevations above 2000 feet, ratings should be reduced at the rate of 4% for each 1000 feet above sea level.

# Voyager 2 Packaged Gas / Electric General Data

**Table 7. General data—25 tons standard efficiency**

	25 Tons Downflow and Horizontal Units	
	TS*300G3,4,W,K	YS*300G3,4,W,K
<b>Cooling Performance<sup>(a)</sup></b>		
Gross Cooling Capacity	285,300	285,300
EER (Downflow/Horizontal) <sup>(b)</sup>	10	10
Nominal Airflow CFM / AHRI Rated CFM	10,000 / 8,000	10,000 / 8,000
AHRI Net Cooling Capacity	266,000	266,000
Integrated Energy Efficiency Ratio (IEER) (One Speed Fan / Multi or Variable Speed Fan) <sup>(c)</sup>	11.6/12.4	11.4/12.4
Percent Capacity @ part load (Stage 1/Stage 2)	66/100	66/100
System Power (kW)	27	27
<b>Compressor</b>		
Number/Type	2 / Scrolls	2 / Scrolls
<b>Sound</b>		
Outdoor Sound Rating (BELS) <sup>(d)</sup>	9.4	9.4
<b>Outdoor Coil</b>		
Type	Microchannel	Microchannel
Coil Width (in.)	1.0	1.0
Face Area (sq. ft.)	35.2	35.2
Rows/FPI (DF/HZ)	1/23 / 1/20	1/23 / 1/20
<b>Indoor Coil</b>		
Type	Microchannel	Microchannel
Tube Size (in.) ID	1.00	1.00
Face Area (sq. ft.)	23.00	23.00
Rows/FPI	2 / 16	2 / 16
Refrigerant Control	TXV	TXV
Drain Connection Number/Size (in.)	1/1.00 NPT	1/1.00 NPT
<b>Outdoor Fan</b>		
Type	Propeller	Propeller
Number Used/Diameter (in.)	2 / 28	2 / 28
Drive Type/No. Speeds	Direct / 1	Direct / 1
cfm	16,100	16,100
Number Motors/hp	2 / 1.0	2 / 1.0
Motor rpm	1125	1125
<b>Indoor Fan</b>		
Type	FC Centrifugal	FC Centrifugal
Number Used/Diameter (in.)	1 / 18x18	1 / 18x18
Drive Type/No. Speeds	Belt / 1	Belt / 1
Number Motors	1	1
Motor hp (Standard/Oversized)	7.5 / N/A	7.5 / N/A
Motor rpm (Standard/Oversized)	3,470 / N/A	3,470 / N/A
Motor Frame Size (Standard/Oversized)	184T / N/A	184T / N/A

Light Commercial  
Voyager Packaged Systems

# Voyager 2 Packaged Gas / Electric General Data

**Table 7. General data—25 tons standard efficiency (continued)**

	25 Tons Downflow and Horizontal Units	
	TS*300G3,4,W,K	YS*300G3,4,W,K
<b>Filters</b>		
Type Furnished <sup>(e)</sup>	Throwaway	Throwaway
Number Size Recommended		
Downflow	(4)20x20x2 (4)20x25x2	(4)20x20x2 (4)20x25x2
Horizontal	(8)20x25x2	(8)20x25x2
<b>Refrigerant Charge (Pounds of R-410A)<sup>(f)</sup></b>		
Cir#1/Cir#2 (DF)	12.5/6.7	12.5/6.7
Cir#1/Cir#2 (HZ)	11.7/6.7	11.7/6.7

(a) Cooling Performance is rated at 95°F ambient, 80°F entering dry bulb, 67°F entering wet bulb. Gross capacity does not include the effect of fan motor heat. AHRI capacity is net and includes the effect of fan motor heat. Units are suitable for operation to ±20% of nominal cfm. Certified in accordance with the Unitary Large Equipment Certification Program, which is based on AHRI Standard 340/360.

(b) EER is rated at AHRI conditions and in accordance with AHRI Standard 210/240 or 340/360.

(c) Integrated Energy Efficiency Ratio (IEER) is rated in accordance with AHRI standard 210/240 or 340/360.

(d) Outdoor Sound Rating shown is tested in accordance with AHRI Standard 270 or 370.

(e) An optional 2-inch pleated filter is also available.

(f) Refrigerant charge is an approximate value. For a more precise value, see unit nameplate and service instructions.

\* Indicates both downflow and horizontal units.

**Table 8. General data—heating—25 tons**

	25 Tons Downflow and Horizontal Units		
	Heating Performance <sup>(a)</sup> (Gas/Electric Only)		
Heating Models	Low	High	Modulating Turn Down = 2.5:1
<b>Heating Input (Btu/h)</b>	250,000	400,000	350,000
1st Stage (Btu)	175,000	300,000	140,000
<b>Heating Output (Btu/h)</b>	200,000	320,000	280,000
1st Stage (Btu)	140,000	240,000	112,000
<b>Steady State Efficiency%</b>	80	80	80
<b>No. Burners</b>	1	1	1
<b>No. Stages</b>	2	2	N/A
<b>Gas Supply Line Pressure (in. wc)</b>	2.5 / 14.0	2.5 / 14.0	2.5 / 14.0
Natural or LP (minimum/maximum)	Natural or LP	Natural or LP	Natural Only
<b>Gas Connection Pipe Size (in.)</b>	½	¾	¾

(a) Heating Performance limit settings and rating data were established and approved under laboratory test conditions using American National Standards Institute standards. Ratings shown are for elevations up to 2000 feet. For elevations above 2000 feet, ratings should be reduced at the rate of 4% for each 1000 feet above sea level.

# Voyager 2 Packaged Gas / Electric General Data

**Table 9. General data—12½–15 tons high efficiency**

	12½ Tons Downflow and Horizontal Units		15 Tons Downflow and Horizontal Units	
	TH*150G3,4,W	YH*150G3,4,W	TH*180G3,4,W	YH*180G3,4,W
<b>Cooling Performance<sup>(a)</sup></b>				
Gross Cooling Capacity	152,400	152,400	180,500	180,500
EER <sup>(b)</sup>	12.1	12.1	12.1	12.1
Nominal CFM / AHRI Rated CFM	5,000 / 4,000	5,000 / 4,000	6,000 / 5,250	6,000 / 5,250
AHRI Net Cooling Capacity	144,000	144,000	174,000	174,000
Integrated Energy Efficiency Ratio (IEER) (One Speed Fan / Multi or Variable Speed Fan) <sup>(c)</sup>	13.5/15.0	13.5/15.0	14.0/15.0	14.0/15.0
Percent Capacity @ part load (Stage 1/Stage 2/Stage 3) <sup>(d)</sup>	30/70/100	30/70/100	32/68/100	32/68/100
System Power (kW)	11.90	11.90	14.38	14.38
<b>Compressor</b>				
Number/Type	2 / Scrolls	2 / Scrolls	2 / Scrolls	2 / Scrolls
<b>Sound</b>				
Outdoor Sound Rating (BELS) <sup>(e)</sup>	9.2	9.2	9.2	9.2
<b>Outdoor Coil</b>				
Type	Microchannel	Microchannel	Microchannel	Microchannel
Coil Width (in.)	1.0	1.0	1.0	1.0
Face Area (sq. ft.)	35.2	35.2	42.6	42.6
Rows/FPI	1 / 20	1 / 20	1 / 20	1 / 20
<b>Indoor Coil</b>				
Type	Hi-Performance	Hi-Performance	Hi-Performance	Hi-Performance
Tube Size (in.) ID	0.3125	0.3125	0.3125	0.3125
Face Area (sq. ft.)	26.00	26.00	31.42	31.42
Rows/FPI	4 / 15	4 / 15	4 / 15	4 / 15
Refrigerant Control	TXV	TXV	TXV	TXV
Drain Connection Number/Size (in.)	1/1.00 NPT	1/1.00 NPT	1/1.00 NPT	1/1.00 NPT
<b>Outdoor Fan</b>				
Type	Propeller	Propeller	Propeller	Propeller
Number Used/Diameter (in.)	2 / 26	2 / 26	2 / 26	2 / 26
Drive Type/No. Speeds	Direct / 1	Direct / 1	Direct / 1	Direct / 1
cfm	11,400	11,400	11,700	11,700
Number Motors/hp	2 / 0.50	2 / 0.50	2 / 0.50	2 / 0.50
Motor rpm	1,100	1,100	1,100	1,100
<b>Indoor Fan</b>				
Type	FC Centrifugal	FC Centrifugal	FC Centrifugal	FC Centrifugal
Number Used/Diameter (in.)	1 / 18x18	1 / 18x18	1 / 18x18	1 / 18x18
Drive Type/No. Speeds	Belt / 1	Belt / 1	Belt / 1	Belt / 1
Number Motors	1	1	1	1
Motor hp (Standard/Oversized)	3.0 / 5.0	3.0 / 5.0	3.0 / 5.0	3.0 / 5.0
Motor rpm (Standard/Oversized)	1,740 / 3,450	1,740 / 3,450	1,740 / 3,450	1,740 / 3,450
Motor Frame Size (Standard/Oversized)	145T / 145T	145T / 145T	145T / 145T	145T / 145T



# Voyager 2 Packaged Gas / Electric General Data

**Table 9. General data—12½–15 tons high efficiency (continued)**

	12½ Tons Downflow and Horizontal Units		15 Tons Downflow and Horizontal Units	
	TH*150G3,4,W	YH*150G3,4,W	TH*180G3,4,W	YH*180G3,4,W
<b>Filters</b>				
Type Furnished <sup>(f)</sup>	Throwaway	Throwaway	Throwaway	Throwaway
Number Size Recommended				
Downflow	(4)20x20x2 (4)20x25x2	(4)20x20x2 (4)20x25x2	(8)20x20x2 (4)20x16x2	(8)20x20x2 (4)20x16x2
Horizontal	(8)20x25x2	(8)20x25x2	(12)20x20x2	(12)20x20x2
<b>Refrigerant Charge (Pounds of R-410A) (g)</b>				
Downflow and Horizontal (Cir#1/Cir#2)	12.5/7.1	12.5/7.1	13.0/8.5	13.0/8.5
Optional Hot Gas Reheat Coil (Cir#1/Cir#2)	9.2 / 6.9	9.2 / 6.9	10.9 / 8.9	10.9 / 8.9

- (a) Cooling Performance is rated at 95°F ambient, 80°F entering dry bulb, 67°F entering wet bulb. Gross capacity does not include the effect of fan motor heat. AHRI capacity is net and includes the effect of fan motor heat. Units are suitable for operation to ±20% of nominal cfm. Certified in accordance with the Unitary Large Equipment Certification Program, which is based on AHRI Standard 340/360.
  - (b) EER is rated at AHRI conditions and in accordance with AHRI Standard 210/240 or 340/360.
  - (c) Integrated Energy Efficiency Ratio (IEER) is rated in accordance with AHRI standard 210/240 or 340/360.
  - (d) 3 stages not available with Reheat models.
  - (e) Outdoor Sound Rating shown is tested in accordance with AHRI Standard 270 or 370.
  - (f) An optional 2 inch pleated filter is also available.
  - (g) Refrigerant charge is an approximate value. For a more precise value, see unit nameplate and service instructions.
- \* Indicates both downflow and horizontal units.

**Table 10. General data—heating—12½-15 tons high efficiency**

	12½ Tons Downflow and Horizontal Units			15 Tons Downflow and Horizontal Units		
	Heating Performance <sup>(a)</sup> (Gas/Electric Only)					
Heating Models	Low	High	Modulating Turn Down = 2.5:1	Low	High	Modulating Turn Down = 2.5:1
<b>Heating Input (Btu/h)</b>	150,000	250,000	350,000	250,000	350,000	350,000
1st Stage (Btu)	100,000	175,000	140,000	175,000	250,000	140,000
<b>Heating Output (Btu/h)</b>	120,000	200,000	280,000	200,000	280,000	280,000
1st Stage (Btu)	80,000	140,000	112,000	140,000	200,000	112,000
<b>Steady State Efficiency%</b>	80	80	80	80	80	80
<b>No. Burners</b>	1	1	1	1	1	1
<b>No. Stages</b>	2	2	N/A	2	2	N/A
<b>Gas Supply Line Pressure (in. wc)</b>	2.5 / 14.0	2.5 / 14.0	2.5 / 14.0	2.5 / 14.0	2.5 / 14.0	2.5 / 14.0
Natural or LP (minimum/maximum)			Natural Only			Natural Only
<b>Gas Connection Pipe Size (in.)</b>	½	½	¾	½	¾	¾

- (a) Heating Performance limit settings and rating data were established and approved under laboratory test conditions using American National Standards Institute standards. Ratings shown are for elevations up to 2000 feet. For elevations above 2000 feet, ratings should be reduced at the rate of 4% for each 1000 feet above sea level.

# Voyager 2 Packaged Gas / Electric General Data

**Table 11. General data—17½–20 tons high efficiency**

	17½ Tons Downflow and Horizontal Units		20 Tons Downflow and Horizontal Units	
	TH*210G3,4,W	YH*210G3,4,W	TH*240G3,4,W	YH*240G3,4,W
<b>Cooling Performance<sup>(a)</sup></b>				
Gross Cooling Capacity	214,800	214,800	248,500	248,500
EER <sup>(b)</sup>	11.8	11.8	11.0	11.0
Nominal CFM / AHRI Rated CFM	7,000 / 5,600	7,000 / 5,600	8,000 / 6,400	8,000 / 6,400
AHRI Net Cooling Capacity	204,000	204,000	234,000	234,000
Integrated Energy Efficiency Ratio (IEER) (One Speed Fan / Multi or Variable Speed Fan) <sup>(c)</sup>	13.0/14.0	13.0/14.0	12.4/14.0	12.4/14.0
Percent Capacity @ part load (Stage 1/Stage 2/Stage 3) <sup>(d)</sup>	31/69/100	31/69/100	30/70/100	30/70/100
System Power (kW)	17.29	17.29	21.27	21.27
<b>Compressor</b>				
Number/Type	2 / Scrolls	2 / Scrolls	2 / Scrolls	2 / Scrolls
<b>Sound</b>				
Outdoor Sound Rating (BELS) <sup>(e)</sup>	9.2	9.2	9.4	9.4
<b>Outdoor Coil</b>				
Type	Microchannel	Microchannel	Microchannel	Microchannel
Coil Width (in.)	1.0	1.0	1.0	1.0
Face Area (sq. ft.)	42.6	42.6	42.6	42.6
Rows/FPI	1 / 20	1 / 20	1 / 20	1 / 20
<b>Indoor Coil</b>				
Type	Hi-Performance	Hi-Performance	Hi-Performance	Hi-Performance
Tube Size (in.) ID	0.3125	0.3125	0.3125	0.3125
Face Area (sq. ft.)	31.42	31.42	31.42	31.42
Rows/FPI	4 / 15	4 / 15	4 / 15	4 / 15
Refrigerant Control	TXV	TXV	TXV	TXV
Drain Connection Number/Size (in.)	1/1.00 NPT	1/1.00 NPT	1/1.00 NPT	1/1.00 NPT
<b>Outdoor Fan</b>				
Type	Propeller	Propeller	Propeller	Propeller
Number Used/Diameter (in.)	2 / 26	2 / 26	2 / 28	2 / 28
Drive Type/No. Speeds	Direct / 1	Direct / 1	Direct / 1	Direct / 1
cfm	15,800	15,800	16,500	16,500
Number Motors/hp	2 / 1.0	2 / 1.0	2 / 1.0	2 / 1.0
Motor rpm	1,125	1,125	1,125	1,125
<b>Indoor Fan</b>				
Type	FC Centrifugal	FC Centrifugal	FC Centrifugal	FC Centrifugal
Number Used/Diameter (in.)	1 / 18x18	1 / 18x18	1 / 18x18	1 / 18x18
Drive Type/No. Speeds	Belt / 1	Belt / 1	Belt / 1	Belt / 1
Number Motors	1	1	1	1
Motor hp (Standard/Oversized)	5.0 / 7.5	5.0 / 7.5	5.0 / 7.5	5.0 / 7.5
Motor rpm (Standard/Oversized)	3,450 / 3,470	3,450 / 3,470	3,450 / 3,470	3,450 / 3,470
Motor Frame Size (Standard/Oversized)	145T / 184T	145T / 184T	145T / 184T	145T / 184T

Light Commercial  
Voyager Packaged Systems

# Voyager 2 Packaged Gas / Electric General Data

**Table 11. General data—17½–20 tons high efficiency (continued)**

	17½ Tons Downflow and Horizontal Units		20 Tons Downflow and Horizontal Units	
	TH*210G3,4,W	YH*210G3,4,W	TH*240G3,4,W	YH*240G3,4,W
<b>Filters</b>				
Type Furnished <sup>(f)</sup>	Throwaway	Throwaway	Throwaway	Throwaway
Number Size Recommended				
Downflow	(8)20x20x2 (4)20x16x2	(8)20x20x2 (4)20x16x2	(8)20x20x2 (4)20x16x2	(8)20x20x2 (4)20x16x2
Horizontal	(12)20x20x2	(12)20x20x2	(12)20x20x2	(12)20x20x2
<b>Refrigerant Charge (Pounds of R-410A)<sup>(g)</sup></b>				
Downflow and Horizontal (Cir#1/Cir#2)	14.0 / 7.3	14.0 / 7.3	15.5 / 7.5	15.5 / 7.5
Optional Hot Gas Reheat Coil (Cir#1/Cir#2)	12.2/8.9	12.2/8.9	11.9 / 9.6	11.9 / 9.6

- (a) Cooling Performance is rated at 95°F ambient, 80°F entering dry bulb, 67°F entering wet bulb. Gross capacity does not include the effect of fan motor heat. AHRI capacity is net and includes the effect of fan motor heat. Units are suitable for operation to ±20% of nominal cfm. Certified in accordance with the Unitary Large Equipment Certification Program, which is based on AHRI Standard 340/360.
  - (b) EER is rated at AHRI conditions and in accordance with AHRI Standard 210/240 or 340/360.
  - (c) Integrated Energy Efficiency Ratio (IEER) is rated in accordance with AHRI standard 210/240 or 340/360.
  - (d) 3 stages not available with Reheat models.
  - (e) Outdoor Sound Rating shown is tested in accordance with AHRI Standard 270 or 370.
  - (f) An optional 2 inch pleated filter is also available.
  - (g) Refrigerant charge is an approximate value. For a more precise value, see unit nameplate and service instructions.
- \* Indicates both downflow and horizontal units.

**Table 12. General data—heating—17½–20 tons high efficiency**

	17½ Tons Downflow and Horizontal Units			20 Tons Downflow and Horizontal Units		
	Heating Performance <sup>(a)</sup> (Gas/Electric Only)					
Heating Models	Low	High	Modulating Turn Down = 2.5:1	Low	High	Modulating Turn Down = 2.5:1
<b>Heating Input (Btu/h)</b>	250,000	350,000	350,000	250,000	400,000	350,000
1st Stage (Btu)	175,000	250,000	140,000	175,000	300,000	140,000
<b>Heating Output (Btu/h)</b>	200,000	280,000	280,000	200,000	320,000	280,000
1st Stage (Btu)	140,000	200,000	112,000	140,000	240,000	112,000
<b>Steady State Efficiency%</b>	80	80	80	80	80	80
<b>No. Burners</b>	1	1	1	1	1	1
<b>No. Stages</b>	2	2	N/A	2	2	N/A
<b>Gas Supply Line Pressure (in. wc)</b>	2.5 / 14.0	2.5 / 14.0	2.5/14.0	2.5 / 14.0	2.5 / 14.0	2.5/14.0
Natural or LP (minimum/maximum)			Natural Only			Natural Only
<b>Gas Connection Pipe Size (in.)</b>	½	¾	¾	½	¾	¾

- (a) Heating Performance limit settings and rating data were established and approved under laboratory test conditions using American National Standards Institute standards. Ratings shown are for elevations up to 2000 feet. For elevations above 2000 feet, ratings should be reduced at the rate of 4% for each 1000 feet above sea level.

# Voyager 2 Packaged Gas / Electric General Data

**Table 13. General data—25 tons high efficiency**

	<b>25 Tons Downflow and Horizontal Units</b>	
	<b>TH*300G3,4,W</b>	<b>YH*300G3,4,W</b>
<b>Cooling Performance<sup>(a)</sup></b>		
Gross Cooling Capacity	292,300	292,300
EER <sup>(b)</sup>	10.6	10.6
Nominal CFM / AHRI Rated CFM	10,000 / 8,000	10,000 / 8,000
AHRI Net Cooling Capacity	274,000	274,000
Integrated Energy Efficiency Ratio (IEER) (One Speed Fan / Multi or Variable Speed Fan) <sup>(c)</sup>	12.4/15.0	12.4/15.0
Percent Capacity @ part load (Stage 1/Stage 2/Stage 3/Stage 4) <sup>(d)</sup>	25/50/75/100	25/50/75/100
System Power (kW)	25.85	25.85
<b>Compressor</b>		
Number <sup>(e)</sup> /Type	3 / Scrolls	3 / Scrolls
<b>Sound</b>		
Outdoor Sound Rating (BELS) <sup>(f)</sup>	9.4	9.4
<b>Outdoor Coil</b>		
Type	Microchannel	Microchannel
Coil Width (in.)	1.0	1.0
Face Area (sq. ft.)	42.58	42.58
Rows/FPI	1 / 20	1 / 20
<b>Indoor Coil</b>		
Type	Hi-Performance	Hi-Performance
Tube Size (in.) ID	0.3125	0.3125
Face Area (sq. ft.)	31.42	31.42
Rows/FPI	4 / 15	4 / 15
Refrigerant Control	TXV	TXV
Drain Connection Number/Size (in.)	1/1.00 NPT	1/1.00 NPT
<b>Outdoor Fan</b>		
Type	Propeller	Propeller
Number Used/Diameter (in.)	2 / 28	2 / 28
Drive Type/No. Speeds	Direct / 1	Direct / 1
cfm	16,500	16,500
Number Motors/hp	2 / 1.0	2 / 1.0
Motor rpm	1,125	1,125
<b>Indoor Fan</b>		
Type	FC Centrifugal	FC Centrifugal
Number Used/Diameter (in.)	1 / 18x18	1 / 18x18
Drive Type/No. Speeds	Belt / 1	Belt / 1
Number Motors	1	1
Motor hp (Standard)	7.5	7.5
Motor rpm (Standard)	3,470	3,470
Motor Frame Size (Standard)	184T	184T

Light Commercial  
Voyager Packaged Systems

# Voyager 2 Packaged Gas / Electric General Data

**Table 13. General data—25 tons high efficiency (continued)**

	25 Tons Downflow and Horizontal Units	
	TH*300G3,4,W	YH*300G3,4,W
<b>Filters</b>		
Type Furnished <sup>(9)</sup>	Throwaway	Throwaway
Number Size Recommended		
Downflow	(8)20x20x2 (4)20x16x2	(8)20x20x2 (4)20x16x2
Horizontal	(12)20x20x2	(12)20x20x2
<b>Refrigerant Charge (Pounds of R-410A)<sup>(h)</sup></b>		
Downflow and Horizontal (Cir#1/Cir#2)	11.8 / 10.6	11.8 / 10.6
Optional Hot Gas Reheat Coil (Cir#1/Cir#2)	12.7 / 11.4	12.7 / 11.4

- (a) Cooling Performance is rated at 95°F ambient, 80°F entering dry bulb, 67°F entering wet bulb. Gross capacity does not include the effect of fan motor heat. AHRI capacity is net and includes the effect of fan motor heat. Units are suitable for operation to ±20% of nominal cfm. Certified in accordance with the Unitary Large Equipment Certification Program, which is based on AHRI Standard 340/360.
- (b) EER is rated at AHRI conditions and in accordance with AHRI Standard 210/240 or 340/360.
- (c) Integrated Energy Efficiency Ratio (IEER) is rated in accordance with AHRI standard 210/240 or 340/360.
- (d) 3 and 4 stages not available with Reheat models.
- (e) 2 compressors for Reheat Model
- (f) Outdoor Sound Rating shown is tested in accordance with AHRI Standard 270 or 370.
- (g) An optional 2-inch pleated filter is also available.
- (h) Refrigerant charge is an approximate value. For a more precise value, see unit nameplate and service instructions.
- \* Indicates both downflow and horizontal units.

**Table 14. General data—heating—25 tons high efficiency**

	25 Tons Downflow and Horizontal Units		
	Heating Performance <sup>(a)</sup> (Gas/Electric Only)		
Heating Models	Low	High	Modulating Turn Down = 2.5:1
<b>Heating Input (Btu/h)</b>	250,000	400,000	350,000
1st Stage (Btu)	175,000	300,000	140,000
<b>Heating Output (Btu/h)</b>	200,000	320,000	280,000
1st Stage (Btu)	140,000	240,000	112,000
<b>Steady State Efficiency%</b>	80	80	80
<b>No. Burners</b>	1	1	1
<b>No. Stages</b>	2	2	N/A
<b>Gas Supply Line Pressure (in. wc)</b>	2.5 / 14.0	2.5 / 14.0	2.5/14.0
Natural or LP (minimum/maximum)			Natural Only
<b>Gas Connection Pipe Size (in.)</b>	½	¾	¾

- (a) Heating Performance limit settings and rating data were established and approved under laboratory test conditions using American National Standards Institute standards. Ratings shown are for elevations up to 2000 feet. For elevations above 2000 feet, ratings should be reduced at the rate of 4% for each 1000 feet above sea level.

# Voyager 2 Packaged Heat Pumps Application Considerations

---

Application of this product should be within the catalogued airflow and cooling considerations.

## Air-Fi® Wireless

Please refer to Air-Fi Network Design Installation, Operation, and Maintenance manual BAS-SVX55\*-EN for additional details on applications with factory installed wireless.

## Low Ambient Cooling

This Voyager line features, as a standard, low ambient cooling down to 0°F. Contact your local American Standard Representative for more assistance with low ambient cooling applications.

## Barometric Relief

This product line offers an optional barometric relief damper included in the downflow economizer accessory. This accessory consists of gravity dampers which open with increased pressure. As the building air pressure increases, the pressure in the unit return air section also increases, opening the dampers and relieving the conditioned space.

**Important:** *THE EFFECTIVENESS OF BAROMETRIC RELIEF DAMPER DURING ECONOMIZING OPERATION IS SYSTEM RELATED. PRESSURE DROP OF THE RETURN AIR SYSTEM SHOULD BE CONSIDERED TO CONTROL BUILDING PRESSURIZATION.*

## Power Exhaust Accessory

The power exhaust accessory is available on all downflow units. This accessory can be field installed and will assist in relieving a building's pressurization.

## Condensate Trap

The evaporator is a draw-thru configuration. A trap must be field provided prior to start-up on the cooling cycle.

## Clearance Requirements

The recommended clearances identified with unit dimensions should be maintained to assure adequate serviceability, maximum capacity and peak operating efficiency. Actual clearances which appear inadequate should be reviewed with the local American Standard sales personnel.

## Unit Pitch

These units have sloped condensate drain pans. Units must be installed level, any unit slope must be toward access side of unit.

## VariTrac

VariTrac is not recommended for SZ VAV and Multi-speed indoor fan applications.

# Voyager 2 Packaged Heat Pumps Selection Procedure

## Cooling Capacity

### Step 1

Calculate the building's total and sensible cooling loads at design conditions. Use the American Standard calculation form or any other standard accepted method.

### Step 2

Given the following building requirements:

- A. Electrical Characteristics: 460/60/3
- B. Summer Design Conditions: Entering Evaporator Coil: 80 DB/ 67 WB  
Outdoor Ambient: 95 DB
- C. Total Cooling Load: 172 MBh
- D. Sensible Cooling Load: 122 MBh
- E. Airflow: 6000 cfm
- F. External Static Pressure: 0.50 in. w.g.
- G. Rooftop - downflow configuration.
- H. Accessories, Economizer, Supplementary Electric Heat
- I. Heating Capacity 100 MBh  
460 volt/3 phase Electric Supplemental Heat - at 6000 cfm

Size the equipment using Table 5, p. 24. As a starting point, a rough determination of the size of the unit must be made. This selection will then be confirmed after examining the performance at the given conditions. Divide the total cooling load by nominal BTUH per ton (12 MBh per ton); then round up to the nearest unit size.  $172 \text{ MBh} / 12 \text{ MBh} = 14.33$  (approx. 15 tons.)

### Step 3

Table 5, p. 24 shows that a WSD180E4 has a gross cooling capacity of 186.2 MBh and 138.9 MBh sensible capacity at 95°F ambient and 6000 cfm with 80 DB/67 WB air entering the evaporator.

### To Find Capacity at Intermediate Conditions

When the design conditions are between two numbers that are in the capacity table, interpolation is required to approximate the capacity.

**Note:** *Extrapolation outside of the table conditions is not recommended.*

### Step 4

Verify that there will be enough capacity by determining net capacity. In order to select the correct unit which meets the building's requirements, the fan motor heat must be deducted from the gross cooling capacity. The amount of heat that the fan motor generates is dependent on the effort by the motor CFM and static pressure. To determine the total unit static pressure, add the following:

External Static: 0.50 in.

Standard Filter 1 in: 0.05 in. (from Table 14, p. 29)

Economizer Return Air: 0.04 in. (from Table 14, p. 29)

Electric Heater Size 18 kW: 0.06 in.

Total Static Pressure: 0.65 in.

**Note:** *The Evaporator Fan Performance Table 8, p. 27 has already accounted for the pressure drop for standard filters and wet coils.*

# Voyager 2 Packaged Heat Pumps Selection Procedure

---

Therefore, the actual Total Static Pressure is  $0.65 - 0.05 = 0.6$ . With 6000 CFM and 0.60 inches, Table 8, p. 27 shows 2.17 Bhp.

The note below Table 8, p. 27 gives a formula to calculate Fan Motor Heat:

$$3.15 \times \text{bhp} = \text{MBh}$$

$$3.15 \times 2.17 = 6.835 \text{ MBh}$$

Now subtracting the fan motor heat from the gross cooling capacity of the unit:

Net Total Cooling Capacity =

$$186.2 - 6.835 = 179.36 \text{ MBh}$$

Net Sensible Cooling Capacity =

$$138.9 - 6.385 = 132.065 \text{ MBh}$$

## Step 5

If the performance will not meet the required load of the building, try a selection at the next higher size unit.

## Heating Capacity

### Step 1

Calculate the building heating load using the American Standard calculation form or other standard accepted method.

### Step 2

Size the equipment using Table 16, p. 31 to match the heating loads at design conditions.

- A. Total Heating Load: 100 MBh
- B. Outdoor Ambient (Winter) 17 DB
- C. Indoor Return Temperature: 70 DB
- D. Airflow: 6000 CFM

Use the integrated portion of Table 16, p. 31 for the WSD180E4 to determine capacity at winter design conditions. The mechanical heating portion of the heat pump will provide 85.4 MBh.

### Step 3

Because 45 MBh is less than the building's required heating capacity at winter design conditions, a supplementary heater must be selected.

$$100.0 - 85.54 = 14.46 \text{ MBh}$$

From Table 19, p. 32, at 480 volts, the 18 kW Heater will be adequate to do the job.

$$18 \text{ kW} \quad 61 \text{ MBh}$$

From Table 19, p. 32 select heater AYDHTRK418A (18 kW 460/60/3).



# Voyager 2 Packaged Heat Pumps Model Number Description

## Digit 1 – Unit Type

W = Packaged Heat Pump, Electric Heat

## Digit 2 – Efficiency

S = Standard Efficiency

## Digit 3 – Airflow Configuration

D = Downflow  
H = Horizontal

## Digit 4, 5, 6 – Nominal Gross Cooling Capacity (MBh)

150 = 12½ Tons  
180 = 15 Tons  
240 = 20 Tons

## Digit 7 – Major Design Sequence

E = R-410A Refrigerant

## Digit 8 – Voltage Selection

3 = 208-230/60/3  
4 = 460/60/3  
W = 575/60/3

## Digit 9 – Unit Controls

R = Reliatel

## Digit 10 – Heating Capacity

0 = No Heat  
G = 18 kW Electric Heat  
N = 36 kW Electric Heat  
P = 54 kW Electric Heat  
R = 72 kW Electric Heat

## Digit 11 – Minor Design Sequence

## Digit 12, 13 – Service Sequence

## Digit 14 – Fresh Air Selection

0 = No Fresh Air  
D = Econ Dry Bulb w/ Barometric Relief<sup>1</sup>  
F = Econ Reference Enthalpy w/ Barometric Relief<sup>1</sup>  
H = Econ Comparative Enthalpy w/ Barometric Relief<sup>1</sup>  
K = Low Leak Econ w/ Barometric Relief<sup>1</sup>  
M = Low Leak Econ Reference Enthalpy w/ Barometric Relief<sup>1</sup>  
P = Low Leak Econ Comparative Enthalpy w/ Barometric Relief<sup>1</sup>

## Digit 15 – Supply Fan/Drive Type/Motor

0 = Standard Motor  
1 = Oversized Motor<sup>5</sup>  
3 = High Efficiency Motor<sup>5</sup>  
6 = Single Zone Variable Air Volume Standard Motor  
7 = Multi-Speed Standard Motor  
8 = Single Zone Variable Air Volume Oversized Motor  
9 = Multi-Speed Oversized Motor

A = Single Zone Variable Air Volume Standard Motor w/ Shaft Ground Ring  
B = Multi-Speed Standard Motor w/ Shaft Ground Ring  
C = Single Zone Variable Air Volume Oversized Motor w/ Shaft Ground Ring  
D = Multi-Speed Oversized Motor w/ Shaft Ground Ring

## Digit 16 – Hinged Service Access / Filters<sup>5</sup>

0 = Standard Panels/Standard Filters<sup>17</sup>  
A = Hinged Access/Standard Filters<sup>17</sup>  
B = Standard Panels/2" MERV 8 Filters  
C = Hinged Access/2" MERV 8 Filters  
D = Standard Panels/MERV 13 Filters  
E = Hinged Access/MERV 13 Filters

## Digit 17 – Condenser Coil Protection

0 = Standard Coil  
1 = Standard Coil With Hail Guard  
2 = Black Epoxy Pre-Coated Coil  
3 = Black Epoxy Pre-Coated Coil with Hail Guard

## Digit 18 – Through The Base Provisions

0 = No Through The Base Provisions  
A = Through The Base Electric<sup>11</sup>  
D = Through The Base Utilities Access

## Digit 19 – Disconnect Switch/Circuit Breaker<sup>10</sup>

0 = No Disconnect/circuit break  
1 = Unit Mounted Non-Fused Disconnect Switch  
2 = Unit Mounted Circuit Breaker

## Digit 20 – Convenience Outlet Option

0 = Without Convenience Outlet  
A = Unpowered Convenience Outlet<sup>4</sup>  
B = Powered Convenience Outlet<sup>4</sup>

## Digit 21 – Communications Options

0 = Without Communications Options  
1 = American Standard Communications Interface<sup>5, 13</sup>  
2 = LonTalk Communications Interface<sup>5</sup>  
6 = Building Automation Control Network Communications Interface  
7 = Air-Fi<sup>®</sup> Wireless Communications<sup>19</sup>

## Digit 22 – Refrigeration System Option

0 = Standard refrigeration system

## Digit 23 – Refrigeration Controls

0 = Without Refrigeration Controls  
1 = Frostat™

## Digit 24 – Smoke Detector<sup>2,9</sup>

0 = Without Smoke Detector  
A = Return Air Smoke Detector  
B = Supply Air Smoke Detector  
C = Return/Supply Air Smoke Detector  
D = Plenum Smoke Detector

## Digit 25 – System Monitoring Controls<sup>2</sup>

0 = No Monitoring Controls  
1 = Clogged Filter Switch  
2 = Fan Failure Switch  
3 = Discharge Air Sensing  
4 = Clogged Filter Switch and Fan Failure  
5 = Clogged Switch and Discharge Air Sensing  
6 = Fan Failure Switch and Discharge Air Sensing  
7 = Clogged Filter Switch, Fan Failure Switch and Discharge Air Sensing  
A = Condensate Drain Pan Overflow Switch  
B = Clogged Filter Switch and Condensate Drain Pan Overflow Switch  
C = Fan Failure Switch and Condensate Drain Pan Overflow Switch  
D = Discharge Air Sensing and Condensate Drain Pan Overflow Switch  
E = Clogged Filter Switch, Fan Failure Switch and Condensate Drain Pan Overflow Switch  
F = Clogged Filter Switch, Discharge Air Sensing Tube and Condensate Drain Pan Overflow Switch  
G = Fan Failure Switch, Discharge Air Sensing Tube and Condensate Drain Pan Overflow Switch  
H = Clogged Filter Switch, Fan Failure Switch, Discharge Air Sensing and Condensate Drain Pan Overflow Switch

## Digit 26 – System Monitoring Controls

0 = No Monitoring Controls  
A = Demand Control Ventilation (CO<sub>2</sub>)<sup>15</sup>  
B = FDD (Fault Detection and Diagnostics)  
C = FDD (Fault Detection Diagnostics) & Demand Control Ventilation (CO<sub>2</sub>)<sup>15</sup>

## Voyager 2 Packaged Heat Pumps Model Number Description

### Digit 27 - Unit Hardware Enhancements

- 0 = No Enhancements
- 1 = Stainless Steel Drain Pan

### Digit 28 - Short Circuit Current Rating

- 0 = Standard SCCR
- A = 65kA SCCR Option<sup>16</sup>

### Digit 31 - Advanced Unit Controls

- 0 = Standard Unit Controls
- 1 = Human Interface<sup>18</sup>

**Note:** Most Factory Installed Options available for Downflow Air Discharge units only. Please verify with ordering system for availability.

### Model Number Notes

1. Some field set up required.
2. Requires ReliaTel Options Module.
3. Requires Economizer.
4. Must be ordered with Through-the-Base Electrical option or Horizontal-Side Access and either Unit Mounted Disconnect or Circuit Breaker.
5. Available factory installed on downflow AND horizontal units. Verify with ordering system.
6. Cannot be fused.
7. Must be factory installed when using Through-the-Base Options.
8. ReliaTel Options Module is required when ordering the following accessories: Clogged Filter Switch, Fan Fail Switch, Condensate Overflow Switch, Discharge Air Sensing Kit, Froststat, Ventilation Override, and Smoke Detector.
9. Option cannot be ordered in conjunction with field installed economizer on downflow units. Must be factory installed. The return air smoke detector may not fit up or work properly on the Voyager units when used in conjunction with 3<sup>rd</sup> party accessories (such as bolt on heat wheels, economizers, and power exhaust). Do not order the return air smoke detectors when using this type of accessory.
10. Unit mounted disconnect and circuit breakers are mutually exclusive of each other.
11. Through-the-base electrical option or Horizontal-Side Access must be ordered with either unit mounted disconnect or circuit breaker. When adding heat, you must order American Standard Electric Heat.
12. All Factory Installed Options are Built-to-Order. Check order services for estimated production cycle.
13. TCI is for use with non-VariTrac systems and VariTrac systems.
14. For use with multi-speed and SZVAV units only.
15. Demand Control Ventilation Option includes wiring only. The CO<sub>2</sub> sensor is a field-installed only option.
16. 575 VAC option is 25kA.
17. Standard filters are not available with Low Leak Economizers.
18. Human Interface is standard with FDD (Fault Detection Diagnostics).
19. Must be used with BACnet<sup>®</sup> open protocol.

COPY

# Voyager 2 Packaged Heat Pumps General Data

**Table 3. General data – 12½ - 20 tons**

	<b>12½ Tons Downflow &amp; Horizontal Units</b>	<b>15 Tons Downflow &amp; Horizontal Units</b>	<b>20 Tons Downflow &amp; Horizontal Units</b>
	<b>WS*150E3,4,W</b>	<b>WS*180E3,4,W</b>	<b>WS*240E3,4,W</b>
<b>Cooling Performance<sup>(a)</sup></b>			
Gross Cooling Capacity	148,000	177,000	249,000
EER <sup>(b)</sup>	10.6	10.6	9.7
Nominal Airflow/AHRI Rated Airflow (CFM)	5000	6000 / 5300	8000 / 6400
AHRI Net Cooling Capacity	146,000	170,000	240,000
IEER <sup>(c)</sup> (One Speed Fan / Two or Variable Speed Fan)	12/13.5	12/13.5	11.5/12.0
System Power (kW)	13.77	16.04	25.47
<b>Heating Performance<sup>(a)</sup></b>			
High Temp. Btuh Rating	136,000	170,000	210,000
COP	3.2	3.2	3.2
System Power (kW)	12.46	15.57	19.23
Low Temp. Btuh Rating	75,000	90,000	120,000
COP	2.1	2.1	2.1
System Power (kW)	10.47	12.56	16.75
<b>Compressor</b>			
Number/Type	2 / Scrolls	2 / Scrolls	2 / Scrolls
<b>AHRI Sound Rating (BELS)<sup>(d)</sup></b>			
	9.2	9.2	9.4
<b>Outdoor Coil – Type</b>			
Refrigerant Control	Hi-Performance	Hi-Performance	Hi-Performance
Refrigerant Control	Expansion Valve	Expansion Valve	Expansion Valve
Tube Size (in.) OD	0.3125	0.3125	0.3125
Face Area (sq. ft.)	35.20	35.20	42.53
Rows/FPI	3 / 16	3 / 16	3 / 16
<b>Indoor Coil – Type</b>			
Refrigerant Control	Hi-Performance	Hi-Performance	Hi-Performance
Tube Size (in.) ID	0.3125	0.3125	0.3125
Face Area (sq. ft.)	26.00	26.00	31.42
Rows/FPI	3 / 15	4 / 15	4 / 15
Refrigerant Control	Short Orifice	Short Orifice	Short Orifice
Drain Connection Number/Size (in.)	1/1.00 NPT	1/1.00 NPT	1/1.00 NPT
<b>Outdoor Fan – Type</b>			
Refrigerant Control	Propeller	Propeller	Propeller
Number Used/Diameter (in.)	2 / 26	2 / 26	2 / 28
Drive Type/No. Speeds	Direct / 1	Direct / 1	Direct / 1
CFM	11,100	10,800	14,800
Number Motors/HP	2 / 0.5	2 / 0.5	2 / 1.0
Motor RPM	1,100	1,100	1,125

# Voyager 2 Packaged Heat Pumps General Data

**Table 3. General data — 12½ - 20 tons (continued)**

	<b>12½ Tons Downflow &amp; Horizontal Units</b>	<b>15 Tons Downflow &amp; Horizontal Units</b>	<b>20 Tons Downflow &amp; Horizontal Units</b>
	<b>WS*150E3,4,W</b>	<b>WS*180E3,4,W</b>	<b>WS*240E3,4,W</b>
<b>Indoor Fan - Type</b>	FC Centrifugal	FC Centrifugal	FC Centrifugal
Number Used/Diameter (in.)	1 / 18x18	1 / 18x18	1 / 18x18
Drive Type/No. Speeds	Belt / 1	Belt / 1	Belt / 1
Number Motors	1	1	1
Motor HP (Standard/Oversized)	3.0 / 5.0	3.0 / 5.0 or 7.5 <sup>(e)</sup>	5.0 / 7.5
Motor RPM (Standard/Oversized)	1740 / 3,450	1740 / 3,450	3450 / 3,470
Motor Frame Size (Standard/Oversized)	56HZ / 56HZ	184TZ / 56HZ or 184TZ	56HZ / 184T
<b>Filters - Type Furnished</b>	Throwaway	Throwaway	Throwaway
Number Size Recommended			
Downflow	(4)20x20x2 (4)20x25x2	(4)20x20x2 (4)20x25x2	(8)20x20x2 (4)20x16x2
Horizontal	(8)20x25x2	(8)20x25x2	(12)20x20x2
<b>Refrigerant Charge Pounds of R-410A<sup>(f)</sup></b>			
Downflow	14 / 14.5	16.5 / 15.9	20.0 / 20.7
Horizontal	13.2 / 13.3	17 / 15.9	

- (a) Cooling Performance is rated at 35°C (95°F) ambient, 26.7°C (80°F) entering dry bulb, 19.4°C (67°F) entering wet bulb. Heating Performance is rated at 20°C (68°F) ambient, 8.3°C (47°F) entering dry bulb, 6.1°C (43°F) entering wet bulb. Gross capacity does not include the effect of fan motor heat. AHRI capacity is net and includes the effect of fan motor heat. Units are suitable for operation to ±20% of nominal airflow. Rated in accordance with AHRI Standard 210/240 or 340/360.
- (b) EER is rated at AHRI conditions and in accordance with DOE test procedures.
- (c) Integrated Energy Efficiency Ratio (IEER) is rated in accordance with AHRI standard 210/240 or 360.
- (d) Sound Rating shown is tested in accordance with ARI Standard 270 or 370.
- (e) Offered only as a field installed accessory.
- (f) Refrigerant charge is an approximate value. For a more precise value, see unit nameplate and service instructions.

# Light Commercial Foundation Packaged Systems

---

## 3-5 Ton Cooling and Gas

Features and Benefits .....	LFOU-2
Application Considerations .....	LFOU-10
Selection Procedure .....	LFOU-11
Model Number Description .....	LFOU-13
General Data .....	LFOU-14

## 15-25 Ton Cooling and Gas

Features and Benefits .....	LFOU-16
Application Considerations .....	LFOU-24
Selection Procedure .....	LFOU-25
Model Number Description .....	LFOU-27
General Data .....	LFOU-28

# Foundation 3-5 Ton Cooling & Gas Features and Benefits

Foundation™ has features and benefits that make it first class in the light commercial rooftop market. Designed with input from field contractors and technicians, its convertible airflow and ease of installation are outstanding.

## Standard and Optional Features at a Glance

### Standard Features

- 2-inch throwaway filters
- 5kA SCCR (Short Circuit Current Rating)
- 5 year Limited Compressor Warranty
- 5 year Limited Heat Exchanger
- 1 year Limited Parts Warranty
- Belt Drive Motors
- Cleanable Condensate Drain Pan
- Colored and Numbered Wiring
- Convertible Airflow
- Cooling to 45°F
- Discharge Line Thermostat
- Electromechanical Controls
- Easy Access Low Voltage Terminal Board (LTB)
- Foil-Faced and Edge Captured Insulation
- High Pressure Cutout
- Liquid Line Refrigerant Drier
- Locking Safety Device with Anti-Short Cycle Timer
- Microchannel Type Condenser and Evaporator Coils
- Operating Charge of R-410A
- Phase Monitor
- Provisions for Through-the-Base Electrical
- Quick Access Panels
- Quick Adjust Fan Motor Mounting Plate
- Single Point Power
- Single Side Service
- Standardized Components
- Tubular Aluminized Steel heat Exchanger

### Factory Installed Options

- Complete Coat™ Microchannel Condenser Coil
- Stainless Steel Heat Exchanger with 10 Year Warranty

### Factory or Field Installed Options

- Barometric Relief<sup>1</sup> (Downflow Low Leak Economizer Only)
- Condensate Overflow Switch
- Economizer (Downflow)<sup>1</sup>
- Electric Heaters
- Low Leak Economizer with Fault Detection and Diagnostics and 5 Year Limited Warranty - Downflow
- Manual Outside Air Dampers
- Motorized Outside Air Dampers
- Oversized Motor
- Reference or Comparative Enthalpy Economizer

# Foundation 3-5 Ton Cooling & Gas Features and Benefits

- Through the Base Electrical Access
- Through the Base Gas Piping
- Unit Mounted Non-Fused Disconnect Switch<sup>2</sup>
- 2-inch MERV 13 throwaway Filters

## Field Installed Options

- Barometric Relief (Standard and Low Leak Economizer, Downflow and Horizontal Configuration)
- Crankcase Heater
- Demand Control Ventilation with CO<sub>2</sub> Sensor
- Economizer (Horizontal)
- Frostat™
- Low Ambient Kit
- Low Leak Economizer with Fault Detection and Diagnostics and 5 Year Limited Warranty - Horizontal
- LP Conversion Kit
- Powered Exhaust
- Remote Potentiometer
- Roof Curb
- Thermostat
- Tool-less Hail Guard

**Note:** Explanation of Notes located in "Model Number Description," p. 15.

## Other Benefits

- Cabinet Design Ensures Water Integrity
- Convertible Airflow - Downflow to Horizontal Airflow Configuration
- Ease of Service, Installation and Maintenance
- Mixed Model Build Enables "Fastest in the Industry" Ship Cycle Times
- Rigorous Testing
- Unmatched Product Support

## Outstanding Standard Features

### Colored and Numbered Wiring

Save time and money tracing wires and diagnosing the unit.

### Compressor

Foundation™ contains the best compressor technology available to achieve the highest possible performance.

### Controls—Electromechanical

This 24-volt control includes the control transformer and contactor pressure lugs for power wiring.

# Foundation 3-5 Ton Cooling & Gas Features and Benefits

## Convertible Units



Foundation 3-5 tons units ship in downflow configuration. Their convertible design makes it easy to convert them to a horizontal airflow configuration without any kit or tool.

## Discharge Line Thermostat

A bi-metal element discharge line thermostats installed as a standard feature on the discharge line of each system. This standard feature provides extra protection to the compressors against high discharge temperatures in case of loss of charge, extremely high ambient and other conditions which could drive the discharge temperature higher.

## Efficiency

Product efficiencies meet the requirements of ASHRAE 90.1 - 2016.

## Easy Access Low Voltage Terminal Board

Foundation™ Low Voltage Terminal Board is mounted outside the main electrical control cabinet. It is extremely easy to locate and attach the thermostat control wiring and also test operation of all unit functions. This is another cost and time saving installation feature.

## Foil Faced Insulation

All panels in the evaporator section of the unit have cleanable foil-faced insulation. All edges are either captured or sealed to ensure no insulation fibers get into the airstream.

## Heat Exchanger

The cabinet features a tubular heat exchanger in low and medium heat capacities. The heat exchanger is fabricated using aluminized steel burners and corrosion-resistant aluminized steel tubes as standard on all models. As part of the heat exchanger assembly, an induced draft blower is used to pull the gas mixture through the burner tubes. A direct spark ignition system, which doubles as a safety device to prove the flame, is used to ignite the gas mixture.

## Locking Safety Device with Anti-Short Cycle Timer

This device monitors compressor safety switch trips to prevent short cycling, protecting the compressor. A manual reset is required after a fourth safety switch trip within a 6 hour period.

## Low Ambient Cooling

All Foundation units have cooling capabilities down to 45°F as standard.

## Low Voltage Connections

The wiring of the low voltage connections to the unit and the thermostat is as simple as R-R, G-G, Y-Y, and W-W. This simplified system makes it easy for the installer to wire.



# Foundation 3-5 Ton Cooling & Gas Features and Benefits

## Microchannel Coils

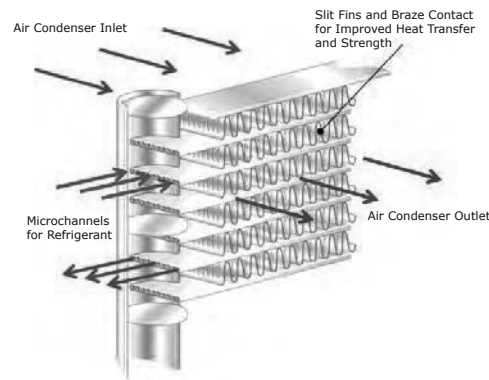

Microchannel coils are all-aluminum coils with fully-brazed construction. This design reduces risk of leaks and provides increased coil rigidity — making them more rugged on the jobsite. Their flat stream-lined tubes with small ports and metallurgical tube-to-fin bond allow for exceptional heat transfer.

Microchannel all-aluminum construction provides several additional benefits:

- Light weight (simplifies coil handling)
- Easy to recycle
- Minimize galvanic corrosion

## Motors

All indoor fan motors are belt drive as standard.

## Pressure Cutouts

Low and high pressure cutouts are standard on all Foundation™ models.

## Phase Monitor

Foundation features a three-phase line monitor module that protects against phase loss, phase reversal and phase unbalance. It is intended to protect compressors from reverse rotation. It has an operating input voltage range of 190–600 Vac, and LED indicators for ON and FAULT. There are no field adjustments and the module will automatically reset from a fault condition.

## Quick-Access Panels

Remove four or less screws for access to the standardized internal components and wiring.

## Quick-Adjust Fan Motor Mounting Plate

With the quick-adjust slider plate, the belt and sheaves can be quickly adjusted without moving the mounted fan motor. This results in reduced time spent on routine maintenance.

## Single Point Power

A single electrical connection powers the unit and all on-board options.

## Single Side Service

Single side service is standard on all units.

## Sloped Drain Pans

Every Foundation™ unit has a non-corrosive, sloped drain pan made of rigid PVC - standard on all units - that is removable for easy cleaning.

## Standardized Components

Components are placed in the same location on all Foundation units. Familiarize yourself with one Foundation and you are familiar with every Foundation. Due to standardized components throughout the Foundation line, contractors/owners can stock fewer parts.

# Foundation 3-5 Ton Cooling & Gas Features and Benefits

## Variety of Options<sup>1</sup>

### Factory Installed Options

#### Complete Coat™ Condenser Coil

The cathodic epoxy type electrodisposition coating is formulated for high edge build to a number of different types of heat exchangers. The coating is selected to provide excellent resistance and durability to corrosive effects of alkalis, acids, alcohols, petroleum, seawater, salt air, and corrosive environments.

#### Stainless Steel Heat Exchanger

The optional stainless steel heat exchanger is constructed of 409 stainless steel tubes and 439 stainless steel burners. It is resistant to corrosion and oxidation and easy to clean. The high strength to weight ratio allows for high ventilation rates with gas units and comes standard with a modulating gas heat option. With this option, a 10-year stainless steel heat exchanger warranty is standard.

### Factory or Field Installed Options

#### Barometric Relief

Barometric relief is an unpowered means of relieving excess building pressure.

**Note:** The factory installed barometric relief is for downflow low leak economizer units only.

#### Condensate Overflow Switch

A condensate overflow switch is available to shut the unit down in the event that the condensate drain line becomes clogged. This option protects the unit from water overflowing from the drain pan and entering the base of the units.

#### Disconnect Switch

This accessory can be utilized as a convenient way to stock standard product without a disconnect and have the ability to use the through the base/disconnect offering. The standard disconnect is non-fused, 3-pole, case molded switch.

#### Economizer - Downflow

Economizers are equipped with either dry bulb, reference, or comparative enthalpy sensing. These economizers provide free cooling as the outdoor temperature and/or humidity decreases. Correctly installed, they offer valuable energy savings. Factory-installed economizers save time and ensure proper installation.

**Note:** Factory-installed economizers require some field set-up.

#### Electric Heat

Electric heat is available as a factory or field installed option.

**Note:** For EBC036-060 cooling only units.

#### Low Leak Economizer with Fault Detection and Diagnostics - Downflow

This economizer meets the damper leakage requirements for ASHRAE 90.1, IECC, and California Title 24 standards (3 cfm/ft<sup>2</sup> at 1.0 in. w.g. for outside air dampers and 4 cfm/ft<sup>2</sup> for return dampers). Also, Fault Detection and Diagnostic information per California Title 24 is provided with this option. Barometric relief must be field installed with this option. Horizontal airflow configurations may only be field installed.

<sup>1</sup> Refer to "Model Number Description," p. 15 for option availability.

# Foundation 3-5 Ton Cooling & Gas Features and Benefits

## Manual Outside Air Damper

A 0–50 percent manual air damper is available.

## Motorized Outside Air Damper

A 0–50 percent motorized outside air dampers is available.

## Oversized Motors

Factory or field installed oversized motors are available for high static applications.

## Reference or Comparative Enthalpy

Measures and communicates humidity while maximizing comfort control.

## Through-the-Base Electrical Utility Access

An electrical service entrance shall be provided allowing access for both control and main power connections inside the curb and through the base of the unit. This option will allow for field installation of liquid-tight conduit and an external field installed disconnect switch.

Factory provided through the base openings simplify wiring and piping. Because these utility openings frequently minimize the number of roof penetrations, the integrity of roofing materials is enhanced.

## Through-the-Base Gas Piping (Gas Heat Units Only)

This option shall have all piping necessary including, black steel, manual gas shut-off valve, elbows, and union. This assembly will require minor field labor to install.

## Field Installed Options

### Barometric Relief

Designed to be used on downflow and horizontal configuration for both standard and low leak economizer units, barometric relief is an unpowered means of relieving excess building pressure.

### CO<sub>2</sub> Sensor - Demand Control Ventilation (DCV)

Demand-controlled ventilation (DCV) is a control strategy that responds to the actual demand (need) for ventilation by regulating the rate at which the HVAC system brings outdoor air into the building. A CO<sub>2</sub> sensor measures the concentration (parts per million, ppm) of CO<sub>2</sub> in the air. As the CO<sub>2</sub> concentration changes, the outside air damper modulates to meet the current ventilation needs of the zone. DCV is a passive system; direct control of the indoor fan is not possible with standard or low leak economizers. The CO<sub>2</sub> sensor kit is available as a field installed accessory.

### Crankcase Heaters

These band heaters provide improved compressor reliability by warming the oil to prevent migration during off-cycles or low ambient conditions.

### Economizer - Horizontal

Economizers are equipped with either dry bulb or reference or comparative enthalpy sensing. These economizers provide free cooling as the outdoor temperature and/or humidity decreases. Correctly installed, they offer a valuable energy savings.

### Frostat™

This switch, attached to the tube of the evaporator coil, monitors coil temperature to prevent evaporator icing and protect the compressor. Recommended for applications with low leaving air temperatures, low airflow and/or high latent load applications.

# Foundation 3-5 Ton Cooling & Gas Features and Benefits

## Low Ambient Kit

Allows system to operate in cooling below 45 degree by maintaining head pressure by cycling the outdoor fan motor allowing safe system operation without indoor coil icing.

## Low Leak Economizer with Fault Detection and Diagnostics - Horizontal

This economizer meets the damper leakage requirements for ASHRAE 90.1, IECC, and California Title 24 standards (3 cfm/ft<sup>2</sup> at 1.0 in. w.g. for outside air dampers and 4 cfm/ft<sup>2</sup> for return dampers). Also, Fault Detection and Diagnostic information per California Title 24 is provided with this option. Barometric relief must be field installed with this option. Horizontal airflow configurations may only be field installed.

## LP Conversion Kit

Provided for field conversion of gas heat units from natural gas to propane.

## Power Exhaust

This option is available on downflow units and provides exhaust of the return air, when using a downflow economizer, to maintain proper building pressurization. This is an excellent option for relieving most building overpressurization problems.

## Remote Potentiometer

When installed in the economizer control circuitry, this accessory provides a method to remotely adjust the minimum damper position.

## Roof Curbs

Available for downflow units.

## Thermostats

Available in programmable and non-programmable.

## Tool-less Hail Guards

Tool-less, hail protection quality coil guards shall be field-installed for condenser coil protection. This option protects the condenser coil from vandalism and/or hail damage.

## Other Benefits

### Cabinet Integrity

For added water integrity, Foundation has a raised 1-1/8" lip around the supply and return of the downflow units to prevent water from blowing into the ductwork.

### Easy to Install, Service and Maintain

Because today's owners are very cost-conscious when it comes to service and maintenance, Foundation was designed with direct input from service contractors. This valuable information helped to design a product that would get the service technician off the job quicker and save the owner money. Foundation does this by offering outstanding standard features enhanced by a variety of factory and field installed options, multiple control options, rigorously tested proven designs and superior product and technical support.

### Outstanding Adaptability

The Foundation 3-5 Tons units match the footprint of specific Carrier WeatherMaker units.

### Rigorous Testing

All of Foundation's designs were rigorously rain tested at the factory to ensure water integrity. Foundation units incorporate either a one piece top or the American Standard-Tite-Top (T3). Each part of the top

# Foundation 3-5 Ton Cooling & Gas Features and Benefits

---

overlaps in such a way that water cannot leak into the unit. These overlapped edges are gasketed and sealed to ensure superior water integrity.

Actual shipping tests were performed to determine packaging requirements. Units were test shipped around the country to determine the best packaging. Factory shake and drop tests were used as part of the package design process to help assure that the unit arrives at the job site in top condition.

Rigging tests include lifting a unit into the air and letting it drop one foot, assuring that the lifting lugs and rails hold up under stress. For the microchannel coils, the supplier will perform the leak check at 450 psig. The completely assembled refrigerant system is leak tested at a minimum of 225 psig with a refrigerant and nitrogen mixture.

All parts are inspected at the point of final assembly. Sub-standard parts are identified and rejected immediately. Every unit receives a 100% unit run test before leaving the production line to make sure it lives up to rigorous American Standard requirements.

## Unmatched Support

American Standard Sales Representatives are a Support Group that can assist you with:

- Product
- Application
- Service
- Training
- Special Applications
- Specifications
- Computer Programs and much more

# Foundation 3-5 Ton Cooling & Gas Application Considerations

Application of this product should be within the cataloged airflow and cooling considerations.

## Barometric Relief

This product line offers an optional barometric relief damper for use in conjunction with economizer option. This accessory consists of gravity dampers which open with increased pressure. As building pressure increases, the pressure in the unit return air section also increases, opening the dampers and relieving the conditioned space.

### Notes:

- *The effectiveness of barometric relief damper during economizing operation is system related.*
- *Pressure drop of the return air system should be considered to control building pressurization.*

## Clearance Requirements

The recommended clearances identified with unit dimensions should be maintained to ensure adequate serviceability, maximum capacity and peak operating efficiency. Actual clearances which appear inadequate should be reviewed with local American Standard sales personnel.

## Complete Coat™ Microchannel Condenser Coil

The cathodic epoxy type electrodisposition coating is formulated for high edge build to a number of different types of heat exchangers. The coating is selected to provide excellent resistance and durability to corrosive effects of alkalies, acids, alcohols, petroleum, seawater, salt air, and corrosive environments. This coating shall be available on microchannel condenser coils.

## Condensate Trap

The evaporator is a draw-through configuration. A trap must be field provided prior to start-up on the cooling cycle.

## Heating Operation

The heat exchanger is manufactured with aluminized steel. To prevent condensation within the heat exchanger, do not exceed 50 percent outside air or a minimum mixed air temperature of 40°F.

## Optional Stainless Steel Heat Exchanger

The optional stainless steel heat exchanger is manufactured with 409 stainless steel. To prevent corrosion and prolong heat exchanger reliability, the minimum mixed air temperature allowed across the heat exchanger is 40°F. The stainless steel heat exchanger option is an excellent option that compliments the dehumidification package and is used in conjunction with the modulating heat option. Whenever high outside air or outside applications exist, these options should be utilized.

## Low Ambient Cooling

The Foundation line features low ambient cooling down to 45°F. The following options need to be included/considered when low ambient applications are required: continuous fan operation, crankcase heaters, or low pressure bypass timer. Contact your local American Standard Representative for more assistance with low ambient cooling applications.

## Unit Pitch

These units have sloped condensate drain pans. Units must be installed level. Any unit slope must be toward access side of the unit.

# Foundation 3-5 Ton Cooling & Gas Selection Procedure

## Cooling Capacity

**Note:** Cooling Capacity Procedure is the same for cooling (E) and gas/electric (G).

### Step 1

Calculate the building's total and sensible cooling loads at design conditions. Use the following calculation methods or any other standard accepted method. Factors used in unit selection:

- Total Cooling Load: 61MBh
- Sensible Cooling Load: 45 MBh
- Airflow: 2000 cfm
- Electrical Characteristics: 460/60/3
- Summer Design Conditions: Entering Evaporator Coil: 80 DB, 67 WB Outdoor Ambient: 95 DB
- External Static Pressure: 0.36 in. wg
- Rooftop: downflow configuration
- Accessories:
  - Roof curb
  - Economizer
  - Electric Heat

### Step 2

As a starting point, a rough determination must be made of the size of the unit. The final selection will be made after examining the performance at the given conditions. Divide the total cooling load by nominal Btu/h per ton (12 MBh per ton); then round up to the nearest unit size.

$$61\text{MBh} / 12 \text{ MBh} = 5.0 \text{ tons}$$

### Step 3

Table 5, p. 20 shows that a EBC060A has a **gross** cooling capacity of 60.8 MBh and 47.8 MBh sensible capacity at 2000 cfm and 95 DB outdoor ambient with 80 DB, 67 WB air entering the evaporator.

#### To Find Capacity at Intermediate Conditions Not in the Table

When the design conditions are between values that are identified in the capacity table, interpolation is required to approximate the capacity.

**Note:** Extrapolation outside of the table conditions is not recommended.

### Step 4

In order to select the correct unit which meets the building's requirements, the fan motor heat must be deducted from the gross cooling capacity. The amount of heat that the fan motor generates is dependent on the effort by the motor—cfm and static pressure. To determine the total unit static pressure you add the external static pressure to the additional static related by the added features:

External Static Duct System: 0.36 in. wg

Standard Filter from Table 26, p. 39: 0.06 in. wg

Economizer from Table 26, p. 39 (100% Return Air): 0.07 in. wg

Electric Heater Size kW from Table 26, p. 39: 0.07 in. wg

(Reference "Heating Capacity," p. 14 for determination of heater size.) No additional static add for gas/heat exchanger.

# Foundation 3-5 Ton Cooling & Gas Selection Procedure

Total Static Pressure: 0.56 in. wg

**Note:** The Evaporator Fan Performance Table 18, p. 33 has already accounted for the pressure drop for standard filters and wet coils (see note below that table). Therefore, the actual total static pressure is  $0.56 - 0.06$  (from Table 26, p. 39) = 0.50 in. wg.

With 2000 cfm and 0.50 wg.

Table 18, p. 33 shows 0.81 bhp for this unit. Note below the table gives a formula to calculate Fan Motor Heat:  $2.8328 \times \text{Fan bhp} + 0.4714$ .

$2.8328 \times 0.81 + 0.4714 = 2.76 \text{ MBh}$

Now subtract the fan motor heat from the gross cooling capacity of the unit:

**Net** Total Cooling Capacity =  $60.8 \text{ MBh} - 2.76 = 58.04 \text{ MBh}$ .

**Net** Sensible Cooling Capacity =  $47.8 \text{ MBh} - 2.76 = 45.04 \text{ MBh}$ .

## Step 5

If the performance will not meet the required load of the building—total or sensible cooling load, try a selection at the next higher size unit.

## Heating Capacity

**Note:** Heating capacity procedures DIFFER for cooling (E) and gas/electric (G) units.

### Step 1

Calculate the building heating load.

### Step 2

Size the system heating capacity to match the calculated building heating load.

The electric heat accessory capacities are listed in Table 28, p. 40. From the table, a 10 kW heater will deliver 34.14 MBh at 480 volts. In order to determine capacity at 460 volts, the heater voltage correction factor from Table 29, p. 41 must be used. Therefore,  $34.14 \text{ MBh} \times 0.92$  (voltage correction factor) = 31.41 MBh.

## Air Delivery Selection

**Note:** Air Delivery procedures is the same for cooling (E) and gas/electric (G) units.

External static duct pressure drop through the air distribution system has been calculated to be 0.36 inches of water. From Table 26, p. 39 static pressure drop through the economizer is 0.07 and the 10kW heater is 0.07 inches of water.

Therefore the total static pressure is  $0.36 + 0.07 + 0.07 = 0.50$  inches.

Enter Table 18, p. 33 for a EBC060A4 at 2000 cfm and 0.50 static pressure. The standard motor at 948 rpm will give the desired airflow at a rated bhp of 0.81.



# Foundation 3-5 Ton Cooling & Gas Model Number Description

**Digit 1 – Unit Type**

- E = Packaged Cooling, Electric Heat
- G = Packaged Cooling, Gas Heat

**Digit 2 – Efficiency**

- B = ASHRAE 90.1 - 2016

**Digit 3 – Airflow Configuration**

- C = Convertible

**Digit 4, 5, 6 – Nominal Gross Cooling Capacity (MBh)**

- 036 = 3 Tons
- 048 = 4 Tons
- 060 = 5 Tons

**Digit 7 – Major Design Sequence**

- A

**Digit 8 – Voltage Selection**

- 3 = 208-230/60/3
- 4 = 460/60/3
- W = 575/60/3
- K = 380/60/3<sup>6, 7</sup>

**Digit 9 – Unit Controls**

- E = Electromechanical

**Digit 10 – Heating Capacity**

**Note:** (Applicable to Digit 1 = E models only)

- 0 = No Heat
- A = 4.7 kW Electric Heat
- B = 7.5 kW Electric Heat
- C = 10 kW Electric Heat
- D = 14.4 kW Electric Heat
- E = 20 kW Electric Heat
- F = 25 kW Electric Heat

**Note:** (Applicable to Digit 1 = G models only)

- L = Gas Heat - Low
- M = Gas Heat - Medium
- X = Gas Heat - SS Ht Ex - Low
- Y = Gas Heat - SS Ht Ex - Medium

**Digit 11 – Minor Design Sequence**

**Digit 12, 13 – Service Sequence**

- 00 = None

**Digit 14 – Fresh Air Selection<sup>3</sup>**

- 0 = No Fresh Air
- A = Manual Outside Air Damper 0-50%
- B = Motorized Outside Air Damper 0-50%
- C = Economizer, Dry Bulb 0-100% without Barometric Relief<sup>4</sup>
- E = Economizer, Reference Enthalpy 0-100% without Barometric Relief<sup>4</sup>
- G = Economizer, Comparative Enthalpy 0-100% without Barometric Relief<sup>4</sup>
- J = Downflow Low Leak Economizer, Dry Bulb w/o Barometric Relief<sup>4</sup>

- L = Downflow Low Leak Economizer, Reference Enthalpy w/o Barometric Relief<sup>4</sup>
- N = Downflow Low Leak Economizer, Comparative Enthalpy w/o Barometric Relief<sup>4</sup>

**Digit 15 – Supply Fan/Drive Type/Motor**

- 0 = Standard Motor
- 1 = Oversized Motor

**Digit 16 – Not Used**

**Digit 17 – Condenser Coil Protection**

- 0 = Standard Coil
- 4 = CompleteCoat™ Condenser Coil

**Digit 18 – Through The Base Provisions**

- Note:** Applicable to Digit 1, E models.
- 0 = No Through The Base Provisions
- A = Through The Base Electric

**Note:** Applicable to Digit 1, G models only.

- 0 = No Through The Base Provisions
- A = Through-The-Base Electric
- B = Through-The-Base Gas<sup>1</sup>
- C = Through-The-Base Electric/Gas

**Digit 19 – Disconnect Switch**

- 0 = No Disconnect
- 1 = Unit Mounted Non-Fused Disconnect Switch<sup>2</sup>

**Digit 20 – Not Used**

**Digit 21 – Not Used**

**Digit 22 – Not Used**

**Digit 23 – Not Used**

**Digit 24 – Not Used**

**Digit 25 - System Monitoring Controls**

- 0 = No Monitoring Controls
- A = Condensate Drain Pan Overflow Switch

**Digit 26 - System Monitoring Controls**

- 0 = No Economizer Fault Detection and Diagnostics (FDD)
- B = Economizer Fault Detection and Diagnostics (FDD)<sup>5</sup>

services for estimated production cycle.

4. Factory installed economizers only available in downflow configuration.
5. Fault Detection and Diagnostics (FDD) is available on Low Leak Economizers only.
6. Available on Digit 1 = E units only.
7. Unit will operate reliably at 400V.

**Model Number Notes**

1. Some field set up required.
2. Must be ordered with Through-the-Base Electrical option.
3. All Factory Installed Options are Built-to-Order. Check order

# Foundation 3-5 Ton Cooling & Gas General Data

**Table 1. General data — 3-5 tons**

	<b>3 Tons</b>	<b>4 Tons</b>	<b>5 Tons</b>
	<b>E/GBC036</b>	<b>E/GBC048</b>	<b>E/GBC060</b>
<b>Cooling Performance<sup>(a)</sup></b>			
Gross Cooling Capacity	37,000	51,100	59,000
EER <sup>(b)</sup>	12	12	12
Nominal Airflow CFM / AHRI Rated CFM	1200 / 1200	1600 / 1600	2000 / 1600
AHRI Net Cooling Capacity	36,000	49,500	57,500
Seasonal Energy Efficiency Ratio (SEER) <sup>(c)</sup>	14	14	14
System Power (kW)	3.00	4.13	4.79
<b>Compressor</b>			
Number/Type	1 / Scroll	1 / Scroll	1 / Scroll
<b>Sound</b>			
Outdoor Sound Rating (dBA) <sup>(d)</sup>	79	80	81
<b>Outdoor Coil</b>			
Type	Microchannel	Microchannel	Microchannel
Coil Width (in.)	0.63	0.63	1.0
Face Area (sq. ft.)	11.33	13.46	15.92
Rows/FPI	1 / 23	1 / 23	1 / 23
<b>Indoor Coil</b>			
Type	Microchannel	Microchannel	Microchannel
Coil Width (in.)	0.63	0.63	0.81
Face Area (sq. ft.)	6.44	6.44	6.44
Rows/FPI	2 / 16	2 / 16	2 / 16
Refrigerant Control	Thermal Expansion Valve	Thermal Expansion Valve	Thermal Expansion Valve
Drain Connection Number/Size (in.)	1 / 3/4-14 NPT female	1 / 3/4-14 NPT female	1 / 3/4-14 NPT female
<b>Outdoor Fan</b>			
Type	Propeller	Propeller	Propeller
Number Used/Diameter (in.)	1 / 23	1 / 23	1 / 23
Drive Type/No. Speeds	Direct / 1	Direct / 1	Direct / 1
cfm	4,000	4,000	4,000
Number Motors/hp	1 / 0.33	1 / 0.33	1 / 0.33
Motor rpm	1100	1100	1100
<b>Indoor Fan</b>			
Type	FC Centrifugal	FC Centrifugal	FC Centrifugal
Number Used/Diameter (in.)	1 / 11x11	1 / 11x11	1 / 11x11
Drive Type/No. Speeds	Belt / 1	Belt / 1	Belt / 1
Number Motors	1	1	1
Motor hp (Standard/Oversized)	1.0 / 2.0	1.0 / 2.0	1.0 / 2.0
Motor rpm (Standard/Oversized)	1750 / 1750	1750 / 1750	1750 / 1750
Motor Frame Size (Standard/Oversized)	56 / 56	56 / 56	56 / 56
<b>Filters</b>			
Type Furnished	Throwaway	Throwaway	Throwaway
Number Size Recommended	(4) 16x16x2	(4) 16x16x2	(4) 16x16x2
<b>Refrigerant Charge (Pounds of R-410A)<sup>(e)</sup></b>			
Circuit 1	3.5	3.7	5.0

(a) Cooling Performance is rated at 95°F ambient, 80°F entering dry bulb, 67°F entering wet bulb. Gross capacity does not include the effect of fan motor heat. ARI capacity is net and includes the effect of fan motor heat. Units are suitable for operation to ±20% of nominal cfm. Certified in accordance with the Unitary Air-Conditioner Equipment Certification Program, which is based on AHRI Standard 210/240.

(b) EER is rated at AHRI conditions and in accordance with AHRI Standard 210/240.

(c) Seasonal Energy Efficiency Ratio (SEER) is rated in accordance with AHRI standard 210/240 and DOE test procedures.

(d) Outdoor Sound Rating shown is tested in accordance with AHRI Standard 270.

(e) Refrigerant charge is an approximate value. For a more precise value, see unit nameplate and service instructions.

# Foundation 3-5 Ton Cooling & Gas General Data

**Table 2. General data—heating performance – 3-5 tons**

Heating Models	Heating Performance <sup>(a)</sup>					
	3 Tons		4 Tons		5 Tons	
	Low	Medium	Low	Medium	Low	Medium
<b>Heating Input (Btu/h)</b>	72,000	100,000	72,000	115,000	72,000	115,000
1st Stage (Btu)		80,000		92,000		92,000
<b>Heating Output (Btu/h)</b>	57,600	80,000	57,600	92,000	57,600	92,000
1st Stage (Btu)		64,000		73,600		73,600
<b>Steady State Efficiency%</b>	80%	80%	80%	80%	80%	80%
<b>No. Burners</b>	2	3	2	3	2	3
<b>No. Stages</b>	1	2	1	2	1	2
<b>Gas Supply Line Pressure (in. wc)</b>	4.0 / 14.0	4.0 / 14.0	4.0 / 14.0	4.0 / 14.0	4.0 / 14.0	4.0 / 14.0
Natural Gas (minimum/maximum)	11.0 / 14.0	11.0 / 14.0	11.0 / 14.0	11.0 / 14.0	11.0 / 14.0	11.0 / 14.0
<b>Gas Connection Pipe Size (in.)</b>	1/2"	1/2"	1/2"	1/2"	1/2"	1/2"

(a) Heating Performance limit settings and rating data were established and approved under laboratory test conditions using American National Standards Institute standards (ANSI). Ratings shown are for elevations up to 2000 feet. For elevations above 2000 feet, ratings should be reduced at the rate of 4% for each 1000 feet above sea level.

# Foundation 15-25 Ton Cooling & Gas Features and Benefits

Foundation™ has features and benefits that make it first class in the light commercial rooftop market. Designed with input from field contractors and technicians, its convertible airflow and ease of installation are outstanding.

## Standard and Optional Features at a Glance

### Standard Features

- 2-inch throwaway filters
- 5kA SCCR (Short Circuit Current Rating)
- 5 year Limited Compressor Warranty
- 5 year Limited Heat Exchanger (15–17½ ton); 1 Year on 20 and 25 Tons
- 1 year Limited Parts Warranty
- All Heat Capacities Available in Vertical and Horizontal Discharge Configurations
- Belt Drive Motors
- Cleanable Condensate Drain Pan
- Colored and Numbered Wiring
- Convertible Airflow
- Cooling to 45°F
- Crankcase Heater (15–20 Tons)
- Discharge Line Thermostat
- Electromechanical Controls
- Easy Access Low Voltage Terminal Board (LTB)
- Foil-Faced and Edge Captured Insulation
- Frostat™
- High Pressure Cutout
- Liquid Line Refrigerant Drier
- Locking Safety Device with Anti-Short Cycle Timer
- Low Pressure Cutout
- Microchannel Type Condenser Coils
- Operating Charge of R-410A
- Phase Monitor
- Provisions for Through-the-Base Electrical
- Quick Access Panels
- Quick Adjust Fan Motor Mounting Plate
- Single Point Power
- Single Side Service
- Standardized Components
- Tubular Aluminized Steel heat Exchanger

### Factory Installed Options

- Complete Coat™ Microchannel Condenser Coil
- Multi-Speed Indoor Fans (utilizing VFD)
- Stainless Steel Heat Exchanger with 10 Year Warranty
- Third Side Fork Access (Condenser)

### Factory or Field Installed Options

- Barometric Relief<sup>1</sup>
- Condensate Overflow Switch
- Economizer (Downflow)<sup>1</sup>
- Electric Heaters

# Foundation 15-25 Ton Cooling & Gas Features and Benefits

- Low Leak Economizer with Fault Detection and Diagnostics and 5 Year Limited Warranty - Downflow
- Manual Outside Air Dampers
- Motorized Outside Air Dampers
- Oversized Motor<sup>8</sup>
- Reference or Comparative Enthalpy Economizer
- Through the Base Electrical Access
- Through the Base Gas Piping
- Unit Mounted Non-Fused Disconnect Switch<sup>2</sup>

## Field Installed Options

- 2-inch MERV 13 Throwaway Filters
- Crankcase Heater (25 Tons)
- Demand Control Ventilation with CO<sub>2</sub> Sensor
- Economizer (Horizontal)
- Hail Guard
- High Altitude Kit
- High and Low Static Drive Kits
- Low Ambient Kit
- Low Leak Economizer with Fault Detection and Diagnostics and 5 Year Limited Warranty - Horizontal
- LP Conversion Kit
- Powered Exhaust
- Remote Potentiometer
- Roof Curb
- Thermostat

**Note:** Explanation of Notes located in "Model Number Description," p. 15.

## Other Benefits

- Cabinet Design Ensures Water Integrity
- Convertible Airflow - Downflow to Horizontal Airflow Configuration
- Ease of Service, Installation and Maintenance
- Mixed Model Build Enables "Fastest in the Industry" Ship Cycle Times
- Rigorous Testing
- Unmatched Product Support

## Outstanding Standard Features

### Colored and Numbered Wiring

Save time and money tracing wires and diagnosing the unit.

### Compressors

Foundation™ contains the best compressor technology available to achieve the highest possible performance. Dual stages from manifold compressors are outstanding for humidity control and part load cooling conditions.

### Controls—Electromechanical

This 24-volt control includes the control transformer and contactor pressure lugs for power wiring.

# Foundation 15-25 Ton Cooling & Gas Features and Benefits

## Convertible Units

Foundation units ship in the downflow configuration. A horizontal conversion kit, consisting of two downflow duct covers, is needed to convert the unit from a downflow to a horizontal airflow configuration. Units come complete with horizontal duct flanges so the contractor doesn't have to field fabricate them. These duct flanges are a time and cost saver. Units also have the ability to fit American Standard and other competitors roof curbs (Carrier). In a matter of minutes, you can go from the American Standard configuration to the Carrier configuration by simply changing the return air opening plate. This design allows for easy field conversion and eliminates the need for costly adapter curbs.



## Crankcase Heaters (15 - 20 Tons)

These band heaters provide improved compressor reliability by warming the oil to prevent migration during off-cycles or low ambient conditions.

## Discharge Line Thermostat

A bi-metal element discharge line thermostats installed as a standard feature on the discharge line of each compressor. This standard feature provides extra protection to the compressors against high discharge temperatures in case of loss of charge, extremely high ambient and other conditions which could drive the discharge temperature higher.

## Efficiency

Product efficiencies meet the requirements of ASHRAE 90.1.

## Easy Access Low Voltage Terminal Board

Foundation™ Low Voltage Terminal Board is mounted outside the main electrical control cabinet. It is extremely easy to locate and attach the thermostat control wiring and also test operation of all unit functions. This is another cost and time saving installation feature.

## Foil Faced Insulation

All panels in the evaporator section of the unit have cleanable foil-faced insulation. All edges are either captured or sealed to ensure no insulation fibers get into the airstream.

## Frostat™

This switch monitors coil temperature to prevent evaporator icing and protect the compressor.

## Heat Exchanger

The cabinet features a tubular heat exchanger in, low, medium and high heat capacities, all of which are available for both vertical as well as horizontal discharge directions. The heat exchanger is fabricated using aluminized steel burners and corrosion-resistant aluminized steel tubes as standard on all models. As part of the heat exchanger assembly, an induced draft blower is used to pull the gas mixture through the burner tubes. A direct spark ignition system, which doubles as a safety device to prove the flame, is used to ignite the gas mixture.

# Foundation 15-25 Ton Cooling & Gas Features and Benefits

## Locking Safety Device with Anti-Short Cycle Timer

This device monitors compressor safety switch trips to prevent short cycling, protecting the compressor. A manual reset is required after a fourth safety switch trip.

## Low Ambient Cooling

All Foundation units have cooling capabilities down to 45°F as standard.

## Low Voltage Connections

The wiring of the low voltage connections to the unit and the thermostat is as simple as R-R, G-G, Y-Y, and W-W. This simplified system makes it easy for the installer to wire.

## Microchannel Coils

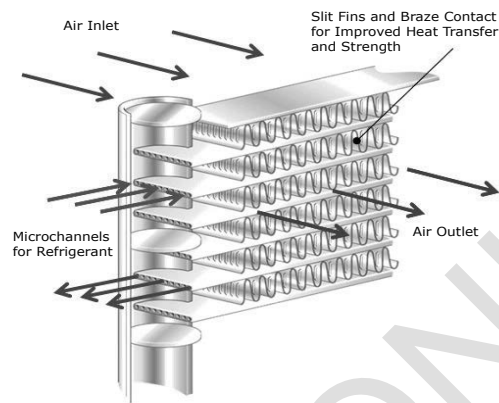

Microchannel coils are all-aluminum coils with fully-brazed construction. This design reduces risk of leaks and provides increased coil rigidity — making them more rugged on the jobsite. Their flat streamlined tubes with small ports and metallurgical tube-to-fin bond allow for exceptional heat transfer.

Microchannel all-aluminum construction provides several additional benefits:

- Light weight (simplifies coil handling)
- Easy to recycle
- Minimize galvanic corrosion

## Motors

All indoor fan motors are belt drive as standard.

## Pressure Cutouts

Low and high pressure cutouts are standard on all Foundation™ models.

## Phase Monitor

Foundation features a three-phase line monitor module that protects against phase loss, phase reversal and phase unbalance. It is intended to protect compressors from reverse rotation. It has an operating input voltage range of 180–632 Vac, and LED indicators for ON and FAULT. There are no field adjustments and the module will automatically reset from a fault condition.

## Quick-Access Panels

Remove three or less screws for access to the standardized internal components and wiring.

## Quick-Adjust Fan Motor Mounting Plate

With the quick-adjust slider plate, the belt and sheaves can be quickly adjusted without moving the mounted fan motor. This results in reduced time spent on routine maintenance.

## Single Point Power

A single electrical connection powers the unit and all on-board options.

## Single Side Service

Single side service is standard on all units.

# Foundation 15-25 Ton Cooling & Gas Features and Benefits

## Sloped Drain Pans

Every Foundation™ unit has a non-corrosive, sloped drain pan made of rigid PVC - standard on all units - that is removable for easy cleaning.

## Standardized Components

Components are placed in the same location on all Foundation units. Familiarize yourself with one Foundation and you are familiar with every Foundation. Due to standardized components throughout the Foundation line, contractors/owners can stock fewer parts.

## Variety of Options<sup>1</sup>

### Factory Installed Options

#### Complete Coat™ Condenser Coil

The cathodic epoxy type electrodisposition coating is formulated for high edge build to a number of different types of heat exchangers. The coating is selected to provide excellent resistance and durability to corrosive effects of alkalies, acids, alcohols, petroleum, seawater, salt air, and corrosive environments.

#### Multi-Speed Indoor Fan System

Multi-speed indoor fan system is designed for use in applications for meeting the minimum requirement of CA Title 24. This system incorporates a multi-speed fan control to change the speed of the fan to 67% of full airflow based off compressor stages.

#### Stainless Steel Heat Exchanger

The optional stainless steel heat exchanger is constructed of 304 stainless steel tubes and 439 stainless steel burners. It is resistant to corrosion and oxidation and easy to clean. The high strength to weight ratio allows for high ventilation rates with gas units and comes standard with a modulating gas heat option. With this option, a 10-year stainless steel heat exchanger warranty is standard.

#### Third Side Fork Access

This option adds fork openings on the condenser end of the unit for ease of maneuvering the unit through narrow openings.

### Factory or Field Installed Options

#### Barometric Relief

Designed to be used on downflow units, barometric relief is an unpowered means of relieving excess building pressure.

#### Condensate Overflow Switch

A condensate overflow switch is available to shut the unit down in the event that the condensate drain line becomes clogged. This option protects the unit from water overflowing from the drain pan and entering the base of the units.

#### Disconnect Switch

This accessory can be utilized as a convenient way to stock standard product without a disconnect and have the ability to use the through the base/disconnect offering. The standard disconnect is non-fused, 3-pole, case molded switch.

<sup>1</sup> Refer to "Model Number Description," p. 15 for option availability.



# Foundation 15-25 Ton Cooling & Gas Features and Benefits

## Economizer - Downflow

Economizers are equipped with either dry bulb, reference, or comparative enthalpy sensing. These economizers provide free cooling as the outdoor temperature and/or humidity decreases. Correctly installed, they offer valuable energy savings. Factory-installed economizers save time and ensure proper installation.

**Note:** *Factory-installed economizers require some field set-up.*

## Electric Heaters

Electric heat modules are available within the basic unit. If ordering the Through the Base Electrical option with an Electrical Heater, the heater must be factory installed.

## Low Leak Economizer with Fault Detection and Diagnostics - Downflow

This economizer meets the damper leakage requirements for ASHRAE 90.1, IECC, and California Title 24 standards (3 cfm/ft<sup>2</sup> at 1.0 in. w.g. for outside air dampers and 4 cfm/ft<sup>2</sup> for return dampers). Also, included as required per California Title 24:

- Fault Detection and Diagnostics system - provides detection of economizer faults. Barometric relief must be field installed with this option.
- Occupant Controlled Smart Thermostat (OCST) Connection - user-provided thermostat allows remote monitoring of economizer faults, and also provides the capability to receive load shedding commands from the utility company.

## Manual Outside Air Damper

A 0–25 percent manual air damper is available.

## Motorized Outside Air Damper

A 0–50 percent motorized outside air dampers is available.

## Oversized Motors

Factory or field installed oversized motors are available for high static applications.

**Note:** *Field installed oversized motor is not available with multispeed option.*

**Note:** *10 hp oversized motor is factory installed only.*

## Reference or Comparative Enthalpy

Measures and communicates humidity while maximizing comfort control.

## Through-the-Base Electrical Utility Access

An electrical service entrance shall be provided allowing access for both control and main power connections inside the curb and through the base of the unit. This option will allow for field installation of liquid-tight conduit and an external field installed disconnect switch.

Factory provided through the base openings simplify wiring and piping. Because these utility openings frequently minimize the number of roof penetrations, the integrity of roofing materials is enhanced.

## Through-the-Base Gas Piping (Gas Heat Units Only)

This option shall have all piping necessary including, black steel, manual gas shut-off valve, elbows, and union. This assembly will require minor field labor to install.

## Field Installed Options

### CO<sub>2</sub> Sensor - Demand Control Ventilation (DCV)

Demand-controlled ventilation (DCV) is a control strategy that responds to the actual demand (need) for ventilation by regulating the rate at which the HVAC system brings outdoor air into the

# Foundation 15-25 Ton Cooling & Gas Features and Benefits

building. A CO<sub>2</sub> sensor measures the concentration (parts per million, ppm) of CO<sub>2</sub> in the air. As the CO<sub>2</sub> concentration changes, the outside air damper modulates to meet the current ventilation needs of the zone. DCV is a passive system; direct control of the indoor fan is not possible with standard or low leak economizers. The CO<sub>2</sub> sensor kit is available as a field installed accessory.

## Crankcase Heaters (25 Tons)

These band heaters provide improved compressor reliability by warming the oil to prevent migration during off-cycles or low ambient conditions.

## Economizer - Horizontal

Economizers are equipped with either dry bulb or reference or comparative enthalpy sensing. These economizers provide free cooling as the outdoor temperature and/or humidity decreases. Correctly installed, they offer a valuable energy savings.

## High Altitude Kit

Requirement for units applies above 2000 feet. Derate gas orifices by 10%.

## Low Leak Economizer with Fault Detection and Diagnostics - Horizontal

This economizer meets the damper leakage requirements for ASHRAE 90.1, IECC, and California Title 24 standards (3 cfm/ft<sup>2</sup> at 1.0 in. w.g. for outside air dampers and 4 cfm/ft<sup>2</sup> for return dampers). Also, included as required per California Title 24:

- Fault Detection and Diagnostics system - provides detection of economizer faults. Barometric relief must be field installed with this option.
- Occupant Controlled Smart Thermostat (OCST) Connection - user-provided thermostat allows remote monitoring of economizer faults, and also provides the capability to receive load shedding commands from the utility company.

## LP Conversion Kit

Provided for field conversion of gas heat units from natural gas to propane.

## Power Exhaust

This option is available on downflow units and provides exhaust of the return air, when using a downflow economizer, to maintain proper building pressurization. This is an excellent option for relieving most building overpressurization problems.

## Remote Potentiometer

When installed in the economizer control circuitry, this accessory provides a method to remotely adjust the minimum damper position.

## Roof Curbs

Available for downflow units. Only one roof curb for the entire Foundation™ line simplifies curb selection.

## Static Drive Accessories

Available on many models, this high and low static drive accessories extend the capability of the standard motor. Avoid expensive motors by installing this optimized sheave accessory.

## Thermostats

Available in programmable and non-programmable.

# Foundation 15-25 Ton Cooling & Gas Features and Benefits

## Tool-less Hail Guards

Tool-less, hail protection quality coil guards (pictured right) shall be field-installed for condenser coil protection. This option protects the condenser coil from vandalism and/or hail damage.



## Other Benefits

### Cabinet Integrity

For added water integrity, Foundation has a raised 1-1/8 inch lip around the supply and return of the downflow units to prevent water from blowing into the ductwork.

### Easy to Install, Service and Maintain

Because today's owners are very cost-conscious when it comes to service and maintenance, Foundation was designed with direct input from service contractors. This valuable information helped to design a product that would get the service technician off the job quicker and save the owner money. Foundation does this by offering outstanding standard features enhanced by a variety of factory and field installed options, multiple control options, rigorously tested proven designs and superior product and technical support.

### Outstanding Flexibility

The Foundation unit has the ability to adapt to specific Carrier WeatherMaker™ models without costly adapter curbs. This will save contractors money and make the installation an ease.

### Rigorous Testing

All of Foundation's designs were rigorously rain tested at the factory to ensure water integrity. Foundation units incorporate either a one piece top or the American Standard-Tite-Top (T3). Each part of the top overlaps in such a way that water cannot leak into the unit. These overlapped edges are gasketed and sealed to ensure superior water integrity.

Actual shipping tests were performed to determine packaging requirements. Units were test shipped around the country to determine the best packaging. Factory shake and drop tests were used as part of the package design process to help assure that the unit arrives at the job site in top condition.

Rigging tests include lifting a unit into the air and letting it drop one foot, assuring that the lifting lugs and rails hold up under stress. For the microchannel coils, the supplier will perform the leak check at 450 psig. The completely assembled refrigerant system is leak tested at a minimum of 225 psig with a refrigerant and nitrogen mixture.

All parts are inspected at the point of final assembly. Sub-standard parts are identified and rejected immediately. Every unit receives a 100% unit run test before leaving the production line to make sure it lives up to rigorous American Standard requirements.

### Unmatched Support

American Standard Sales Representatives are a Support Group that can assist you with:

- Product
- Application
- Service
- Training
- Special Applications
- Specifications
- Computer Programs and much more

# Foundation 15-25 Ton Cooling & Gas Application Considerations

---

Application of this product should be within the cataloged airflow and cooling considerations.

## Barometric Relief

This product line offers an optional barometric relief damper for use in conjunction with economizer option. This accessory consists of gravity dampers which open with increased pressure. As building pressure increases, the pressure in the unit return air section also increases, opening the dampers and relieving the conditioned space.

### Notes:

- *The effectiveness of barometric relief damper during economizing operation is system related.*
- *Pressure drop of the return air system should be considered to control building pressurization.*

## Clearance Requirements

The recommended clearances identified with unit dimensions should be maintained to ensure adequate serviceability, maximum capacity and peak operating efficiency. Actual clearances which appear inadequate should be reviewed with local American Standard sales personnel.

## Complete Coat™ Microchannel Condenser Coil

The cathodic epoxy type electrodisposition coating is formulated for high edge build to a number of different types of heat exchangers. The coating is selected to provide excellent resistance and durability to corrosive effects of alkalis, acids, alcohols, petroleum, seawater, salt air, and corrosive environments. This coating shall be available on microchannel condenser coils.

## Condensate Trap

The evaporator is a draw-through configuration. A trap must be field provided prior to start-up on the cooling cycle.

## Heating Operation

The heat exchanger is manufactured with aluminized steel. To prevent condensation within the heat exchanger, do not exceed 50 percent outside air or a minimum mixed air temperature of 40°F.

## Optional Stainless Steel Heat Exchanger

The optional stainless steel heat exchanger is manufactured with 304 stainless steel tubes and 439 stainless steel burners. To prevent corrosion and prolong heat exchanger reliability, the minimum mixed air temperature allowed across the heat exchanger is 40°F. Whenever high outside air or outside applications exist, this option should be utilized.

## Low Ambient Cooling

The Foundation line features low ambient cooling down to 45°F. The following options need to be included/considered when low ambient applications are required: continuous fan operation, crankcase heaters, froststat. Contact your local American Standard Representative for more assistance with low ambient cooling applications.

## Unit Pitch

These units have sloped condensate drain pans. Units must be installed level. Any unit slope must be toward access side of the unit.

# Foundation 15-25 Ton Cooling & Gas Selection Procedure

## Cooling Capacity

**Note:** Cooling Capacity Procedure is the same for cooling (E) and gas/electric (G).

### Step 1.

Calculate the building's total and sensible cooling loads at design conditions. Use the following calculation methods or any other standard accepted method. Factors used in unit selection:

Total Cooling Load: 180 MBh

Sensible Cooling Load: 126 MBh

Airflow: 6000 cfm

Electrical Characteristics: 460/60/3

Summer Design Conditions: Entering Evaporator Coil: 80 DB, 67 WB Outdoor Ambient: 95 DB

External Static Pressure: 0.38 in. wg

Rooftop—downflow configuration

Accessories

- Roof curb
- Economizer
- Electric Heat

### Step 2.

As a starting point, a rough determination must be made of the size of the unit. The final selection will be made after examining the performance at the given conditions. Divide the total cooling load by nominal Btu/h per ton (12 MBh per ton); then round up to the nearest unit size.

$$180 \text{ MBh} / 12 \text{ MBh} = 15.0 \text{ tons}$$

### Step 3.

Table 3, p. 18 shows that a EBC180A4 has a **gross** cooling capacity of 187.2 MBh and 143 MBh sensible capacity at 6000 cfm and 95 DB outdoor ambient with 80 DB, 67 WB air entering the evaporator.

### To Find Capacity at Intermediate Conditions Not in the Table.

When the design conditions are between values that are identified in the capacity table, interpolation is required to approximate the capacity.

**Note:** Extrapolation outside of the table conditions is not recommended.

### Step 4.

In order to select the correct unit which meets the building's requirements, the fan motor heat must be deducted from the gross cooling capacity. The amount of heat that the fan motor generates is dependent on the effort by the motor—cfm and static pressure. To determine the total unit static pressure you add the external static pressure to the additional static related by the added features:

External Static Duct System	0.38 wg
Standard Filter 2 in. from Table 31, p. 43	0.05 wg
Economizer from Table 31, p. 43 (100% Return Air)	0.04 wg
Electric Heater Size 36 kW from Table 31, p. 43	0.07 wg
(Reference "Heating Capacity," p. 14 for determination of heater size.) No additional static add for gas/heat exchanger.	
<b>Total Static Pressure</b>	<b>0.55 wg</b>

### **Note:** The Evaporator Fan Performance

Table 9, p. 24 has already accounted for the pressure drop for standard filters and wet coils (see note below Table 9).

Therefore, the actual total static pressure is 0.55 - 0.05 (from Table 31, p. 43 = 0.50 wg).

# Foundation 15-25 Ton Cooling & Gas Selection Procedure

With 6000 cfm and 0.50 wg.

Table 9, p. 24 shows 1.37 bhp for this unit. Note below the table gives a formula to calculate Fan Motor Heat,

$$3.15 \times \text{bhp} = \text{MBh.}$$

$$3.15 \times 1.37 = 4.32 \text{ MBh.}$$

Now subtract the fan motor heat from the gross cooling capacity of the unit:

**Net Total Cooling Capacity**  
 $= 187.2 \text{ MBh} - 4.32 = 182.88 \text{ MBh.}$

**Net Sensible Cooling Capacity**  
 $= 143 \text{ MBh} - 4.32 = 138.68 \text{ MBh.}$

## Step 5.

If the performance will not meet the required load of the building—total or sensible cooling load, try a selection at the next higher size unit.

## Heating Capacity

**Note:** Heating capacity procedures DIFFER for cooling (E) and gas/electric (G) units.

### Step 1.

Calculate the building heating load.

### Step 2.

Size the system heating capacity to match the calculated building heating load. The following are building heating requirements:

460 volt/3 phase Power Supply  
 Total heating load of 115.0 MBh  
 6000 cfm

The electric heat accessory capacities are listed in Table 33, p. 44. From the table, a 36 kW heater will deliver 122.94 MBh at 480 volts. In order to determine capacity at 460 volts, the heater voltage correction factor from Table 34, p. 44 must be used. Therefore,  $122.94 \text{ MBh} \times 0.94$  (voltage correction factor) = 115.6 MBh.

Gas/electric: Fuel natural gas total heating load of 195 MBh. Table 32, p. 43 shows 250 MBh and 350 MBh input models. The output capacities of these furnaces are 203 MBh and 284 MBh respectively. The low heat model with 203 MBh output best matches the building requirements.

## Air Delivery Selection

**Note:** Air Delivery procedures is the same for cooling (E) and gas/electric (G) units.

External static pressure drop through the air distribution system has been calculated to be 0.50 inches of water. From Table 31, p. 43 static pressure drop through the economizer is 0.04 and the 36 kW heater is 0.07 inches of water ( $0.38 + 0.04 + 0.07$ ). Enter Table 9, p. 24 for a EBC180A4 at 6000 cfm and 0.50 static pressure. The standard motor with the low static drive accessory at 622 rpm will give the desired airflow at a rated bhp of 1.37.

# Foundation 15-25 Ton Cooling & Gas Model Number Description

## Digit 1 – Unit Type

- E = Packaged Cooling, Electric Heat
- G = Packaged Gas/Electric

## Digit 2 – Efficiency

- B = ASHRAE 90.1 - 2013

## Digit 3 – Airflow Configuration

- C = Convertible

## Digit 4, 5, 6 – Nominal Gross Cooling Capacity (MBh)

- 180 = 15 Tons
- 210 = 17½ Tons
- 240 = 20 Tons
- 300 = 25 Tons

## Digit 7 – Major Design Sequence

- A

## Digit 8 – Voltage Selection

- 3 = 208-230/60/3
- 4 = 460/60/3
- W = 575/60/3
- K = 380/60/3<sup>6, 7</sup>

## Digit 9 – Unit Controls

- E = Electromechanical

## Digit 10 – Heating Capacity

**Note:** (Applicable to Digit 1 = E models only)

- 0 = No Heat
- G = 18 kW Electric Heat
- N = 36 kW Electric Heat
- P = 54 kW Electric Heat
- R = 72 kW Electric Heat

**Note:** (Applicable to Digit 1 = G models only)

- H = Gas Heat - High
- L = Gas Heat - Low
- M = Gas Heat - Medium
- X = Gas Heat - SS Ht Ex - Low
- Y = Gas Heat - SS Ht Ex - Medium
- Z = Gas Heat - SS Ht Ex - High

## Digit 11 – Minor Design Sequence

## Digit 12, 13 – Service Sequence

- 00 = None

## Digit 14 – Fresh Air Selection<sup>3</sup>

- 0 = No Fresh Air
- A = Manual Outside Air Damper 0-25%
- B = Motorized Outside Air Damper 0-50%
- C = Economizer, Dry Bulb 0-100% without Barometric Relief<sup>4</sup>
- D = Economizer, Dry Bulb 0-100% with Barometric Relief<sup>1, 4</sup>
- E = Economizer, Reference Enthalpy 0-100% without Barometric Relief<sup>4</sup>
- F = Economizer, Reference Enthalpy 0-100% with Barometric Relief<sup>1, 4</sup>

- G = Economizer, Comparative Enthalpy 0-100% without Barometric Relief<sup>4</sup>
- H = Economizer, Comparative Enthalpy 0-100% with Barometric Relief<sup>1, 4</sup>
- J = Downflow Low Leak Economizer, Dry Bulb w/o Barometric Relief<sup>4</sup>
- L = Downflow Low Leak Economizer, Reference Enthalpy w/o Barometric Relief<sup>4</sup>
- N = Downflow Low Leak Economizer, Comparative Enthalpy w/o Barometric Relief<sup>4</sup>

## Digit 15 – Supply Fan/Drive Type/Motor

- 0 = Standard Motor
- 1 = Oversized Motor<sup>8</sup>
- 7 = Multi-Speed Standard Motor
- 9 = Multi-Speed Oversized Motor

## Digit 16 – Access

- 0 = Standard Fork Access
- F = Third Side Condenser Fork Access (15-25 Ton)

## Digit 17 – Condenser Coil Protection

- 0 = Standard Coil
- 4 = CompleteCoat™ Condenser Coil

## Digit 18 – Through The Base Provisions

**Note:** Applicable to Digit 1, E models.

- 0 = No Through The Base Provisions
- A = Through The Base Electric

**Note:** Applicable to Digit 1, G models only.

- 0 = No Through The Base Provisions
- A = Through The Base Electric
- B = Through-the-Base Gas<sup>1</sup>
- C = Through-the-Base Electric/Gas

## Digit 19 – Disconnect Switch

- 0 = No Disconnect
- 1 = Unit Mounted Non-Fused Disconnect Switch<sup>2</sup>

## Digit 20– Not Used

## Digit 21– Not Used

## Digit 22– Not Used

## Digit 23– Not Used

## Digit 24– Not Used

## Digit 25 - System Monitoring Controls

- 0 = No Monitoring Controls
- A = Condensate Drain Pan Overflow Switch

## Digit 26

- B = Economizer Fault Detection and Diagnostics (FDD)<sup>5</sup>

## Model Number Notes

1. Some field set up required.
2. Must be ordered with Through-the-Base Electrical option.
3. All Factory Installed Options are Built-to-Order. Check order services for estimated production cycle.
4. Factory installed economizers only available in downflow configuration.
5. Fault Detection and Diagnostics (FDD) is available on Low Leak Economizers only.
6. Available on Digit 1 = E units only.
7. Unit will operate reliably at 400V.
8. 10 hp oversized motor is factory installed only.

# Foundation 15-25 Ton Cooling & Gas General Data

**Table 1. General data – 15-25 tons**

	15 Ton	17½ Ton	20 Ton	25 Ton	
	E/GBC180	E/GBC210	E/GBC240	EBC300	GBC300
<b>Cooling Performance<sup>(a)</sup></b>					
Gross Cooling Capacity	180,000	212,000	256,000	284,000	284,000
EER (Downflow/Horizontal)	11	11	10	10	9.8
Nominal Airflow CFM / AHRI Rated CFM	6000 / 4800	7000 / 6650	8000 / 7000	10,000 / 8000	10,000 / 8000
AHRI Net Cooling Capacity	176,000	206,000	244,000	268,000	268,000
Integrated Energy Efficiency Ratio (IEER) (One Speed Fan / Multi Speed Fan)	12.4 / 13.2	12.4 / 13.2	11.6 / 12.4	11.6 / 12.4	11.4 / 12.4
Percent Capacity @ part load (Stage 1/Stage 2)	53 / 100	50 / 100	54 / 100	53 / 100	53 / 100
System Power (kW)	16.00	18.73	24.4	26.8	27.35
<b>Compressor</b>					
Number/Type	2 / Scrolls	2 / Scrolls	2 / Scrolls	2 / Scrolls	2 / Scrolls
<b>Sound</b>					
Outdoor Sound Rating (BELS)	9.5	9.5	9.5	9.5	9.5
<b>Outdoor Coil</b>					
Type	Microchannel	Microchannel	Microchannel	Microchannel	Microchannel
Coil Width (in.)	0.71	1.0	1.0	1.0	1.0
Face Area (sq. ft.)	34.74	34.74	34.74	34.74	34.74
Rows/FPI	1 / 23	1 / 21	1 / 23	1 / 23	1 / 23
<b>Indoor Coil</b>					
Type	Microchannel	Microchannel	Microchannel	Microchannel	Microchannel
Tube Size (in.) ID	1	1	1	1	1
Face Area (sq. ft.)	26.00	26.00	26.00	26.00	26.00
Rows/FPI	2 / 18	2 / 18	2 / 18	4 / 15	4 / 15
Refrigerant Control	TXV	TXV	TXV	TXV	TXV
Drain Connection Number/Size (in.)	1 / 1.00 PVC Pipe Female	1 / 1.00 PVC Pipe Female	1 / 1.00 PVC Pipe Female	1 / 1.00 PVC Pipe Female	1 / 1.00 PVC Pipe Female
<b>Outdoor Fan</b>					
Type	Propeller	Propeller	Propeller	Propeller	Propeller
Number Used/Diameter (in.)	2 / 28	2 / 28	2 / 28	2 / 28	2 / 28
Drive Type/No. Speeds	Direct / 1	Direct / 1	Direct / 1	Direct / 1	Direct / 1
cfm	15,900	15,900	15,900	15,900	15,900
Number Motors/hp	2 / 1.0	2 / 1.0	2 / 1.0	2 / 1.0	2 / 1.0
Motor rpm	1125	1125	1125	1125	1125
<b>Indoor Fan</b>					
Type	FC Centrifugal	FC Centrifugal	FC Centrifugal	FC Centrifugal	FC Centrifugal
Number Used/Diameter (in.)	2 / 15x15	2 / 15x15	2 / 15x15	2 / 15x15	2 / 15x15
Drive Type/No. Speeds	Belt / 1	Belt / 1	Belt / 1	Belt / 1	Belt / 1
Number Motors	1	1	1	1	1
Motor hp (Standard/Oversized)	3.0 <sup>(b)</sup> / 5.0	5.0 / 7.5	5.0 / 7.5	7.5 / 10.0 <sup>(c)</sup>	7.5 / 10.0 <sup>(c)</sup>
Motor rpm (Standard/Oversized)	1750 (380V = 3450) / 3450	3450 / 3450 (380V = 3470)	3450 / 3450 (380V = 3470)	3450 (380V = 3470) / 1750	3450 (380V = 3470) / 1750
Motor Frame Size (Standard/Oversized)	145T / 145T	145T / 184T	145T / 184T	184T / 215T	184T / 215T

Light Commercial  
Foundation Packaged Systems



# Foundation 15-25 Ton Cooling & Gas General Data

**Table 1. General data – 15-25 tons (continued)**

	15 Ton	17½ Ton	20 Ton	25 Ton	
	E/GBC180	E/GBC210	E/GBC240	EBC300	GBC300
<b>Filters</b>					
Type Furnished <sup>(d)</sup>	Throwaway	Throwaway	Throwaway	Throwaway	Throwaway
Number Size Recommended	(8) 20x25x2	(8) 20x25x2	(8) 20x25x2	(8) 20x25x2	(8) 20x25x2
<b>Refrigerant Charge (Pounds of R-410A)<sup>(e)</sup></b>					
Circuit 1	14.6	15.2	16.5	17.8	17.8

- (a) Units are AHRI Certified to AHRI Standard 340-360 (I-P). Rating conditions are 95F outdoor air temperature, 80F entering dry bulb, 67F entering wet bulb with minimum external static pressure as determined by rating standard.
- (b) 3.0hp motor is not available on 380V units.
- (c) 10.0hp oversized motor is not available on 380V units.
- (d) Optional field-installed MERV 13 filters available.
- (e) Refrigerant charge is an approximate value. For a more precise value, see unit nameplate and service instructions.

**Table 2. General data – heating performance – 15-25 tons**

	Heating Performance <sup>(a)</sup>					
	15 Tons			17½ - 25 Tons		
	Low	Medium	High	Low	Medium	High
<b>Heating Models</b>						
<b>Heating Input (Btu/h)</b>	240,000	320,000	350,000	240,000	320,000	400,000
1st Stage (Btu)	168,000	224,000	245,000	168,000	224,000	280,000
<b>Heating Output (Btu/h)</b>	192,000	256,000	280,000	192,000	256,000	320,000
1st Stage (Btu)	134,500	179,200	196,000	134,500	179,200	224,000
<b>Steady State Efficiency%</b>	80%	80%	80%	80%	80%	80%
<b>No. Burners</b>	6	8	8	6	8	8
<b>No. Stages</b>	2	2	2	2	2	2
<b>Gas Supply Line Pressure (in. wc)</b>						
Natural Gas (minimum/maximum)	4.5 / 14.0 in. wc.	4.5 / 14.0 in. wc.	5.0 / 14.0 in. wc.	4.5 / 14.0 in. wc.	4.5 / 14.0 in. wc.	5.5 / 14.0 in. wc.
LP (minimum/maximum)	11.0/14.0 in. wc.	11.0/14.0 in. wc.	11.0/14.0 in. wc.	11.0/14.0 in. wc.	11.0/14.0 in. wc.	11.0/14.0 in. wc.
<b>Gas Connection Pipe Size (in.)</b>	3/4"	3/4"	3/4"	3/4"	3/4"	3/4"

- (a) Heating Performance limit settings and rating data were established and approved under laboratory test conditions using American National Standards Institute standards (ANSI). Ratings shown are for elevations up to 2000 feet. For elevations above 2000 feet, ratings should be reduced at the rate of 4% for each 1000 feet above sea level.

# Light Commercial Odyssey Split Systems

---

Features and Benefits .....	LODY-2
Accessories .....	LODY-9
Application Considerations .....	LODY-14

## Split System Cooling

Selection Procedure .....	LODY-16
Model Number Description .....	LODY-18
General Data .....	LODY-20

## Split System Heat Pumps

Selection Procedure .....	LODY-26
Model Number Description .....	LODY-28
General Data .....	LODY-30

ONLINE ONLY COPY

# Odyssey Split Systems Features and Benefits

---

Unlike typical split systems on the market, Odyssey offers easy servicing, built-in reliability, ease of installation and outstanding customer service. And because today's owners are very cost-conscious when it comes to service and maintenance, the Odyssey Split System was designed with direct input from service contractors. This valuable information helped to design a product that would get the service person off the job quicker and save the owner money.

## Flexible Applications

Odyssey offers outstanding standard features enhanced by a variety of factory and field installed options, multiple control options, rigorously tested proven designs and superior product and technical support. Because of this, Odyssey offers ultimate flexibility. Units are built to order in our standard "shortest in the industry" ship cycle time. Odyssey is available with single, dual and manifolded compressor options. Single compressor outdoor units feature a single refrigeration circuitry, lowering job installation costs by requiring only one set of refrigerant lines.

Equally important, Odyssey offers single refrigerant circuit/capacity unloading models. The unloading units feature dual manifolded scroll compressors with two stages of capacity modulation and a single refrigeration circuit. Dual compressor/dual circuit models give true stand-by protection - if one compressor fails, the second will automatically start-up. Also, the first compressor can be serviced without shutting down the unit since the refrigerant circuits are independent. Dual compressor models also save on energy costs. During light load conditions, only one compressor will operate to save energy.

On select air handlers, a factory installed variable frequency drive (VFD) is available. These 2-Speed and Single Zone VAV (SZVAV) solutions, combined with condensing units that have multiple compressors, provide increased part load performance (IEER) when conditions are not at the max design condition. Additionally, some states have adopted codes that require this type of performance. Odyssey units are built with installation in mind. With a smaller footprint, the outdoor unit takes up less space and weighs less, making its installation more efficient and economical. Our indoor air handlers are built to be installed in confined spaces, fitting through standard doorways and freight elevators.

## Unmatched Product Support

One of our finest assets, American Standard Sales Representatives are a support group that can assist you with:

- Product
- Application
- Service
- Training
- Special Applications
- Specifications
- Computer Programs and much more

## Rigorous Testing

Our units are rigorously rain tested to ensure water integrity. Actual shipping tests are performed to determine packaging requirements. Units are test shipped around the country to determine the best packaging. Factory shake and drop tests are used as part of the package design process to help assure that the unit arrives at the job site in top condition. Rigging tests include lifting a unit into the air and letting it drop one foot, assuring that the lifting lugs and rails hold up under stress. A 100% coil leak test is performed at the factory. The condenser coils are leak tested at 660 psig and evaporators to 450 psig. All parts are inspected at the point of final assembly. Sub-standard parts are identified and rejected immediately. Every unit receives a 100% unit run test before leaving the production line to ensure it lives up to rigorous American Standard requirements.

# Odyssey Split Systems Features and Benefits

## Microchannel Condenser Coil

Microchannel condensing coils are all-aluminum coils with fully-brazed construction. This design reduces risk of leaks and provides increased coil rigidity — making them more rugged on the jobsite. Their flat streamlined tubes with small ports and metallurgical tube-to-fin bond allow for exceptional heat transfer. Microchannel all-aluminum construction provides several additional benefits:

- Light weight (simplifies coil handling)
- Easy to recycle
- Minimize galvanic corrosion

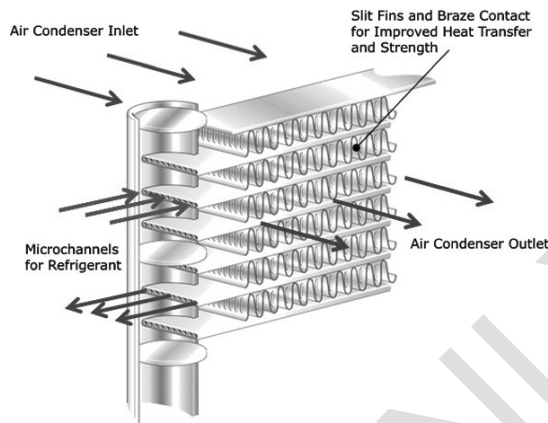

## Standard and Optional Features

Figure 1. Compressors

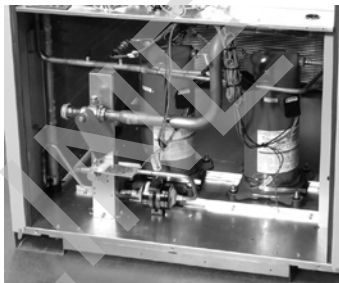
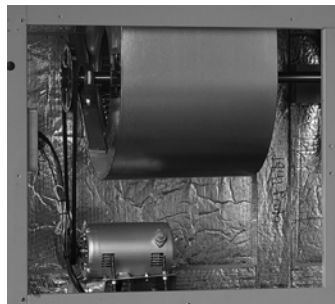

Figure 2. Belt drive motor



**2-Speed VFD** — A variable frequency drive is used to reduce the supply fan motor speed to 66% of its full capacity during part load cooling conditions.

**Airflow Distribution** — Odyssey can replace an older machine with old ductwork and, in many cases, improve the comfort through better air distribution.

**Anti-Short Cycle Timing** — The Symbio™ 700 controller provides a 3 minute minimum "ON" time and 3 minute "OFF" time for compressors to enhance compressor reliability by assuring proper oil return.

**Belt Drive Motors** — For additional static requirements, Odyssey Split Systems offer standard belt drive motors to meet and exceed a wide range of airflow needs.

# Odyssey Split Systems Features and Benefits

**Colored Connectors and Wiring** — Interconnecting wiring between components is standardized using colored and keyed connectors and colored wires, helping to save time and money tracing wires and diagnosing the unit.

**Compressors** — Odyssey Split Systems contain the best compressor technology available to achieve the highest possible performance. Dual compressors perform very well under part load cooling conditions and system back-up applications. Dual compressors are available on 6-25 ton models and allow for efficient cooling utilizing 2-stages of compressor operation.

**Complete Coat™ Microchannel Condenser Coil** — This cathodic, epoxy-type electro-disposition coating is formulated for high edge builds and provides excellent resistance and durability in potentially corrosive environments due to alkalies, acids, alcohols, petroleum, seawater, salty air, etc. Available for Microchannel units only.

**Convertible Units** — The air handlers ship in a horizontal configuration. They can be easily converted to vertical by simply repositioning the drain pan.

**Crankcase Heaters** — These band heaters provide improved compressor reliability by warming the oil to prevent migration during off-cycles or low ambient conditions.

**Dual Sloped Drain Pans** — Every Odyssey unit has a non-corrosive, removable, double sloped drain pan that's easy to clean and reversible to allow installation of drain trap in two positions on either side of the unit.

**Duct flanges** — An optional field installed kit that can save time and money.

**Easy Access Low Voltage Connections** — Thermostat and other low voltage control wiring connections are made directly to the Symbio 700 and other boards in the system. Screw-type pressure connectors are detachable from the boards for easy connection of control wires — saving cost and time.

**Electric Heaters** — Electric heat modules are available in a variety of voltages and capacities.

**Foil Faced Insulation** — All internal air handler surfaces have cleanable foil-faced insulation. All edges are either captured or sealed to ensure insulation fibers do not get into the airstream.

**Hail/Vandal Guards** — These coil guards shall be either factory or field installed for condenser coil protection. This feature protects the condenser coil from vandalism and/or hail damage. When ordered factory installed, it also adds additional shipping protection.

**High Static Motor** — Available on many models, this high static motor accessory extends the capability of the standard unit.

**High and Low Voltage Control Panel** — High voltage components and connections are isolated from low voltage and covered with a sheet metal panel. This allows setup and test parameters at the Symbio™ 700 display and the VFD keypad display to be safely viewed and adjusted in the low voltage section of the control panel.

**High Pressure Control** — All units include High Pressure Control as standard.

**Low Ambient Cooling** — All Odyssey units have cooling capabilities down to 0°F as standard. At temperatures below 50°F, some reduction in cooling capacity can be expected. When the optional Low Ambient Accessory kit is field installed, the full capacity of the unit is available down to 0°F.

**Low Voltage Connections** — Low voltage wiring connects directly to the control boards in the unit via detachable connectors. This makes it easy for the installer to attach the wires and then snap the connectors into place.

**Phase Monitor/Reversal Protection** — Phase monitor shall provide 100% protection for motors and compressors against problems caused by phase loss, phase imbalance, and phase reversal. Phase monitors are equipped with an LED that provides an ON or FAULT indicator.

**Quick-Access Panels** — Remove a few screws for access to the standardized internal components and wiring.

**Single Point Power** — A single electrical connection powers the unit.

**Single Side Service** — Single side service is standard on all units.

**Single Zone Variable Air Volume (SZVAV)** — A variable frequency drive is used in conjunction with the Symbio™ 700 to provide supply fan motor speed modulation. For SZVAV control, the drive will accelerate or decelerate as required to meet the Zone Cooling demand. In order to

## Odyssey Split Systems Features and Benefits

---

maximize energy savings, the VFD will be held at minimum speed until the load in the zone requires the speed to increase. The supply fan speed will be reduced to a minimum of 58%<sup>1</sup> during ventilation and part load cooling demands, and 80% during full load cooling demands with the ability to fully modulate. The commissioning maximum and minimum airflow points can be easily set by programming these parameters at the display on the Symbio control board.

**Standardized Components** — Components are placed in the same location on all Odyssey units. Because of these standardized components throughout the Odyssey line, contractors/owners can stock fewer parts.

**Symbio™ 700** — Standard on Odyssey condensers, the Symbio™ 700 controller provides exceptional machine control with a focus on system reliability and application flexibility. The Symbio controller provides direct access to the Symbio Service and Installation mobile application for easy setup and troubleshooting with no special tools. A wide range of system integration options (Non-communicating, BACnet®, LonTalk®, etc.) provide options to meet the needs of your application.

**Thermal Expansion Valve with Bypass Check Valves** — This feature is standard on all indoor units.

**Unit Cabinet** — The compact cabinet takes up less room and is less costly to ship. The design also ensures water integrity.

<sup>1</sup> 64% for part load and 83% for full load if a max speed of less than 44.5 Hz is desired.

# Odyssey Split Systems Features and Benefits

	Standard Features	Options <sup>(a)</sup>	
		Factory Installed	Field Installed
1-year Limited Parts Warranty	X		
5-year Limited Compressor Warranty	X		
2-Speed Variable Frequency Drive		X	
Belt Drive Motors	X		
Colored Connectors and Wiring	X		
Complete Coat™ Microchannel Condenser Coil		X	
Compressor Discharge Temperature Limit (DTL)	X		
Convertible Airflow	X		
Crankcase Heaters	X		
Easy Access Low Voltage Connections	X		
Electric Heaters			X
Filters	X		
Filters – 2" MERV 13			X
Foil-Faced and Edge Captured Insulation	X		
Hail/Vandal Guards		X	X
High Pressure Control	X		
High Static Motor Kit <sup>(b)</sup>			X
Hot Gas Bypass			X
IAQ Dual Sloped and Removable Drain Pans	X		
Low Ambient Cooling			X
Liquid Line Refrigerant Drier	X		
Low Pressure Control	X		
Low Static Motor Kit <sup>(b)</sup>			X
Low Voltage Circuit Protection	X		
Phase Loss/Reversal Monitor	X		
Quick Access Panels	X		
Scroll Compressors	X		
Single Point Power	X		
Single Side Service	X		
Single Zone Variable Air Volume (SZVAV / 2-Speed Fan)		X	
Standardized Components	X		
Symbio™ Controls	X		
Thermal Expansion Valve	X		
Vibration Isolators			X

<sup>(a)</sup> Refer to model number description for option availability or contact Product Support.

<sup>(b)</sup> Available on constant volume units only. See Accessories chapter for more information.

## Symbio™ 700 Controls

Figure 3. Symbio 700 board

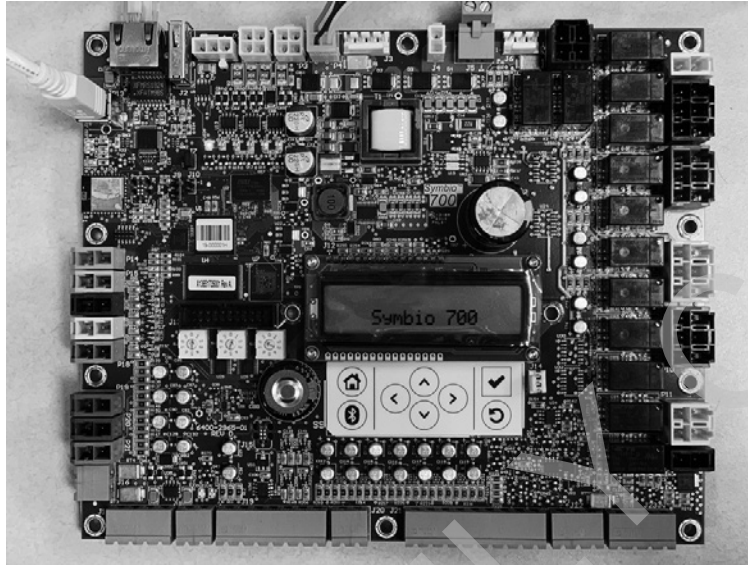

Symbio 700 controls provide unit control for heating, cooling, and ventilating, utilizing input from sensors that measure outdoor and indoor temperature. Symbio also provides outputs for building automation systems and expanded diagnostics. Quality and reliability are enhanced through Symbio control and logic:

- Prevents the unit from short cycling, considerably improving compressor life.
- Ensures the compressor will run for a specific amount of time which allows oil to return for better lubrication, enhancing the reliability of the compressor.
- Reduces the number of components required to operate the unit, reducing possibilities for component failure.

### Installation and Service

The Symbio™ 700 control platform provides a user-friendly, onboard interface that makes setup and continued operation easy – or users can take advantage of the Symbio™ Service and Installation Mobile App for setup, troubleshooting, and operation. Both the Symbio onboard user interface and mobile app simplify troubleshooting by displaying active alarms. Symbio eliminates the need for field-installed, anti-short cycle timer and time delay relays. The wiring of the low voltage connections to the unit and zone sensors is simple, making installation easy.

### Testing

Symbio™ 700 requires no special tools to run the unit through its paces. Simply navigate to the 'Service' section of the user interface or the 'Utilities' section of the Symbio™ Service and Installation Mobile App and enter the test section. Here the unit can be placed in the desired operating condition for a pre-determined amount of time supporting troubleshooting efforts in the field. The Symbio 700 will return to normal control when the user exits test mode or when the pre-determined, user-selected Service Test time has expired.

### Other Benefits

- Symbio™ 700 built-in anti-shortcycle timer, time delay relay and minimum "on" time control functions are factory tested to assure proper operation.
- Symbio 700 softens electrical "spikes" by staging on fans, compressors and heaters.
- Intelligent Fallback is a benefit to the building occupant. If a component goes astray, the unit will continue to operate at predetermined temperature setpoint.



# Odyssey Split Systems Features and Benefits

- Intelligent Anticipation is a standard feature. It functions continuously as Symbio 700 and zone sensor(s) work together in harmony to provide much tighter comfort control than conventional electromechanical thermostats.
- The Symbio 700 design is standardized across the board, ensuring a lower cost to owners.

## Additional Controls

**VariTrac® Building Automation System** – When American Standard's changeover VAV System for light commercial applications is coupled with the unit, it provides the latest in technological advances for comfort management systems and can allow thermostat control in every zone served by VariTrac.

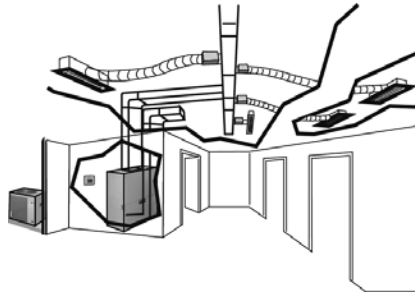

**Froststat™** – This control (a standard feature on all air handlers) utilizes a capillary bulb embedded in the face of the evaporator coil which monitors coil temperature to inhibit evaporator icing and protect the compressor. Useful for applications with low leaving air temperatures, low airflow and/or high latent load applications.

**LonTalk® Communications Interface** – The LonTalk communications interface allows the unit to communicate as a Tracer LON® device or directly with generic LonTalk Network Building Automation System Controls.

**BACnet® Communication Interface (BCI)** – The BACnet Communication Interface allows the unit to communicate directly with a generic open protocol BACnet MS/TP or IP Network Building Automation Control System.

**Zone Sensors/Thermostats** – Available in programmable, automatic and manual styles.

**Table 2. Odyssey control options – standard and optional**

	Standard Features	Options <sup>(a)</sup>	
		Factory Installed	Field Installed
BACnet® Communication Interface (BCI)		X	
Froststat™ - Evaporator Defrost Control (EDC)	X		
LonTalk® Communications Interface (LCI)		X	
Symbio™ 700 Microprocessor Controls	X		
Thermostat			X
Zone Sensor			X

<sup>(a)</sup> Refer to model number description for option availability or contact Product Support.

# Odyssey Split Systems Accessories

## Cooling Condenser

**Table 3. TTA Accessories**

Model	Used With
<b>Coil (Hail/Vandal) Guard</b>	
BAYGARD063*	TTA072, TTA090
BAYGARD064*	TTA120
BAYGARD065*	TTA150
BAYGARD066*	TTA180, TTA240
BAYGARD067*	TTA300
<b>Universal Hot Gas Bypass Kit</b>	
BAYHGBP010*	All models
<b>Rubber Isolators</b>	
BAYISLT004* (blue)	TTA072, TTA090
BAYISLT005* (black)	TTA120
BAYISLT009* (red)	TTA150, TTA180
BAYISLT010* (green)	TTA240, TTA300
<b>Steel Spring Isolators</b>	
BAYISLT023* (red)	TTA072, TTA090, TTA120**A
BAYISLT024* (black)	TTA120**C/D, TTA150, TTA180
BAYISLT025* (yellow)	TTA240, TTA300
<b>Service Valve Kit</b>	
BAYVALV001*	TTA0724*A, TTA0904*A, TTA1204*A/C
BAYVALV003*	TTA0724*D, TTA0904*D, TTA1204*D
BAYVALV004*	TTA1504*D
BAYVALV005*	TTA1804*D, TTA2404*D
BAYVALV007*	TTA1804*C, TTA2404*C
BAYVALV008*	TTA3004*C
<b>Low Ambient – On/Off Fan Control<sup>(a) (b)</sup></b>	
BAYLOAMS10* (External Mount, small cabinets) <sup>(c)</sup>	(all voltages) TTA072, TTA090, TTA120, TTA150
BAYLOAMS20* (Internal mount, large cabinets)	(all voltages) TTA180, TTA240, TTA300
<b>Transducer Kit for Head Pressure Control (BAYLOAMS10*)</b>	
BAYLOTR001* <sup>(d)</sup>	TTA072**D, TTA090**D, TTA120**D, TTA150**D
<b>LonTalk Communications Interface<sup>(e)</sup></b>	
BAYLTCI005*	All Models
<b>Expansion Module Kit</b>	
BAYMODU002* (XM30)	All Models
BAYMODU004* (XM32)	All Models

(a) Cycles fan on/off (no modulating).

(b) When BAYLOAM is used, the Evaporator Defrost Control (EDC) must be disabled in the Symbio 700 controller configuration.

(c) Kit mounts external to the outdoor unit and operates by sensing ambient temperature and discharge pressure.

(d) BAYLOTR001\* required when BAYLOAMS10\* kits are used with units that have 2 compressors (dual circuit) and 1 condenser fan.

(e) Field installed LonTalk interface requires installation of Symbio control board with Advanced Diagnostics (not included).

# Odyssey Split Systems Accessories

## Air Handler

**Table 4. TWE Accessories**

Model	Used With
<b>Base (Subbase)</b>	
BAYBASE009*	TWE060
BAYBASE0010*	TWE072, TWE090
BAYBASE0011*	TWE120
BAYBASE0012*	TWE150, TWE180
BAYBASE0013*	TWE240, TWE300
<b>Drip Kit</b>	
BAYDRKT006*	TWE060
BAYDRKT007*	TWE072, TWE090
BAYDRKT008*	TWE120
BAYDRKT009*	TWE150, TWE180
BAYDRKT010*	TWE240, TWE300
<b>Duct Flange Kit</b>	
BAYDUCT010*	TWE051, TWE060, TWE072, TWE076, TWE090, TWE101, TWE120
BAYDUCT020*	TWE126, TWE150, TWE156, TWE180, TWE201, TWE240, TWE251, TWE300
<b>Filters – 2" MERV 13</b>	
BAYFILT001*	TWE060
BAYFILT002*	TWE072, TWE090
BAYFILT003*	TWE120
BAYFILT004*	TWE150, TWE180
BAYFILT005*	TWE240, TWE300
<b>High Static Motor Kits<sup>(a)</sup></b>	
BAYHSMT104* — 1.5HP (230/1) with Motor Sheave, Fan Sheave and Belt	TWE060*1A/B
BAYHSMT105* — 1.5HP (230-460/3) with Motor Sheave, Fan Sheave and Belt	TWE060*3A/B, TWE060*4A/B
BAYHSMT106* — 1.5HP (575/3) with Motor Sheave, Fan Sheave and Belt	TWE060*WA
BAYHSMT107* — 2 HP (230/1) with Motor Sheave, Fan Sheave and Belt	TWE090*1A/B
BAYHSMT108* — 2HP (230-460/3) with Motor Sheave, Fan Sheave and Belt	TWE072*3B, TWE090*3A/B
BAYHSMT109* — 2 HP (575/3) with Motor Sheave, Fan Sheave and Belt	TWE072*WB, TWE090*WA/B
BAYHSMT110* — 3HP (230/460/3) with Motor Sheave, Fan Sheave and Belt	TWE072*3B, TWE090*3A/B
BAYHSMT111* — 3 HP (575/3) with Motor Sheave, Fan Sheave and Belt	TWE072*WB, TWE090*WA/B
BAYHSMT112* — 3HP (230/460/3) with Motor Sheave, Fan Sheave and Belt	TWE120*3A/B
BAYHSMT113* — 3 HP (575/3) with Motor Sheave, Fan Sheave and Belt	TWE120*WA/B
BAYHSMT114* — 3HP (230/460/3) with Motor Sheave, Fan Sheave and Belt	TWE150*3B
BAYHSMT115* — 3 HP (575/3) with Motor Sheave, Fan Sheave and Belt	TWE150*WB
BAYHSMT116* — 5 HP (230/3) with Motor Sheave, Fan Sheave and Belt	TWE150*3B
BAYHSMT117* — 5HP (460/3) with Motor Sheave, Fan Sheave and Belt	TWE150*3B
BAYHSMT118* — 5 HP (575/3) with Motor Sheave, Fan Sheave and Belt	TWE150*WB
BAYHSMT119* — 5 HP (208-230/3) with Motor Sheave and Fan Sheave (Stock Belt used)	TWE180*3B
BAYHSMT120* — 5HP (460/380-415/3) with Motor Sheave and Fan Sheave (Stock Belt used)	TWE180*3B
BAYHSMT121* — 5 HP (575/3) with Motor Sheave and Fan Sheave (Stock Belt used)	TWE180*WB
BAYHSMT124* — 7.5 HP (230/3) with Motor Sheave, Fan Sheave and Belt	TWE240*3B
BAYHSMT126* — 7.5 HP (460/3) with Motor Sheave, Fan Sheave and Belt	TWE240*4B
BAYHSMT123* — 7.5 HP (575/3) with Motor Sheave, Fan Sheave and Belt	TWE240*WB

# Odyssey Split Systems Accessories

**Table 4. TWE Accessories (continued)**

Model	Used With
<b>Rubber Isolators<sup>(b) (c) (d)</sup></b>	
BAYISLT004* (Floor — Blue)	TWE060, TWE072, TWE090, TWE120
BAYISLT009* (Floor — Red) <sup>(e)</sup>	TWE150, TWE180
BAYISLT010* (Floor — Green) <sup>(e)(b)</sup>	TWE240, TWE300
BAYISLT012* (Suspended — Red/Green)	TWE150, TWE180
BAYISLT013* (Suspended — Red/Green) <sup>(d)</sup>	TWE060
BAYISLT014* (Suspended — Green) <sup>(d)</sup>	TWE072, TWE090
BAYISLT015* (Suspended — Green/Black) <sup>(d)</sup>	TWE120
BAYISLT016* (Suspended — Red/Green)	TWE240, TWE300
<b>Steel Spring Isolators<sup>(c)</sup></b>	
BAYISLT019* (Floor — Red) <sup>(e)(b)</sup>	TWE060, TWE072, TWE090, TWE120
BAYISLT021* (Floor — Black) <sup>(e)(b)</sup>	TWE150, TWE180
BAYISLT032* (Floor — Black/Yellow) <sup>(e)(b)</sup>	TWE240, TWE300
BAYISLT028* (Suspended — Tan)	TWE060
BAYISLT029* (Suspended — Red)	TWE072, TWE090, TWE120
BAYISLT030* (Suspended — Black)	TWE150, TWE180
BAYISLT031* (Suspended — Black/Yellow)	TWE240, TWE300
<b>Low Static Drive Kit<sup>(a)</sup></b>	
BAYLSMT001*	TWE240*3, TWE240*4
<b>Plenum<sup>(f)</sup></b>	
BAYPLNM015* (Discharge Plenum & Grille) <sup>(f)</sup>	TWE060
BAYPLNM016* (Discharge Plenum & Grille) <sup>(f)</sup>	TWE072, TWE090
BAYPLNM017* (Discharge Plenum & Grille) <sup>(f)</sup>	TWE120
BAYPLNM018* (Discharge Plenum/Hydronic Coil Plenum & Grille) <sup>(f)</sup>	TWE150, TWE180
BAYPLNM019* (Discharge Plenum/Hydronic Coil Plenum & Grille) <sup>(f)</sup>	TWE240, TWE300
BAYPLNM020* (Hydronic Coil Discharge Plenum & Grille) <sup>(f)</sup>	TWE060
BAYPLNM021* (Hydronic Coil Discharge Plenum & Grille) <sup>(f)</sup>	TWE072, TWE090
BAYPLNM022* (Hydronic Coil Discharge Plenum & Grille) <sup>(f)</sup>	TWE120
BAYPLNM030* (Electric Heat Discharge Plenum & Grille) <sup>(f)</sup>	TWE060
BAYPLNM031* (Electric Heat Discharge Plenum & Grille) <sup>(f)</sup>	TWE072, TWE090
BAYPLNM032* (Electric Heat Discharge Plenum & Grille) <sup>(f)</sup>	TWE120
BAYPLNM033* (Electric Heat Discharge Plenum & Grille) <sup>(f)</sup>	TWE150, TWE180
BAYPLNM034* (Electric Heat Discharge Plenum & Grille) <sup>(f)</sup>	TWE240, TWE300
<b>Return Air Grille</b>	
BAYGRLE001*	TWE060
BAYGRLE002*	TWE072, TWE090
BAYGRLE003*	TWE120
BAYGRLE004*	TWE150, TWE180
BAYGRLE005*	TWE240, TWE300
<b>Symbio™ Options Module Kit</b>	
BAYMODU001*	All TWE units with Digit 15 = 1 and Electric heater installed
<b>Transformer</b>	
BAYTFMR014* - 100 VA Transformer (208-230V)	All TWE072 - TWE300, 208-230V units
BAYTFMR015* - 100 VA Transformer (460V)	All TWE072 - TWE120, 460V units
BAYTFMR016* - 100 VA Transformer (575V)	All TWE072 - TWE120, 460V units
BAYTFMR017* - 100 VA Transformer (400 V)	All TWE072 - TWE120 380V/60 Hz unit
<b>Water Kits</b>	
BAYWATR022* (Steam Coil Enclosure) <sup>(f)</sup>	TWE060
BAYWATR023* (Steam Coil Enclosure) <sup>(f)</sup>	TWE072, TWE090

# Odyssey Split Systems Accessories

**Table 4. TWE Accessories (continued)**

Model	Used With
BAYWATR024* (Steam Coil Enclosure) <sup>(f)</sup>	TWE120
BAYWATR025* (Steam Coil Enclosure) <sup>(f)</sup>	TWE150, TWE180
BAYWATR026* (Steam Coil Enclosure) <sup>(f)</sup>	TWE240, TWE300
BAYWATR027* (Hot Water Coil Enclosure) <sup>(f)</sup>	TWE060
BAYWATR028* (Hot Water Coil Enclosure) <sup>(f)</sup>	TWE072, TWE090
BAYWATR029* (Hot Water Coil Enclosure) <sup>(f)</sup>	TWE120
BAYWATR030* (Hot Water Coil Enclosure) <sup>(f)</sup>	TWE150, TWE180
BAYWATR031* (Hot Water Coil Enclosure) <sup>(f)</sup>	TWE240, TWE300
<b>Wire Kit — 180° Blower Discharge Reversal Kit<sup>(g)</sup></b>	
BAYWRKT002*	TWE060, TWE072, TWE090, TWE120

- (a) Used on constant volume air handlers only.
- (b) Requires use of subbase accessory.
- (c) In units with steam or hot water coils applied vertically or horizontally, check IOM for proper Isolator Kit selection.
- (d) Do not use if blower will operate less than 600 RPM.
- (e) When the air handler is in the vertical position and close proximity trapping of condensate is required, use of subbase is required.
- (f) When installed horizontally, plenum/water coil must be self-supported. When adding vibration isolators, see Isolator Installation Guide (ACC-SVN92\*-EN) for isolator and location matrix.
- (g) Cannot be used on TWE150-300, due to motor mount location.

## Electric Heaters

**Table 5. Electric heaters**

Model	Used With
<b>6–10 Ton Electric Heater Selection</b>	
BAYHTRN106* — 4.33/5.76 kW Heater 208/240/1 Phase	TWE060*1, TWE090*1, TWE120*1
BAYHTRR112* — 8.65/11.52 kW Heater 208/240/1 Phase	TWE060*1, TWE090*1, TWE120*1
BAYHTRS117* — 12.98/17.28 kW Heater 208/240/1 Phase	TWE060*1, TWE090*1, TWE120*1
BAYHTRR123* — 17.31/23.04 kW Heater 208/240/1 Phase	TWE060*1, TWE090*1, TWE120*1
BAYHTRN129* — 21.63/28.80 kW Heater 208/240/1 Phase	TWE090*1, TWE120*1
BAYHTRN305* — 3.76/5.00 kW Heater 208/240/3 Phase	TWE060*3, TWE072*3B, TWE090*3, TWE120*3 (CV, VFD, & OS MTR)
BAYHTRR310* — 7.48/9.96 kW Heater 208/240/3 Phase	TWE060*3, TWE072*3B, TWE090*3, TWE120*3 (CV, VFD, & OS MTR)
BAYHTRR315* — 11.24/14.96 kW Heater 208/240/3 Phase	TWE060*3, TWE072*3B, TWE090*3, TWE120*3 (CV, VFD, & OS MTR)
BAYHTRN325* — 18.72/24.92 kW Heater 208/240/3 Phase	TWE060*3, TWE072*3B, TWE090*3, TWE120*3 (CV, VFD, & OS MTR)
BAYHTRN335* — 26.20/34.88 kW Heater 208/240/3 Phase	TWE090*3, TWE120*3 (CV, VFD, & OS MTR)
BAYHTRN405* — 5.00 kW Heater 460/3 Phase <sup>(a)</sup>	TWE060*4, TWE072*3*****0, TWE072*4*****A/B, TWE090*3*****0, TWE090*4B*****A/B, TWE120*3*****0, TWE120*4*****A/B
BAYHTRR410* — 9.96 kW Heater 460/3 Phase <sup>(a)</sup>	TWE060*4, TWE072*3*****0, TWE072*4*****A/B, TWE090*3*****0, TWE090*4B*****A/B, TWE120*3*****0, TWE120*4*****A/B
BAYHTRR415* — 14.96 kW Heater 460/3 Phase <sup>(a)</sup>	TWE060*4, TWE072*3*****0, TWE072*4*****A/B, TWE090*3*****0, TWE090*4B*****A/B, TWE120*3*****0, TWE120*4*****A/B
BAYHTRN425* — 24.92 kW Heater 460/3 Phase <sup>(a)</sup>	TWE060*4, TWE072*3*****0, TWE072*4*****A/B, TWE090*3*****0, TWE090*4B*****A/B, TWE120*3*****0, TWE120*4*****A/B
BAYHTRN435* — 34.88 kW Heater 460/3 Phase <sup>(a)</sup>	TWE090*3*****0, TWE090*4B*****A/B, TWE120*3*****0, TWE120*4*****A/B
BAYHTRNW05* — 5 kW Heater 575/3 Phase	TWE060*W, TWE072*W, TWE090*W, TWE120*W (CV, VFD, & OS MTR)
BAYHTRRW10* — 9.96 kW Heater 575/3 Phase	TWE060*W, TWE072*W, TWE090*W, TWE120*W (CV, VFD, & OS MTR)
BAYHTRRW15* — 14.96 kW Heater 575/3 Phase	TWE060*W, TWE072*W, TWE090*W, TWE120*W (CV, VFD, & OS MTR)
BAYHTRNW25* — 24.92 kW Heater 575/3 Phase	TWE060*W, TWE072*W, TWE090*W, TWE120*W (CV, VFD, & OS MTR)
BAYHTRNW35* — 34.88 kW Heater 575/3 Phase	TWE090*W, TWE120*W (CV, VFD, & OS MTR)
<b>12.5–25 Ton Electric Heater Selection</b>	
BAYHTRP310* — 7.51/10.0 kW Heater 208/230 3 Phase	TWE150*3, TWE180*3, TWE240*3, TWE300*3 (CV, VFD, & OS MTR)

# Odyssey Split Systems Accessories

**Table 5. Electric heaters (continued)**

Model	Used With
BAYHTRP320* — 14.96/19.92 kW Heater 208/230 3 Phase	TWE150*3, TWE180*3, TWE240*3 , TWE300*3 (CV, VFD, & OS MTR)
BAYHTRP330* — 22.47/29.92 kW Heater 208/230 3 Phase	TWE150*3, TWE180*3, TWE240*3 , TWE300*3 (CV, VFD, & OS MTR)
BAYHTRP350* — 37.44/49.84 kW Heater 208/230 3 Phase	TWE150*3, TWE180*3, TWE240*3 , TWE300*3 (CV, VFD, & OS MTR)
BAYHTRP410* — 10.0 kW Heater 460/3 Phase <sup>(a)</sup>	TWE150*3*****0, TWE150*4*****A/B, TWE180*3*****0, TWE180*4*****A/B, TWE240*4 (CV, VFD, & OS MTR), TWE300*4 (CV & VFD)
BAYHTRP420* — 19.92 kW Heater 460/3 Phase <sup>(a)</sup>	TWE150*3*****0, TWE150*4*****A/B, TWE180*3*****0, TWE180*4*****A/B, TWE240*4 (CV, VFD, & OS MTR), TWE300*4 (CV & VFD)
BAYHTRP430* — 29.92 kW Heater 460/3 Phase <sup>(a)</sup>	TWE150*3*****0, TWE150*4*****A/B, TWE180*3*****0, TWE180*4*****A/B, TWE240*4 (CV, VFD, & OS MTR), TWE300*4 (CV & VFD)
BAYHTRP450* — 49.84 kW Heater 460/3 Phase <sup>(a)</sup>	TWE150*3*****0, TWE150*4*****A/B, TWE180*3*****0, TWE180*4*****A/B, TWE240*4 (CV, VFD, & OS MTR), TWE300*4 (CV & VFD)
BAYHTRPW10* — 10.0 kW Heater 575/3 Phase	TWE150*W, TWE180*W, TWE240*W , TWE300*W(CV, VFD, & OS MTR)
BAYHTRPW20* — 19.92 kW Heater 575/3 Phase	TWE150*W, TWE180*W, TWE240*W , TWE300*W(CV, VFD, & OS MTR)
BAYHTRPW30* — 29.92 kW Heater 575/3 Phase	TWE150*W, TWE180*W, TWE240*W , TWE300*W(CV, VFD, & OS MTR)
BAYHTRPW50* — 49.84 kW Heater 575/3 Phase	TWE150*W, TWE180*W, TWE240*W , TWE300*W(CV, VFD, & OS MTR)

**Note:** Electric Heaters not available for 380/60hz

<sup>(a)</sup> BAYHTR\*4 & BAYHTRP4\* heaters are available for 230V units that have been field-converted to 460V.

ONLINE ONLY

# Odyssey Split Systems Application Considerations

Application of this product should be within the cataloged airflow and performance considerations.

## Clearance Requirements

The recommended clearances identified with unit dimensions should be maintained to assure adequate serviceability, maximum capacity and peak operating efficiency. Actual clearances which appear inadequate should be reviewed with the local representative.

## 180° Blower Rotation

The 5, 6, 7.5, and 10 ton standard air handler blower section can be rotated 180° to change the discharge pattern. This modification must be done in the field and requires an additional kit. See unit installation guide.

## Low Ambient Cooling

As manufactured, all Odyssey units have cooling capabilities down to 0°F. At temperatures below 50°F, some reduction in cooling capacity can be expected. When the optional Low Ambient Accessory kit is field installed, the full capacity of the unit is available down to 0°F. When using these units with control systems such as bypass changeover Variable Air Volume, make sure to consider the requirement for a head pressure control to allow low ambient cooling.

**Figure 4. Typical split system application**

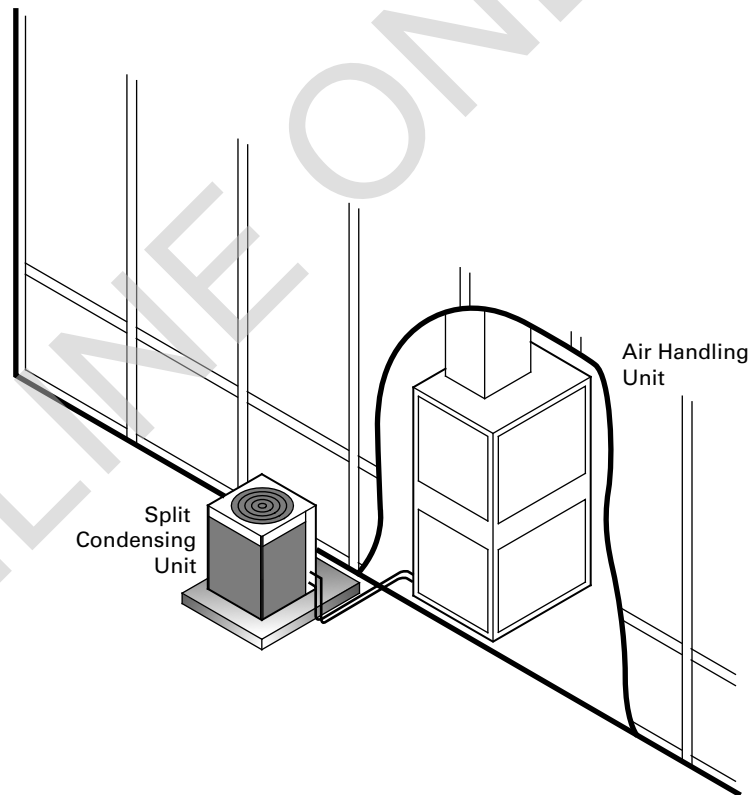

# Odyssey Split Systems Application Considerations

**Figure 5. Typical horizontal air handler application**

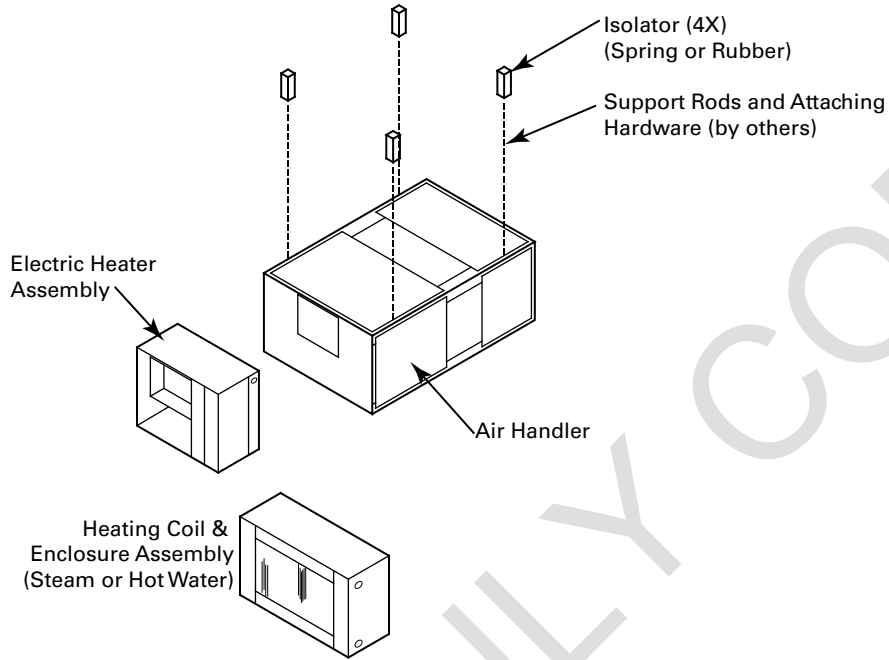

**Figure 6. Typical vertical air handler application**

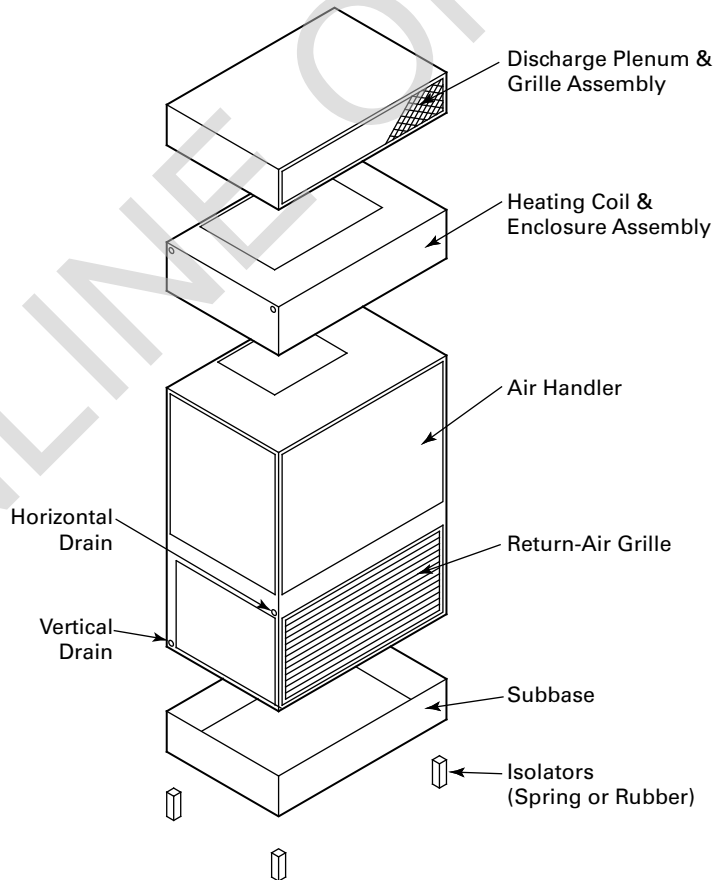



# Odyssey Split Cooling Selection Procedure

## Cooling Capacity

1. Calculate the building's total and sensible cooling loads at design conditions, using standardized calculation methods.
2. Size the equipment using the gross cooling capacity tables. Match the cooling loads at design conditions. For example, if the following specifies the building cooling requirements:  
 Electrical Characteristics: 460/60/3  
 Summer Design Conditions: Entering Evap Coil—80°F DB/67°F WB , Outdoor Ambient—95°F  
 Total Cooling Load: 86 MBh  
 Sensible Cooling Load: 60 MBh  
 Airflow: 3000 cfm  
 External Static Pressure: 0.77 inches of water gauge
3. Use Table 15, p. 32 to determine that TTA09043A with TWE09043A has a gross cooling capacity of 97.7 MBh and 74.6 MBh sensible capacity at 95°F DB ambient and 3000 cfm with 80°F DB/67° F WB air entering the evaporator.
4. To find the net cooling capacities, fan motor heat must be subtracted. Determine the total unit static pressure:  
 External Static Duct System: 0.77  
 Standard Filter: 0.10 in.  
 Supplementary Electric Heat: 0.23 in.  
 Total Static Pressure: 1.10 in.

### Notes:

- *The Evaporator Fan Performance Table has included the effect of a 1 in. filter already. Therefore, the actual Total Static Pressure is 1.10 - 0.10 = 1.00 in. . With 3000 cfm and 1.00 in., Table 50, p. 67 shows 1.97 Bhp (high static drive kit required).*
- *This formula can be used to calculate Fan Motor Heat:*  
 $3.15 \times \text{Bhp} = \text{MBh}$   
 $3.15 \times 1.97 = 6.2 \text{ MBh}$   
 $\text{Net Total Cooling Capacity} = 97.7 \text{ MBh} - 6.2 \text{ MBh} = 91.5 \text{ MBh}$   
 $\text{Net Sensible Cooling Capacity} = 74.6 \text{ MBh} - 6.2 \text{ MBh} = 68.4 \text{ MBh}$

## Heating Capacity

5. Calculate the building heating load using the American Standard calculation form or any other standard accepted method.
6. Size the equipment using Table 68, p. 84 to match the heating loads at design conditions. For example, if the following specifies the building heating requirements:  
 Total Heating Load: 97.0 MBh  
 Airflow: 2625 cfm  
 Supplementary Electric Heaters
7. Use Table 69, p. 85 to determine that the 34.88 kW heater has a capacity of 119,045 Btuh.
8. From the Electrical Characteristics table, p. 98, the 34.88 kW heater at 460V indicates the heater model is BAYHTRN435A.

# Odyssey Split Cooling Selection Procedure

---

## Air Delivery

1. The external static pressure drop through the air distribution system is 0.77 inches of water gauge, use Table 68, p. 84 to determine that the static pressure drop through the electric heater is 0.23 inches of water ( $0.77 + 0.23 = 1.00$  in.).
2. Enter Table 50, p. 67 for TWE09043A at 2625 cfm and 1.00 static pressure. The high static motor at 995 RPM gives the desired airflow.

ONLINE ONLY COPY

# Odyssey Split Cooling Model Number Description

## Cooling Condenser

### Digit 1, 2, 3— Unit Function

**TTA** = Split System Cooling

### Digit 4, 5, 6 — Tonnage

**072** = 6 Tons (60 Hz)  
**090** = 7.5 Tons (60 Hz)  
**120** = 10 Tons (60 Hz)  
**150** = 12.5 Tons (60 Hz)  
**180** = 15 Tons (60 Hz)  
**240** = 20 Tons (60 Hz)  
**300** = 25 Tons (60Hz)

### Digit 7 — Refrigerant

**4** = R-410A

### Digit 8 — Voltage

**3** = 208-230 Vac - 3 PH (60Hz)  
**4** = 460 Vac - 3 PH (60Hz)  
**W** = 575 Vac - 3 PH (60Hz)  
**K** = 380 Vac - 3 PH (60Hz)

### Digit 9 — Refrigeration Circuit/Stage

**A** = 1 Compressor/1 Line/1 Stage (Single)  
**C** = 2 Compressors/1 Line/2 Stage (Manifold)  
**D** = 2 Compressors/2 Line/2 Stage (Dual)

### Digit 10 — Major Design Sequence

**A** = Rev A

### Digit 11 — Minor Design Sequence

**A** = Rev A

### Digit 12, 13 — Service Digits

\*\*

### Digit 14 — Efficiency Generation

**A** = Generation A

### Digit 15 — Controls

**S** = Symbio™

### Digit 16 — None

**0** = None

### Digit 17 — Coil Protection

**0** = Standard Coil  
**1** = Standard Coil w/ Hail Guard  
**4** = Complete Coat Condenser Coil (MCHE)  
**5** = Complete Coat Condenser Coil with Hail Guard (MCHE)

### Digit 18, 19, 20 — None

**0** = None

### Digit 21 — Communications Options

**0** = No Option  
**1** = Advanced Diagnostics and BACnet® BAS  
**2** = Advanced Diagnostics and LonTalk® Communications Interface (LCI)

### Digit 22 to 40 — None

**0** = None

# Odyssey Split Cooling Model Number Description

## Air Handler

### Digit 1, 2, 3 — Unit Function

**TWE** = Air Handler

### Digit 4, 5, 6— Tonnage

**060** = 5 Tons (60 Hz)  
**072** = 6 Tons (60Hz)  
**090** = 7.5 Tons (60 Hz)  
**120** = 10 Tons (60 Hz)  
**150** = 12.5 Tons (60 Hz)  
**180** = 15 Tons (60 Hz)  
**240** = 20 Tons (60 Hz)  
**300** = 25 Tons (60 Hz)

### Digit 7 — Refrigerant

**4** = R-410A

### Digit 8 — Voltage

**1** = 208-230 Vac - 1 PH (60 Hz)  
**3** = 208-230 Vac - 3 PH (60 Hz)  
**4** = 460 Vac - 3 PH (60 Hz)  
**W** = 575 Vac - 3 PH (60 Hz)  
**K** = 380 Vac - 3 PH (60Hz)

### Digit 9 — Refrigeration Circuit/Stage

**A** = Single Circuit  
**B** = Dual Circuit

### Digit 10 — Major Design Sequence

**A** = Rev A

### Digit 11 — Minor Design Sequence

**A** = Rev A

### Digit 12, 13 — Service Digits

\*\*

### Digit 14 — Efficiency Generation

**A** = Generation A (2018 DOE)

### Digit 15 — Controls

**1** = Constant Volume  
**C** = 2 Stage Airflow (Electromechanical Cond Only)  
**D** = 2 Stage Airflow/Single Zone VAV (Symbio Cond Only)

### Digit 16 — Indoor Fan Sizes

**0** = Standard Motor  
**4** = High Static – (Oversized Motor for VFD Units)

### Digit 17 to 40 — None

**0** = None

# Odyssey Split Cooling General Data

**Table 6. General data — 6-7.5 tons (TTA0724\*A\*-TTA0904\*D\*) condensing units — 60 Hz**

	<b>6 Tons Single Compressor TTA0724*A*</b>	<b>6 Tons Dual Compressor TTA0724*D*</b>	<b>7.5 Tons Single Compressor TTA0904*A*</b>	<b>7.5 Tons Dual Compressor TTA0904*D*</b>
<b>Cooling Performance - Gross Cooling Capacity</b>				
Matched Air Handler	TWE0904*A*	TWE0724*B*	TWE0904*A*	TWE0904*B*
AHRI Rated Airflow	2,400	2,400	3,000	2,625
Gross Cooling Capacity - System	78,000	76,000	98,000	92,000
Condensing Unit Only	69,000	68,000	91,000	88,000
AHRI Net Cooling Capacity	76,000	75,000	95,000	91,000
<b>Efficiency</b>				
Matched Air Handler (EER)	11.5	11.4	11.5	11.4
Condensing Unit Only (EER)	13.6	12.0	12.7	12.8
System (IEER)	13.1	12.9	13.1	12.9
System kW/Condensing Unit kW	5.7 / 5.1	5.9 / 5.6	7.8 / 7.1	7.4 / 6.9
<b>Compressor</b>				
Type	Scroll	Scroll	Scroll	Scroll
No./Tons	1 / 5.1	2 / 2.4	1 / 6.8	2 / 3.3
<b>System Data</b>				
No. Refrigerant Circuits <sup>(a)</sup>	1	2	1	2
Suction Line Connection (in.) OD <sup>(a)</sup>	1 1/8	7/8	1 3/8	1 1/8
Liquid Line Connection (in.) OD <sup>(a)</sup>	1/2	1/2	1/2	1/2
<b>Outdoor Coil</b>				
Type	MCHE	MCHE	MCHE	MCHE
Tube Size OD/Coil Width MCHE (in.)	0.8	0.8	0.8	0.8
Face Area (sq ft)	18.5	17.4	18.5	17.4
Rows/FPI (Fins per inch)	1/23	1/23	1/23	1/23
<b>Outdoor Fan</b>				
Type	Propeller	Propeller	Propeller	Propeller
No. Used/Diameter (in.)	1/26	1/26	1/26	1/26
Drive Type/No. Speeds	Direct/1	Direct/1	Direct/1	Direct/1
CFM	5,100	5,100	5,100	5,100
No. Motor/HP	1/0.5	1/0.5	1/0.5	1/0.5
Motor RPM	1,100	1,100	1,100	1,100
<b>Refrigerant Charge (Field Supplied)</b>				
lbs of R-410A	10.0	7.0 / 7.0	11.3	7.3 / 7.3
<b>Shipping Dimensions</b>				
HxWxD (in.)	45" x 45" x 38"	45" x 45" x 38"	45" x 45" x 38"	45" x 45" x 38"

**Notes:**

- 6 - 10 ton and 20 -25 ton condensing units are tested in accordance with AHRI Standard 365.
- 12.5 and 15 ton condensing units are AHRI Certified to AHRI Standard 365.
- 6 - 20 ton units are AHRI Certified to AHRI Standard 340-360 (I-P)-2007. Rating conditions are 95°F outdoor air temperature, 80°F entering dry bulb, 67°F entering wet bulb with 25ft of interconnecting refrigerant piping with minimum external static pressure as determined by rating standard.
- 25 ton units are tested in accordance with AHRI Standard 340-360.

<sup>(a)</sup> Refer to refrigerant piping applications manual for line sizing and line length.

# Odyssey Split Cooling General Data

**Table 7. General data — 10-12.5 tons (TTA1204\*D\*-TTA1504\*D\*) condensing units — 60 Hz**

	10 Tons	10 Tons	12.5 Tons
	Dual Compressor TTA1204*D*	Manifolded Compressor TTA1204*C*	Dual Compressor TTA1504*D*
<b>Cooling Performance - Gross Cooling Capacity</b>			
Matched Air Handler	TWE1204*B*	TWE1204*B*	TWE1504*B*
AHRI Rated Airflow	4,000	4,000	4,625
Gross Cooling Capacity - System	119,000	126,000	156,000
Condensing Unit Only	110,000	116,000	156,000
AHRI Net Cooling Capacity	116,000	122,000	154,000
<b>Efficiency</b>			
Matched Air Handler (EER)	11.4	11.3	11.0
Condensing Unit Only (EER)	12.7	12.5	11.3
System (IEER)	12.9	13.3	12.4
System kW/Condensing Unit kW	9.9 / 9.2	10.3 / 9.3	14.2 / 13.9
<b>Compressor</b>			
Type	Scroll	Manifolded Scrolls	Scroll
No./Tons	2 / 4.3	2 / 4.3	2 / 6.1
<b>System Data</b>			
No. Refrigerant Circuits <sup>(a)</sup>	2	1	2
Suction Line Connection (in.) OD <sup>(a)</sup>	1 1/8	1 3/8	1 1/8
Liquid Line Connection (in.) OD <sup>(a)</sup>	1/2	1/2	1/2
<b>Outdoor Coil</b>			
Type	MCHE	MCHE	MCHE
Tube Size OD/Coil Width MCHE (in.)	0.8	0.8	1.0
Face Area (sq ft)	22.7	23.8	27.0
Rows/FPI (Fins per inch)	1/23	1/23	1/23
<b>Outdoor Fan</b>			
Type	Propeller	Propeller	Propeller
No. Used/Diameter (in.)	1/28	1/28	1/28
Drive Type/No. Speeds	Direct/1	Direct/1	Direct/1
CFM	7,800	7,800	7,800
No. Motor/HP	1/1	1/1	1/1
Motor RPM	1,125	1,125	1,125
<b>Refrigerant Charge (Field Supplied)</b>			
lbs of R-410A	8.2 / 8.4	13.1	10.1/9.8
<b>Shipping Dimensions</b>			
HxWxD (in.)	45" x 55" x 42"	45" x 55" x 42"	52.1" x 55" x 42"

**Notes:**

1. 6 - 10 ton and 20 -25 ton condensing units are tested in accordance with AHRI Standard 365.
2. 12.5 and 15 ton condensing units are AHRI Certified to AHRI Standard 365.
3. 6 - 20 ton units are AHRI Certified to AHRI Standard 340-360 (I-P)-2007. Rating conditions are 95°F outdoor air temperature, 80°F entering dry bulb, 67°F entering wet bulb with 25ft of interconnecting refrigerant piping with minimum external static pressure as determined by rating standard.
4. 25 ton units are tested in accordance with AHRI Standard 340-360.

<sup>(a)</sup> Refer to refrigerant piping applications manual for line sizing and line length.

# Odyssey Split Cooling General Data

**Table 8. General data — 15-25 tons (TTA1804\*D\*-TTA3004\*C\*) condensing units — 60 Hz**

	15 Tons Dual Compressor TTA1804*D*	15 Tons Manifolded Compressor TTA1804*C*	20 Tons Dual Compressor TTA2404*D*	20 Tons Manifolded Compressor TTA2404*C*	25 Ton Manifolded Compressor TTA3004*C*
<b>Cooling Performance - Gross Cooling Capacity</b>					
Matched Air Handler	TWE1804*B*	TWE1804*B*	TWE2404*B*	TWE2404*B*	TWE3004*B*
AHRI Rated Airflow	5,550	6,000	8,000	8,000	8,750
Gross Cooling Capacity - System	192,000	192,000	248,000	258,000	306,000
Condensing Unit Only	184,000	184,000	250,000	272,000	318,000
AHRI Net Cooling Capacity	186,000	186,000	244,000	250,000	296,000
<b>Efficiency</b>					
Matched Air Handler (EER)	11.2	11.1	10.2	10.1	10.1
Condensing Unit Only (EER)	13.0	13.1	12.5	12.1	11.7
System (IEER)	12.4	12.8	11.6	12.0	12.0
System kW/Condensing Unit kW	15.4 / 14.1	15.4 / 14.1	21.8 / 20	24.1 / 22.6	29.3 / 27.2
<b>Compressor</b>					
Type	Scroll	Manifolded Scrolls	Scroll	Manifolded Scroll	Manifolded Scrolls
No./Tons	2 / 6.8	2 / 6.8	1/8.7, 1/10.2	2 / 10.0	2 / 12.0
<b>System Data</b>					
No. Refrigerant Circuits <sup>(a)</sup>	2	1	2	1	1
Suction Line Connection (in.) OD <sup>(a)</sup>	1 3/8	1 5/8	1 3/8	1 5/8	2 1/8
Liquid Line Connection (in.) OD <sup>(a)</sup>	1/2	5/8	1/2	5/8	5/8
<b>Outdoor Coil</b>					
Type	MCHE	MCHE	MCHE	MCHE	MCHE
Tube Size OD/Coil Width MCHE (in.)	0.8	0.8	0.8	0.8	1.0
Face Area (sq ft)	44.3	44.3	44.3	44.3	51.3
Rows/FPI (Fins per inch)	1/23	1/23	1/23	1/23	1/23
<b>Outdoor Fan</b>					
Type	Propeller	Propeller	Propeller	Propeller	Propeller
No. Used/Diameter (in.)	2/28	2/28	2/28	2/28	2/28
Drive Type/No. Speeds	Direct/1	Direct/1	Direct/1	Direct/1	Direct/1
CFM	15,500	15,500	15,500	15,500	15,500
No. Motor/HP	2/1	2/1	2/1	2/1	2/1
Motor RPM	1,125	1,125	1,125	1,125	1,125
<b>Refrigerant Charge (Field Supplied)</b>					
lbs of R-410A	11.2/11.3	22.0	11.2 / 11.2	23.8	29.8
<b>Shipping Dimensions</b>					
HxWxD (in.)	51.1" x 96" x 48"	51.1" x 96" x 48"	51.1" x 96" x 48"	51.1" x 96" x 48"	57.1" x 96" x 48"

**Notes:**

1. 6 - 10 ton and 20 - 25 ton condensing units are tested in accordance with AHRI Standard 365.
2. 12.5 and 15 ton condensing units are AHRI Certified to AHRI Standard 365.
3. 6 - 20 ton units are AHRI Certified to AHRI Standard 340-360 (I-P)-2007. Rating conditions are 95°F outdoor air temperature, 80°F entering dry bulb, 67°F entering wet bulb with 25ft of interconnecting refrigerant piping with minimum external static pressure as determined by rating standard.
4. 25 ton units are tested in accordance with AHRI Standard 340-360.

<sup>(a)</sup> Refer to refrigerant piping applications manual for line sizing and line length.

# Odyssey Split Cooling General Data

Table 9. General data — 5-7.5 tons (TWE0604\*A\*-TWE0904\*B\*) constant volume air handler — 60 Hz

	5 Tons	5 Tons	6 Tons	7.5 Tons	7.5 Tons
	Single Circuit TWE0604*A*	Dual Circuit TWE0604*B*	Dual Circuit TWE0724*B*	Single Circuit TWE0904*A*	Dual Circuit TWE0904*B*
<b>System Data</b>					
No. Refrigerant Circuits	1	2	2	1	2
Suction Line Connection (in.) OD	1-1/8	1-1/8	1-1/8	1-3/8	1-1/8
Liquid Line Connection (in.) OD	1/2	1/2	1/2	1/2	1/2
<b>Indoor Coil</b>					
Type	Lanced/Intertwined	Lanced/Intertwined	Lanced/Intertwined	Lanced/Intertwined	Lanced/Intertwined
Tube Size (in.)	0.375	0.375	0.375	0.375	0.375
Face Area (sq. ft.)	5	5	8.1	8.1	8.1
Rows/FPI (Fins per inch)	4/14	4/14	4/14	4/14	4/14
Refrigerant Control	Expansion Valve	Expansion Valve	Expansion Valve	Expansion Valve	Expansion Valve
Drain Connection Size (in.)	1 PVC	1 PVC	1 PVC	1 PVC	1 PVC
<b>Indoor Fan</b>					
Type	Centrifugal	Centrifugal	Centrifugal	Centrifugal	Centrifugal
No. Used/Diameter x Width (in.)	1/12 x 12	1/12 x 12	1/15 x 15	1/15 x 15	1/15 x 15
Drive Type/No. Speeds	Belt/Adjustable	Belt/Adjustable	Belt/Adjustable	Belt/Adjustable	Belt/Adjustable
CFM (Nominal)	2,000	2,000	2,400	3,000	3,000
No. Motors	1	1	1	1	1
Motor HP - Standard/Oversized	0.75/1.5	0.75/1.5	1.5/2.0/3.0	1.5/2.0/3.0	1.5/2.0/3.0
Motor RPM	1725	1725	1725	1725	1725
Motor Frame Size	56	56	56 H	56 H	56 H
<b>Filters<sup>(a)</sup></b>					
Type/Furnished	Throwaway/Yes	Throwaway/Yes	Throwaway/Yes	Throwaway/Yes	Throwaway/Yes
(No.)/Size Recommended	(1) 16 X 20 X 1 (1) 20 X 20 X 1	(1) 16 X 20 X 1 (1) 20 X 20 X 1	(3) 16 X 25 X 1	(3) 16 X 25 X 1	(3) 16 X 25 X 1
MERV 13 (No.)/Size Recommended	(1) 16 X 20 X 2 (1) 20 X 20 X 2	(1) 16 X 20 X 2 (1) 20 X 20 X 2	(3) 16 X 25 X 2	(3) 16 X 25 X 2	(3) 16 X 25 X 2
<b>Shipping Dimensions</b>					
HxWxD (in.)	55.1" x 27.5" x 43.5"	55.1" x 27.5" x 43.5"	61.2" x 30.5" x 53"	61.2" x 30.5" x 53"	61.2" x 30.5" x 53"

**Notes:**

1. Constant volume 6-15 ton ships wired for 208/230V, field convertible 460V.
  2. Oversized motor not available on 41A/B and 4KA/B models.
- (a) One inch, throw-away filters shall be standard on TWE0600, TWE072, TWE090, TWE120 model air handlers from the factory. The filter rack can be field converted to two inch capability. Two inch, throw-away filters shall be standard on TWE1804\*B and TWE2404\*B models.



# Odyssey Split Cooling General Data

**Table 10. General data — 10-25 tons (TWE1204\*A\*-TWE3004\*B\*) constant volume air handler — 60 Hz**

	10 Tons		10 Tons		12.5 Tons		15 Tons		20 Tons		25 Tons	
	Single Circuit TWE1204*A*	Dual Circuit TWE1204*B*	Single Circuit TWE1504*A*	Dual Circuit TWE1504*B*	Single Circuit TWE1804*A*	Dual Circuit TWE1804*B*	Single Circuit TWE2404*A*	Dual Circuit TWE2404*B*	Single Circuit TWE3004*A*	Dual Circuit TWE3004*B*	Single Circuit TWE3004*A*	Dual Circuit TWE3004*B*
<b>System Data</b>												
No. Refrigerant Circuits	1	2	2	2	2	2	2	2	2	2	2	2
Suction Line Connection (in.) OD	1-3/8	1-1/8	1-3/8	1-3/8	1-3/8	1-3/8	1-3/8	1-3/8	1-3/8	1-3/8	1-3/8	1-3/8
Liquid Line Connection (in.) OD	1/2	1/2	1/2	1/2	1/2	1/2	1/2	1/2	1/2	1/2	1/2	5/8
<b>Indoor Coil</b>												
Type	Lanced/Intertwined	Lanced/Intertwined	Lanced/Intertwined	Lanced/Intertwined	Lanced/Intertwined	Lanced/Intertwined	Lanced/Intertwined	Lanced/Intertwined	Lanced/Intertwined	Lanced/Intertwined	Lanced/Intertwined	Lanced/Face Split
Tube Size (in.)	0.375	0.375	0.375	0.375	0.375	0.375	0.375	0.375	0.375	0.375	0.375	0.375
Face Area (sq. ft.)	11.2	11.2	11.2	11.2	16.3	16.3	16.3	16.3	21.7	21.7	21.7	21.7
Rows/FPI (Fins per inch)	4/14	4/14	4/14	4/14	4/14	4/14	4/14	4/14	3/14	3/14	3/14	4/14
Refrigerant Control	Expansion Valve	Expansion Valve	Expansion Valve	Expansion Valve	Expansion Valve	Expansion Valve	Expansion Valve	Expansion Valve	Expansion Valve	Expansion Valve	Expansion Valve	Expansion Valve
Drain Connection Size (in.)	1 PVC	1 PVC	1 PVC	1 PVC	1 PVC	1 PVC	1 PVC	1 PVC	1 PVC	1 PVC	1 PVC	1 PVC
<b>Indoor Fan</b>												
Type	Centrifugal	Centrifugal	Centrifugal	Centrifugal	Centrifugal	Centrifugal	Centrifugal	Centrifugal	Centrifugal	Centrifugal	Centrifugal	Centrifugal
No. Used/Diameter x Width (in.)	1/15 x 15	1/15 x 15	1/15 x 15	1/15 x 15	2/15 x 15	2/15 x 15	2/15 x 15	2/15 x 15	2/15 x 15	2/15 x 15	2/15 x 15	2/15 x 15
Drive Type/No. Speeds	Belt/Adjustable	Belt/Adjustable	Belt/Adjustable	Belt/Adjustable	Belt/Adjustable	Belt/Adjustable	Belt/Adjustable	Belt/Adjustable	Belt/Adjustable	Belt/Adjustable	Belt/Adjustable	Belt/Adjustable
CFM (Nominal)	4,000	4,000	4,000	4,000	5,000	5,000	6,000	6,000	8,000	8,000	10,000	10,000
No. Motors	1	1	1	1	1	1	1	1	1	1	1	1
Motor HP - Standard/Oversized	2.0/3.0	2.0/3.0	2.0/3.0	2.0/3.0	2.0/3.0/5.0	3.0/5.0	3.0/5.0	3.0/5.0	3.0/5.0/7.5	3.0/5.0/7.5	7.5	7.5
Motor RPM	1725	1725	1725	1725	1755	1,728/1,750	1,750	1,750	1,750/3,470	1,750/3,470	3490	3490
Motor Frame Size	56 Hz	56 Hz	56 Hz	56 Hz	145T	56 Hz	56 Hz	56 Hz	184T	184T	184T	184T
<b>Filters<sup>(a)</sup></b>												
Type/Furnished	Throwaway/Yes	Throwaway/Yes	Throwaway/Yes	Throwaway/Yes	Throwaway/Yes	Throwaway/Yes	Throwaway/Yes	Throwaway/Yes	Throwaway/Yes	Throwaway/Yes	Throwaway/Yes	Throwaway/Yes
(No.)/Size Recommended	(4) 16 X 25 X 1	(4) 16 X 25 X 1	(4) 16 X 25 X 1	(4) 16 X 25 X 1	(8) 15 X 20 X 2	(8) 15 X 20 X 2	(8) 15 X 20 X 2	(8) 15 X 20 X 2	(4) 16 X 25 X 2	(4) 16 X 25 X 2	(4) 16 X 25 X 2	(4) 16 X 25 X 2
MERV 13 (No.)/Size Recommended	(4) 16 x 25 x 2	(4) 16 x 25 x 2	(4) 16 x 25 x 2	(4) 16 x 25 x 2	(8) 15 x 20 x 2	(8) 15 x 20 x 2	(8) 15 x 20 x 2	(8) 15 x 20 x 2	(4) 16 x 25 x 2	(4) 16 x 25 x 2	(4) 16 x 25 x 2	(4) 16 x 20 x 2
<b>Shipping Dimensions</b>												
HxWxD (in.)	61.2" x 30.5" x 69"	61.2" x 30.5" x 69"	61.2" x 30.5" x 69"	61.2" x 30.5" x 69"	76.3" x 33.3" x 85"	76.3" x 33.3" x 85"	76.3" x 33.3" x 85"	76.3" x 33.3" x 85"	79.1" x 35.8" x 95"	79.1" x 35.8" x 95"	79.1" x 35.8" x 95"	79.1" x 35.8" x 95"

**Notes:**  
 1. Constant volume 6-15 ton ships wired for 208/230V, field convertible 460V.  
 2. Oversized motor not available on 41A/B and 4KA/B models.  
 (a) One inch, throw-away filters shall be standard on TWE060, TWE072, TWE090, TWE120 model air handlers from the factory. The filter rack can be field converted to two inch capability. Two inch, throw-away filters shall be standard on TWE1804\*B and TWE2404\*B models.

# Odyssey Split Cooling General Data

**Table 11. General data — 6-10 tons (TWE072\*\*\*\*\* - TWE120\*\*\*\*\*) SZVAV and 2-speed VFD air handler — 60 Hz**

	<b>6 Tons Dual Circuit TWE07243B*, 4B*, WB*</b>	<b>7.5 Tons Dual Circuit TWE09043B*, 4B*, WB*</b>	<b>10 Tons Single Circuit TWE12043A*, 4A*, WA*</b>	<b>10 Tons Dual Circuit TWE12043B*, 4B*, WB*</b>
<b>Indoor Fan</b>				
Type	Centrifugal	Centrifugal	Centrifugal	Centrifugal
No. Used/Diameter x Width (in.)	1/15 x 15	1/15 x 15	1/15 x 15	1/15 x 15
Drive Type/No. Speeds	Belt/VFD Variable	Belt/VFD Variable	Belt/VFD Variable	Belt/VFD Variable
CFM (Nominal)	2,400	3,000	4,000	4,000
No. Motors	1	1	1	1
Motor HP - Standard/Oversized	2.0/3.0	2.0/3.0	2.0/3.0	2.0/3.0
Motor RPM	1725	1725	1725	1725
Motor Frame Size	56 Hz	56 Hz	56 Hz	56 Hz

**Table 12. General data — 12.5-25 tons (TWE150\*\*\*\*\* - TWE300\*\*\*\*\*) SZVAV and 2-speed VFD air handler — 60 Hz**

	<b>12.5 Tons Dual Circuit, TWE15043B*, 4B*, WB*</b>	<b>15 Tons Dual Circuit, TWE18043B*, 4B*, WB*</b>	<b>20 Tons Dual Circuit, TWE24043B*, 4B*, WB*</b>	<b>25 Tons Dual Circuit, TWE30043B*, 4B*, WB*</b>
<b>Indoor Fan</b>				
Type	Centrifugal	Centrifugal	Centrifugal	Centrifugal
No. Used/Diameter x Width (in.)	2/15 x 15	2/15 x 15	2/15 x 15	2/15 x 15
Drive Type/No. Speeds	Belt/VFD Variable	Belt/VFD Variable	Belt/VFD Variable	Belt/VFD Variable
CFM (Nominal)	5,000	6,000	8,000	10,000
No. Motors	1	1	1	1
Motor HP - Standard/Oversized	2.0/5.0	3.0/5.0	5.0/7.5	7.5 <sup>(a)</sup>
Motor RPM	1755/3450	1725/3450	3450/3470	3470
Motor Frame Size	56HZ	56HZ	56HZ/184T	184T

<sup>(a)</sup> Standard motor only

# Odyssey Split System Heat Pumps Selection Procedure

## Cooling Capacity

1. Calculate the building's total and sensible cooling loads at design conditions, using standardized calculation methods.
2. Size the equipment using the gross cooling capacity tables. Match the cooling loads at design conditions. For example, if the following specifies the building cooling requirements:  
 Electrical Characteristics: 460/60/3  
 Summer Design Conditions: Entering Evap Coil—80°F DB/67°F WB , Outdoor Ambient—95°F  
 Total Cooling Load: 82 MBh  
 Sensible Cooling Load: 60 MBh  
 Airflow: 3000 cfm  
 External Static Pressure: 0.77 inches of water gauge
3. Use Table 13, p. 30 to determine that TWA09043A with TWE09043A has a gross cooling capacity of 94.7 and 75.6 sensible capacity at 95°F DB ambient and 3000 cfm with 80°F DB/67°F WB air entering the evaporator.
4. To find the net cooling capacities, fan motor heat must be subtracted. Determine the total unit static pressure:  
 External Static Duct System: 0.77  
 Standard Filter: 0.10 in.  
 Supplementary Electric Heat: 0.23 in.  
 Total Static Pressure: 1.10 in.

### Notes:

- *The Evaporator Fan Performance Table has included the effect of a 1 in. filter already. Therefore, the actual Total Static Pressure is 1.10 - 0.10 = 1.00 in. . With 3000 cfm and 1.00 in., Table 38, p. 51 shows 1.97 Bhp (high static drive kit required).*
- *This formula can be used to calculate Fan Motor Heat:*  
 $3.15 \times \text{Bhp} = \text{MBh}$   
 $3.15 \times 1.97 = 6.2 \text{ MBh}$   
 $\text{Net Total Cooling Capacity} = 94.7 \text{ MBh} - 6.2 \text{ MBh} = 93.2 \text{ MBh}$   
 $\text{Net Sensible Cooling Capacity} = 75.6 \text{ MBh} - 6.2 \text{ MBh} = 75.6 \text{ MBh}$

## Heating Capacity

5. Calculate the building heating load using the American Standard calculation form or any other standard accepted method.
6. Size the equipment using Table 52, p. 63 to match the heating loads at design conditions. For example, if the following specifies the building heating requirements:  
 Total Heating Load: 95.0 MBh  
 Outdoor Ambient (Winter): 17°F DB  
 Indoor Return Temperature: 70°F DB  
 Airflow: 2625 cfm
7. Table 29, p. 45 indicates the mechanical heating portion of the heat pump will provide 54.3 MBh for the winter design conditions. Full heat load must be carried by the supplementary heater in the unlikely event the heat pump malfunctions. From Table 53, p. 63, the 34.88 kW heater at 460V has a capacity of 119,045. From , p. 73, the 34.88 kW heater at 460V indicates the heater model is BAYHTRL435.

# Odyssey Split System Heat Pumps Selection Procedure

---

## Air Delivery

1. The external static pressure drop through the air distribution system is 0.77 inches of water gauge, use Table 52, p. 63 to determine that the static pressure drop through the electric heater is 0.23 inches of water ( $0.77 + 0.23 = 1.00$  in.).
2. Enter Table 38, p. 51 for TWE09043A at 2625 cfm and 1.00 static pressure. The high static motor at 995 RPM gives the desired airflow.

ONLINE ONLY COPY

# Odyssey Split System Heat Pumps

## Model Number Description

### Heat Pump Condenser

#### Digit 1, 2, 3— Unit Function

**TWA** = Split System Heat Pump

#### Digit 4, 5, 6 — Tonnage

**072** = 6 Tons (60 Hz)  
**090** = 7.5 Tons (60 Hz)  
**120** = 10 Tons (60 Hz)  
**180** = 15 Tons (60 Hz)  
**240** = 20 Tons (60 Hz)

#### Digit 7 — Refrigerant

**4** = R-410A

#### Digit 8 — Voltage

**3** = 208-230 Vac - 3 PH (60Hz)  
**4** = 460 Vac - 3 PH (60Hz)  
**W** = 575 Vac - 3 PH (60Hz)  
**K** = 380 Vac - 3 PH (60Hz)

#### Digit 9 — Refrigeration Circuit/Stage

**A** = 1 Compressor/1 Line/1 Stage (Single)  
**D** = 2 Compressors/2 Line/2 Stage (Dual)

#### Digit 10 — Major Design Sequence

**A** = Rev A

#### Digit 11 — Minor Design Sequence

**A** = Rev A

#### Digit 12, 13 — Service Digits

\*\*

#### Digit 14 — Efficiency Generation

**A** = Generation A

#### Digit 15 — Controls

**S** = Symbio™

#### Digit 16 — None

**0** = None

#### Digit 17 — Coil Protection

**0** = Standard Coil  
**1** = Standard Coil w/ Hail Guard  
**2** = Black Epoxy Pre-Coated Condenser Coil (FIN/TUBE)  
**3** = Black Epoxy Pre-Coated Condenser Coil with Hail Guard (FIN/TUBE)

#### Digit 18, 19, 20 — None

**0** = None

#### Digit 21 — Communications Options

**0** = No Option  
**1** = Advanced Diagnostics and BACnet® BAS  
**2** = Advanced Diagnostics and LonTalk® Communications Interface (LCI)

#### Digit 22 to 40 — None

**0** = None

# Odyssey Split System Heat Pumps Model Number Description

## Air Handler

### Digit 1, 2, 3 – Unit Function

**TWE** = Air Handler

### Digit 4, 5, 6 – Tonnage

**060** = 5 Tons (60 Hz)  
**072** = 6 Tons (60Hz)  
**090** = 7.5 Tons (60 Hz)  
**120** = 10 Tons (60 Hz)  
**180** = 15 Tons (60 Hz)  
**240** = 20 Tons (60 Hz)

### Digit 7 – Refrigerant

**4** = R-410A

### Digit 8 – Voltage

**1** = 208-230 Vac - 1 PH (60 Hz)  
**3** = 208-230 Vac - 3 PH (60 Hz)  
**4** = 460 Vac - 3 PH (60 Hz)  
**W** = 575 Vac - 3 PH (60 Hz)  
**K** = 380 Vac - 3 PH (60Hz)

### Digit 9 – Refrigeration Circuit/Stage

**A** = Single Circuit  
**B** = Dual Circuit

### Digit 10 – Major Design Sequence

**A** = Rev A

### Digit 11 – Minor Design Sequence

**A** = Rev A

### Digit 12, 13 – Service Digits

\*\*

### Digit 14 – Efficiency Generation

**A** = Generation A (2018 DOE)

### Digit 15 – Controls

**1** = Constant Volume  
**C** = 2 Stage Airflow (Electromechanical Cond Only)  
**D** = 2 Stage Airflow/Single Zone VAV (Symbio Cond Only)

### Digit 16 – Indoor Fan Sizes

**0** = Standard Motor  
**4** = High Static – (Oversized Motor for VFD Units)

### Digit 17 to 40 – None

**0** = None

# Odyssey Split System Heat Pumps General Data

**Table 6. General data for 6 - 7.5 ton (TWA0724\*A\*-TWA0904\*D\*) heat pump units, 60 Hz**

	6 Tons Single Comp TWA0724*A*	6 Tons Dual Comp TWA0724*D*	7.5 Tons Single Comp TWA0904*A*	7.5 Tons Dual Comp TWA0904*D*
<b>Cooling Performance - Gross Cooling Capacity</b>				
Matched Air Handler	TWE0904*A*	TWE0724*B*	TWE0904*A*	TWE0904*B*
AHRI Rated Airflow	2,400	2,400	3,000	3,000
Gross Cooling Capacity - System	82,000	78,000	95,000	96,000
Condensing Unit Only	76,000	71,000	88,000	88,000
AHRI Net Cooling Capacity	80,000	77,000	92,000	93,000
<b>Efficiency</b>				
Matched Air Handler (EER)	11.3	11.2	11.3	11.2
Condensing Unit Only (EER)	13.0	12.7	11.0	12.8
System (IEER)	12.4	12.2	12.4	12.2
System kW/Condensing Unit kW	6.4 / 5.9	6.1 / 5.6	8.0 / 7.3	7.6 / 6.8
<b>Heating Performance - AHRI Htg/ Matched AH</b>				
High Temperature Capacity	72,000	64,000	87,000	82,000
System kW/COP	5.79 / 3.3	5.08 / 3.3	6.49 / 3.3	6.36 / 3.3
Low Temperature Capacity	46,000	38,000	45,500	51,500
System kW/COP	5.38 / 2.25	4.69 / 2.25	6.32 / 2.2	6.04 / 2.25
<b>Compressor</b>				
Type	Scroll	Scroll	Scroll	Scroll
No./Tons	1/5.6	2/2.6	1/6.8	2/3.25
<b>System Data</b>				
No. Refrigerant Circuits <sup>(a)</sup>	1	2	1	2
Suction Line Connection (in.) OD <sup>(a)</sup>	1 3/8	7/8	1 3/8	1 1/8
Liquid Line Connection (in.) OD <sup>(a)</sup>	1/2	1/2	1/2	1/2
<b>Outdoor Coil</b>				
Type / Tube Size (in.) OD	Lanced / 0.375	Lanced / 0.375	Lanced / 0.375	Lanced / 0.375
Face Area (sq ft)	19.24	19.24	19.24	23.96
Rows/FPI (Fins per inch)	2/18	2/18	2/18	2/18
<b>Outdoor Fan</b>				
Type	Propeller	Propeller	Propeller	Propeller
No. Used/Diameter (in.)	1/26	1/26	1/26	1/26
Drive Type/No. Speeds	Direct/1	Direct/1	Direct/1	Direct/1
CFM	6,530	6,530	6,530	6,530
No. Motor/HP	1/0.5	1/0.5	1/0.5	1/0.5
Motor RPM	1,100	1,100	1,100	1,100
<b>Refrigerant Charge (Field Supplied)</b>				
lbs of R-410A	20.4	11.0/11.0	19.0	11.8/11.8
<b>Shipping Dimensions</b>				
HxWxD (in.)	45" x 45" x 38"	45" x 55" x 42"	45" x 45" x 38"	45" x 55" x 42"

<sup>(a)</sup> Refer to refrigerant piping applications manual for line sizing and line length.

# Odyssey Split System Heat Pumps General Data

**Table 7. General data for 10 - 20 ton (TWA1204\*A\*-TWA2404\*D\*) heat pump units, 60 Hz**

	10 Tons Single Comp TWA1204*A*	10 Tons Dual Comp TWA1204*D*	15 Tons Dual Comp TWA1804*D*	20 Tons Dual Comp TWA2404*D*
<b>Cooling Performance - Gross Cooling Capacity</b>				
Matched Air Handler	TWE1204*A*	TWE1204*B*	TWE1804*B*	TWE2404*B*
AHRI Rated Airflow	4,000	3,500	6,000	8,000
Gross Cooling Capacity - System	127,000	120,000	194,000	258,000
Condensing Unit Only	117,000	115,000	176,000	276,000
AHRI Net Cooling Capacity	123,000	118,000	188,000	248,000
<b>Efficiency</b>				
Matched Air Handler (EER)	11.3	11.2	10.8	10.0
Condensing Unit Only (EER)	12.5	12.6	11.9	12.8
System (IEER)	12.4	12.2	11.6	10.6
System kW/Condensing Unit kW	10.6 / 9.4	9.9 / 9.1	17 / 14.8	24 / 21.6
<b>Heating Performance - AHRI Htg/Matched AH</b>				
High Temperature Capacity	120,000	112,000	178,000	238,000
System kW/COP	9.92 / 3.3	8.98 / 3.3	15.67 / 3.2	21.5 / 3.2
Low Temperature Capacity	76,000	71,000	117,000	148,000
System kW/COP	9.30 / 2.25	8.29 / 2.25	14.21 / 2.05	19.1 / 2.05
<b>Compressor</b>				
Type	Scroll	Scroll	Scroll	Scroll
No./Tons	1/8.6	2/4.3	2/6.9	2/10.1
<b>System Data</b>				
No. Refrigerant Circuits <sup>(a)</sup>	1	2	2	2
Suction Line Connection (in.) OD <sup>(a)</sup>	1 3/8	1 1/8	1 1/8	1 3/8
Liquid Line Connection (in.) OD <sup>(a)</sup>	1/2	1/2	1/2	5/8
<b>Outdoor Coil</b>				
Type / Tube Size (in.) OD	Lanced / 0.375	Lanced / 0.375	Lanced / 0.375	Lanced / 0.375
Face Area (sq ft)	29.02	29.02	52.60	52.60
Rows/FPI (Fins per inch)	2/18	2/18	2/18	2/18
<b>Outdoor Fan</b>				
Type	Propeller	Propeller	Propeller	Propeller
No. Used/Diameter (in.)	1/28	1/28	2/28	2/28
Drive Type/No. Speeds	Direct/1	Direct/1	Direct/1	Direct/1
CFM	9,800	9,800	19,500	19,500
No. Motor/HP	1/1	1/1	2/1	2/1
Motor RPM	1,125	1,125	1,125	1,125
<b>Refrigerant Charge (Field Supplied)</b>				
lbs of R-410A	34.7	14.0/14.0	27.2/24.5	23.5/23.5
<b>Shipping Dimensions</b>				
HxWxD (in.)	52.1" x 55" x 42"	52.1" x 55" x 42"	51.1" x 96" x 48"	51.1" x 96" x 48"

<sup>(a)</sup> Refer to refrigerant piping applications manual for line sizing and line length.



# Odyssey Split System Heat Pumps General Data

**Table 8. General data — 5-7.5 tons (TWE0604\*A\*-TWE0904\*B\*) standard air handler — 60 Hz**

	5 Tons		6 Tons		7.5 Tons	
	Single Circuit TWE0604*A*	Dual Circuit TWE0604*B*	Dual Circuit TWE0724*B*	Single Circuit TWE0904*A*	Dual Circuit TWE0904*B*	
<b>System Data</b>						
No. Refrigerant Circuits	1	2	2	1	2	
Suction Line Connection (in.) OD	1-1/8	1-1/8	1-1/8	1-3/8	1-1/8	
Liquid Line Connection (in.) OD	1/2	1/2	1/2	1/2	1/2	
<b>Indoor Coil</b>						
Type	Lanced/Intertwined	Lanced/Intertwined	Lanced/Intertwined	Lanced/Intertwined	Lanced/Intertwined	
Tube Size (in.)	0.375	0.375	0.375	0.375	0.375	
Face Area (sq. ft.)	5	5	8.1	8.1	8.1	
Rows/FPI (Fins per inch)	4/14	4/14	4/14	4/14	4/14	
Refrigerant Control	Expansion Valve	Expansion Valve	Expansion Valve	Expansion Valve	Expansion Valve	
Drain Connection Size (in.)	1 PVC	1 PVC	1 PVC	1 PVC	1 PVC	
<b>Indoor Fan</b>						
Type	Centrifugal	Centrifugal	Centrifugal	Centrifugal	Centrifugal	
No. Used/Diameter x Width (in.)	1/12 x 12	1/12 x 12	1/15 x 15	1/15 x 15	1/15 x 15	
Drive Type/No. Speeds	Belt/Adjustable	Belt/Adjustable	Belt/Adjustable	Belt/Adjustable	Belt/Adjustable	
CFM (Nominal)	2,000	2,000	2,400	3,000	3,000	
No. Motors	1	1	1	1	1	
Motor HP - Standard/Oversized	0.75/1.5	0.75/1.5	1.5/2.0/3.0	1.5/2.0/3.0	1.5/2.0/3.0	
Motor RPM	1725	1725	1725	1725	1725	
Motor Frame Size	56	56	56 H	56 H	56 H	
<b>Filters<sup>(a)</sup></b>						
Type/Furnished	Throwaway/Yes	Throwaway/Yes	Throwaway/Yes	Throwaway/Yes	Throwaway/Yes	
(No.)/Size Recommended	(1) 16 x 20 x 1 (1) 20 x 20 x 1	(1) 16 x 20 x 1 (1) 20 x 20 x 1	(3) 16 x 25 x 1	(3) 16 x 25 x 1	(3) 16 x 25 x 1	
MERV 13 (No.)/Size Recommended	(1) 16 x 20 x 2 (1) 20 x 20 x 2	(1) 16 x 20 x 2 (1) 20 x 20 x 2	(3) 16 x 25 x 2	(3) 16 x 25 x 2	(3) 16 x 25 x 2	
<b>Shipping Dimensions</b>						
HxWxD (in.)	55.1" x 27.5" x 43.5"	55.1" x 27.5" x 43.5"	61.2" x 30.5" x 53"	61.2" x 30.5" x 53"	61.2" x 30.5" x 53"	

**Notes:**

- Constant volume 6-15 ton ships wired for 208/230V, field convertible 460V.
  - Oversized motor not available on 41A/B and 4KA/B models.
- (a) One inch, throw-away filters shall be standard on TWE060, TWE072, TWE090, TWE120 model air handlers from the factory. The filter rack can be field converted to two inch capability. Two inch, throw-away filters shall be standard on TWE1804\*B and TWE2404\*B models.

# Odyssey Split System Heat Pumps General Data

**Table 9. General data — 10-20 tons (TWE1204\*A\*.TWE2404\*B\*) standard air handler — 60 Hz**

	10 Tons	10 Tons	15 Tons	20 Tons
<b>System Data</b>				
No. Refrigerant Circuits	1	2	2	2
Suction Line Connection (in.) OD	1-3/8	1-1/8	1-3/8	1-3/8
Liquid Line Connection (in.) OD	1/2	1/2	1/2	1/2
<b>Indoor Coil</b>				
Type	Lanced/Intertwined	Lanced/Intertwined	Lanced/Intertwined	Lanced/Intertwined
Tube Size (in.)	0.375	0.375	0.375	0.375
Face Area (sq. ft.)	11.2	11.2	16.3	21.7
Rows/FPI (Fins per inch)	4/14	4/14	4/14	3/14
Refrigerant Control	Expansion Valve	Expansion Valve	Expansion Valve	Expansion Valve
Drain Connection Size (in.)	1 PVC	1 PVC	1 PVC	1 PVC
<b>Indoor Fan</b>				
Type	Centrifugal	Centrifugal	Centrifugal	Centrifugal
No. Used/Diameter x Width (in.)	1/15 x 15	1/15 x 15	2/15 x 15	2/15 x 15
Drive Type/No. Speeds	Belt/Adjustable	Belt/Adjustable	Belt/Adjustable	Belt/Adjustable
CFM (Nominal)	4,000	4,000	6,000	8,000
No. Motors	1	1	1	1
Motor HP - Standard/Oversized	2.0/3.0	2.0/3.0	3.0/5.0	3.0/5.0/7.5
Motor RPM	1725	1725	1,728/1,750	1,750/3,470
Motor Frame Size	56 Hz	56 Hz	56 Hz	184T
<b>Filters<sup>(a)</sup></b>				
Type/Furnished	Throwaway/Yes	Throwaway/Yes	Throwaway/Yes	Throwaway/Yes
(No.)/Size Recommended	(4) 16 X 25 X 1	(4) 16 X 25 X 1	(8) 15 X 20 X 2	(4) 16 X 25 X 2 (4) 16 X 20 X 2
MERV 13 (No.)/Size Recommended	(4) 16 x 25 x 2	(4) 16 x 25 x 2	(8) 15 x 20 x 2	(4) 16 x 25 x 2 (4) 16 x 20 x 2
<b>Shipping Dimensions</b>				
HxWxD (in.)	61.2" x 30.5" x 69"	61.2" x 30.5" x 69"	76.3" x 33.3" x 85"	79.1" x 35.8" x 95"

**Notes:**

1. Constant volume 6-15 ton ships wired for 208/230V, field convertible 460V.
  2. Oversized motor not available on 41A/B and 4KA/B models.
- <sup>(a)</sup> One inch, throw-away filters shall be standard on TWE060, TWE072, TWE090, TWE120 model air handlers from the factory. The filter rack can be field converted to two inch capability. Two inch, throw-away filters shall be standard on TWE1804\*B and TWE2404\*B models.

# Odyssey Split System Heat Pumps General Data

**Table 10. General data — 6-20 tons (TWE0724\*B\* - TWE2404\*B\*) SZVAV and 2-speed VFD air handler — 60 Hz**

	6 Tons	7.5 Tons	10 Tons	10 Tons	15 Tons	20 Tons
<b>Indoor Fan</b>						
Type	Centrifugal	Centrifugal	Centrifugal	Centrifugal	Centrifugal	Centrifugal
No. Used/Diameter x Width (in.)	1/15 x 15	1/15 x 15	1/15 x 15	1/15 x 15	2/15 x 15	2/15 x 15
Drive Type/No. Speeds	Belt/VFD Variable	Belt/VFD Variable	Belt/VFD Variable	Belt/VFD Variable	Belt/VFD Variable	Belt/VFD Variable
CFM (Nominal)	2,400	3,000	4,000	4,000	6,000	8,000
No. Motors	1	1	1	1	1	1
Motor HP - Standard/Oversized	2.0/3.0	2.0/3.0	2.0/3.0	2.0/3.0	3.0/5.0	5.0/7.5
Motor RPM	1725	1725	1725	1725	1725/3450	3450/3470
Motor Frame Size	56 Hz	56 Hz	56 Hz	56 Hz	56 Hz	56 Hz/184T
	Dual Circuit TWE07243B*, 4B*, WB*	Dual Circuit TWE09043B*, 4B*, WB*	Single Circuit TWE12043A*, 4A*, WA*	Dual Circuit TWE12043B*, 4B*, WB*	Dual Circuit, TWE18043B*, 4B*, WB*	Dual Circuit, TWE24043B*, 4B*, WB*

ONLINE COPY



# WE OBSESS OVER IT. SO YOU DON'T.

BUILT TO A HIGHER STANDARD

*American Standard*  
HEATING & AIR CONDITIONING

About American Standard Heating and Air Conditioning  
American Standard has been creating comfortable and affordable living environments for more than a century.  
For more information, please visit [www.americanstandardair.com](http://www.americanstandardair.com).  
© 2021 American Standard Heating and Air Conditioning. 01/22

14-1011-39

We are committed to using environmentally friendly printing practices.