



# TOP 10 REASONS TO CONNECT WITH NEXIA.

1.

## MORE OPTIONS TO COVER EVERY BUDGET.

We've added the Silver 624, Gold 824, and AccuLink™ Platinum 850 to round out our portfolio of connected controls and make it possible for you to offer a connected control to suit every system you install. Selling connected home products all year long during service calls helps create customer leads to sell HVAC equipment down the road.



Nexia Remote Climate Access is included with the purchase of a connected control. Adding accessories to your Nexia system requires a monthly subscription for remote access via most web-enabled smartphones and computers.

## MORE NEXIA™ DIAGNOSTICS ON THE WAY.

We continue to innovate and update Nexia™ Diagnostics to provide you with additional opportunities. Dealers installing connected controls today will benefit from future enhancements that will improve efficiency, effectiveness, and productivity, all while increasing customer loyalty and service opportunities. Every connected control sold and installed now can mean additional income in the future.



Future Dealer Opportunity: Nexia will offer real time performance data for every connected control a dealer installs, allowing the potential for proactive customer service if needed.

## IT'S YOUR MARKET. IT WON'T GROW ITSELF.

While you may only sell an HVAC system to a customer every 10 to 12 years, you can sell Nexia-enabled products every day, every year, all year round. Not only will this improve your margins, it can also drive ongoing accessory sales and help you sell a new system when the time comes.



Nexia Control Advantage: Customers will see your dealer logo and contact information inside the Nexia portal, keeping you top of mind if they need service, replacement, expansion, or better still, when they show off to friends.

## TRAINING AND SALES TOOLS.

We have training and sales tools to help you at the kitchen table. As an American Standard Heating & Air Conditioning dealer, you sell products you believe in. That's why we are committed to providing you the knowledge and tools to believe in Nexia.

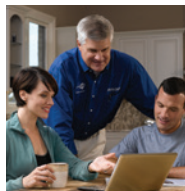

Nexia Team Goal: Equip dealers with the training, tools, and confidence to sell Nexia.

## INTEGRATED MARKETING ASSETS.

New marketing collateral has been created to give you a choice of materials to fit your business strategy for presale, selling, and after sale support.

We have also integrated Nexia into MAX so you can customize your own local marketing effort easily, create excitement with your homeowners, and market connected controls.



Nexia Team Goal: Make it easy and worthwhile for you to market connected controls on every sales and service call.

6.

## HOMEOWNER AND DEALER SUPPORT.

You're all about customer satisfaction and exceeding expectations. So if you are going to sell Nexia-enabled products to your customers, you want to be sure they get quality support. Our support team will provide knowledgeable, courteous support for your customers, and for you as a dealer 7 days a week. That's why they are the key to helping homeowners with technical questions and keeping them from landing in your lap.



Nexia Best In Class Support: A dedicated team, based right here in the US, and thoroughly trained in technology and connected products. They're out to earn your customers' trust. We suggest you find out for yourself. Give them a call when you hook up your own Nexia system.

## MARKETS ARE GROWING AT A RAPID PACE.

Homeowners are becoming increasingly interested in a connected lifestyle. They want to use their mobile devices to make their lives easier, and to connect to the things that matter most to them like their homes and families. They also want choice and flexibility. With the capability to be connected with a wide variety of products from other leading brands, Nexia offers exactly what they want. You are in a unique position to introduce them to Nexia, and to benefit from the projected growth in the home automation and control system market.

7.

## STAND OUT FROM THE COMPETITION.

Taking the lead in selling connected controls makes you stand out as a leader in the industry, lets you control your own destiny, and creates customers for life, customers with more reasons to trust you when they need HVAC products. Embracing advanced technology and providing leadership to your customers with regards to a connected home is not the future anymore, it's now. In fact, the numbers suggest they will be seeking advice in this category. The more you know, the more you will be able to help them. How many connected devices do you own?

8.

## SCALABILITY ALLOWS YOU TO ADOPT GRADUALLY.

You choose where to start with Nexia. At a minimum, put a Nexia-enabled American Standard Heating & Air Conditioning control in with every system you install. When you are more comfortable with connected home product integration, start building new revenue streams and service offerings. You decide how far you want to go.

9.

## 20 BILLION MORE REASONS WHY WE'RE COMMITTED.

By 2020, the global home automation and control market will be worth \$21.6 billion, up from just \$4.4 billion in 2013.\* Our commitment is to help you grow your business with this opportunity by consistently improving and expanding our portfolio of home automation products, and providing you with the support you need to make Nexia part of your everyday offering to your customers.

\*SOURCE: Transparency Market Research

10.



American Standard Heating & Air Conditioning with Nexia: Creates the ultimate smart home systems and we want you to be part of this ground breaking connection.



# Contents - Residential

Model Nomenclature ..... TOC-6

**Connected Home Solutions**

- Conventional 24 Volt Connected Controls..... CHS-1
- AccuLink™ Communicating Connected Controls ..... CHS-2
- NEXIA Bridges & Starter Bundles..... CHS-3
- NEXIA Compatible Products..... CHS-4
- Home Energy Management eMonitor™ Hardware & Accessories ..... CHS-12

**Split System Cooling**

- AccuComfort™ Variable Speed Single Phase, 2-5 Tons (4A7V0, 4A7V8)..... SC-1
- Single Phase, 1½-5 Tons (4A7A7, 4A7A6) ..... SC-3
- Single Phase, 1.5-5 Tons (4A7A4, 4A7A3) ..... SC-5
- Single, Three Phase, and R-22 (4TTB3, 4TTA3, 2TTB3) ..... SC-7

**Split System Heat Pumps**

- Summary of System Ratings ..... SH-1
- AccuComfort™ Variable Speed Single Phase, 2-5 Tons (4A6V0, 4A6V8)..... SH-3
- Single Phase, 1½-5 Tons (4A6H7, 4A6H6, 4A6H5, 4A6H4) ..... SH-5
- Single and Three Phase (4TWB3, 4TWA3) ..... SH-7

**Air Handlers/Heaters**

- Multi-position Chart..... AH-1
- Features and Benefits..... AH-2
- Series 7 & 8 Variable Speed Multi-Position, 2-5 Tons (TAM8, TAM7)..... AH-3
- Series 4 Multi-Position, Single Phase, 1½-5 Tons (TAM4) ..... AH-6
- Series 5 Multi-Position, Single Phase, 1½-5 Tons (GAM5) ..... AH-8
- Series 2 Split System, Single Phase, 1½-5 Tons (GAF2, GAM2) ..... AH-10
- Heaters for Multi-Position ..... AH-12
- TEM Split System, Single Phase, 1½-5 Tons (TEM6, TEM4, TEM3)..... AH-15
- Heaters for TEM..... AH-17
- TMM Wall, Stud, or Over the Water Heater, Single Phase, 1½-5 Tons (TMM5, TMM4) ..... AH-19
- 4FW ..... AH-20
- 4FW Heaters..... AH-22

**Coils**

- Split System Aluminum Cased Heat Pump and Cooling (4TXC-DS, 4TXC-CC, 4TXC-BC, 4NXC-AS) ..... COIL-1
- Split System Aluminum Cased Heat Pump and Cooling (4NXC-AC, 4PXC-U)..... COIL-2
- Split System Aluminum Cased Heat Pump and Cooling (4PXC-D)..... COIL-3
- Split System Aluminum Uncased Heat Pump and Cooling (4TXA-BC, 4NXA-AC) ..... COIL-4
- Split System Aluminum Uncased Heat Pump and Cooling (4PXA-U) ..... COIL-5
- Split System Aluminum Cased Heat Pump and Cooling (4CXC-CC, 4CXC-DC, 4TXF) ..... COIL-6
- Split System Cased/Uncased Coil Features ..... COIL-7
- 4GXC Cased Heat Pump and Cooling..... COIL-8
- 4FX Series Cased & Uncased Cooling (4FXC, 4FXA) ..... COIL-9
- 4FX Flat & Horizontal Cooling (4FXFH, 4FXCH) ..... COIL-10

.....

This publication is for general reference information only and is not intended for systems equipment / combination selections.

Products listed in this book are not always carried in factory/distributor inventory, nor are all products available through all distribution channels. Consult your Distributor for availability and shipping information.

Since American Standard Heating & Air Conditioning has a policy of continuous product improvement, it reserves the right to change design and specification without notice.

.....

## Contents - Residential

### Furnaces

- S9V2 Two Stage Variable Speed ..... FUR-1
- Platinum 95, Gold 95v, Gold 95, Silver 95, Silver 95h & American Standard 92  
Airflow Directions ..... FUR-3
- Platinum 95 Modulating Communicating Variable Speed (AUHM, ADHM) ..... FUR-4
- Gold 95v Two Stage Variable Speed (AUH2, ADH2) ..... FUR-4
- Gold 95 Two Stage (AUH2, ADH2) ..... FUR-5
- Silver 95 Single Stage (AUH1, ADH1) ..... FUR-5
- Silver 95h Single Stage w/ High Efficiency Motor (AUH1-H, ADH1-H) ..... FUR-6
- American Standard 92 Single Stage (AUC1, ADC1) ..... FUR-6
- Platinum 95, Gold 95v, Gold 95, Silver 95, Silver 95h & American Standard 92  
Features & Accessories ..... FUR-7
- Special Use Furnace Accessories ..... FUR-9
- Platinum 80, Gold 80v, Gold 80, Silver 80h, Silver 80 & American Standard 80  
Airflow Directions ..... FUR-10
- Platinum 80 Two Stage Variable Speed (AUD2-ACV, ADD2-ACV) ..... FUR-11
- Gold 80v Two Stage Variable Speed (AUD-A-V-V, ADD-A-V-V) ..... FUR-11
- Gold 80 Two Stage (AUD2, ADD2) ..... FUR-12
- Silver 80h Single Stage w/ High Efficiency Motor (AUD1-H, ADD1-H) ..... FUR-12
- Silver 80 Single Stage (AUD1, ADD1) ..... FUR-13
- American Standard 80 Single Stage (AUE1, ADE1) ..... FUR-14
- Platinum 80, Gold 80v, Gold 80, Silver 80h, Silver 80 & American Standard 80  
Features & Accessories ..... FUR-15
- Special Use Furnace Accessories ..... FUR-16
- High Efficiency Oil Furnaces Ordering Information ..... FUR-17

### Indoor Air Quality

- AccuClean™ Whole Home Air Cleaner (AFD) ..... IAQ-1
- Perfect Fit™ Media Filters (TFM) ..... IAQ-2
- Perfect Fit™ Filter Accessories ..... IAQ-3
- AccuClean™ Dimensions ..... IAQ-4
- Humidifiers Fan Powered and Bypass ..... IAQ-6
- Energy Recovery Ventilator (ERV) ..... IAQ-9

### Comfort Controls/Zone Sensors

- Conventional 24 Volt Connected Controls ..... CCZS-1
- AccuLink™ Communicating Connected Controls ..... CCZS-2
- Zoning AccuLink™ Platinum 950 Control Features (AZONE950) ..... CCZS-4
- Zoning Communicating Sensor with Display Features (AZONE940) ..... CCZS-5
- Conventional 24 Volt HVAC System Interface Relay Panel for  
AccuLink™ Platinum 950 Control ..... CCZS-6
- AccuLink™ Platinum 950 Control Component Overview ..... CCZS-7
- AccuLink™ Zoning Assembly & Zone Expander Panel ..... CCZS-8
- AccuLink™ Zoning Component Overview ..... CCZS-9
- 24 Volt Modulating Dampers ..... CCZS-11
- Programmable 7 Day ..... CCZS-16
- Programmable 5/2 Day ..... CCZS-17
- Non-Programmable ..... CCZS-18
- Remote Sensors ..... CCZS-19
- Indoor Fan Delay Relay Kit & Outdoor Thermostat Kit ..... CCZS-20

# Contents - Residential

## Packaged Units

- Cooling Convertible, 2-5 Tons (4TCY5, 4TCY4) ..... PK-1
- Cooling Convertible, 2-5 Tons (4TCX3, 4TCC4, 4TCC3)..... PK-4
- Heating Convertible Dual Fuel, 2-5 Tons (4WCZ6, 4DCZ6, 4DCY4)..... PK-7
- Heating Convertible, 2-5 Tons (4WCY5, 4WCY4)..... PK-10
- Heating Convertible, 2-5 Tons (4WCC4, 4WCX3, 4WCC3)..... PK-13
- Heating Over/Under 2-5 Tons (4WHC4) ..... PK-16
- Gas/Electric Convertible, 2-5 Tons (4YCY6, 4YCY4)..... PK-17
- Gas/Electric Convertible, 2-5 Tons (4YCY5) ..... PK-18
- Gas/Electric Convertible, 3-5 Tons (4YCX3) ..... PK-20
- Gas/Electric Convertible, 2-5 Tons (4YCC4, 4YCC3) ..... PK-21
- Convertible, 2-5 Tons Single Power Entry Kits..... PK-24
- Convertible, 2-5 Tons Supplemental Heaters..... PK-25

## Geothermal

- Variable Speed Packaged Units (AVGX)..... GEO-1
- Water to Air Packaged Units (1GX-2GX, 2GC)..... GEO-4
- Water to Water Packaged Units (1GW, 2GW)..... GEO-9
- HydroLogic™ Control..... GEO-12
- Triple Function Hybrid Water to Air Systems (GY)..... GEO-13
- Split Heat Pump Units (2GN, GE)..... GEO-15
- Air Handlers and Coils (TAMG, AGA, GCX)..... GEO-18
- Standard Accessories ..... GEO-22

## Ductless

- Single Zone Pro Series Single Phase, ½-4 Tons  
(4TXU, 4UXD, 4UXC, 4UXL, 4UXX) ..... DU-1
- Single Zone Single Phase, ¾-3 Tons (4TXK, 4MXW)..... DU-3
- Single Zone Single Phase, ¾-3 Tons (4TYK, 4MYW, 4TXK, 4MXW) ..... DU-4
- Multi-Zone Single Phase, 1½-3½ Tons  
(4TXM, 4MXW, 4MXC, 4MXL, 4MXF)..... DU-6
- Multi-Zone Single Phase, 1½-3½ Tons (4MXD, 4MXX) ..... DU-7
- Multi-Zone Single Phase, 1½-3½ Tons  
(4TXM, 4MXW, 4MXC, 4MXL, 4MXF, 4MXD, 4MXX)..... DU-8
- AccuFlex™ VRF Indoor Units ..... DU-10
- AccuFlex™ VRF Model Control Units (MCU) ..... DU-13
- AccuFlex™ VRF Outdoor Units ..... DU-13
- AccuFlex™ VRF Unit Controls & EEV Kit Application Table ..... DU-15
- AccuFlex™ VRF Unit Accessories..... DU-16

## Accessories/Information

- Roof Curbs (BAYCURB050A, BAYCURB051A) ..... AC/IN-1
- Thermal Expansion Valves..... AC/IN-2
- Equipment Date Identification ..... AC/IN-4
- Refrigerant Line Sets ..... AC/IN-5
- Refrigerant HFC 410A (R-410A)..... AC/IN-6
- Refrigerant Piping Information for Two Stage Split Systems..... AC/IN-7
- Split systems with Variable Speed Compressor..... AC/IN-8
- Branch Circuit Wire Sizing Table/Heater De-Rating Chart ..... AC/IN-11
- Basic Air Conditioning Formulas..... AC/IN-12
- Low Ambient Accessories, Cooling & Heating Models ..... AC/IN-13
- Wind Shields..... AC/IN-14

# Contents - Light Commercial

Model Nomenclature .....	LTOC-15
<b>Split System Cooling</b>	
• Three Phase, 6-25 Tons, R-410A (TTA) .....	LSC-1
• Three Phase, 6-25 Tons, R-22 (TTA) .....	LSC-2
• Three Phase, 6-25 Tons, R-410A (TTA) .....	LSC-3
• ReliaTel™ Controls, 6-25 Tons - Protection/Operation Timings and Features .....	LSC-6
<b>Split System Heat Pumps</b>	
• Three Phase, 6-20 Tons, R-410A (TWA) .....	LSH-1
• Three Phase, 7.5-20 Tons, R-22 (TWA) .....	LSH-2
• ReliaTel™ Controls, 6-20 Tons - Protection/Operation Timings and Features .....	LSH-5
<b>Air Handlers/Heaters</b>	
• Single Phase 5-10 Tons (TWE) .....	LAH-1
• Three Phase 5-25 Tons (TWE) .....	LAH-1
<b>Comfort Controls/Zone Sensors</b>	
• Non-Programmable for ReliaTel™ Units .....	LCCZS-1
• Programmable for ReliaTel™ Units .....	LCCZS-1
• Zone Sensor Unit Installation .....	LCCZS-3
• Micro Control Zone Sensors .....	LCCZS-4
• Electronic Programmable Zone Sensors for ReliaTel™ Units .....	LCCZS-5
• Integrated Comfort™ Systems Sensors for ReliaTel™ Units .....	LCCZS-5
<b>Packaged Cooling</b>	
• Convertible, 3-10 Tons Features .....	LPC-1
• Convertible, 3-5 Tons, R-410A (THC, TSC) .....	LPC-2
• Convertible, 3-5 Tons, R-410A (TSC) .....	LPC-3
• Convertible, 6-10 Tons, R-410A (THC, TSC) .....	LPC-4
• Convertible, 3-10 Tons Model Digit Numbers .....	LPC-5
• Convertible, 3-10 Tons, R-410A Electric Heaters .....	LPC-7
• Convertible, 6-10 Tons, R-410A Electric Heaters .....	LPC-8
• Convertible, 3-10 Tons Accessories .....	LPC-11
• Convertible, 3-10 Tons Zone Sensors/Thermostats .....	LPC-13
• ReliaTel™ Controls (Packaged Unit Protection/Operation Timings & Features) .....	LPC-14
• ReliaTel™ Controls (Operation with an Electromechanical Thermostat) .....	LPC-15
• Packaged Cooling with ReliaTel™ Controls, 12½-25 Tons, R-410A (T*D-F/T*H-F) .....	LPC-16
• Packaged Cooling with ReliaTel™ Controls, 12½-25 Tons Model Digit Numbers .....	LPC-18
• Packaged Cooling with ReliaTel™ Controls, 12½-25 Tons Zone Sensors/Thermostats .....	LPC-19
• Packaged Cooling with ReliaTel™ Controls, 12½-25 Tons Accessories .....	LPC-20
• Packaged Cooling with ReliaTel™ Controls, 12½-25 Tons Heaters .....	LPC-22
• Foundation™ Packaged Cooling, 15-25 Tons, R-410A (EAC) .....	LPC-24
• Foundation™ Packaged Cooling, 15-25 Tons, R-410A Accessories .....	LPC-25
• Foundation™ Packaged Cooling, 15-25 Tons, R-410A Heaters .....	LPC-26
<b>Packaged Heat Pump</b>	
• Convertible, 3-10 Tons Features .....	LPH-1
• Convertible, 3-10 Tons (WSC) .....	LPH-2
• Convertible, 3-10 Tons Model Digit Numbers .....	LPH-3
• Convertible, 3-5 Tons, Electric Heaters .....	LPH-5
• Convertible, 6-10 Tons Electric Heaters & Zone Sensors .....	LPH-6
• Convertible, 3-10 Tons Accessories .....	LPH-7
• Packaged Heat Pump with ReliaTel™ Controls, 12½-20 Tons (WSD/WSH) .....	LPH-9
• Packaged Heat Pump with ReliaTel™ Controls, 12½-20 Tons Model Digit Numbers .....	LPH-10
• Packaged Heat Pump with ReliaTel™ Controls, 12½-20 Tons Zone Sensors .....	LPH-11
• Packaged Heat Pump with ReliaTel™ Controls, 12½-20 Tons Accessories .....	LPH-12
• Packaged Heat Pump with ReliaTel™ Controls, 12½-20 Tons Heaters .....	LPH-13

## Contents - Light Commercial

---

### Packaged Gas/Electric

- Convertible, 3-10 Tons Features .....LPG-1
- Convertible, 3-5 Tons, 17 SEER, R-410A (YHC-E).....LPG-2
- Convertible, 3-5 Tons, 15 SEER, R-410A (YHC) .....LPG-3
- Convertible, 3-5 Tons, 14 SEER, R-410A (YSC-G).....LPG-4
- Convertible, 3-5 Tons, 13 SEER, R-410A (YSC-G).....LPG-5
- Convertible, 3-5 Tons, 13 SEER, R-410A (YSC-E) .....LPG-6
- Convertible, 6-10 Tons, R-410A (YHC-F).....LPG-7
- Convertible, 6-10 Tons, R-410A (YSC) .....LPG-8
- Convertible, 3-10 Tons Model Digit Numbers.....LPG-9
- Convertible, 3-10 Tons Accessories.....LPG-11
- Convertible, 3-10 Tons Zone Sensors/Thermostats.....LPG-13
- Packaged Gas/Electric with ReliaTel™ Controls 12½-25 Tons,  
R-410A (YHD-F, YHH-F) .....LPG-14
- Packaged Gas/Electric with ReliaTel™ Controls 12½-25 Tons,  
R-410A (YSD-F, YSH-F).....LPG-16
- Packaged Gas/Electric with ReliaTel™ Controls 12½-25 Tons  
Model Digit Numbers .....LPG-18
- Packaged Gas/Electric with ReliaTel™ Controls 12½-25 Tons Accessories.....LPG-19
- Packaged Gas/Electric with ReliaTel™ Controls 12½-25 Tons  
Zone Sensors/Thermostats .....LPG-20
- Foundation™ Packaged Gas/Electric, 15-25 Tons, R-410A (GAC/GAD).....LPG-22
- Foundation™ Packaged Gas/Electric, 15-25 Tons, R-410A Accessories .....LPG-23

### Accessories/Information

- 3-25 Ton Packaged Units Roof Curb Compatibility Information ..... LAC/IN-1
- 6-20 Tons Split System ..... LAC/IN-2

# Model Nomenclature Residential

## Outdoor Units

1 2 3 4 5 6 7 8 9 10 11 12 13 14 15  
4 A 6 V 0 0 3 6 A 1 0 0 0 A A

Refrigerant Type  
2 = R-22  
4 = R-410A

A, T = American Standard

Product Type  
6, W = Split Heat Pump  
7, T = Split Cooling

Product Family  
V = Variable Speed M or B = Basic  
Z = Leadership – Two Stage A = Light Commercial  
X = Leadership  
R = Replacement/Retail

Family SEER  
3 = 13 6 = 16 0 = 20  
4 = 14 8 = 18  
5 = 15 9 = 19

Split System Connections 1-6 Tons  
0 = Brazed

Nominal Capacity in 1000s of BTUs

Major Design Modifications

Power Supply  
1 = 200-230/1/60 or 208-230/1/60  
3 = 200-230/3/60  
4 = 460/3/60

Secondary Function

Minor Design Modifications

Unit Parts Identifier

## Air Handler

1 2 3 4 5 6 7 8 9 10 11 12 13 14 15  
G A M 2 A 0 A 3 6 S 3 1 S A A

Brand  
T = American Standard  
G = Good (American Standard Branded)

Product Type  
A = Air Handler  
E = Air Handler

Convertability  
M = Multi-poise 4-way  
F = Upflow Front Return, 3-way  
T = 3-way

Product Tier  
2 = Good, Entry Level Feature Set  
3 = Good, Entry Level Feature Set  
4 = Better, Retail Replacement Mid Effy.  
5 = Better, Entry Level High Effy., Multi-Speed  
7 = Best, Retail Replacement High Effy., Variable-Speed  
8 = Best, Retail Ultimate High Effy., Variable-Speed  
G = Best, Geothermal

Major Design Change

No Descriptor  
0 = Air Handler / Coil

Size (Footprint)  
A = 17.5 x 21.5  
B = 21.0 x 21.5  
C = 23.5 x 21.5

Cooling Size: Air Handler or Coil  
0-9 = AH Coil - 1000 BTU's (18, 24, 30, 36, 42, 48, 60)

Airflow Type & Capability  
S = Standard Effy PSC, 1-5 - nom. Tonnage (cfm/ton)  
M = Mid Effy Multi-Speed, 1-5 - nom. Tonnage (cfm/ton)  
H = High Effy Variable, 1-5 - nom. Tonnage (cfm/ton)  
V = High Effy Variable, 1-5 - nom. Tonnage (cfm/ton)

Power Supply  
1 = 208-230/1/60

System Control Type  
S = Standard - 24 VAC  
C = CLII 13.8 VDC

Minor Design Change

Unit Parts Identifier

## Accessories

1 2 3 4 5 6 7 8 9 10 11  
A Y E C O N 0 0 1 A A

Denotes: Accessories

Accessories Type (Example: BAYCURB, AY, ASY)

ASCT = Anti-Cycle Timer	LOAM = Low Ambient Controls
BARM = Barometric Relief	LPKT = L.P. Kit
BASE = Subbase	LSDR = Low Static Drive
BRZQ = Coupling Kit Adaptors	NXKT = NOx Rod Accessory Kit
CCHT = Crankcase Heater	PANL = Panel
CLE = Coil Enclosures	PLNM = Plenum
CURB = Roof Curb	PLUS = Add-on Heat Pump
DMPR = Damper	REFLN = Refrigerant Lines
DNFLW = Downflow Conversion Kit	RLAY = Relay
ECON = Economizer	SENS = Sensor
ENTH = Enthalpy Control	SPEK = Single Power Entry Kit
FLTR = Filter	STAT = Thermostat
GARD = Coil Guard	TBKT = Thru Base Utility Kit
GRLE = Return Air Grill	TEST = Test Accessory
HALT = High Altitude Kit	TFMR = Transformer
HGBP = Hot Gas Bypass Control	TWIN = Twinning Kits
HSMT = High Static Motor	TXVA = Cooling — Bleed/Non Bleed Kits
HTRA = Electric Heater (Digit 7 Is Used To Differentiate The Products Accessory Is Used With)	TXVH = Heat Pump Non Bleed Kits
ISLT = Isolator	UTIL = Curb Ext. Kit
KSKT = Start Accessory Kit	VENT = Termination Kit
LEG = Snow Legs	WAR = Warranty
LIFT = Lifting Lug Kit	WATR = Hydronic Heat Coils
	WRKT = Wire Kit
	2STG = 2 Stage Gas

Major Design Change  
Numbers Are Sequentially Assigned Except For Electric Heaters.  
On Electric Heaters Digit 8 Is Used To Identify Voltage And Digit 9  
And 10 Are Used To Identify Capacity In KW's.

Minor Design Change  
Accessory To Unit Match-up (When Required)

Service Digit - Not Orderable

For complete equipment / combination selections, installation instructions and warranty information, please refer to Product Data/Ratings and/or Installers Guides and Limited Warranty Handbooks.



# Model Nomenclature Residential

## Air Handler

1 2 3 4 5 6 7 8 9 10 11 12 13 14 15  
4 F W C A 0 2 4 A 1 0 0 0 A A

- Refrigerant Type** \_\_\_\_\_  
4 = R-410A
- Model Type** \_\_\_\_\_  
FWC = Convertible  
FWH = Convertible with Constant Torque ECM Motor  
FWM = Stud Mount with Factory Installed Electric Heat  
FWD = Furr-Down Uncased with Factory Installed Electric Heat  
FWF = Furr-Down Cased with Factory Installed Electric Heat
- Insulation** \_\_\_\_\_  
A = Standard  
F = R4.2 Insulation
- Capacity** \_\_\_\_\_  
Nominal Capacity in 1000's (BTUH)
- Major Design Change** \_\_\_\_\_
- Power Supply** \_\_\_\_\_  
1 = Single Phase
- Electrical Connection** \_\_\_\_\_  
0 = Pig Tails  
D = Pull Disconnect
- Electric Heater** \_\_\_\_\_  
00 = No heater  
05 = 5 KW  
08 = 8 KW  
10 = 10 KW  
15 = 15 KW  
20 = 20 KW
- Minor Design Change** \_\_\_\_\_
- Service Digit - Not Orderable** \_\_\_\_\_

## Air Handler/ Electric Furnace Heaters

1 2 3 4 5 6 7 8 9 10 11 12 13 14  
B A Y H T R 1 4 1 5 B R K A

- Accessory** \_\_\_\_\_
- Heater** \_\_\_\_\_
- Power Supply** \_\_\_\_\_  
1 = Single Phase  
3 = Three Phase
- Series/Family** \_\_\_\_\_  
3 = 2/4TEH Models Only  
4 = 4TEC / Legacy  
5 = TEM Models Only
- Heater KW** \_\_\_\_\_
- Electrical Connection** \_\_\_\_\_  
000 = Pig Tails Only  
BRK = Circuit Breaker  
PDC = Pull Disconnect  
RBR = Recessed Breaker-TVF018, TVF024, 14" Deep only  
RPD = Recessed Pull Disconnect-TVF018, TVF024, 14" Deep only
- Minor Design Change** \_\_\_\_\_

## Air Handler - Residential

1 2 3 4 5 6 7 8 9 10 11 12 13 14 15  
T E M 4 A 0 B 3 6 S 3 1 S A A

- Brand** \_\_\_\_\_  
T = American Standard
- Product Type** \_\_\_\_\_  
E = Metal Cabinet  
M = Metal Over Hot Water Heater
- Convertability** \_\_\_\_\_  
M = Multi-poise 4-way
- Product Tier** \_\_\_\_\_  
4 = Entry Level Multi-Speed  
6 = Entry Level Variable Speed
- Major Design Change** \_\_\_\_\_
- No Descriptor** \_\_\_\_\_  
0 = Air Handler / Coil
- Size (Footprint) (W x D)** \_\_\_\_\_  
B = 21.0 x 21.1  
C = 23.5 x 21.1  
D = 26.0 x 21.1
- Cooling Size: Air Handler or Coil** \_\_\_\_\_  
0-9 = AH Coil - 1000 BTU's (18, 24, 30, 36, 42, 48, 60)
- Airflow Type & Capability** \_\_\_\_\_  
S = Standard Effy, 1-5 - nom. Tonnage (cfm/ton)  
M = Mid Effy Multi-Speed, 1-5 - nom. Tonnage (cfm/ton)  
H = High Effy Variable, 1-5 - nom. Tonnage (cfm/ton)  
V = High Effy Variable, 1-5 - nom. Tonnage (cfm/ton)
- Power Supply** \_\_\_\_\_  
1 = 208-230/1/60
- System Control Type** \_\_\_\_\_  
S = Standard - 24 VAC  
C = CLII 13.8 VDC
- Minor Design Change** \_\_\_\_\_
- Unit Parts Identifier** \_\_\_\_\_

For complete equipment / combination selections, installation instructions and warranty information, please refer to Product Data/Ratings and/or Installers Guides and Limited Warranty Handbooks.

# Model Nomenclature Residential

## Gas Furnaces

1 2 3 4 5 6 7 8 9 10 11 12 13 14 15  
A U D 1 B 0 8 0 A 9 H 3 1 A A

### Furnace Configuration

AU = Upflow/Horizontal  
AD = Downflow/Horizontal

### Type

E = 80% Induced Draft Standard  
D = 80% Induced Draft Premium  
C = 90% Condensing Standard  
X = 90% Condensing Premium  
H = 95% Condensing Premium

### Number of Heating Stages

1 = Single Stage  
2 = Two Stage  
3 = Three Stage  
M = Modulating

### Cabinet Width

A = 14.5" Cabinet Width  
B = 17.5" Cabinet Width  
C = 21.0" Cabinet Width  
D = 24.5" Cabinet Width

### Heating Input in 1000's (BTUH)

080 = 80,000 BTUH

### Major Design Change

### Voltage

9 = 115 Volts / 60 Hertz / Natural Gas  
A = 115 Volts / 50 Hertz / Natural Gas  
C = 115 Volts / Natural Gas with Communicating System Control  
F = 115 Volts / Natural Gas with Integrated Electronic Filter  
D = 115 Volts / Natural Gas with Communicating System Control and Integrated Electronic Filter

### Air Capacity for Cooling

Standard PSC	Variable Speed	High Efficiency
24 = 2 Tons	V3 = 3 Tons	H3 = 3 Tons
36 = 3 Tons	V4 = 4 Tons	H4 = 4 Tons
42 = 3.5 Tons	V5 = 5 Tons	H5 = 5 Tons
45 = 4 Tons		
48 = 4 Tons		
54 = 5 Tons		
60 = 5 Tons		
72 = 6 Tons		

### Draft Inducer Speeds

1 = Single Speed  
2 = Two Speed  
V = Variable Speed

### Minor Design Change

### Service Digit - Not Orderable

## Gas Furnaces

1 2 3 4 5 6 7 8 9 10 11 12  
A U Y 0 8 0 R 9 V 3 V 0

### Furnace Configuration

AU = Upflow/Horizontal  
AD = Downflow/Horizontal

### Type

C = Condensing  
D = Induced Draft  
X = Direct Vent Condensing

### Heating Input in 1000's (BTUH)

080 = 80,000 BTUH

### Major Design Change

C = Single Stage R = Two Stage  
All other = Standard System

### Power Supply and Fuel

115 Volt Natural Gas

### Airflow Capacity for Cooling

Example: 36 = 3 Tons  
400 CFM/Ton  
400 x 3 Tons = 1200 CFM  
V3 = 1 1/2 – 3 Tons, Variable Speed Motor (ICM)  
V4 = 2 – 4 Tons, Variable Speed Motor (ICM)  
V5 = 3 – 5 Tons, Variable Speed Motor (ICM)

### Minor Design Change

V = Variable Speed Inducer

### Service Digit - Not Orderable

# Model Nomenclature Residential

## Oil Furnaces (Legacy)

1 2 3 4 5 6 7 8 9 10 11 12 13 14 15  
T H V 1 M 0 8 7 A 9 3 6 S A A

### Furnace Configuration

HV = High Boy Vertical Flue  
LF = Low Boy Front Flue (vertical)  
LR = Low Boy Rear Flue  
DF = Downflow/Horizontal Front Flue

### Heating Stages

### Cabinet Width

M = 22 1/4"

### Heating Output in 1000's (BTUH)

087 = 87,000 BTUH

### Major Design Change

### Power Supply

1 = 115 v/1 ph/60hz

### Nominal Capacity

Standard Variable Speed  
36 = 3 Tons V3 = 3 Tons  
48 = 4 Tons V4 = 4 Tons

### Efficiency

S = 80% + AFUE

### Minor Design Change

### Service Digit - Not Roderable

## Heat Pump/ Cooling Coils

1 2 3 4 5 6 7 8 9 10 11 12 13 14 15  
4 T X C B 0 3 6 A C 3 H C A A

### Refrigerant Type

4 = R-410A

### Series

T = Premium (Cooling and HP)  
N = Premium (Cooling and HP)  
P = Premium High Efficiency - Dedicated position (Cooling and HP)  
C = Standard (Cooling Only)  
F = Entry Level (Cooling Only)  
G = Entry Level (Cooling and HP)

### Coil Design

X = Direct Expansion Evaporator Coil

### Coil Feature

C = Cased A Coil  
A = Uncased A Coil  
F = Cased Horizontal Flat Coil

### Coil Width (Cased/Uncased)

A = 14.5" / 13.3"  
B = 17.5" / 16.3"  
C = 21.0" / 19.8"  
D = 24.5" / 23.3"  
H = 10.5"

### Refrigerant Line Coupling /

### Airflow Configuration

0 = Brazed  
U = Upflow only, convertible to Horizontal Left  
D = Downflow only, convertible to Horizontal Right

### Nominal Capacity in 1000's (BTUH) /

### Model Number Distinguisher

### Major Design Change

### Efficiency

C = Standard  
S = High Efficiency (derived from 10 SEER products)  
Z = High Efficiency (TXV modulates to 50%)

### Refrigerant Control

3 = TXV - Non-Bleed  
6 = FCCV (Flow Control/Check Valve)

### Coil Circuitry

H = Heat Pump  
C = Cooling

### Airflow Configuration

A = Upflow  
U = Upflow /Downflow  
D = Downflow  
R = Downflow / Horizontal Right  
H = Horizontal Left/Right  
C = Convertible - Upflow, Downflow, Left or Right

### Minor Design Change

### Service Digit - Not Orderable

# Model Nomenclature Residential

## American Standard AccuClean™ Whole Home Air Cleaner

1 2 3 4 5 6 7 8 9 10 11 12 13 14 15  
A F D 1 4 5 A L F R 0 0 0 A A

Brand \_\_\_\_\_  
 Filtration \_\_\_\_\_  
 ifD \_\_\_\_\_  
 Size  
 Furnace Upflow      Furnace Downflow      Air Handler  
 145 = 14.5"      14D = 14.5"      215 = 21.5"  
 175 = 17.5"      17D = 17.5"      235 = 23.5"  
 210 = 21.0"      21D = 21.0"      260 = 26.0"  
 245 = 24.5"      24D = 24.5"  
 Major Design Series \_\_\_\_\_  
 Power Supply  
 L = Low Voltage  
 Application  
 AH000 = Air Handler  
 FR000 = Furnace  
 Minor Design \_\_\_\_\_  
 Service Sequence Not Orderable \_\_\_\_\_

## Perfect Fit™ Air Cleaner

1 2 3 4 5 6 7 8 9 10 11 12  
T F M 175 B 0 FR 1 1

Filter \_\_\_\_\_  
 Filter Type \_\_\_\_\_  
 M = Media, 5 Inch, 1 Inch  
 Product Dimension  
 145 = 14.5 Inch Furnace Width    215 = 21.5 Inch Air Handler Width  
 175 = 17.5 Inch Furnace Width    235 = 23.5 Inch Air Handler Width  
 210 = 21.0 Inch Furnace Width    260 = 26.0 Inch Air Handler Width  
 245 = 24.5 Inch Furnace Width  
 Product Development Sequence  
 B = 5" Expandable Media  
 Voltage  
 1 = 240V    9 = 140V  
 Product Description  
 AH = Air Handler  
 FR = Furnace  
 Minor Design Change \_\_\_\_\_  
 Service Digit - Not Orderable \_\_\_\_\_

## TXV Kits

1 2 3 4 5 6 7 8 9 10 11 12 13 14 15  
2 A Y T X V H 3 A 2 5 3 1 A A

Refrigerant  
 4 = R-410A  
 2 = R-22  
 Accessory  
 Accessory Type  
 TXV Kit  
 Compatibility  
 Cooling & Heat Pump Compatible  
 Flow Control  
 3 = TXV - Non Bleed  
 Major Design Change  
 B = Internally Mounted (Mechanical Fittings)  
 C = Internally Mounted (Mechanical Fittings)  
 D = Internally Mounted (Mechanical Fittings)  
 Minimum Nominal Capacity in 000's BTU's \_\_\_\_\_  
 Maximum Nominal Capacity in 000's BTU's \_\_\_\_\_  
 Minor Design Change \_\_\_\_\_  
 Service Digit - Not Orderable \_\_\_\_\_

## Perfect Fit™ Filter Accessories

1 23 45 67 89 10 11 12  
B AY FT FR EX M 2 A

Business Unit \_\_\_\_\_  
 Accessory \_\_\_\_\_  
 Filter \_\_\_\_\_  
 Product Type  
 AH = Air Handler  
 FR = Furnace  
 Size  
 EX = Expandable  
 Type  
 M = Media, 5 Inch  
 Quantity  
 1 = 1    2 = 2    4 = 4    D = Dozen  
 Minor Design Change \_\_\_\_\_

# Model Nomenclature Residential

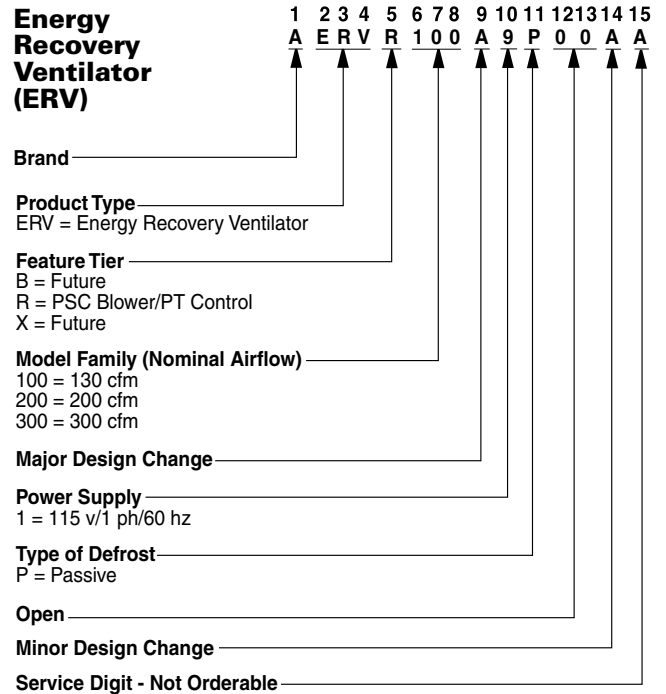
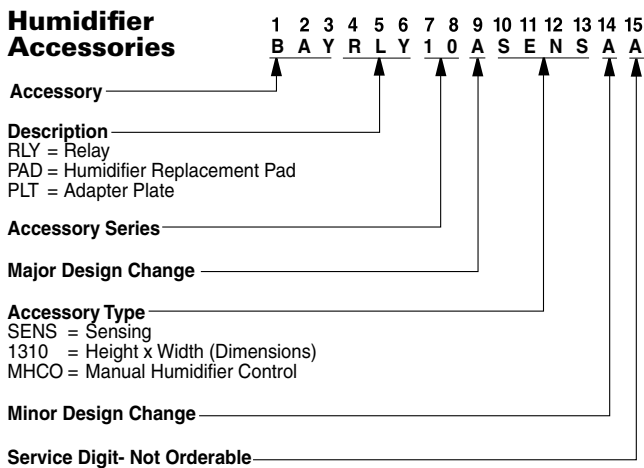
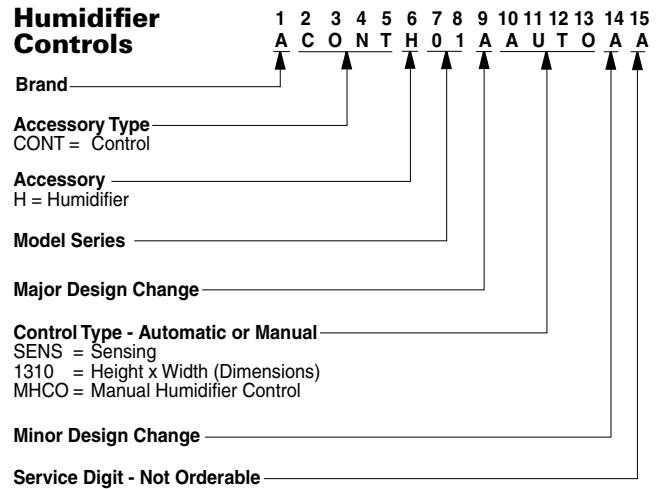
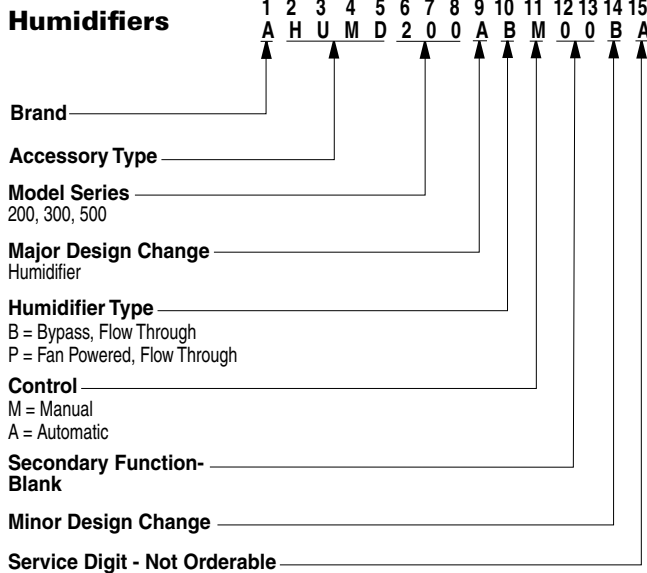

# Model Nomenclature Residential

**Packaged Units**

1 2 3 4 5 6 7 8 9 10 11 12 13 14 15  
4 Y C X 3 0 4 2 A 3 0 8 0 A A

**Refrigerant** —————  
4 = R-410A

**Type** —————  
YC = Gas Electric  
WC = Heat Pump  
DC = Dual Fuel  
TC = Air Conditioner

**Model Tier** —————  
C = Entry Level  
X = Upgrade  
Y = Premium  
Z = Leadership - (2-Stage)

**Efficiency Tier** —————  
3 = 13 SEER  
4 = 14 SEER  
6 = 16 SEER

**Capacity in 1000's (BTUH)** —————  
018 042  
024 048  
030 060  
036

**Major Design Change** —————

**Voltage & Phase** —————  
1 = 230V 1 Phase  
3 = 230V 3 Phase  
4 = 460V 3 Phase

**Gas Heat Input (MBTU/H)** —————  
000 (AC or HP) 075  
040 096  
064 120

**Minor Design Change** —————

**Service Digit - Not Orderable** —————

**Packaged Units**

1 2 3 4 5 6 7 8 9 10 11 12  
Y C X 0 3 6 G 1 M 0 A 0

**Product Type** —————  
TC = Cooling, Electric Heat  
WC = Heat Pump Packaged  
YC = Gas Electric  
DC = Heat Pump with Gas Heat

**Airflow Configuration** —————  
D = Downflow Y = Super High Efficiency  
H, K = Horizontal Z = Ultra High Efficiency  
C = Convertible  
X = High Efficiency

**Cooling Capacity in 1000's (BTUH)** —————  
018 = 1 1/2 Tons 060 = 5 Tons  
024 = 2 Tons 150 = 12 1/2 Tons  
030 = 2 1/2 Tons 180 = 15 Tons  
036 = 3 Tons 210 = 17 1/2 Tons  
042 = 3 1/2 Tons 240 = 20 Tons  
048 = 4 Tons 300 = 25 Tons

**Commercial High Efficiency Units**  
151 = 12 1/2 Tons  
181 = 15 Tons  
211 = 17 1/2 Tons  
241 = 20 Tons  
301 = 25 Tons

**Major Design Change** —————  
F = Impack - Side by Side - Ft. Smith Only  
B = Over/Under - Ft. Smith Only  
G = Impack Plus - Side by Side - Ft. Smith Only

**Electrical Characteristics** —————  
1 = 208-230/1/60  
3 = 208-230/3/60  
4 = 460/3/60

**Secondary Capacity And/Or Factory-Installed Options** —————  
00 = No Heat, No Options  
LO = Low Heating Capacity  
MO = Medium Heating Capacity  
HO = High Heating Capacity

**Minor Design Change** —————

**Service Digit - Not Orderable** —————

# Model Nomenclature Residential

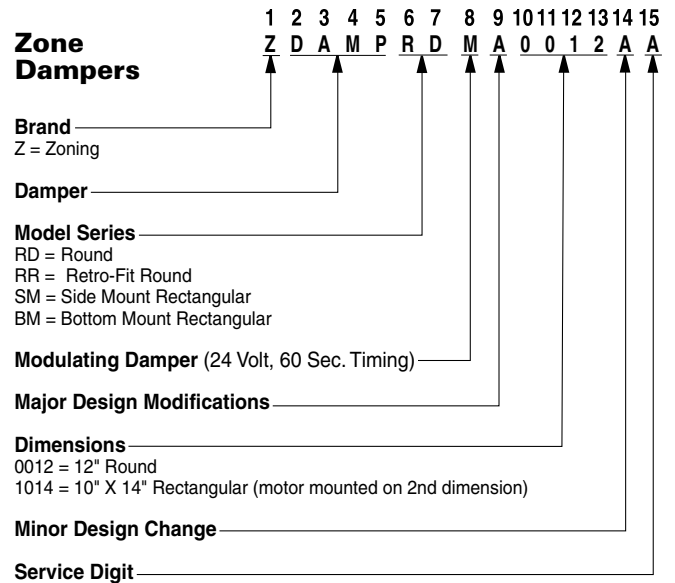
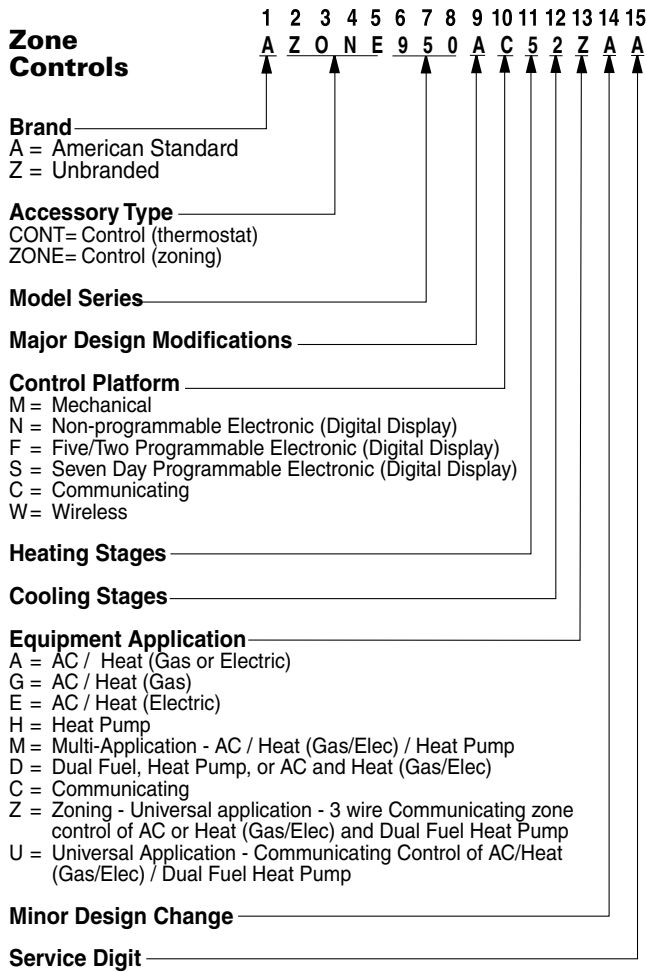

# Model Nomenclature Residential

## Ductless Indoor Unit

1 2 3 4 5-6 7-8 9 10 11 12 13 14 15  
4 M X X 65 12 A 1 0 N 0 B A

**Refrigerant**  
4 = R-410A

**Unit Type**  
M = Indoor Unit  
U = Pro Series

**Functional Type**  
X = Heat Pump Inverter  
Y = Cooling Only Inverter

**Configuration Indoor Unit**  
W = High Wall Unit  
D = Ceiling Concealed Unit  
C = Cassette Unit  
F = Floor Console Unit  
X = Convertible (Floor/Ceiling) Mount  
L = Cassette Panel Cover

**Efficiency Tier**  
16 = 16 SEER  
65 = 16 SEER  
85 = 18 SEER  
20 = up to 20 SEER Pro Series  
22 = up to 22 SEER  
27 = up to 27 SEER

**Nominal Capacity (Btu/h x 1,000)**  
09 = 9,000 Btu/h    24 = 24,000 Btu/h    48 = 48,000 Btu/h  
12 = 12,000 Btu/h    30 = 30,000 Btu/h  
18 = 18,000 Btu/h    36 = 36,000 Btu/h  
21 = 21,000 Btu/h    42 = 42,000 Btu/h

**Major Development Sequence**  
A, B, C, etc. = Major Development Sequence

**Electric Power Supply Characteristics**  
1 = 208-230/60/1  
L = 115/60/1

**Reserved for Future Use**  
0 = Not Currently Used

**Regional Markets Served (1:1 Systems)**  
N = North America Market

**Reserved for Future Use**  
0 = Not Currently Used

**Minor Design Sequence**  
A, B, C, etc. = Minor Design Sequence

**Service Digit**  
A, B, C, etc. = Service Digit Sequence

## Ductless Outdoor Unit

1 2 3 4 5-6 7-8 9 10 11 12 13 14 15  
4 T X K 65 12 A 1 0 N 0 B A

**Refrigerant**  
4 = R-410A

**Brand**  
T = Outdoor Unit

**Functional Type**  
X = Heat Pump Inverter  
Y = Cooling Only Inverter

**Configuration Outdoor Unit**  
K = Single Refrigerant Circuit  
M = Multiple Refrigerant Circuits  
U = Pro Series

**Efficiency Tier**  
16 = 16 SEER  
65 = 16 SEER  
85 = 18 SEER  
20 = up to 20 SEER Pro Series  
22 = up to 22 SEER  
27 = up to 27 SEER

**Nominal Capacity (Btu/h x 1,000)**  
09 = 9,000 Btu/h    24 = 24,000 Btu/h    48 = 48,000 Btu/h  
12 = 12,000 Btu/h    30 = 30,000 Btu/h  
18 = 18,000 Btu/h    36 = 36,000 Btu/h  
21 = 21,000 Btu/h    42 = 42,000 Btu/h

**Major Development Sequence**  
A, B, C, etc. = Major Development Sequence

**Electric Power Supply Characteristics**  
1 = 208-230/60/1  
L = 115/60/1

**Reserved for Future Use**  
0 = Not Currently Used

**Regional Markets Served (1:1 Systems)**  
N = North America Market  
**or Number of Refrigerant Ports (Multi-Split Systems)**  
2 = Two Port System  
3 = Three Port System  
4 = Four Port System  
5 = Five Port System

**Reserved for Future Use**  
0 = Not Currently Used

**Minor Design Sequence**  
A, B, C, etc. = Minor Design Sequence

**Service Digit**  
A, B, C, etc. = Service Digit Sequence



# Model Nomenclature Light Commercial

## Commercial Condensing Units Cooling and Heat Pump

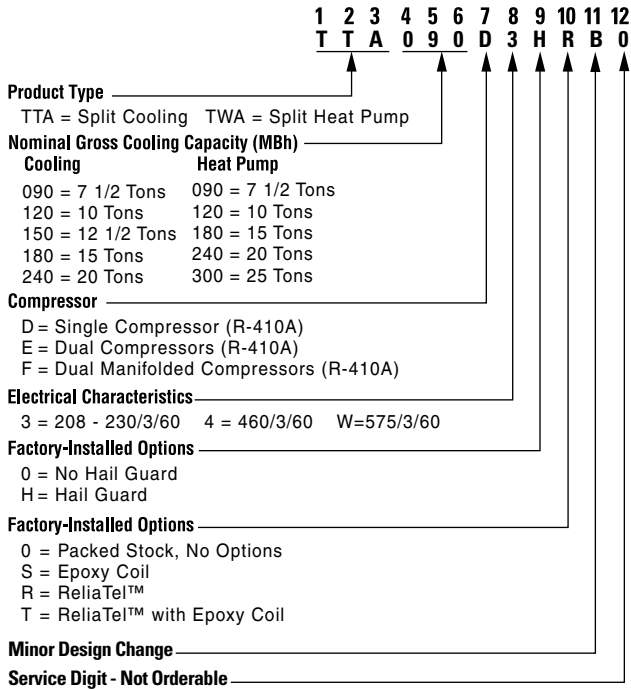

## Air Handler - Commercial

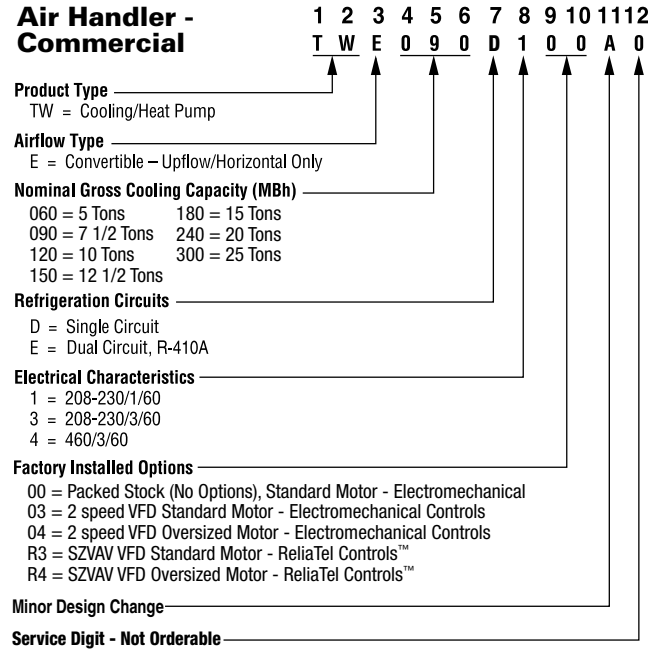

# Model Nomenclature Light Commercial

## Packaged Units

**Y H C 0 3 7 E 3 R Z B \* \* C 0 0 0 A 1 0 0 0 0 A 1**  
**1 2 3 4 5 6 7 8 9 10 11 12 13 14 15 16 17 18 19 20 21 22 23 24 25**

### Digit 1 – Unit Type

T = DX Cooling  
Y = DX Cooling, Gas Heat

### Digit 2 – Efficiency

H = High Efficiency

### Digit 3 – Airflow

C = Convertible

### Digit 4,5,6 – Nominal Gross Cooling Capacity (MBh)

037 = 3 Tons  
047 = 4 Tons  
067 = 5 Tons

### Digit 7 – Major Design Sequence

E = R-410A Refrigerant

### Digit 8 – Voltage Selection

3 = 208-230/60/3  
4 = 460/60/3

### Digit 9 – Unit Controls

R = ReliaTel™ Microprocessor

### Digit 10 – Heating Capacity

0 = No Electric Heat      G = 18 kW (1&3 phase)  
B = 6 kW (3 phase)      J = 23 kW (3 phase)  
E = 12 kW (3 phase)  
L = Low Heat  
M = Medium Heat  
H = High Heat  
X = Low Heat, Stainless Steel Heat Exchanger  
Y = Medium Heat, Stainless Steel Heat Exchanger  
Z = High Heat, Stainless Steel Heat Exchanger

### Digit 11 – Minor Design Sequence

A = First Sequence<sup>①</sup>

### Digit 12,13 – Service Sequence

\*\*Factory Assigned

### Digit 14 – Fresh Air Selection

0 = No Fresh Air  
A = Manual Outside Air Damper 0-50%<sup>②</sup>  
B = Motorized Outside Air Damper 0-50%  
C = Economizer, Dry Bulb 0-100% without Barometric Relief<sup>③</sup>  
D = Economizer, Dry Bulb 0-100% with Barometric Relief<sup>③</sup>  
E = Economizer, Reference Enthalpy 0-100% without Barometric Relief<sup>③</sup>  
F = Economizer, Reference Enthalpy 0-100% with Barometric Relief<sup>③</sup>  
G = Economizer, Comparative Enthalpy 0-100% without Barometric Relief<sup>③</sup>  
H = Economizer, Comparative Enthalpy 0-100% with Barometric Relief<sup>③</sup>  
K = Low Leak Economizer, Dry Bulb with Barometric Relief  
M = Low Leak Economizer, Comparative Enthalpy with Barometric Relief  
P = Low Leak Economizer, Reference Enthalpy with Barometric Relief

① Standard on all variable stage units.

② Manual outside air damper will ship factory supplied within the unit, but must be field installed.

③ High pressure control is standard on all units.

④ Constant CFM direct drive is standard for 3-5 Ton variable stage units.

### Digit 15 = 0, 6

3 Phase (3-5 ton) = High Efficiency Constant CFM

⑤ Economizer with Barometric Relief is for downflow configured units only. Order Economizer without Barometric Relief for horizontal configuration. Barometric Relief for horizontal configured units must be ordered as field installed accessory.

### Digit 15 – Supply Fan/Drive Type/Motor

0 = Standard Drive<sup>④</sup>  
1 = Oversized Motor  
2 = Optional Belt Drive Motor<sup>⑤</sup>  
6 = Single Zone VAV<sup>⑥</sup>  
7 = Multi-Speed Indoor Fan<sup>⑦</sup>  
E = VAV Supply Air Temperature Control Standard Motor<sup>⑧</sup>

### Digit 16 – Hinged Service Access/Filters

0 = Standard Panels/Standard Filters  
A = Hinged Access Panels/Standard Filters  
B = Standard Panels/2" MERV 7 Filters  
C = Hinged Access Panels/2" MERV 7 Filters  
D = Standard Panels/2" MERV 13 Filters  
E = Hinged Access Panels/2" MERV 13 Filters

### Digit 17 – Condenser Coil Protection

0 = Standard Coil  
1 = Standard Coil with Hail Guard  
2 = Black Epoxy Pre-Coated Condenser Coil  
3 = Black Epoxy Pre-Coated Condenser Coil with Hail Guard  
4 = Complete Coat™ Condenser Coil  
5 = Complete Coat™ Condenser Coil with Hail Guard

### Digit 18 – Through the Base Provisions

**Note:** *Applicable to Digit 1, T or Y models*

0 = No Through the Base Provisions  
A = Through the Base Electric<sup>⑨</sup>  
B = Through the Base Gas Piping<sup>⑩</sup>  
C = Through the Base Electric and Gas Piping<sup>⑩</sup>

### Digit 19 – Disconnect/Circuit Breaker (three - phase only)

0 = No Disconnect/No Circuit Breaker  
1 = Unit Mounted Non-Fused Disconnect<sup>⑪</sup>  
2 = Unit Mounted Circuit Breaker<sup>⑪</sup>

### Digit 20 – Convenience Outlet

0 = No Convenience Outlet  
A = Unpowered Convenience Outlet  
B = Powered Convenience Outlet (three-phase only)<sup>⑫</sup>

### Digit 21 – Communications Options

0 = No Communications Interface  
3 = Novar 2024 Controls  
4 = Novar 3051 Controls without Zone Sensor  
5 = Novar 3051 Controls Interface with DCV  
6 = BACnet™ Communications Interface

### Digit 22 – Refrigeration System Option

0 = Standard Refrigeration System<sup>⑬</sup>  
B = Dehumidification Option<sup>⑭</sup>

④ Through the base electric required when ordering disconnect/circuit breaker options.

⑦ Requires use of Disconnect or Circuit Breaker.

### Not Available

High Efficiency  
3-5 ton w/Standard Indoor Motor w/460V

① Standard metering devices are TXVs.

③ The return air smoke detector may not fit up or work properly on the Precedent units when used in conjunction with 3rd party accessories such as bolt on heat wheels, economizers and power exhaust. Do not order the return air smoke detectors when using this type of accessory.

⑧ Return Air Smoke Detector cannot be ordered with Novar Controls.

### Digit 23 – Refrigeration Controls

**Note:** *Applicable to Digit 7 = E*

0 = No Refrigeration Control<sup>⑮</sup>  
1 = Frostat  
2 = Crankcase Heater<sup>⑯</sup>  
3 = Frostat and Crankcase Heater<sup>⑯</sup>

### Digit 24 – Smoke Detector<sup>⑰</sup>

0 = No Smoke Detector  
A = Return Air Smoke Detector<sup>⑱</sup>  
B = Supply Air Smoke Detector  
C = Supply and Return Air Smoke Detectors<sup>⑱</sup>  
D = Plenum Smoke Detector

### Digit 25 – Monitoring Controls

0 = No Monitoring Control<sup>⑲</sup>  
1 = Clogged Filter Switch<sup>⑲</sup>  
2 = Fan Failure Switch<sup>⑲</sup>  
3 = Discharge Air Sensing Tube<sup>⑲</sup>  
4 = Clogged Filter Switch and Fan Fail Switch<sup>⑲</sup>  
5 = Clogged Filter Switch and Discharge Air Sensing Tube<sup>⑲</sup>  
6 = Fan Fail Switch and Discharge Air Sensing Tube<sup>⑲</sup>  
7 = Clogged Filter and Fan Fail Switches and Discharge Air Sensing Tube<sup>⑲</sup>  
8 = Novar Return Air Sensor<sup>⑲</sup>  
9 = Novar 3051 Zone Sensor<sup>⑲</sup>  
A = Condensate Drain Pan Overflow Switch  
B = Clogged Filter Switch<sup>⑲</sup> and Condensate Drain Pan Overflow Switch  
C = Fan Failure Switch<sup>⑲</sup> and Condensate Drain Pan Overflow Switch  
D = Discharge Air Sensing<sup>⑲</sup> and Condensate Drain Pan Overflow Switch  
E = Clogged Filter Switch<sup>⑲</sup>, Fan Failure Switch<sup>⑲</sup> and Condensate Drain Pan Overflow Switch  
F = Clogged Filter Switch<sup>⑲</sup>, Discharge Air Sensing Tuber and Condensate Drain Pan Overflow Switch  
G = Fan Failure Switch, Discharge Air Sensing Tuber and Condensate Drain Pan Overflow Switch  
H = Clogged Filter Switch<sup>⑲</sup>, Fan Failure Switch<sup>⑲</sup>, Discharge Air Sensing<sup>⑲</sup> and Condensate Drain Pan Overflow Switch

### Digit 26 – System Monitoring Controls

0 = No Monitoring Controls  
A = Demand Control Ventilation (CO<sub>2</sub>)<sup>⑳</sup>  
B = Fault Detection and Diagnostics (FDD)  
C = Fault Detection and Diagnostics (FDD) with Demand Control Ventilation

### Digit 27 – Unit Hardware Enhancements

0 = No Enhancements  
1 = Stainless Steel Drain Pan

### Digit 31 – Advanced Unit Controls

0 = Stainless Steel Drain Pan  
1 = Human Interface

⑮ These options are standard when ordering Novar Controls.

⑯ This option is used when ordering Novar Controls.

⑰ Includes gas piping and shutoff (field assembly required).

⑱ Not available with high temperature duct sensor accessory.

⑲ Novar Sensor utilized with Digit 21 = (4) Novar 3051 Controls without Zone Sensor.

⑳ Available for T/Y 3,4,5 ton high efficiency models.

㉑ Requires selection of 2" Pleated Filters (option B or C) for Digit 16.

For complete equipment / combination selections, installation instructions and warranty information, please refer to Product Data/Ratings and/or Installers Guides and Limited Warranty Handbooks.

# Model Nomenclature Light Commercial

**G A C 1 8 0 A 3 E Z A 0 0**  
**1 2 3 4 5 6 7 8 9 10 11 12 13**

## Digit 1 – Unit Type

E = Packaged Cooling, Electric Heat  
G = Packaged Cooling, Electric Heat

## Digit 2 – Efficiency

A = ASHRAE 90.1 - 2010

## Digit 3 – Airflow Configuration

C = Convertible  
D = Downflow Only<sup>④</sup>

## Digit 4, 5, 6 – Nominal Gross Cooling Capacity (MBh)

180 = 15 Tons  
210 = 17½ Tons  
240 = 20 Tons  
300 = 25 Tons

## Digit 7 – Major Design Sequence

A

## Digit 8 – Voltage Selection

3 = 208-230/60/3  
4 = 460/60/3  
K = 380/60/3  
W = 575/60/3

## Digit 9 – Unit Controls

E = Electromechanical

## Digit 10 – Heating Capacity

**Note:** (Applicable to Digit 1 E models only)

0 = No Heat  
G = 18 kW Electric Heat  
N = 36 kW Electric Heat  
P = 54 kW Electric Heat  
R = 72 kW Electric Heat

**Note:** (Applicable to Digit 1 G models only)

H = Gas Heat - High<sup>④</sup>  
L = Gas Heat - Low  
M = Gas Heat - Medium  
X = Gas Heat - SS Ht Ex - Low  
W = Gas Heat - SS Ht Ex - Medium  
Z = Gas Heat - SS Ht Ex - High<sup>④</sup>

## Digit 11 – Minor Design Sequence

## Digit 12-13 – Service Sequence

0 = None

## Digit 14 – Fresh Air Selection

0 = No Fresh Air  
A = Manual Outside Air Damper 0-50%  
B = Motorized Outside Air Damper 0-50%  
C = Economizer, Dry Bulb 0-100% without Barometric Relief  
D = Economizer, Dry Bulb 0-100% with Barometric Relief<sup>①</sup>  
E = Economizer, Reference Enthalpy 0-100% without Barometric Relief  
F = Economizer, Reference Enthalpy 0-100% with Barometric Relief<sup>①</sup>  
G = Economizer, Comparative Enthalpy 0-100% without Barometric Relief  
H = Economizer, Comparative Enthalpy 0-100% with Barometric Relief<sup>①</sup>

## Digit 15 – Supply Fan/Drive Type/Motor

0 = Standard Motor  
1 = Oversized Motor  
7 = Multi-Speed Standard Motor  
9 = Multi-Speed Oversized Motor

## Digit 16 – Not Used

## Digit 17 – Condenser Coil Protection

0 = Standard Coil  
4 = CompleteCoat™ Condenser Coil

## Digit 18 – Through The Base Provisions

**Note:** (Applicable to Digit 1, E models)  
0 = No Through The Base Provisions  
A = Through The Base Electric

**Note:** (Applicable to Digit 1, G models only)

0 = No Through The Base Provisions  
A = Through The Base Electric  
B = Through The Base Gas<sup>①</sup>  
C = Through The Base Electric/Gas

## Digit 19 – Disconnect Switch

0 = No Disconnect/circuit break  
1 = Unit Mounted Non-Fused Disconnect Switch<sup>②</sup>

## Digit 20 – Not Used

## Digit 21 – Not Used

## Digit 22 – Not Used

## Digit 23 – Not Used

## Digit 24 – Not Used

## Digit 25 – System Monitoring Controls

0 = No Monitoring Controls  
A = Condensate Drain Pan Overflow Switch

- ① Some field set up required.  
② Must be ordered with Through-the-Base Electrical option.  
③ All Factory Installed Options are Built-to-Order. Check order services for estimated production cycle.  
④ High heat is available on dowflow units only.

# Conventional 24 Volt Connected Controls

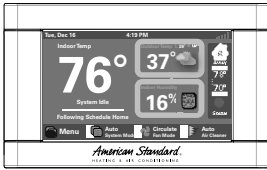

**GOLD 824  
ACONT824AS52DA**



### ACONT824AS52DA

- NEXIA™ Z-Wave Bridge Inside
- Connect over 200 Z-Wave devices
- WiFi (802.11 b/g/n) or Ethernet connection
- Control from a smartphone, tablet, or computer<sup>1,2</sup>
- 4.3" diagonal HD color touchscreen
- Compatible with non-communicating conventional 24 Volt systems
- Cooling, heating, heat pump, and dual fuel
- 7 Day programmable with up to six schedules per day
- Five day weather forecast, weather radar, and weather alerts<sup>1</sup>
- Indoor relative humidity display
- Enhanced dehumidification
- 2 Auxiliary dry contacts
- Control 2 of the following: Whole house humidifier, dehumidifier, or ventilation system
- Test modes and alert diagnostics
- Nexia Diagnostics
- Upgradeable software
- Silver/Gray color
- Limited Warranty: 5 yr. base/10 yr. registered

### Application:

HVAC system compatibility:

- Conventional gas/electric, heat pump, and dual fuel systems
- Conventional boiler systems (forced air only)
- Conventional HVAC systems:
  - 2 Heat / 2 cool
- Heat Pump systems: Up to 5 stages heat / 2 stages cool (2 compressor heat - 3 auxiliary heat / 2 cooling)
- Heat Pump switchover valve: Selectable "with cool or with heat"
- Remote Indoor Sensor (optional): ZZSENSAL0400AA
- Remote Outdoor Sensor (optional): BAYSEN01ATEMPA
- PWM Circuit (BK terminal): controls indoor unit variable speed blowers
- Wall Cover Plate BAYCOVER800A

### Dimensions:

- Product: 5.43"w x 3.39"h x 1.30"d
- Display: 4.15"w x 2.65"h

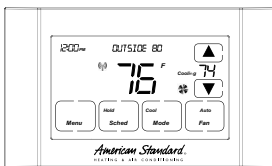

**SILVER 624  
ACONT624AS42DA**



### ACONT624AS42DA

- NEXIA™ Home Intelligence compatible
- Z-wave comfort control
- Control from a smartphone, tablet, or computer<sup>1,2,3</sup>
- 4.3" diagonal black and white touchscreen
- Compatible with conventional 24 volt HVAC, heat pump, dual fuel, and conventional boiler systems (baseboard and radiator)
- 7 Day programmable with up to 4 schedules per day
- Humidity sensor and RH display
- Remote temperature sensor connections (1 indoor/1 outdoor)
- Auxiliary & compressor heat lockouts
- Auxiliary dry contact
- Enhanced dehumidification (cooling)
- Adjustable variable speed fan settings (PWM)
- Energy Savings Mode (ESM)
- Screen lock and guest lock
- Service test modes
- Upgradeable software
- Silver/Gray color
- Limited Warranty: 1 yr. base/5 yr. registered

### Application:

HVAC system compatibility:

- Up to 4 Stages Heat/2 Stages Cool
- Conventional gas/electric, heat pump, and dual fuel systems
- Conventional boiler systems (baseboard & radiators)
- Remote Indoor Sensor (optional): ZZSENSAL0400AA
- Remote Outdoor Sensor (optional): BAYSEN01ATEMPA
- Wall Cover Plate BAYCOVER800A
- Use with Nexia Bridge for Nexia™ Home Intelligence compatibility<sup>1,2</sup>

### Dimensions:

- Product: 5.9"w x 3.47"h x .95"d
- Display: 3.8"w x 2.3"h

<sup>1</sup> Requires high speed router, internet service, and connection to Nexia™ Home Intelligence.

<sup>2</sup> Nexia Remote Climate Access is included with the purchase of a Connected Control. Adding accessories to your Nexia system requires a monthly subscription for remote access via most web-enabled smartphone and computers.

<sup>3</sup> Requires Nexia Bridge

# AccuLink™ Communicating Connected Controls



**PLATINUM 950  
AZONE950AC52ZA**



## AZONE950AC52ZA

- NEXIA™ Home Intelligence compatible
- WiFi (802.11 b/g/n)
- Control from a smartphone, tablet, or computer <sup>1,2,3</sup>
- 7" diagonal HD color touchscreen
- Compatible with AccuLink™ II communicating systems (variable speed and two stage)
- Compatible with conventional 24 Volt HVAC, heating, heat pump, and dual fuel systems when used with accessory relay panel model BAY24VRPAC52DB
- 7 Day programmable with up to 6 schedules per day
- Five day weather forecast, weather radar, and weather alerts <sup>1</sup>
- Indoor relative humidity display
- Control up to 3 accessory devices with relay panel model BAY24VRPAC52DB
- Whole house humidifier, dehumidifier, or ventilation system
- Test modes and diagnostic screens
- Nexia Diagnostics
- Upgradeable software
- Silver/Gray color
- Limited Warranty: 5 yr. base/10 yr. registered

## Application:

HVAC system compatibility:

- AccuLink™ II communicating systems (variable speed and two stage)
- Conventional gas/electric, heat pump, dual fuel systems, or boiler systems (forced air only) with use of relay panel model BAY24VRPAC52DB. Relay panel controls up to 5 stages heat, 2 stages cool, remote indoor and outdoor connections, humidifier, dehumidifier, and ventilation system.

## Dimensions:

- Product: 7.3"w x 4.3"h x 1.2"d
- Display: 6.1"w x 3.6"h

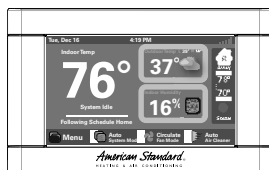

**PLATINUM 850  
ACONT850AC52UA**



## ACONT850AC52UA

- NEXIA™ Z-Wave Bridge Inside
- Connect over Z-Wave devices
- WiFi (802.11 b/g/n) or Ethernet connection
- Control from a smartphone, tablet, or computer <sup>1,2</sup>
- 4.3" diagonal HD color touchscreen
- Compatible with AccuLink™ II communicating systems (variable speed and two stage)
- Compatible with conventional 24 Volt HVAC, heating, heat pump, and dual fuel systems when used with accessory relay panel model BAY24VRPAC52DB
- 7 Day programmable with up to six schedules per day
- Five day weather forecast, weather radar, and weather alerts <sup>1</sup>
- Indoor relative humidity display
- Test modes and alert diagnostics
- Nexia Diagnostics
- Upgradeable software
- Silver/Gray color
- Wall Cover Plate BAYCOVR800A
- Limited Warranty: 5 yr. base/10 yr. registered

## Application:

HVAC system compatibility:

- AccuLink™ II communicating systems (variable speed and two stage)
- Conventional gas/electric, heat pump, dual fuel systems, or boiler systems (forced air only) with use of relay panel model BAY24VRPAC52DB. Relay panel controls up to 5 stages heat, 2 stages cool, remote indoor and outdoor connections, humidifier, dehumidifier, and ventilation system.

## Dimensions:

- Product: 5.43"w x 3.39"h x 1.30"d
- Display: 4.15"w x 2.65"h

<sup>1</sup> Requires high speed router, internet service, and connection to Nexia™ Home Intelligence.

<sup>2</sup> Nexia Remote Climate Access is included with the purchase of a Connected Control. Adding accessories to your Nexia system requires a monthly subscription for remote access via most web-enabled smartphone and computers.

<sup>3</sup> Requires Nexia Bridge

For complete equipment / combination selections, installation instructions and warranty information, please refer to Product Data/Ratings and/or Installers Guides and Limited Warranty Handbooks.

## NEXIA Bridges & Starter Bundles

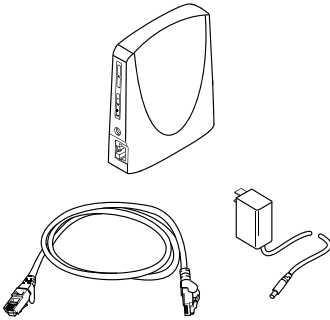

**NEXIA Bridge**

**NEXIA Bridge**

SKU: 811097020006

- Includes NEXIA Bridge (Z-Wave to broadband), ethernet cable, and power supply
- The NEXIA Bridge allows remote access of Z-Wave enabled devices through your smart phone, tablet, or P.C.
- Secure Connection with server for homeowner protection
- Easy Installation and Set-Up

**Application:**

Use with Nexia compatible Z-Wave devices.

**Dimensions:**

- NEXIA Bridge: 4.0" w x 4.8" h x 1.4" d
- Shipping Weight: 1 lb.

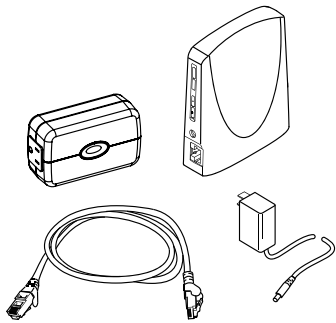

**NEXIA Bridge Starter Bundle with Home Appliance Module**

**NEXIA Home Starter Bundle**

SKU: 811097020129

- Includes NEXIA Bridge (Z-Wave to broadband), one RP100BX Home Appliance Module, ethernet cable, and power supply
- The NEXIA Bridge allows remote access of Z-Wave enabled devices through your smart phone, tablet, or P.C.
- Secure Connection with server for homeowner protection
- Easy Installation and Set-Up

**Application:**

- Use with Nexia compatible Z-Wave devices.

**Dimensions:**

- NEXIA Bridge: 4.0" w x 4.8" h x 1.4" d
- Home Appliance Module: 4.0" W x 2.4" H x 1.6" d
- Shipping Weight: 2 lbs.

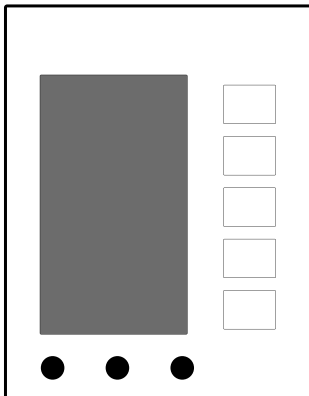

**NEXIA One Touch**

**NEXIA One Touch**

SKU: 811097020341

- Control smart products with the touch of a button
- Assign any mode or automation to any button
- 15 Programmable Presets
- Works stand-alone, no phone and computer required

**Application:**

- Power: 2 AAA Alkaline Batteries
- RF: 908.4 MHz
- Battery Life: Approximately 1 year
- Indoor Use Only
- Mounting: Includes screws and wall anchors

**Dimensions:**

- Size: 3.25" w x 4.58" h x .060" d
- Weight: 1 lb.

## NEXIA Compatible Products

### Dimmer Modules

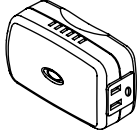

**Light Dimmer Module**

**Dimmer Light Module**

SKU: 811097020082

- Dimmer Light Module and Z-Wave Signal Repeater
- Used to control and dim plug-in incandescent lighting<sup>1</sup>

**Application:**

- Max load both outlets = 15 Amps, 1800 Watt resistive
- Max load Z Wave controlled outlet = 300 Watts incandescent only
- Shipping Weight: 1 lb.

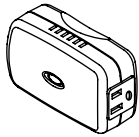

**Home Appliance Module**

**Appliance Module**

SKU: 811097020044

- Home Appliance Module and Z-Wave Signal Repeater
- Used to control small appliances and plug-in incandescent, fluorescent, and LED lighting. On/Off control<sup>1</sup>
- May be used to control/reduce standby loss from plug-in power supplies and small electronic loads

**Application:**

- Max load both outlets = 15 Amps, 1800 Watt resistive
- Max load Z Wave controlled outlet = 600 Watts incandescent, 1/2 HP, 1800 Watt resistive
- Shipping Weight: 1 lb.

### Lighting



**Z-Wave Light Bulb**

**LED Light Bulb**

SKU: 093863132995

- 60 watt equivalent LED dimmable Z-Wave light bulb
- Compatible with any certified Z-Wave based system such as Nexia Home Intelligence<sup>1</sup>
- Instant on and fully dimmable
- 22.8 years life at 3 hours per day average use
- 2700K soft white light
- Light can be activated, deactivated and fully dimmed remotely<sup>1</sup>
- Light can be triggered from compatible sensors and locks

**Application:**

- Protocol: Z-Wave
- Manufacturer: Linear
- Manufactured in China

**Unit Dimensions:**

- 2.95" x 4.92" x 2.95"
- Unit weight: 4.6 oz

**Case Dimensions:**

- Quantity - 10 units
- 4.5" x 3.3" x 5.3"

**Warranty**

- 1-Year Limited Warranty



**G.E. In-Wall Fan Control Switch**

**Fan Control Switch**

SKU: 030878127301

- Turn fan on/off and control up to three speed levels remotely from Nexia app
- Interchangeable paddles; white and light almond included in package (wall plate not included)
- Easy to install; includes space-saving screw terminals and neutral jumper wires
- Automate with Nexia based on temperature (with Z-Wave temperature sensor) or time of day
- Trigger actions from other smart products
- LED indicator glows in dark

**Application:**

- Protocol: Z-Wave
- Power: 120 VAC, 60Hz
- Max Load: 1.5A no more than two identical fans per switch not to exceed 1.5A resistive load - Controls Fan Motor Only - for use with split capacitor or shaded pole ceiling fan motors
- Operating Temperature: 0°C-40°C
- Indoor Use Only
- Specifications subject to change without notice

For complete equipment / combination selections, installation instructions and warranty information, please refer to Product Data/Ratings and/or Installers Guides and Limited Warranty Handbooks.

<sup>1</sup> Requires high speed router, internet service, and connection to Nexia™ Home Intelligence.

### Locks and Deadbolts

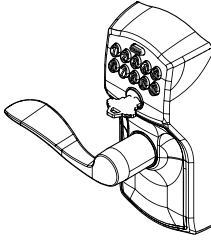

**Lever Lock**

#### Lever Lock

- Remotely engage/release locking mechanism from a computer or compatible web enabled mobile device <sup>1</sup>
- Confirm lock status from a computer or compatible web enabled mobile device <sup>1</sup>
- Assign up to 19 personalized 4 digit codes
- Up to 3 year battery life
- Provides battery level status at the lock and remotely <sup>1</sup>
- Available in 3 finishes: Bright Brass, Satin Nickel, Aged Bronze
- Class 2 rated door lock
- Lifetime limited mechanical and finish warranty
- 1-year limited electronics warranty

#### Model number and finish:

- BAY599BBALLFEA - Bright Brass  
SKU: 043156296231
- BAY599SNALLFEA - Satin Nickel  
SKU: 043156296248
- BAY599ABALLFEA - Aged Bronze  
SKU: 043156296255

#### Dimensions:

- Carton Size: 6" x 7.75" x 9.56"
- Shipping Weight: 5.5 lbs.

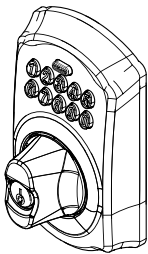

**Deadbolt**

#### Deadbolt Lock

- Remotely engage/release locking mechanism from a computer or compatible web enabled mobile device <sup>1</sup>
- Confirm lock status from a computer or compatible web enabled mobile device <sup>1</sup>
- Assign up to 19 personalized 4 digit codes
- Up to 3 year battery life
- Provides battery level status at the lock and remotely <sup>1</sup>
- Available in 3 finishes: Bright Brass, Satin Nickel, Aged Bronze
- Class 2 rated door lock
- Lifetime limited mechanical and finish warranty
- 1-year limited electronics warranty

#### Model number and finish:

- BAY369BBADBEEA - Bright Brass  
SKU: 043156295982
- BAY369SNADBEEA - Satin Nickel  
SKU: 043156296187
- BAY369ABADBEEA - Aged Bronze  
SKU: 043156296194

#### Dimensions:

- Carton Size: 5.75" x 7.93" x 8.5"
- Shipping Weight: 6 lbs.



## NEXIA Compatible Products

### Locks and Deadbolts

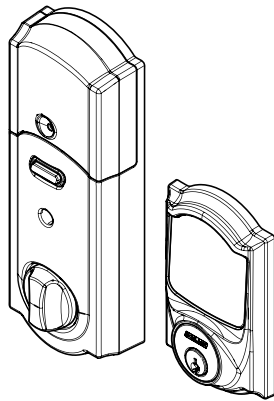

**Touchscreen Deadbolt  
Camelot**

#### Camelot Touchscreen Deadbolt

- Motorized bolt automatically locks and unlocks when code is entered
- Anti-pick shield protects against tampering
- Built-in alarm technology
- Remotely lock/unlock from a computer or compatible web enabled mobile device <sup>1</sup>
- Confirm lock status from a computer or compatible web enabled mobile device <sup>1</sup>
- Assign up to 30 personalized 4-8 digit codes
- Up to 3 year battery life
- Provides battery level status at the lock and remotely <sup>1</sup>

- Camelot touchscreen deadbolt available in Satin Nickel or Aged Bronze finish
- Lifetime limited mechanical and finish warranty
- 1-year limited electronics warranty

**Model number and finish:**

- BAY469SNACAMEA - Satin Nickel  
SKU: 043156312108
- BAY469ABACAMEA - Aged Bronze  
SKU: 043156312191
- BAY469BBACAMEA - Bright Brass  
SKU: 043156312207

**Dimensions:**

- Camelot: Inside 3.0"w x 5.0" H
- Inside 3.0"w x 8.28"h
- Shipping Weight: 3.8 lbs.



**Handleset with Interior Knob**

#### Lower Part of Schlage® Handleset with Interior Knob

- Lower part of handleset with knob in Satin Nickel, Aged Bronze or Bright Brass finish
- Lifetime limited mechanical and finish warranty

Finish	SKU
Satin Nickel	043156908325
Aged Bronze	043156908349
Bright Brass	043156908288



**Handleset with Interior Lever**

#### Lower Part of Schlage® Handleset with Interior Lever

- Lower part of handleset with lever in Satin Nickel, Aged Bronze or Bright Brass finish
- Available in left or right hand orientation
- Lifetime limited mechanical and finish warranty

L/R	Finish	SKU
LH	Satin Nickel	043156908233
RH	Satin Nickel	043156908226
LH	Aged Bronze	043156908271
RH	Aged Bronze	043156908264
LH	Bright Brass	043156908219
RH	Bright Brass	043156908202



**Gregorian Knobs & Levers**



Finish	SKU
Satin Nickel	043156994472
Aged Bronze	043156889938
Bright Brass	043156961245



Finish	SKU
Satin Nickel	043156791422
Aged Bronze	043156889914

For complete equipment / combination selections, installation instructions and warranty information, please refer to Product Data/Ratings and/or Installers Guides and Limited Warranty Handbooks.

<sup>1</sup> Requires high speed router, Nexia Bridge, internet service, and a Nexia™ Home Intelligence account.

## NEXIA Compatible Products

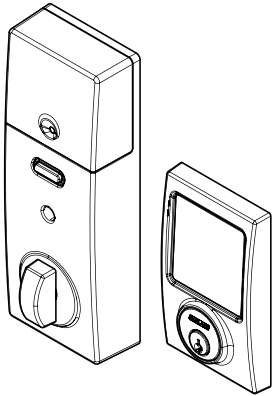

**Touchscreen Deadbolt  
Century**

### Century Touchscreen Deadbolt

- Motorized bolt automatically locks and unlocks when code is entered
- Anti-pick shield protects against tampering
- Built-in alarm technology
- Remotely lock/unlock from a computer or compatible web enabled mobile device <sup>1</sup>
- Confirm lock status from a computer or compatible web enabled mobile device <sup>1</sup>
- Assign up to 30 personalized 4-8 digit codes
- Up to 3 year battery life
- Provides battery level status at the lock and remotely <sup>1</sup>
- Century touchscreen deadbolt available in Satin Nickel finish only
  
- Lifetime limited mechanical and finish warranty
- 1-year limited electronics warranty

### Model number and finish:

- BAY469SNACENEA - Satin Nickel  
SKU: 043156312283

### Dimensions:

- Century: Outside 3.0"w x 5.0" H  
Inside 3.0"w x 8.17"h
- Shipping Weight: 3.8 lbs.

## NEXIA Compatible Products

### Remote Temperature Sensors

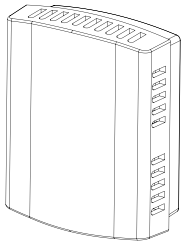

**Remote Indoor Sensor**

**ZZSENSAL0400AA**

- Remote Indoor Sensor for Use with AZONE950AC, ACONT850AC, ACONT824AS, ACONT624AS, ACONT402AN, ACONT401AN, BAY24VRPAC52D.
- Operating Ambient Temperature Range: 20° to 120°F (-6.7° to 48.9°C)
- Display Range: 20° to 120°F (-6.7° to 48.9°C)
- Sensor Accuracy: +/- .5°F at 75°F

- Operating Relative Humidity: 5% to 90% non-condensing

**Dimensions in. (mm):**

- 1.54 (39)w x 1.93 (49)h x .625 (1.6)d
- Storage Temperature: -40° to 140°F (-40° to 60°C)
- Finish: White

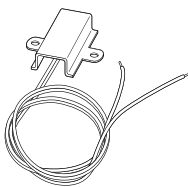

**Remote Outdoor Sensor**

**BAYSEN01ATEMPA**

- Remote Indoor Sensor for Use with AZONE950AC, ACONT850AC, ACONT824AS, ACONT624AS, ACONT402AN, ACONT401AN, BAY24VRPAC52D.

**Application:**

- Accuracy: +/- 1.5°F over 32°F to 100°F
- Display Range: -40°F to 140°F

### Wireless Cameras

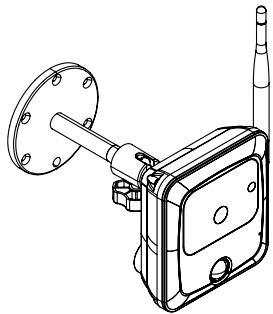

**Wireless Outdoor Camera**

**Wireless Outdoor Camera**

SKU: 811097020174

- NEXIA Web Camera - Wireless
- Indoor, fixed camera (power supply included)
- Remotely view and monitor your home from a computer or compatible web enabled mobile device <sup>1</sup>
- Secure Connection with server for homeowner protection
- Plug and Play with System
- infrared illumination for night vision

**Application:**

- Resolution: 1280 x 720, 640 x 480, 320 x 240 (QVGA)
- Video Compression: H.264, MJPEG
- Operating Temp: 32°F (0°C) to 104°F (40°C)
- Storage Temp: -4°F (-20°C) to 158°F (70°C)
- Wireless: IEEE 802.11n/802.11b, 802.11g compatible, WEP 64/128 bit, WPA/WPA2 personal security support
- Power Adapter: 12V/1A, 100~240VAC

**Dimensions:**

- 71mm W x 120mm H x 79mm D

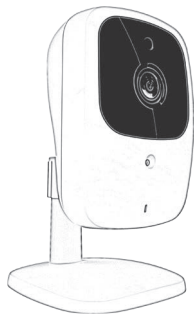

**Wireless Indoor Camera**

**Wireless Indoor Camera**

SKU: 811097020303

- Wireless Web Camera
- Outdoor, fixed camera (power supply included)
- Built in motion sensor (trigger video when motion detected) and infrared illumination for night vision
- Remotely view and monitor your home from a computer or compatible web enabled mobile device <sup>1</sup>
- Secure Connection with server for homeowner protection
- Plug and Play with System
- Privacy button

**Application:**

- Resolution: VGA (640x480)
- Operating Temp: -10C to 45C
- Wireless: 802.11b/g, WEP 64/128, WPA-PSK, WPA2

**Dimensions:**

- 1.5" W x 3.7" H x 4.1" d
- Shipping Weight: 2 lbs

<sup>1</sup> Requires high speed wireless router, internet service, and a Nexia™ Home Intelligence account.

**Security Sensors & Alarms**

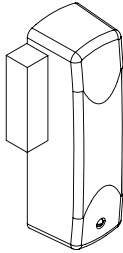

**Door/Window Sensor**

**Door/Window Sensor**

SKU: 811097020105

- Door / Window Sensor
- Reports open/closed status of doors and windows<sup>1</sup>
- Set NEXIA to send notification when doors or windows are opened <sup>1</sup>
- Set NEXIA to change the thermostat setting when windows have been opened or closed <sup>1,2</sup>
- Simple installation and set up
- Up to 3-year battery life for normal usage, no wiring required

- For indoor use
- White and brown cover available to match your door or window

**Application:**

- Operating Temp -0°C to 49°C
- Range: 60 ft
- Operating frequency: 908.41 MHz

**Dimensions:**

- 3.5"w x 1.75"h x 1" d
- Shipping weight: 1 lb

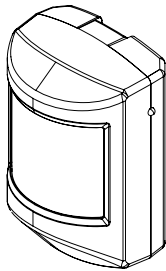

**Motion Sensor**

**Motion Sensor**

SKU: 811097020112

- Motion Sensor
- Text or e-mail alert when activity is detected<sup>1</sup>
- Trigger Nexia compatible cameras when motion is detected <sup>1,3</sup>
- Set up to turn on lights when there is activity present<sup>1</sup>
- Simple installation and set up
- Up to 3 year battery life
- For indoor use

**Application:**

- Operating Temp -0°C to 49°C
- Range: 60 ft
- Detection area: 20' \* 39' (radial distance)
- Detection angle: 90 degrees
- Operating frequency: 908.41 MHz
- Pet immunity: Set at approx. 50 lbs / 22.7 kg. Optional

**Dimensions:**

- 3.5"w x 2.5"h x 2"d
- Shipping weight: 1 lb



**Fibaro Z-Wave Multi Sensor**

**Z-Wave Multi Sensor**

SKU: 857934005256

- Detects motion, temperature and light
- Fully integrated to trigger Nexia Automations
- Multiple LED options for signaling motion detection
- Tamper and low-battery alarm notifications
- Easy installation, no wiring required
- Powered by CR123A, 3.6v battery
- Recommended installation height is 2.4 m or 7' 7/8"

**Application:**

- Operating Temp - 0°C to 40°C
- Range: Up to 50 m outdoors, up to 30 m indoors
- Operating frequency: 908 MHz US
- Light Intensity Measuring Range: 0-32000 LUX
- Measured Temp Range:-20 - 100°C
- Temperature Measuring Accuracy: 0.5°C (within 0°C to 40°C range)

**Dimensions:**

- 1.732" x 1.732" x 1.732"
- Shipping weight: 1 lb

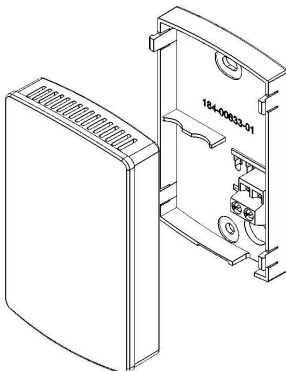

**Z-Wave Doorbell Sensor**

**Z-Wave Doorbell Sensor**

SKU: 811097020396

- Detects and alerts when doorbell button is pressed
- Fully integrated to trigger Nexia Automations
- Easy installation

**Application:**

- Power: 2 AAA Alkaline Batteries
- RF: Z-Wave ZM5202, US 908.4 MHz
- Doorbell Connection: 2 Wire Polarized
- Voltage: 14-40 VAC
- Wire Input: 16-24 Ga Solid Wire

**Dimensions:**

- 3.2" x 2.0" x 0.60"
- Weight: .25 lb

<sup>1</sup> Requires high speed router, Nexia Bridge, internet service, and a Nexia™ Home Intelligence account.

<sup>2</sup> Requires Nexia compatible connected control

<sup>3</sup> Requires Nexia compatible camera

For complete equipment / combination selections, installation instructions and warranty information, please refer to Product Data/Ratings and/or Installers Guides and Limited Warranty Handbooks.

## NEXIA Compatible Products



**Sounder/Strobe**

**Sounder/Strobe**

SKU: 093863125058

- Z-Wave Sounder/Strobe
- Certified for use with Nexia™ Home Intelligence<sup>1</sup>
- 105DB at 1m
- 360 lumen, 4 LED strobe light
- Battery backup
- Siren only/strobe only/siren and strobe modes
- For non-life safety applications
- 1-year limited warranty

**Application:**

- Protocol: Z-Wave
- Manufacturer: Linear
- Manufactured in Taiwan

**Unit Dimensions:**

- 3" x 4.6" x 1.6"
- Shipping weight: 11 oz

**Case Dimensions:**

- Quantity - 18 units
- 11" x 11" x 15"
- Shipping weight: 2 lbs, 9 oz

**Warranty**

- 7-Year Limited Warranty



**Smoke/Carbon Monoxide Alarm**

**Smoke/Carbon Monoxide Alarm**

SKU: 029054013026

- Certified for use with Nexia™ Home Intelligence<sup>1</sup>
- Combination Smoke & Carbon Monoxide Alarm
- Set Nexia to send alerts when alarm is triggered
- Photoelectric smoke sensor helps reduce false alarms such as from cooking or shower steam
- Mute unwanted alarms or test the alarm function with a simple button push
- 2 AA batteries included
- 7-year limited warranty

**Application:**

- Protocol: Z-Wave
- Manufacturer: First Alert
- Manufactured in Mexico

**Unit Dimensions:**

- 8.75"w x 7"h x 2.5"d
- Shipping weight: 11 oz

**Case Dimensions:**

- Quantity - 3 units
- 9"w x 7"h x 7.6"d
- Shipping weight: 2 lbs, 9 oz

**Warranty**

- 7-Year Limited Warranty



**GoControl™ Glass Break Sensor**

**GoControl™ Glass Break Sensor-**

SKU: 093863133282

- Nexia Certified device produced
- Fully supported by Nexia web and mobile applications
- Detects the sounds of breaking glass
- Easily mounts near any window or door susceptible to break-in
- Can be customized to send immediate alerts to phone or email
- Can communicate with other Nexia-enrolled devices. For example: Automate your smart lights to turn on and your siren and strobe light to activate the moment a window is broken.

- Operating Temperature: 32°F-120°F
- Country of Origin: China

**Unit Dimensions:**

- 5.0"w x 5.3"h x 2.6"d
- Weight: 7.3 oz.

**Case Dimensions:**

- Quantity - 24 units
- 20"w x 12"h x 8"d
- Minimum Order: 1 Case
- Standard Lead Time: Stock
- Warranty: 1 year

**Application**

- Mounts within 15' of window or door
- Includes 2 lithium batteries and mounting hardware
- Indoor use only

For complete equipment / combination selections, installation instructions and warranty information, please refer to Product Data/Ratings and/or Installers Guides and Limited Warranty Handbooks.

<sup>1</sup> Requires high speed wireless router, internet service, and a Nexia™ Home Intelligence account.

## NEXIA Compatible Products

### Garage Door Controller



Garage Door Controller

#### Garage Door Controller

SKU: 093863124389

- Nexia Certified device produced by Linear Technologies
- Fully supported by Nexia web and mobile applications
- Actuates a garage door opener remotely
- AC line powered
- Includes battery-powered Tilt Sensor that is mounted on the garage door that reports door position
- Produces audible and visual signals for safety purposes
- Certified to ETL Standard for Moving Barriers, Z-Wave Standards and Nexia product certification standards
- Easy installation
- Integrates with most existing multi-section doors (after 1993) and suitable for installation on existing or new garage door opening systems of many brands

- Does not include garage door opener, or garage door
- Compatible with most garage door openers that accept a standard push button input. Not compatible with openers using a proprietary communication protocol to the wall switch such as Genie Series II and the MyQ system.

#### Unit Dimensions:

- 9.27"w x 7.04"h x 4.5"d
- Shipping weight: 2 lbs

#### Case Dimensions:

- Quantity - 3 units
- 10.3"w x 24.1"h x 7.9"d
- Shipping weight: 11.2 lbs

# Home Energy Management eMonitor™ Hardware and Accessories

**Table CHS-12-A — eMonitor™ Energy Management Kit**

Model No.	Description	Dimensions (in.) H x W x D	Weight (lbs.)
eMonitor 4-14	14 Circuit energy monitor with factory confi. WiFi gateway <sup>①</sup>	17 <sup>11</sup> / <sub>16</sub> x 7 <sup>1</sup> / <sub>16</sub> x 9 <sup>5</sup> / <sub>16</sub>	5
eMonitor 4-14s	14 Circuit subpanel energy monitor without gateway <sup>②</sup>	17 <sup>11</sup> / <sub>16</sub> x 7 <sup>1</sup> / <sub>16</sub> x 9 <sup>5</sup> / <sub>16</sub>	5
eMonitor 4-24	24 Circuit energy monitor with factory confi. WiFi gateway <sup>①</sup>	17 <sup>11</sup> / <sub>16</sub> x 7 <sup>1</sup> / <sub>16</sub> x 9 <sup>5</sup> / <sub>16</sub>	7
eMonitor 4-24s	24 Circuit subpanel energy monitor without gateway <sup>②</sup>	17 <sup>11</sup> / <sub>16</sub> x 7 <sup>1</sup> / <sub>16</sub> x 9 <sup>5</sup> / <sub>16</sub>	7
eMonitor 4-44	44 Circuit energy monitor with factory confi. WiFi gateway <sup>①</sup>	17 <sup>11</sup> / <sub>16</sub> x 7 <sup>1</sup> / <sub>16</sub> x 9 <sup>5</sup> / <sub>16</sub>	10
eMonitor 4-44s	44 Circuit subpanel energy monitor without gateway <sup>②</sup>	17 <sup>11</sup> / <sub>16</sub> x 7 <sup>1</sup> / <sub>16</sub> x 9 <sup>5</sup> / <sub>16</sub>	10
eMonitor 4-24demo	24 Circuit energy monitor with factory confi. WiFi gateway <sup>②</sup> (5 year license key)	17 <sup>11</sup> / <sub>16</sub> x 7 <sup>1</sup> / <sub>16</sub> x 9 <sup>5</sup> / <sub>16</sub>	7
eMonitor 4-44demo	44 Circuit energy monitor with factory confi. WiFi gateway <sup>②</sup> (5 year license key)	17 <sup>11</sup> / <sub>16</sub> x 7 <sup>1</sup> / <sub>16</sub> x 9 <sup>5</sup> / <sub>16</sub>	10

① Requires Nexia account and supplemental eMonitor service plan.

② Requires Nexia account - includes 5 year license key - For dealer demo use only; limit 3 per dealership.

**Table CHS-12-B — eMonitor™ Energy Management Kit Components**

MODEL	150A CT's	50A CT's	20A CT's	EXPANSION PODS	BASE UNIT	GATEWAY	POWER SUPPLY	INSTALLATION INSTRUCTIONS
eMonitor 4-14	2	6	6	0	1	1	1	1
eMonitor 4-14s	0	6	8	0	1	0	1	1
eMonitor 4-24	2	6	16	1	1	1	1	1
eMonitor 4-24s	0	6	18	1	1	0	1	1
eMonitor 4-44	2	10	32	3	1	1	1	1
eMonitor 4-44s	0	10	34	3	1	0	1	1
eMonitor 4-24demo	2	6	16	1	1	1	1	1
eMonitor 4-44demo	2	10	32	3	1	1	1	1

**Table CHS-12-C — eMonitor™ Energy Accessories**

Model No.	Description
CT150A-6PACK	150 Amp clip on current transformer (CT) - 6 per package (3 pairs)
CT50A-10PACK	50 Amp clip on current transformer (CT) - 10 per package (5 pairs)
CT20A-10PACK	20 Amp clip on current transformer (CT) - 10 per package (5 pairs)
XPOD-W-CTS	10 Circuit expansion module with 8-20 Amp CT's and 2-50 Amp CT's
XPOD-R	10 Circuit expansion module without CT's

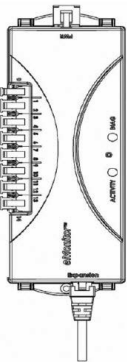

**Base Module**

**Base Module**

**Connections**

- 14 CT Sensor ports
- Six Pin eMonitor™ expansion module
- Modular power connector (120 VAC)

**Communication Protocols**

- Elink wireless 2.4GHz connection to eMonitor™ gateway
- RS485 LiNK protocol to Pin eMonitor™ expansion pod

**Power Requirements**

- 120 VAC, 60 Hz connection

**Dimensions and Weight**

- 7" x 2.5" x 1.875" (L x H x W)
- Weight - 4 oz.

# Home Energy Management eMonitor™ Hardware and Accessories

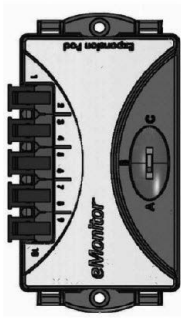

**XPOD**

**XPOD Expansion Pack Connections**

- 10 CT Sensor ports
- 2 x Six Pin eMonitor expansion module

**Communication Protocols**

- RS485 LiNK protocol to Pin eMonitor expansion pod

**Power Requirements**

- 120 VAC, 60 Hz, 2.5 W

**Dimensions and Weight**

- 3.75" x 1.875" x 0.875" (L x H x W)
- Weight - 2 oz.

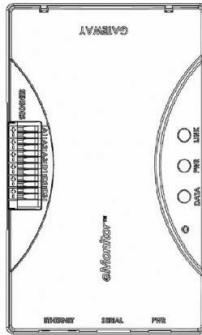

**Gateway**

**Gateway Connections**

- 1 x 10/100 RJ-45 Ethernet port
- 1 x High speed RJ-14 serial port
- 3 Analog inputs - Wire pair +/- 2V;
- 3 digital input/outputs

**Communication Protocols**

- Wi-Fi/802.11/B (Field convertible to ethernet. Contact Nexia customer support for assistance)
- Wireless 2.4 GHz connection to base module
- TCP-IP via ethernet (802.3) 10/100BASE-T

**Power Requirements**

- 120 VAC, 60 Hz connection

**Dimensions and Weight**

- 5.25" x 3.25" x 1.5" (L x H x W)
- Weight - 6 oz.

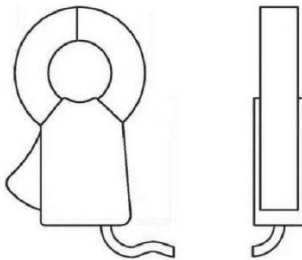

**CT150A**

**150A CT**

- Maximum operating voltage: 600 VAC
- Frequency: 50 Hz to 400 Hz
- Leads: 0.61m (2 ft), AWM 1015, twisted pair, 0.34mm<sup>2</sup> (22AWG), 600V

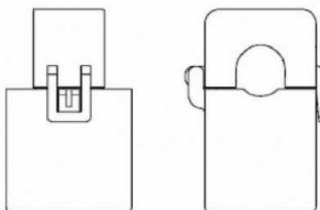

**CT50A or CT20A**

**CT50A or CT20A**

- Maximum operating voltage: 720 VAC
- Frequency: 50 Hz to 400 Hz
- Leads: 0.61m (2 ft), AWM 1015, twisted pair, 0.34mm<sup>2</sup> (22AWG), 600V



# AccuComfort™ Variable Speed Cooling Single Phase – 2-5 Tons

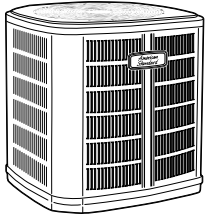

**Platinum 20  
(Variable Speed)**

**Table SC-1-A — Platinum 20 R-410A AccuComfort™ Variable Speed Cooling (30–100% capacity)—with AccuLink™ ①**

Model Number	Power Supply	Uncrated Dimensions(in.)			Shipping Weight (lbs.)	Sound** Rating	MCA*	Max. Fuse*	Line Size (in)	
		H	W	D					OD Gas	OD Liq.
4A7V0024A1000B	208/230/1/60	41	33	30	217	57/66	17	25	5/8	3/8
4A7V0036B1000B	208/230/1/60	41	37	34	228	59/70	18	25	3/4	3/8
4A7V0048A1000B	208/230/1/60	41	37	34	270	57/74	23	35	7/8	3/8
4A7V0060A1000B	208/230/1/60	45	37	34	284	62/75	27	40	1 1/8	3/8
4A7V0061A1000B	208/230/1/60	45	37	34	314	62/75	27	40	1 1/8	3/8

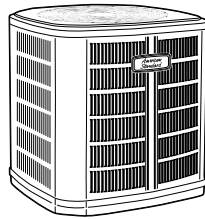

**Platinum 18  
(Variable Speed)**

**Table SC-1-B — Platinum 18 R-410A AccuComfort™ Variable Speed Cooling (30–100% capacity)—with AccuLink™ ①**

Model Number	Power Supply	Uncrated Dimensions(in.)			Shipping Weight (lbs.)	Sound** Rating	MCA*	Max. Fuse*	Line Size (in)	
		H	W	D					OD Gas	OD Liq.
4A7V8024A1000B	208/230/1/60	41	33	30	217	57/66	17	25	5/8	3/8
4A7V8036A1000B	208/230/1/60	41	33	30	228	55/70	18	25	3/4	3/8
4A7V8037A1000B	208/230/1/60	41	37	34	248	59/70	18	25	3/4	3/8
4A7V8048A1000B	208/230/1/60	41	37	34	270	57/74	23	35	7/8	3/8
4A7V8060A1000B	208/230/1/60	45	37	34	284	62/75	27	40	1 1/8	3/8

① Must use ACONT850 or AZONE950 control.

\* Information subject to change. Please confirm with current Product Data/Service Facts for current factory production.

\*\* Rated in accordance with AHRI Standard 270-2008 (Min/Max when applicable).

# AccuComfort™ Variable Speed Cooling Single Phase – 2-5 Tons

Split System Cooling

Table SC-2-A — Features	Platinum 20 (4A7V0)	Platinum 18 (4A7V8)
• SEER up to .....	22.00	18.00
• <b>Duration™</b> compressor .....	1	1
• Number of stages .....	Variable	Variable
• <b>Comfort-R™</b> mode approved .....	✓	✓
• <b>AccuLink™</b> system .....	✓	✓
• <b>DuraBase™</b> base, fast complete drain, weatherproof .....	✓	✓
• <b>Easy-Sess™</b> cabinet, service access .....	✓	✓
• <b>Spine Fin™</b> coil .....	✓	✓
• Compressor sound enclosure .....	✓	✓
• Compressor sump heat .....	✓	✓
• Factory supplied charge .....	R-410A	R-410A
• Glossy corrosion resistant finish .....	✓	✓
• High pressure switch .....	✓	✓
• Low pressure switch .....	✓	✓
• Internal high / low pressure & temperature protection .....	✓	✓
• Liquid line filter drier - factory installed or factory supplied for field install .....	✓	✓
• Quick start kit-factory installed .....	NA	NA
• Seacoast shield - factory installed .....	✓	—
• Spinnaker gray cabinet .....	✓	✓
• <b>12-year registered limited warranty on compressor, 10-year on outdoor coil &amp; all other functional parts (Residential Use)①</b> .....	✓	✓
• <b>Extended warranties available</b> .....	✓	✓

**Table SC-2-B — Optional Accessories**

Model Number	Description	Shipping Weight		
BAYECMT023	Extreme Conditions Mounting Kit (Base 2/3)	2	2	2
BAYECMT004	Extreme Conditions Mounting Kit (Base 4)	2	3-5	3-5
BAYISLT101	Rubber Isolators	1	✓	✓
BAYLEGS002	Snow Legs - Base and Cap 6" High (Black)	1	✓	✓
BAYLEGS003	4" Extension (Black)	1	✓	✓
BAYSEAC001	Seacoast Kit	1	—	✓
PAI00309②	Heresite Spraypaint	1	✓	✓

**Comfort Controls — See Comfort Controls/Zone Sensors Section**

- ① Registered Limited Warranty terms are available when you register within 60 days of installation. You can register online at [americanstandardair.com](http://americanstandardair.com) or by phone at 800-554-8005; otherwise American Standard Heating & Air Conditioning's Base Limited Warranty terms will apply. Base Limited Warranty information on specific products can be found on [ASDealerNet.com](http://ASDealerNet.com).
- ② Used for additional seacoast corrosion protection. Refer to bulletin number UN-SVB11A-EN for application information.

# Split System Cooling Single Phase – 1½-5 Tons

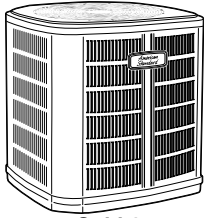

**Gold 17  
(Two Stage)**

**Table SC-3-A — Gold 17 R-410A Split System Two Stage Cooling (70/100% capacity)**

Model Number	Power Supply	Nom. Cap. Cooling (BTUH)	Uncrated Dimensions(in.)			Shipping Weight (lbs.)	Sound** Rating	MCA*	Max. Fuse*	Line Size (in)	
			H	W	D					OD Gas	OD Liq.
4A7A7024A1000B	208/230/1/60	24,000	41	37	34	276	72	15	25	5/8	3/8
4A7A7036A1000B	208/230/1/60	36,000	45	37	34	283	72	20	35	3/4	3/8
4A7A7048A1000B	208/230/1/60	48,000	45	37	34	291	73	27	45	7/8	3/8
4A7A7060A1000B	208/230/1/60	60,000	45	37	34	312	74	37	60	1 1/8	3/8

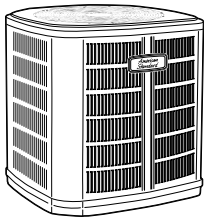

**Silver 16  
(Single Stage)**

**NEW for 2016!**

**Table SC-3-B — Silver 16 R-410A Split System Single Stage Cooling**

Model Number	Power Supply	Nom. Cap. Cooling (BTUH)	Uncrated Dimensions(in.)			Shipping Weight (lbs.)	Sound** Rating	MCA*	Max. Fuse*	Line Size (in)	
			H	W	D					OD Gas	OD Liq.
4A7A6018J1000A	208/230/1/60	18,000	29	33	30	189	73	12	20	3/4	3/8
4A7A6024J1000A	208/230/1/60	24,000	29	33	30	190	73	14	25	3/4	3/8
4A7A6030J1000A	208/230/1/60	30,000	37	33	30	220	73	17	25	3/4	3/8
4A7A6036J1000A	208/230/1/60	36,000	37	37	34	246	71	18	30	7/8	3/8
4A7A6042J1000A	208/230/1/60	42,000	45	37	34	302	72	21	35	7/8	3/8
4A7A6048J1000A	208/230/1/60	47,000	45	37	34	306	72	24	40	7/8	3/8
4A7A6049J1000A	208/230/1/60	48,000	45	37	34	322	72	26	40	7/8	3/8
4A7A6060J1000A	208/230/1/60	57,500	45	37	34	327	72	32	50	1 1/8	3/8
4A7A6061J1000A	208/230/1/60	60,000	45	37	34	327	74	32	50	1 1/8	3/8

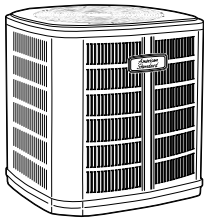

**Silver 16  
(Single Stage)**

**Table SC-3-C — Silver 16 R-410A Split System Single Stage Cooling**

Model Number	Power Supply	Nom. Cap. Cooling (BTUH)	Uncrated Dimensions(in.)			Shipping Weight (lbs.)	Sound** Rating	MCA*	Max. Fuse*	Line Size (in)	
			H	W	D					OD Gas	OD Liq.
4A7A6018H1000K	208/230/1/60	18,000	29	33	30	200	75	9	15	5/8	3/4
4A7A6024H1000A	208/230/1/60	24,000	29	33	30	201	75	9	15	3/4	3/8
4A7A6030H1000A	208/230/1/60	30,000	33	37	34	234	75	15	25	3/4	3/8
4A7A6036H1000A	208/230/1/60	36,000	37	37	34	228	75	19	30	3/4	3/8
4A7A6042H1000A	208/230/1/60	42,000	41	37	34	272	75	23	40	7/8	3/8
4A7A6048H1000K	208/230/1/60	48,000	45	37	34	282	75	26	45	7/8	3/8
4A7A6049H1000A	208/230/1/60	48,000	45	37	34	304	74	26	45	7/8	3/8

\* Information subject to change. Please confirm with current Product Data/Service Facts for current factory production.

\*\* Rated in accordance with AHRI Standard 270-2008 (Min/Max when applicable).

# Split System Cooling Single Phase – 1½-5 Tons

Split System Cooling

**Table SC-4-A — Features**

	Gold 17 (4A7A7)	Silver 16 (4A7A6-J)	Silver 16 (4A7A6-H)
• SEER up to .....	18.00	17.00	17.00
• <b>Duration™</b> compressor .....	1	1	1
• Number of stages .....	2	1	1
• <b>Comfort-R™</b> mode approved .....	✓	✓	✓
• <b>DuraBase™</b> base, fast complete drain, weatherproof .....	✓	✓	✓
• <b>Easy-Sess™</b> cabinet, service access .....	✓	✓	✓
• <b>Spine Fin™</b> coil .....	✓	✓	✓
• Compressor sound enclosure .....	—	—	024-048
• Factory supplied charge .....	R-410A	R-410A	R-410A
• Glossy corrosion resistant finish .....	✓	✓	✓
• High pressure switch .....	✓	✓	✓
• Low pressure switch .....	✓	—	036
• Internal high / low pressure & temperature protection .....	✓	✓	✓
• Liquid line filter drier - factory installed or factory supplied for field install .....	✓	✓	✓
• Quick start kit-factory installed .....	—	1½-2	018-030,060
• Seacoast shield - factory installed .....	✓	—	✓
• Spinnaker gray cabinet .....	✓	✓	✓
• <b>12-year registered limited warranty on compressor, 10-year on outdoor coil &amp; all other functional parts (Residential Use) ①</b> .....	✓	—	✓
• <b>10-year registered limited warranty on compressor, outdoor coil &amp; all other functional parts (Residential Use) ①</b> .....	—	✓	✓
• <b>Extended warranties available</b> .....	✓	✓	✓

**Table SC-4-B — Optional Accessories**

Model Number	Description	Shipping Weight			
AY28X079.....	Evaporator defrost control .....	1	✓	✓	✓
BAYCCHT301 .....	Crankcase Heater Kit (Scroll) .....	1	✓	3½-5	✓
BAYCCHT302 .....	Crankcase Heater Kit (Scroll) .....	1	—	1½-3	—
BAYECMT023 .....	Extreme Conditions Mounting Kit (Base 2/3) .....	2	—	1½-2½	—
BAYECMT004 .....	Extreme Conditions Mounting Kit (Base 4) .....	2	✓	3-5	✓
BAYISLT101 .....	Rubber Isolators .....	1	✓	✓	✓
BAYKSKT263 .....	Start kit .....	1	2-3	2½-5	036-049
BAYKSKT266 .....	Start kit .....	1	4-5	—	—
BAYLEGS002 .....	Snow Legs - Base and Cap 6" High (Black) .....	1	✓	✓	✓
BAYLEGS003 .....	4" Extension (Black) .....	1	✓	✓	✓
BAYLOAM103 .....	Low Ambient Kit .....	1	—	✓	✓
BAYSEAC001 .....	Seacoast Kit .....	1	—	✓	✓
BAYSDEN003 .....	Small Scroll Compressor Enclosures .....	8	2-3	1½-3	—
BAYSDEN004 .....	Small Scroll Compressor Enclosures .....	8	4-5	3½-5	049
TAYASCT501A ②③ .....	Anti-Short Cycle Timer .....	2	✓	✓	✓
TAYSVPANL0032AA ...	Service Valve Panel Cover Kit .....	2	—	1½-2	1½-2
TAYSVPANL3343AA ...	Service Valve Panel Cover Kit .....	2	2	—	2½
TAYSVPANL0044AA ...	Service Valve Panel Cover Kit .....	2	3-5	2½-3	3
TAYSVPANL3545AA ...	Service Valve Panel Cover Kit .....	2	—	—	3½
TAYSVPANL0046AA ...	Service Valve Panel Cover Kit .....	2	—	3½-5	4-5
PAI00309 ④ .....	Heresite Spraypaint .....	1	✓	✓	✓

**Comfort Controls — See Comfort Controls/Zone Sensors Section**

- ① Registered Limited Warranty terms are available when you register within 60 days of installation. You can register online at americanstandardair.com or by phone at 800-554-8005; otherwise American Standard Heating & Air Conditioning's Base Limited Warranty terms will apply. Base Limited Warranty information on specific products can be found on ASDealerNet.com.
- ② Not for use with programmable thermostats.
- ③ Activated on power off.
- ④ Used for additional seacoast corrosion protection. Refer to bulletin number UN-SVB11A-EN for application information.

# Split System Cooling Single Phase – 1½-5 Tons

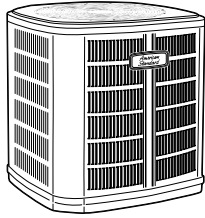

**Silver 14  
(Single Stage)**

**Table SC-5-A — Silver 14 R-410A Split System Single Stage Cooling**

Model Number	Power Supply	Nom. Cap. Cooling (BTUH)	Uncrated Dimensions(in.)			Shipping Weight (lbs.)	Sound** Rating	MCA*	Max. Fuse*	Line Size (in)	
			H	W	D					OD Gas	OD Liq.
4A7A4018L1000A	208/230/1/60	17,000	29	29	26	153	72	12	20	3/4	3/8
4A7A4024L1000A <sup>①</sup>	208/230/1/60	23,600	29	29	26	153	72	14	25	3/4	3/8
4A7A4025L1000A	208/230/1/60	23,600	29	29	26	153	72	14	25	3/4	3/8
4A7A4030L1000A <sup>①</sup>	208/230/1/60	28,400	29	33	30	183	73	17	25	3/4	3/8
4A7A4031L1000A	208/230/1/60	28,400	29	33	30	183	73	17	25	3/4	3/8
4A7A4036L1000A <sup>①</sup>	208/230/1/60	34,000	33	33	30	183	73	18	30	3/4	3/8
4A7A4037L1000A	208/230/1/60	34,000	33	33	30	183	73	18	30	3/4	3/8
4A7A4042L1000A <sup>①</sup>	208/230/1/60	40,500	29	37	34	216	72	22	35	7/8	3/8
4A7A4043L1000A	208/230/1/60	40,500	29	37	34	216	72	22	35	7/8	3/8
4A7A4048L1000A	208/230/1/60	47,000	29	37	34	212	72	24	40	7/8	3/8
4A7A4060L1000A	208/230/1/60	56,000	37	37	34	246	72	31	50	7/8	3/8

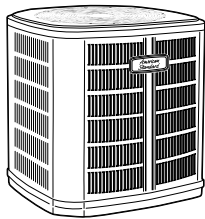

**Silver 13  
(Single Stage)**

**Table SC-5-B — Silver 13 R-410A Split System Single Stage Cooling**

Model Number	Power Supply	Nom. Cap. Cooling (BTUH)	Uncrated Dimensions(in.)			Shipping Weight (lbs.)	Sound** Rating	MCA*	Max. Fuse*	Line Size (in)	
			H	W	D					OD Gas	OD Liq.
4A7A3018H1000N <sup>②</sup>	208/230/1/60	17,000	29	29	26	153	72	12	20	3/4	3/8
4A7A3024H1000N <sup>②</sup>	208/230/1/60	23,000	29	29	26	150	74	18	30	3/4	3/8
4A7A3030G1000N <sup>②</sup>	208/230/1/60	28,500	29	33	30	180	71	18	30	3/4	3/8
4A7A3036G1000N <sup>②</sup>	208/230/1/60	34,500	33	33	30	197	74	22	35	3/4	3/8
4A7A3042D1000N <sup>②</sup>	208/230/1/60	40,500	29	37	34	228	74	26	45	3/4	3/8
4A7A3048D1000N <sup>②</sup>	208/230/1/60	46,500	29	37	34	235	75	28	50	7/8	3/8
4A7A3060D1000N <sup>②</sup>	208/230/1/60	58,500	37	37	34	261	75	35	60	7/8	3/8

<sup>①</sup> Models are not legal for installation in California, Nevada, New Mexico and Arizona. All other models are legal for installation in all US zones and states.

<sup>②</sup> 13 SEER AC equipment manufactured after 1/1/16 can only be installed in the North Zone.

\* Information subject to change. Please confirm with current Product Data/Service Facts for current factory production.

\*\* Rated in accordance with AHRI Standard 270-2008 (Min/Max when applicable).

# Split System Cooling Single Phase – 1½-5 Tons

Split System Cooling

Table SC-6-A — Features	Silver 14 (4A7A4)	Silver 13 (4A7A3)
• SEER up to .....	16.00	14.75
• <b>Duration™</b> compressor .....	1	1
• Number of stages .....	1	1
• <b>Comfort-R™</b> mode approved .....	✓	✓
• <b>DuraBase™</b> base, fast complete drain, weatherproof .....	✓	✓
• <b>Easy-Sess™</b> cabinet, service access .....	✓	✓
• <b>Spine Fin™</b> coil .....	✓	✓
Factory supplied charge .....	R-410A	R-410A
• Glossy corrosion resistant finish .....	✓	✓
• High pressure switch .....	✓	✓
• Low pressure switch .....	✓	—
• Internal high / low pressure & temperature protection .....	✓	✓
• Liquid line filter drier - factory installed or factory supplied for field install .....	✓	✓
• Quick start kit-factory installed .....	1½-2	1½
• Spinnaker gray cabinet .....	✓	✓
• <b>10-year registered limited warranty on compressor, outdoor coil &amp; all other functional parts (Residential Use) ①</b> .....	✓	✓
• <b>Extended warranties available</b> .....	✓	✓

**Table SC-6-B — Optional Accessories**

Model Number	Description	Shipping Weight		
AY28X079 .....	Evaporator defrost control .....	1 .....	✓	✓
BAYCCHT300 .....	Crankcase Heater Kit (Reciprocating) .....	1 .....	—	1½-3
BAYCCHT301 .....	Crankcase Heater Kit (Scroll) .....	1 .....	3½-5	3½-5
BAYCCHT302 .....	Crankcase Heater Kit (Scroll) .....	1 .....	1½-3	3½-5
BAYECMT023 .....	Extreme Conditions Mounting Kit (Base 2/3) .....	2 .....	1½-3	1½-3
BAYECMT004 .....	Extreme Conditions Mounting Kit (Base 4) .....	2 .....	3½-5	3½-5
BAYISLT101 .....	Rubber Isolators .....	1 .....	✓	✓
BAYKSKT263 .....	Start kit .....	1 .....	2½-5	2-5
BAYLEGS002 .....	Snow Legs - Base and Cap 6" High (Black) .....	1 .....	✓	✓
BAYLEGS003 .....	4" Extension (Black) .....	1 .....	✓	✓
BAYLOAM103 .....	Low Ambient Kit .....	1 .....	✓	✓
BAYSEAC001 .....	Seacoast Kit .....	1 .....	✓	✓
TAYASCT501A ②③ .....	Anti-Short Cycle Timer .....	2 .....	✓	✓
TAYSVPANL0022AA ...	Service Valve Panel Cover Kit .....	2 .....	—	1½-2
TAYSVPANL0032AA ...	Service Valve Panel Cover Kit .....	2 .....	1½	2½-4
TAYSVPANL3343AA ...	Service Valve Panel Cover Kit .....	2 .....	2-3½	—
TAYSVPANL0044AA ...	Service Valve Panel Cover Kit .....	2 .....	4	5
TAYSVPANL0046AA ...	Service Valve Panel Cover Kit .....	2 .....	5	—
TAYPLUS103A .....	Heat Pump Control Kit .....	3 .....	✓	✓
PAI00309 ④ .....	Heresite Spraypaint .....	1 .....	✓	✓

**Comfort Controls — See Comfort Controls/Zone Sensors Section**

- ① Registered Limited Warranty terms are available when you register within 60 days of installation. You can register online at americanstandardair.com or by phone at 800-554-8005; otherwise American Standard Heating & Air Conditioning's Base Limited Warranty terms will apply. Base Limited Warranty information on specific products can be found on ASDealerNet.com.
- ② Not for use with programmable thermostats.
- ③ Activated on power off.
- ④ Used for additional seacoast corrosion protection. Refer to bulletin number UN-SVB11A-EN for application information.

# Split System Cooling

## Single, Three Phase and R-22

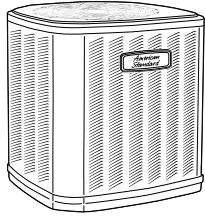

**Silver SI - 4TTB3**  
(Single Stage)

**Table SC-7-A — Silver SI R-410A Split System Single Stage Cooling**

Model Number	Power Supply	Nom. Cap. Cooling (BTUH)	Uncrated Dimensions(in.)			Shipping Weight (lbs.)	Sound** Rating	MCA*	Max. Fuse*	Line Size (in)	
			H	W	D					OD Gas	OD Liq.
4TTB3018H1000A	208/230/1/60	17,000	29	29	26	150	74	12	20	3/4	3/8
4TTB3024H1000A	208/230/1/60	23,000	29	29	26	150	74	18	30	3/4	3/8
4TTB3030G1000A	208/230/1/60	28,500	29	33	30	180	76	19	30	3/4	3/8
4TTB3036E1000A	208/230/1/60	34,500	29	33	30	186	74	20	35	3/4	3/8
4TTB3042D1000C	208/230/1/60	40,500	29	37	34	228	79	26	45	3/4	3/8
4TTB3048D1000C	208/230/1/60	46,500	29	37	34	235	79	28	50	7/8	3/8
4TTB3060D1000C	208/230/1/60	58,500	37	37	34	261	80	35	60	7/8	3/8

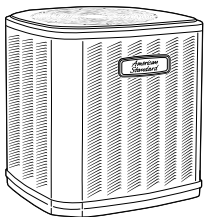

**Silver - 4TTA3**  
(Single Stage)

**Table SC-7-B — Silver 3-Phase R-410A Split System Single Stage Cooling**

Model Number	Power Supply	Nom. Cap. Cooling (BTUH)	Uncrated Dimensions(in.)			Shipping Weight (lbs.)	Sound** Rating	MCA*	Max. Fuse*	Line Size (in)	
			H	W	D					OD Gas	OD Liq.
4TTA3030A3000C	208/230/3/60	30,000	33	33	30	224	78	10	15	3/4	3/8
4TTA3036B3000A	208/230/3/60	36,000	29	33	30	176	78	14	20	3/4	3/8
4TTA3042D3000C	208/230/3/60	42,000	29	37	34	228	79	18	30	3/4	3/8
4TTA3048D3000C	208/230/3/60	48,000	29	37	34	235	79	18	30	7/8	3/8
4TTA3060D3000C	208/230/3/60	60,000	37	37	34	261	80	21	35	7/8	3/8
4TTA3030A4000C	460/3/60	30,000	33	33	30	222	78	5	15	3/4	3/8
4TTA3036B4000A	460/3/60	36,000	29	33	30	176	78	8	15	3/4	3/8
4TTA3042D4000C	460/3/60	42,000	33	37	34	228	79	8	15	3/4	3/8
4TTA3048D4000C	460/3/60	48,000	33	37	34	235	79	8	15	7/8	3/8
4TTA3060D4000C	460/3/60	60,000	41	37	34	261	80	10	15	7/8	3/8

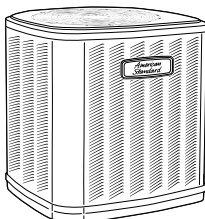

**2TTB3**  
(Single Stage)

**Table SC-7-C — R-22 Split System Dry Ship Replacement Single Stage Cooling**

Model Number	Power Supply	Nom. Cap. Cooling (BTUH)	Uncrated Dimensions(in.)			Shipping Weight (lbs.)	Sound** Rating	MCA*	Max. Fuse*	Line Size (in)	
			H	W	D					OD Gas	OD Liq.
2TTB3018A1000N①	208/230/1/60	17,000	26	29	26	182	76	8	15	5/8	1/4
2TTB3024A1000N①	208/230/1/60	23,000	33	29	26	195	78	12	20	3/4	5/16
2TTB3030A1000N①	208/230/1/60	28,500	33	33	30	225	78	13	20	3/4	5/16
2TTB3036A1000N①	208/230/1/60	34,500	33	33	30	205	76	21	35	7/8	3/8
2TTB3042A1000N①	208/230/1/60	40,500	33	37	34	283	79	21	35	7/8	3/8
2TTB3048A1000N①	208/230/1/60	46,500	41	37	34	307	79	25	40	1 1/8	3/8
2TTB3060A1000N①	208/230/1/60	58,500	41	37	34	280	79	33	50	1 1/8	3/8

① 13 SEER AC equipment manufactured after 1/1/16 can only be installed in the North Zone.

\* Information subject to change. Please confirm with current Product Data/Service Facts for current factory production.

\*\* Rated in accordance with AHRI Standard 270-2008.

# Split System Cooling

## Single, Three Phase and R-22

Split System Cooling

**Table SC-8-A — Features**

	4TTB3	4TTA3	2TTB3
• SEER up to .....	14.00	14.50	13.25
• <b>Comfort-R™</b> mode approved.....	✓	✓	✓
• <b>DuraBase™</b> base, fast complete drain, weatherproof .....	✓	✓	✓
• <b>Easy-Sess</b> cabinet, service access & refrigerant connections with full coil protection .....	✓	✓	✓
• <b>Spine Fin™</b> coil .....	✓	✓	✓
• <b>Duration™</b> coil .....	✓	✓	—
• Refrigerant - (R-22 not factory supplied).....	R-410A	R-410A	R-22
• Glossy corrosion resistant finish .....	✓	✓	✓
• Compressor sound enclosure .....	—	—	3½-4
• Internal high / low pressure & temperature protection .....	✓	✓	✓
• Liquid line filter drier - factory installed or factory supplied for field install .....	✓	✓	✓
• Polyslate gray cabinet .....	✓	✓	✓
• Start kit - factory installed.....	—	—	1½-2½,3½-4
• High and low pressure switch .....	✓	✓	—
• Tarpolin gray cabinet .....	—	—	✓
• <b>5-year basic limited warranty on compressor, 1-year on outdoor coil &amp; all other functional parts (Commercial Use)</b> .....	✓	✓	—
• <b>5-year registered limited warranty on compressor, outdoor coil &amp; all other functional parts (Residential Use)①</b> .....	—	—	✓
• <b>Extended warranties available</b> .....	✓	✓	✓

**Table SC-8-B — Optional Accessories**

Model Number	Description	Shipping Weight	4TTB3	4TTA3	2TTB3
AY28X079.....	Evap. Defrost Control Kit .....	1 .....	✓	✓	✓
BAYCCHT300 .....	Crankcase Heater Kit (Reciprocating) .....	1 .....	—	—	1½-2½,3½-4
BAYCCHT301 .....	Crankcase Heater Kit (Scroll) .....	1 .....	✓	—	3,5
BAYECMT023 .....	Extreme Conditions Mounting Kit (Base 2/3).....	2 .....	1½-3	2½-3	1½-3
BAYECMT004 .....	Extreme Conditions Mounting Kit (Base 4) .....	2 .....	3½-5	3½-5	3½-5
BAYISLT101 .....	Rubber Isolators.....	1 .....	✓	✓	✓
BAYKSKT260 .....	Start Kit .....	1 .....	—	—	3
BAYKSKT263 .....	Start kit.....	1 .....	✓	—	5
BAYLEGS002 .....	Snow Legs - Base and Cap 6" High (Black) .....	1 .....	✓	✓	✓
BAYLEGS003 .....	4" Extension (Black) .....	1 .....	✓	✓	✓
BAYLOAM103 .....	Low Ambient Kit .....	1 .....	✓	✓	✓
BAYSDEN001 .....	Single Cylinder Compressor Enclosures .....	8 .....	—	—	1½-2½
BAYSDEN003 .....	Small Scroll Compressor Enclosures.....	8 .....	1½-3	2½-4	3
BAYSDEN004 .....	Large Scroll Compressor Enclosures .....	8 .....	3½-5	5	5
BAYSEAC001.....	Seacoast Kit .....	1 .....	✓	✓	✓
TAYASCT501A②③ .....	Anti-Short Cycle Timer .....	2 .....	✓	✓	✓

**Comfort Controls — See Comfort Controls/Zone Sensors Section**

- ① Registered Limited Warranty terms are available when you register within 60 days of installation. You can register online at [americanstandardair.com](http://americanstandardair.com) or by phone at 800-554-8005; otherwise American Standard Heating & Air Conditioning's Base Limited Warranty terms will apply. Base Limited Warranty information on specific products can be found on [ASDealerNet.com](http://ASDealerNet.com).
- ② Not for use with programmable thermostats.
- ③ Activated on Power Off.



# Split System Heat Pumps Summary of System Ratings

**IMPORTANT:**

This table is intended as an at-a-glance overview. See AHRI for complete and up-to-date indoor and outdoor system ratings by model. Not all matches will attain ratings shown below.

Model Not Offered		NA-System Combination "Not Allowed"																				
Silver 14		Silver 14 - 14 SEER Single Stage Heat Pump and Air Handler Ratings Summary (up to 14 SEER / 12 EER / 8.5 HSPF)																				
		1.5 Ton			2 Ton			2.5 Ton			3 Ton			3.5 Ton			4 Ton			5 Ton		
		SEER	EER	HSPF	SEER	EER	HSPF	SEER	EER	HSPF	SEER	EER	HSPF	SEER	EER	HSPF	SEER	EER	HSPF	SEER	EER	HSPF
TEM / TMM Air Handlers	TEM4	14.00	11.50	8.20	14.00	11.50	8.20	14.00	11.50	8.50	14.00	11.50	8.50	14.00	11.50	8.50	14.00	11.50	8.50	14.00	11.50	8.20
	TMM5	14.00	12.00	8.20	14.00	12.00	8.20	14.00	12.00	8.20	14.00	12.00	8.20									
	TEM6	NA			14.50	12.00	8.50	14.50	12.00	8.50	14.50	12.00	8.50	NA			14.50	12.00	8.50	14.50	12.00	8.50
ForeFront™ Air Handlers	GAF2	14.00	11.50	8.20	14.00	11.50	8.20	14.00	12.00	8.20	14.00	12.00	8.20									
	GAM2	14.50	11.50	8.20	14.00	11.50	8.20	14.00	11.50	8.20	14.00	11.50	8.20	NA			14.00	11.50	8.20	14.00	11.50	8.50
	TAM4	14.00	11.50	8.20	14.00	11.50	8.20	14.00	11.50	8.50	14.00	11.50	8.20	NA			14.00	11.50	8.50	14.00	11.50	8.20
	GAM5	14.50	12.00	8.50	14.50	12.00	8.50	14.50	12.00	8.50	14.50	12.00	8.50	14.50	12.00	8.50	NA			14.50	12.00	8.50
	TAM7	14.50	12.00	8.40	14.50	12.00	8.50	14.50	12.00	8.50	14.50	12.00	8.50	14.50	12.00	8.50	14.50	12.00	8.50	14.50	12.00	8.50

Silver 15		Silver 15 - 15 SEER Single Stage Heat Pump and Air Handler Ratings Summary (up to 15 SEER / 12.5 EER / 9.5 HSPF)																				
		1.5 Ton			2 Ton			2.5 Ton			3 Ton			3.5 Ton			4 Ton			5 Ton		
		SEER	EER	HSPF	SEER	EER	HSPF	SEER	EER	HSPF	SEER	EER	HSPF	SEER	EER	HSPF	SEER	EER	HSPF	SEER	EER	HSPF
TEM / TMM Air Handlers	TEM3	14.50	12.00	8.50	14.50	12.00	8.20	14.00	12.00	8.20	NA			NA			NA			NA		
	TEM4	14.50	12.00	8.20	14.50	12.00	8.50	14.25	12.00	8.50	14.50	12.00	8.50	NA			NA			NA		
	TMM5	15.00	12.50	8.20	15.00	12.50	8.50	15.00	12.50	8.50	15.00	12.50	8.50									
	TEM6	NA			15.00	12.50	9.50	15.00	12.50	9.00	15.00	12.50	9.50	15.00	12.50	9.00	15.00	12.50	9.00	14.75	12.00	9.00
ForeFront™ Air Handlers	GAF2	15.00	12.50	8.50	15.00	12.50	8.50	14.00	12.00	8.50	NA											
	GAM2	14.50	12.00	8.50	14.50	12.00	9.00	14.00	12.00	8.50	14.25	12.00	9.00	14.50	12.00	8.50	15.00	12.00	8.50	14.50	12.00	8.50
	TAM4	14.50	12.00	8.50	14.50	12.00	9.00	14.25	12.00	9.00	14.25	12.00	9.00	14.50	12.00	8.50	15.00	12.00	8.50	14.50	12.00	8.50
	GAM5	15.00	12.50	8.50	15.00	12.50	9.00	15.00	12.50	8.50	15.00	12.50	9.00	15.00	12.50	9.00	15.75	12.50	8.50	14.00	12.00	8.50
	TAM7	15.00	12.50	8.40	15.50	13.00	9.00	16.00	13.00	9.00	15.00	12.50	9.00	15.50	12.50	9.00	15.50	12.50	9.00	15.00	12.50	8.50

Silver 16		Silver 16 - 16 SEER Single Stage Heat Pump and Air Handler Ratings Summary (up to 17 SEER / 13 EER / 9.6 HSPF)																							
		1.5 Ton			2 Ton			2.5 Ton			3 Ton			3.5 Ton			4 Ton			5 Ton					
		SEER	EER	HSPF	SEER	EER	HSPF	SEER	EER	HSPF	SEER	EER	HSPF	SEER	EER	HSPF	SEER	EER	HSPF	SEER	EER	HSPF			
TEM / TMM Air Handlers	TEM3	Available Q2 2016			14.00	11.50	8.20	NA			NA			NA			14.00	11.50	8.20	14.00	11.50	8.20			
	TEM4				15.00	12.00	8.20	NA			15.00	12.00	8.20	NA			15.00	12.00	8.20	14.75	12.00	8.20			
	TMM5				16.00	13.00	8.50	NA																	
	TEM6				16.00	13.00	9.60	16.00	13.00	9.60	16.00	13.00	9.60	16.00	13.00	9.60	16.00	13.00	9.60	16.00	13.00	9.60	15.00	12.50	9.00
ForeFront™ Air Handlers	GAF2	Available Q2 2016			14.00	12.00	8.20	NA			NA														
	GAM2				15.00	12.50	8.20	NA			14.75	12.50	8.50	15.00	12.00	8.50	15.00	12.00	8.50	15.00	12.00	8.50			
	TAM4				15.00	12.50	8.20	NA			14.75	12.50	8.50	15.00	12.00	8.50	15.00	12.00	8.50	15.00	12.00	8.50			
	GAM5				16.00	12.50	9.00	16.00	12.50	9.00	16.00	12.50	9.00	16.00	12.50	9.00	16.00	12.50	9.00	16.00	12.50	9.00	14.50	12.00	8.20
	TAM7				17.00	13.50	9.50	17.00	13.50	9.60	16.00	13.00	9.60	16.00	13.00	9.60	17.00	13.50	9.60	16.00	13.00	9.50	15.00	12.50	9.00

Split System Heat Pumps

# Split System Heat Pumps Summary of System Ratings

**IMPORTANT:**

This table is intended as an at-a-glance overview. See AHRI for complete and up-to-date indoor and outdoor system ratings by model. Not all matches will attain ratings shown below.

<b>Gold 17- 2 Stage</b>		<b>Gold 17 - Two Stage 17 SEER Heat Pump and Air Handler Ratings Summary (up to 17.25 SEER / 13.5 EER / 9.6 HSPF)</b>																				
		1.5 Ton			2 Ton			2.5 Ton			3 Ton			3.5 Ton			4 Ton			5 Ton		
		SEER	EER	HSPF	SEER	EER	HSPF	SEER	EER	HSPF	SEER	EER	HSPF	SEER	EER	HSPF	SEER	EER	HSPF	SEER	EER	HSPF
TEM Air Handler	TEM6				17.00	12.50	8.50				17.00	12.50	9.60				17.00	12.50	9.60	15.00	12.00	9.60
ForeFront™ Air Handlers	GAM5				16.00	12.50	9.00				16.00	12.50	9.00				16.00	12.00	9.00	15.00	11.00	9.00
	TAM7				17.00	13.00	8.50				17.00	13.00	9.00				17.00	13.00	9.50	16.00	12.50	8.50
	TAM8				17.25	13.50	9.60				17.75	13.00	9.20				17.25	12.50	9.00	16.25	12.00	9.00

<b>Platinum 18 AccuComfort™</b>		<b>Platinum 18 - SEER AccuComfort™ Variable Speed Heat Pump and Air Handler Ratings Summary (up to 18 SEER / 13.5 EER / 10.0 HSPF)</b>																				
		1.5 Ton			2 Ton			2.5 Ton			3 Ton			3.5 Ton			4 Ton			5 Ton		
		SEER	EER	HSPF	SEER	EER	HSPF	SEER	EER	HSPF	SEER	EER	HSPF	SEER	EER	HSPF	SEER	EER	HSPF	SEER	EER	HSPF
ForeFront™ Air Handler	TAM8				18.00	13.50	10.00				18.00	13.00	10.00				18.00	12.50	10.00	18.00	12.50	10.00

<b>Platinum 20 AccuComfort™</b>		<b>Platinum 20 - SEER AccuComfort™ Variable Speed Heat Pump and Air Handler Ratings Summary (up to 21.0 SEER / 13.50 EER / 10.0 HSPF)</b>																				
		1.5 Ton			2 Ton			2.5 Ton			3 Ton			3.5 Ton			4 Ton			5 Ton		
		SEER	EER	HSPF	SEER	EER	HSPF	SEER	EER	HSPF	SEER	EER	HSPF	SEER	EER	HSPF	SEER	EER	HSPF	SEER	EER	HSPF
ForeFront™ Air Handler	TAM8				19.25	13.75	10.00				21.00	13.50	10.00				19.25	12.50	10.00	19.00	12.70	10.00

# AccuComfort™ Variable Speed Cooling Single Phase – 2-5 Tons

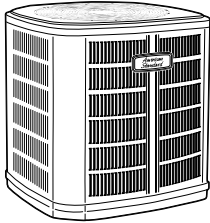

**Platinum 20  
(Variable Speed)**

**Table SH-3-A — Platinum 20 R-410A Split System Variable Speed Heat Pump (25–100% capacity)—with AccuLink™ ①**

Model Number	Power Supply	Uncrated Dimensions(in.)			Shipping Weight (lbs.)	Sound** Rating		MCA*	Max. Fuse*	Line Size (in)	
		H	W	D		(Cool)	(Heat)			OD Gas	OD Liq.
4A6V0024A1000B	208/230/1/60	41	33	30	216	54/65	60/69	17	25	5/8	3/8
4A6V0036A1000B	208/230/1/60	41	37	34	254	59/70	60/72	26	40	3/4	3/8
4A6V0048A1000B	208/230/1/60	41	37	34	266	61/74	62/76	29	45	7/8	3/8
4A6V0060A1000B	208/230/1/60	45	37	34	276	57/73	61/74	37	50	1 1/8	3/8

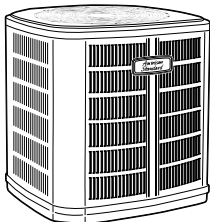

**Platinum 18  
(Variable Speed)**

**Table SH-3-B — Platinum 18 R-410A Split System Variable Speed Heat Pump (25–100% capacity)—with AccuLink™ ①**

Model Number	Power Supply	Uncrated Dimensions(in.)			Shipping Weight (lbs.)	Sound** Rating		MCA*	Max. Fuse*	Line Size (in)	
		H	W	D		(Cool)	(Heat)			OD Gas	OD Liq.
4A6V8024A1000B	208/230/1/60	41	33	30	216	54/65	60/69	17	25	5/8	3/8
4A6V8036A1000B	208/230/1/60	41	33	30	229	56/70	60/74	25	35	3/4	3/8
4A6V8037A1000B	208/230/1/60	41	37	34	254	56/70	60/74	26	40	3/4	3/8
4A6V8048A1000B	208/230/1/60	41	37	34	259	61/74	62/76	28	40	7/8	3/8
4A6V8049A1000B	208/230/1/60	41	37	34	266	61/74	62/76	29	45	7/8	3/8
4A6V8060A1000B	208/230/1/60	45	37	34	276	57/73	61/74	37	50	1 1/8	3/8

① Must use ACONT850 or AZONE950 control.

\* Information subject to change. Please confirm with current Product Data/Service Facts for current factory production.

\*\* Rated in accordance with AHRI Standard 270-2008 (Min/Max when applicable).

# AccuComfort™ Variable Speed Cooling Single Phase – 2-5 Tons

Table SH-4-A — Features	Platinum 20 (4A6V0)	Platinum 18 (4A6V8)
• SEER up to .....	21.00	18.00
• HSPF up to .....	10.00	10.00
• <b>Duration™</b> compressor .....	1	1
• Number of stages .....	Variable	Variable
• <b>Comfort-R™</b> mode approved .....	✓	✓
• <b>AccuLink™</b> system .....	✓	✓
• <b>DuraBase™</b> base, fast complete drain, weatherproof .....	✓	✓
• <b>Easy-Sess™</b> cabinet, service access & refrigerant connections with full coil protection .....	✓	✓
• <b>Spine Fin™</b> coil .....	✓	✓
• Compressor sound enclosure .....	✓	✓
• Compressor sump heat .....	✓	✓
• Factory supplied charge .....	R-410A	R-410A
• Glossy corrosion resistant finish .....	✓	✓
• High pressure switch .....	✓	✓
• Low pressure protection .....	✓	✓
• Internal high / low pressure & temperature protection .....	✓	✓
• Liquid line filter drier - factory installed or factory supplied for field install .....	✓	✓
• Start kit-factory installed .....	NA	NA
• Seacoast shield - factory installed .....	✓	—
• Tarpaulin gray cabinet .....	✓	✓
• <b>12-year registered limited warranty on compressor, 10-year on outdoor coil &amp; all other functional parts (Residential Use)①</b> .....	✓	✓
• <b>Extended warranties available</b> .....	✓	✓

**Table SH-4-B — Optional Accessories**

Model Number	Description	Shipping Weight		
BAYECMT023	Extreme Conditions Mounting Kit (Base 2/3) .....	2 .....	2	024-036
BAYECMT004	Extreme Conditions Mounting Kit (Base 4) .....	2 .....	3-5	037-060
BAYISLT101	Rubber Isolators .....	1 .....	✓	✓
BAYLEGS002	Snow Legs - Base and Cap 6" High (Black) .....	1 .....	✓	✓
BAYLEGS003	4" Extension (Black) .....	1 .....	✓	✓
BAYSEAC001	Seacoast Kit .....	1 .....	—	✓
PAI00309②	Heresite Spraypaint .....	1 .....	✓	✓

**Comfort Controls — See Comfort Controls/Zone Sensors Section**

① Registered Limited Warranty terms are available when you register within 60 days of installation. You can register online at [americanstandardair.com](http://americanstandardair.com) or by phone at 800-554-8005; otherwise American Standard Heating & Air Conditioning's Base Limited Warranty terms will apply. Base Limited Warranty information on specific products can be found on [ASDealerNet.com](http://ASDealerNet.com).

② Used for additional seacoast corrosion protection. Refer to bulletin number UN-SVB11A-EN for application information.

Split System Heat Pumps

# Split System Heat Pumps Single Phase – 1½-5 Tons

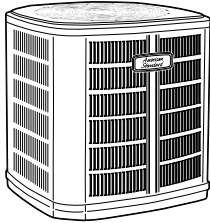

**Gold 17  
(Two Stage)**

**Table SH-5-A — Gold 17 R-410A Split System Two Stage Heat Pump (70/100% capacity)**

Model Number	Power Supply	Nom. Cap. Cooling (BTUH)	Uncrated Dimensions(in.)			Shipping Weight (lbs.)	Sound** Rating	MCA*	Max. Fuse*	Line Size (in)	
			H	W	D					OD Gas	OD Liq.
4A6H7024A1000C	208/230/1/60	24,000	41	37	34	272	72	15	25	5/8	3/8
4A6H7036B1000C	208/230/1/60	36,000	41	37	34	274	72	20	35	3/4	3/8
4A6H7048A1000C	208/230/1/60	48,000	45	37	34	329	73	28	45	7/8	3/8
4A6H7060A1000C	208/230/1/60	60,000	45	37	34	330	74	41	60	1 1/8	3/8

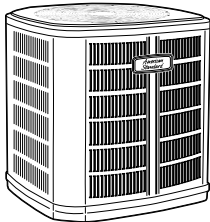

**Silver 16  
(Single Stage)**

**Table SH-5-B — Silver 16 R-410A Split System Single Stage Heat Pump**

Model Number	Power Supply	Nom. Cap. Cooling (BTUH)	Uncrated Dimensions(in.)			Shipping Weight (lbs.)	Sound** Rating	MCA*	Max. Fuse*	Line Size (in)	
			H	W	D					OD Gas	OD Liq.
<b>COMING SOON — Q2 2016</b>											
4A6H6024H1000A	208/230/1/60	24,200	33	33	30	208	71	14	25	3/4	3/8
4A6H6030H1000A	208/230/1/60	28,600	37	37	34	245	70	17	25	3/4	3/8
4A6H6036H1000A	208/230/1/60	34,800	37	37	34	246	70	18	30	7/8	3/8
4A6H6042H1000A	208/230/1/60	41,000	45	37	34	277	72	22	35	7/8	3/8
4A6H6048H1000A	208/230/1/60	47,000	45	37	34	300	72	26	40	7/8	3/8
4A6H6060H1000A	208/230/1/60	55,000	45	37	34	301	72	31	50	1 1/8	3/8

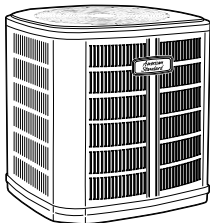

**Silver 15  
(Single Stage)**

**Table SH-5-C — Silver 15 R-410A Split System Single Stage Heat Pump**

Model Number	Power Supply	Nom. Cap. Cooling (BTUH)	Uncrated Dimensions(in.)			Shipping Weight (lbs.)	Sound** Rating	MCA*	Max. Fuse*	Line Size (in)	
			H	W	D					OD Gas	OD Liq.
4A6H5018G1000C	208/230/1/60	18,000	29	33	30	204	75	9	15	5/8	3/8
4A6H5024G1000C	208/230/1/60	24,000	33	33	30	236	75	11	15	5/8	3/8
4A6H5030G1000C	208/230/1/60	30,000	33	37	34	273	75	15	25	3/4	3/8
4A6H5036G1000C	208/230/1/60	36,000	33	37	34	261	75	17	30	3/4	3/8
4A6H5042G1000C	208/230/1/60	41,500	37	37	34	277	75	23	40	3/4	3/8
4A6H5049E1000C	208/230/1/60	48,000	45	37	34	331	75	28	50	7/8	3/8
4A6H5061E1000C	208/230/1/60	60,000	45	37	34	332	75	34	60	1 1/8	3/8

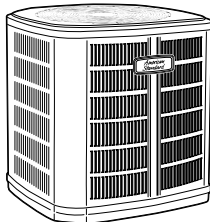

**Silver 14  
(Single Stage)**

**Table SH-5-D — Silver 14 R-410A Split System Single Stage Heat Pump**

Model Number	Power Supply	Nom. Cap. Cooling (BTUH)	Uncrated Dimensions(in.)			Shipping Weight (lbs.)	Sound** Rating	MCA*	Max. Fuse*	Line Size (in)	
			H	W	D					OD Gas	OD Liq.
4A6H4018D1000A	208/230/1/60	17,600	29	33	30	204	76	9	15	5/8	3/8
4A6H4024E1000B	208/230/1/60	23,600	33	33	30	208	76	14	25	3/4	3/8
4A6H4030D1000A	208/230/1/60	28,200	33	37	34	273	76	15	25	3/4	3/8
4A6H4036D1000A	208/230/1/60	34,000	33	37	34	229	76	22	35	3/4	3/8
4A6H4042D1000A	208/230/1/60	41,000	33	37	34	253	76	26	45	3/4	3/8
4A6H4048D1000A	208/230/1/60	46,500	37	37	34	269	76	28	50	7/8	3/8
4A6H4060E1000B	208/230/1/60	56,000	45	37	34	301	76	32	50	1 1/8	3/8

\* Information subject to change. Please confirm with current Product Data/Service Facts for current factory production.  
\*\* Rated in accordance with AHRI Standard 270-2008.

Split System Heat Pumps

# Split System Heat Pumps Single Phase – 1½-5 Tons

**Table SH-6-A — Features**

	Gold 17 (4A6H7)	Silver 16 (4A6H6)	Silver 15 (4A6H5)	Silver 14 (4A6H4)
• SEER up to .....	17.25	17.00	15.00	14.50
• HSPF up to .....	9.60	9.60	9.50	8.50
• <b>Duration™</b> compressor .....	1	1	1	1
• Number of stages .....	2	1	1	1
• <b>Comfort-R™</b> mode approved .....	✓	✓	✓	✓
• <b>DuraBase™</b> base, fast complete drain, weatherproof .....	✓	✓	✓	✓
• <b>Easy-Sess™</b> cabinet, service access & refrigerant connections with full coil protection .....	✓	✓	✓	✓
• <b>Spine Fin™</b> coil .....	✓	✓	✓	✓
• Demand Defrost Control w/ <b>Lite Port™</b> /Stored Diagnostics .....	—	—	✓	✓
• Electronic Expansion Valve (EEV) .....	✓	—	—	—
• Compressor sound enclosure .....	—	—	2½-3½	2½
• Compressor sump heat - factory installed .....	✓	—	✓	5
• Factory supplied charge .....	R-410A	R-410A	R-410A	R-410A
• Glossy corrosion resistant finish .....	✓	✓	✓	✓
• High pressure switch .....	✓	✓	✓	✓
• Low pressure switch .....	✓	✓	—	✓
• Liquid line filter drier - factory supplied or installed .....	✓	✓	✓	✓
• Quick start kit - factory installed .....	—	1½-2	1½-3,5	1½-2½
• Seacoast shield - factory installed .....	✓	—	✓	—
• Spinnaker gray cabinet .....	✓	✓	✓	✓
• <b>12-year registered limited warranty on compressor, 10-year on outdoor coil &amp; all other functional parts (Residential Use)①</b> .....	✓	—	—	—
• <b>10-year registered limited warranty on compressor, outdoor coil &amp; all other functional parts (Residential Use)①</b> .....	—	✓	✓	✓
• <b>Extended warranties available</b> .....	✓	✓	✓	✓

**Table SH-6-B — Optional Accessories**

Model Number	Description	Shipping Weight				
AY28X084.....	Evaporator Defrost Control .....	1	—	—	✓	✓
BAYCCHT300RES.....	Crankcase Heater Kit (Reciprocating).....	1	—	—	—	1½-2½
BAYCCHT301RES.....	Crankcase Heater Kit (Scroll).....	1	—	3½-5	—	3½-4
BAYCCHT302RES.....	Crankcase Heater Kit (Scroll).....	1	—	2-3	2	2,3
BAYECMT023.....	Extreme Conditions Mounting Kit (Base 2/3).....	2	—	2	2	1½-2
BAYECMT004.....	Extreme Conditions Mounting Kit (Base 4).....	2	✓	2½-5	✓	2½-5
BAYISLT101.....	Rubber Isolators.....	1	✓	✓	✓	✓
BAYKSKT263.....	Start kit (Scroll) .....	1	2-3	2½-5	3½-4	2,3-5
BAYKSKT266.....	Start kit (Scroll) .....	1	4-5	—	—	—
BAYLEGS002.....	Snow Legs - Base and Cap 6" High (Black) .....	1	✓	✓	✓	✓
BAYLEGS003.....	4" extension (Black) .....	1	✓	✓	✓	✓
BAYLOAM103.....	Low Ambient Kit .....	1	—	—	✓④	✓
BAYLOAM107.....	Low Ambient Kit .....	1	—	✓	—	—
TAYASCT501A②③.....	Anti-Short Cycle Timer .....	2	✓	✓	✓	✓
BAYSDEN001.....	Single Cylinder Compressor Enclosures .....	8	—	—	1½	1½, 2½
BAYSDEN003.....	Small Scroll Compressor Enclosures.....	8	2-3	2-3	2	2-3
BAYSDEN004.....	Large Scroll Compressor Enclosures .....	8	4-5	3½-5	4-5	3½-4
AAYSVPANL0032AA.....	Service Valve Panel Cover Kit .....	2	—	—	1½	1½
AAYSVPANL3343AA.....	Service Valve Panel Cover Kit .....	2	2-3	2	2-3	2-3½
AAYSVPANL0044AA.....	Service Valve Panel Cover Kit .....	2	4-5	2½-3	3½-4	4
AAYSVPANL0046AA.....	Service Valve Panel Cover Kit .....	2	—	3½-5	5	5
TAYPLUS103A.....	Heat Pump Control Kit .....	3	—	—	✓	✓
PAI00309⑤.....	Heresite Spraypaint.....	1	✓	✓	✓	✓

**Comfort Controls — See Comfort Controls/Zone Sensors Section**

- ① Registered Limited Warranty terms are available when you register within 60 days of installation. You can register online at americanstandardair.com or by phone at 800-554-8005; otherwise American Standard Heating & Air Conditioning's Base Limited Warranty terms will apply. Base Limited Warranty information on specific products can be found on ASDealerNet.com.
- ② Do not use with programmable thermostats.
- ③ Activated on Power Off.
- ④ For operation to 20°F outdoor ambient.
- ⑤ Used for additional seacoast corrosion protection. Refer to bulletin number UN-SVB11A-EN for application information.

For complete equipment / combination selections, installation instructions and warranty information, please refer to Product Data/Ratings and/or Installers Guides and Limited Warranty Handbooks.

# Split System Heat Pumps Single Phase and Three Phase

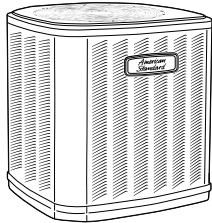

**Silver SI - 4TWB3  
(Single Stage)**

**Table SH-7-A — Silver SI R-410A Split System Single Stage Heat Pump**

Model Number	Power Supply	Nom. Cap. Cooling (BTUH)	Uncrated Dimensions(in.)			Shipping Weight (lbs.)	Sound** Rating	MCA*	Max. Fuse*	Line Size (in)	
			H	W	D					OD Gas	OD Liq.
4TWB3018D1000A	208/230/1/60	17,000	29	33	30	184	76	12	20	5/8	3/8
4TWB3024D1000A	208/230/1/60	23,000	29	33	30	184	76	17	25	5/8	3/8
4TWB3030C1000A	208/230/1/60	28,500	33	33	30	221	79	15	25	3/4	3/8
4TWB3036C1000A	208/230/1/60	34,500	33	37	34	229	76	22	35	3/4	3/8
4TWB3042B1000C	208/230/1/60	40,500	33	37	34	253	79	26	45	3/4	3/8
4TWB3048B1000C	208/230/1/60	46,500	37	37	34	269	78	28	50	7/8	3/8
4TWB3060B1000C	208/230/1/60	58,500	41	37	34	284	78	34	60	7/8	3/8

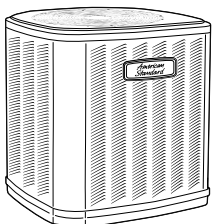

**Silver - 4TWA3  
(Single Stage)**

**Table SH-7-A — Silver 3-Phase R-410A Split System Single Stage Heat Pump - Three Phase**

Model Number	Power Supply	Nom. Cap. Cooling (BTUH)	Uncrated Dimensions(in.)			Shipping Weight (lbs.)	Sound** Rating	MCA*	Max. Fuse*	Line Size (in)	
			H	W	D					Gas	Liq.
4TWA3030A3000C	208/230/3/60	30,000	37	33	30	233	80	11	15	3/4	3/8
4TWA3036A3000C	208/230/3/60	36,000	33	37	34	228	79	14	20	3/4	3/8
4TWA3042B3000A	208/230/3/60	40,500	33	37	34	248	80	18	30	3/4	3/8
4TWA3048B3000A	208/230/3/60	46,500	41	37	34	279	78	18	30	7/8	3/8
4TWA3060B3000A	208/230/3/60	58,500	41	37	34	280	78	20	35	7/8	3/8
4TWA3030A4000C	460/3/60	30,000	37	33	30	231	80	5	15	3/4	3/8
4TWA3036A4000C	460/3/60	36,000	33	37	34	228	79	8	15	3/4	3/8
4TWA3042B4000A	460/3/60	40,500	33	37	34	248	80	8	15	3/4	3/8
4TWA3048A4000A	460/3/60	46,500	41	37	34	278	78	8	15	7/8	3/8
4TWA3060B4000A	460/3/60	58,500	41	37	34	280	78	10	15	7/8	3/8

\* Information subject to change. Please confirm with current Product Data/Service Facts for current factory production.

\*\* Rated in accordance with AHRI Standard 270-2008.

# Split System Heat Pumps Single Phase and Three Phase

**Table SH-8-A — Features**

	4TWB3	4TWA3
• SEER up to .....	14.00	13.00
• HSPF up to .....	8.50	8.50
• <b>Comfort-R™</b> mode approved.....	✓	✓
• <b>DuraBase™</b> base, fast complete drain, weatherproof .....	✓	✓
• <b>Easy-Sess™</b> cabinet, service access & refrigerant connections with full coil protection .....	✓	✓
• <b>Spine Fin™</b> coil .....	✓	✓
• Compressor sump heat - factory installed .....	✓	✓
• Refrigerant .....	R-410A	R-410A
• Glossy corrosion resistant finish .....	✓	✓
• High pressure switch .....	✓	✓
• Low pressure switch.....	✓	✓
• Liquid line filter drier - factory installed or field supplied .....	✓	✓
• Polyslate gray cabinet .....	✓	✓
• Start kit - factory installed.....	2½	—
• <b>10-year registered limited warranty on compressor, outdoor coil &amp; all other functional parts (Residential Use)①</b> .....	✓	—
• <b>5-year basic limited warranty on compressor, 1-year on outdoor coil &amp; all other functional parts (Commercial Use)</b> .....	✓	✓
• <b>5-year registered limited warranty on compressor, outdoor coil &amp; 5-year on all other functional parts (Residential Use)</b> .....	✓	✓
• <b>Extended warranties available</b> .....	✓	✓

**Table SH-8-B — Optional Accessories**

Model Number	Description	Shipping Weight		
AY28X084.....	Evaporator Defrost Control HP .....	1	✓	✓
BAYCCHT300RES.....	Crankcase Heater Kit (Recip) .....	1	2½	—
BAYCCHT301RES.....	Crankcase Heater Kit (Scroll).....	1	3½-5	5
BAYCCHT302RES.....	Crankcase Heater Kit (Scroll).....	1	1½,2,3	1½-4
BAYECMT023 .....	Extreme Conditions Mounting Kit (Base 2/3) .....	2	1½-2½	2½
BAYECMT004 .....	Extreme Conditions Mounting Kit (Base 4) .....	2	3-5	3-5
BAYISLT101 .....	Rubber Isolators.....	1	✓	✓
BAYKSKT263 .....	Start Kit (Scroll) .....	1	1½-2,3-5	✓
BAYLEGS002 .....	Snow Legs - Base and Cap 6" High (Black) .....	1	✓	✓
BAYLEGS003 .....	4" Extension (Black).....	1	✓	✓
BAYLOAM103 .....	Low Ambient Kit .....	1	✓	✓
BAYSDEN003 .....	Small Scroll Compressor Enclosures.....	8	1½-4	1½-4
BAYSDEN004 .....	Large Scroll Compressor Enclosures .....	8	5	5
BAYSEAC001.....	Seacoast Kit .....	1	✓	✓
TAYASCT501A②③ .....	Anti-short cycle timer .....	2	✓	✓
PAI00309④.....	Heresite Spraypaint.....	1	✓	✓

**Comfort Controls — See Comfort Controls/Zone Sensors Section**

- ① Registered Limited Warranty terms are available when you register within 60 days of installation. You can register online at americanstandardair.com or by phone at 800-554-8005; otherwise American Standard Heating & Air Conditioning's Base Limited Warranty terms will apply. Base Limited Warranty information on specific products can be found on ASDealerNet.com.
- ② Do not use with programmable thermostats.
- ③ Activated on Power Off.
- ④ Used for additional seacoast corrosion protection. Refer to bulletin number UN-SVB11A-EN for application information.



# Multi-position Air Handler

\* **Note: No internal modifications required for any position.**  
 ① Badge rotation will keep brand in correct position

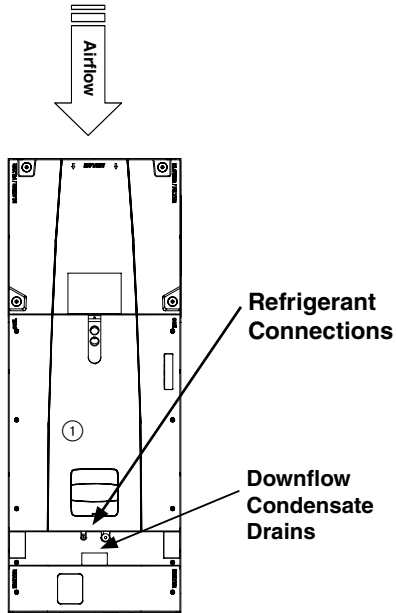

**Vertical Downflow\***

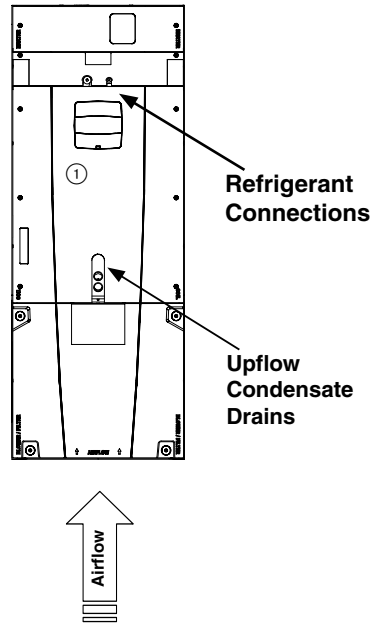

**Vertical Upflow\*  
(as shipped)**

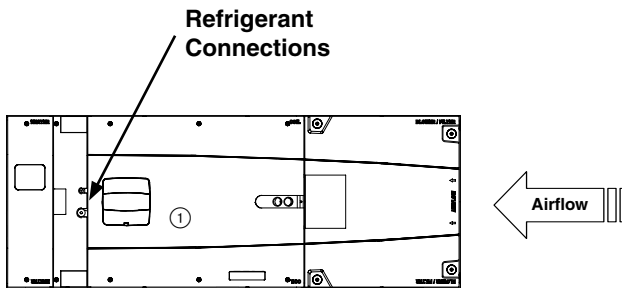

**Horizontal Left\***

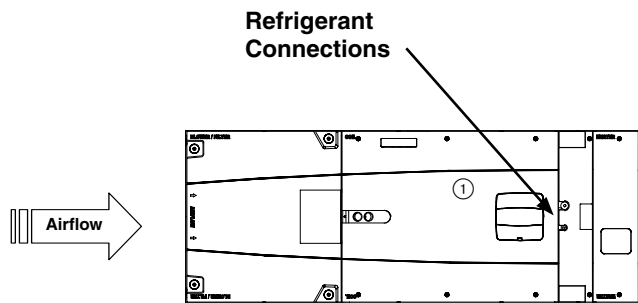

**Horizontal Right\***

# Features and Benefits

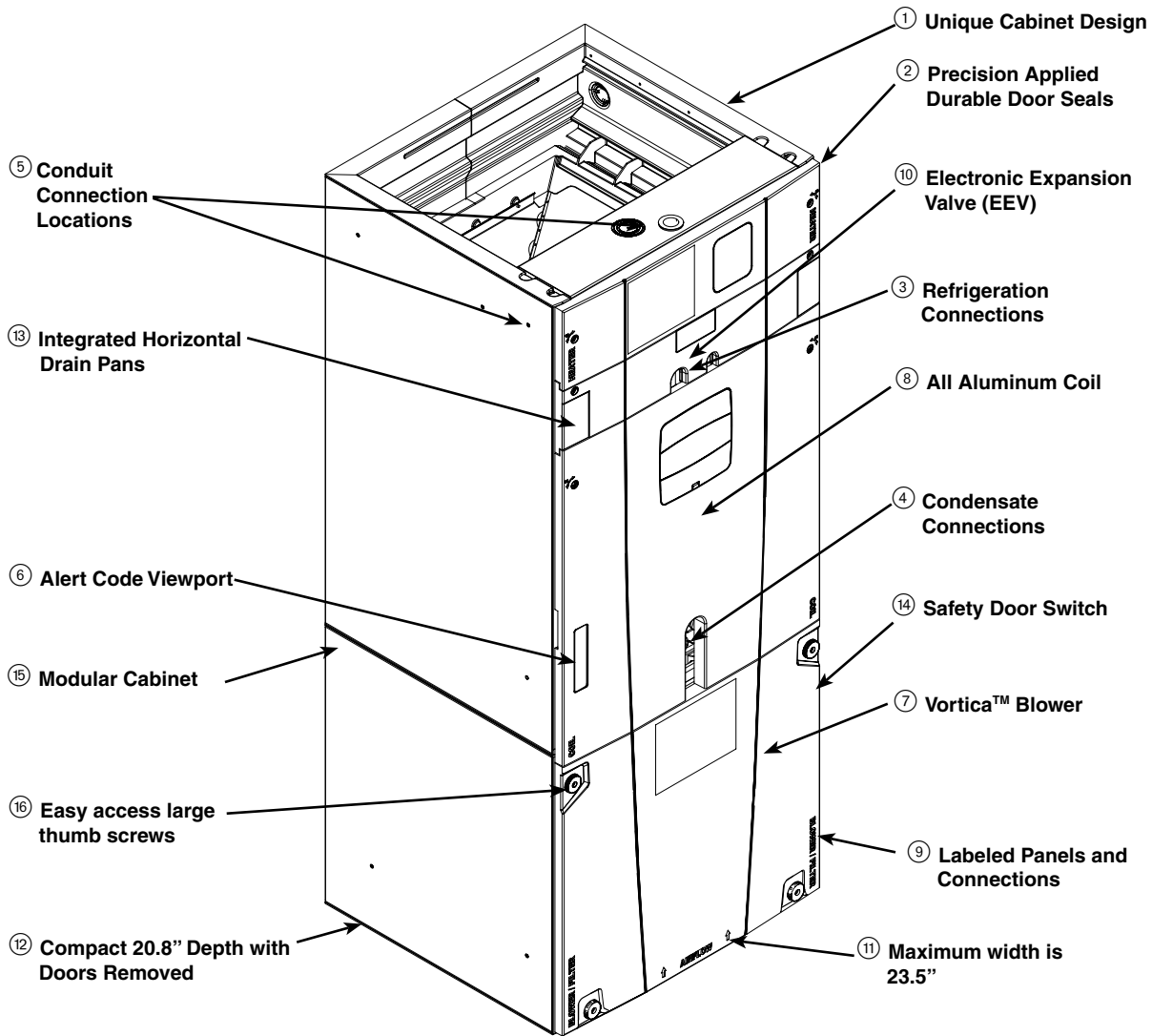

**① Unique Cabinet Design**

- Double wall foamed cabinet system
- Waterproof Cabinet Design (No Thermal Breakage)
- $\geq$  R-4.2 Insulating Value (Avg. Insulating Value R-8.2)
- Composite Cabinet Doors
- Sweat Eliminating Cabinet Design
- Loose Fiber Eliminating Design
- Smooth Cleanable Cabinet Design

**② Precision Applied Durable Door Seals**

**③ Refrigeration Connections**

**④ Condensate Connections**

**⑤ Conduit Connection Locations** - Dimples in cabinet mark Conduit Connection Locations for Left, Right, and Top

**⑥ Alert Code Viewport**

- Alert Codes can be Viewed Without Door Removal
- Control Protection Pocket

**⑦ Vortica™ Blower**

- Polarized Plug Connections
- Integrated Slide Deck for Easy Removal

**⑧ All Aluminum Coil**

- Integrated Slide Deck for Easy Removal
- Polarized Plug connections on Coil EEV
- Patented Enhanced Coil Fin

**⑨ Labeled Panels and Connections**

**⑩ Electronic Expansion Valve (EEV)**

- Low Ambient and Low Superheat Compressor Protection
- Dual Refrigerant Compatible as Shipped

**⑪ Maximum width is 23.5"**

**⑫ Compact 20.8" Depth with Doors Removed**

**⑬ Integrated Horizontal Drain Pans**

**⑭ Safety Door Switch** - Fused 24V Power

**⑮ Modular Cabinet**

**⑯ Easy access large thumb screws**

# Series 8 Variable Speed Multi-Position Air Handlers 2-5 Tons

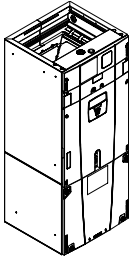

**Table AH-3-A — AccuLink™ Variable Speed R-410A with Smart Fan Options 200-230/1/60, Standard Coil**

Unit Model No.	Cooling Capacity (Btuh)	Dimensions (in.) H x W x D	Shipping Weight (lbs.)	Supply Opening	Return Opening	Filter Sizes	Line Size Gas	Line Size Liquid
TAM8C0A24V21CB	24000	49.9 x 17.5 x 21.8	126	14.5 x 14.35	14.5 x 17.15	16 x 20 x 1	3/4	3/8
TAM8C0B30V21CB	30000	55.7 x 21.3 x 21.8	150	18.4 x 14.35	18.4 x 17.15	20 x 20 x 1	3/4	3/8
TAM8C0C36V31CB	36000	56.9 x 23.5 x 21.8	157	20.5 x 14.35	20.5 x 17.15	22 x 20 x 1	7/8	3/8
TAM8C0C42V31CB	42000	56.9 x 23.5 x 21.8	162	20.5 x 14.35	20.5 x 17.15	22 x 20 x 1	7/8	3/8
TAM8C0C48V41CB	48000	61.7 x 23.5 x 21.8	174	20.5 x 14.35	20.5 x 17.15	22 x 20 x 1	7/8	3/8
TAM8C0C60V51CB	60000	61.7 x 23.5 x 21.8	175	20.5 x 14.35	20.5 x 17.15	22 x 20 x 1	7/8	3/8

**Table AH-3-B — AccuLink™ Variable Speed R-410A with Smart Fan Options 200-230/1/60, Black Epoxy Coil**

Unit Model No.	Cooling Capacity (Btuh)	Dimensions (in.) H x W x D	Shipping Weight (lbs.)	Supply Opening	Return Opening	Filter Sizes	Line Size Gas	Line Size Liquid
TAM8C0A24V21EA	24000	49.9 x 17.5 x 21.8	126	14.5 x 14.35	14.5 x 17.15	16 x 20 x 1	3/4	3/8
TAM8C0B30V21EA	30000	55.7 x 21.3 x 21.8	150	18.4 x 14.35	18.4 x 17.15	20 x 20 x 1	3/4	3/8
TAM8C0C36V31EA	36000	56.9 x 23.5 x 21.8	157	20.5 x 14.35	20.5 x 17.15	22 x 20 x 1	7/8	3/8
TAM8C0C42V31EA	42000	56.9 x 23.5 x 21.8	162	20.5 x 14.35	20.5 x 17.15	22 x 20 x 1	7/8	3/8
TAM8C0C48V41EA	48000	61.7 x 23.5 x 21.8	174	20.5 x 14.35	20.5 x 17.15	22 x 20 x 1	7/8	3/8
TAM8C0C60V51EA	60000	61.7 x 23.5 x 21.8	175	20.5 x 14.35	20.5 x 17.15	22 x 20 x 1	7/8	3/8

# Series 7 Variable Speed Multi-Position Air Handlers 2-5 Tons

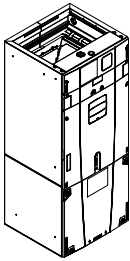

**Table AH-3-C — Variable Speed R-410A with Comfort-R™ Enhanced Mode Option 200-230/1/60, Standard Coil**

Unit Model No.	Cooling Capacity (Btuh)	Dimensions (in.) H x W x D	Shipping Weight (lbs.)	Supply Opening	Return Opening	Filter Sizes	Line Size Gas	Line Size Liquid
TAM7A0A24H21SD	24000	49.9 x 17.5 x 21.8	126	14.5 x 14.35	14.5 x 17.15	16 x 20 x 1	3/4	3/8
TAM7A0B30H21SD	30000	55.7 x 21.3 x 21.8	150	18.4 x 14.35	18.4 x 17.15	20 x 20 x 1	3/4	3/8
TAM7A0C36H31SD	36000	56.9 x 23.5 x 21.8	157	20.5 x 14.35	20.5 x 17.15	22 x 20 x 1	7/8	3/8
TAM7A0C42H31SD	42000	56.9 x 23.5 x 21.8	162	20.5 x 14.35	20.5 x 17.15	22 x 20 x 1	7/8	3/8
TAM7A0C48H41SD	48000	61.7 x 23.5 x 21.8	174	20.5 x 14.35	20.5 x 17.15	22 x 20 x 1	7/8	3/8
TAM7B0C60H51SC	60000	61.7 x 23.5 x 21.8	175	20.5 x 14.35	20.5 x 17.15	22 x 20 x 1	7/8	3/8

**Table AH-3-D — Variable Speed R-410A with Comfort-R™ Enhanced Mode Option 200-230/1/60, Black Epoxy Coil**

Unit Model No.	Cooling Capacity (Btuh)	Dimensions (in.) H x W x D	Shipping Weight (lbs.)	Supply Opening	Return Opening	Filter Sizes	Line Size Gas	Line Size Liquid
TAM7A0A24H21EA	24000	49.9 x 17.5 x 21.8	126	14.5 x 14.35	14.5 x 17.15	16 x 20 x 1	3/4	3/8
TAM7A0B30H21EA	30000	55.7 x 21.3 x 21.8	150	18.4 x 14.35	18.4 x 17.15	20 x 20 x 1	3/4	3/8
TAM7A0C36H31EA	36000	56.9 x 23.5 x 21.8	157	20.5 x 14.35	20.5 x 17.15	22 x 20 x 1	7/8	3/8
TAM7A0C42H31EA	42000	56.9 x 23.5 x 21.8	162	20.5 x 14.35	20.5 x 17.15	22 x 20 x 1	7/8	3/8
TAM7A0C48H41EA	48000	61.7 x 23.5 x 21.8	174	20.5 x 14.35	20.5 x 17.15	22 x 20 x 1	7/8	3/8
TAM7B0C60H51EA	60000	61.7 x 23.5 x 21.8	175	20.5 x 14.35	20.5 x 17.15	22 x 20 x 1	7/8	3/8

# Series 7 & 8 Variable Speed Multi-Position Air-Tite™ Air Handlers

**Table AH-4-A — Features**

	TAM7 2-5	TAM8 2-5
• Unique cabinet design .....	✓	✓
– 2% or less air leakage .....	✓	✓
– Precision applied - durable door seals .....	✓	✓
– Specially designed air seal around refrigerant, condensate and conduit connections .....	✓	✓
– Double wall foamed cabinet system .....	✓	✓
– ≥ R-4.2 insulating value (Avg. Insulating Value R-8.2) .....	✓	✓
– No loose fiber design .....	✓	✓
– Smooth cleanable interior design .....	✓	✓
– Sweat eliminating design .....	✓	✓
– Composite cabinet doors .....	✓	✓
– Water proof cabinet design .....	✓	✓
– Integrated horizontal drain pans .....	✓	✓
– Modular cabinet .....	✓	✓
• Multi-position up/down flow horizontal left/right .....	✓	✓
• Side return option (sold as accessory) .....	✓	✓
• Control board protection pocket built into cabinet wall .....	✓	✓
• Alert port to view control board codes without door removal .....	✓	✓
• <b>AccuLink™</b> control .....	✓	✓
• Alert code notification .....	✓	✓
• 5 button user interface and clear description of set up .....	—	✓
• Service diagnostic with alert reported at user interface .....	—	✓
• Low voltage terminal connection point .....	✓	✓
• <b>Vortica®</b> blower with polarized plug connections and integrated slide deck for easy removal .....	✓	✓
• Aluminum coil with integrated slide deck for easy removal and polarized plug connections on coil EEV .....	✓	✓
• Patented enhanced coil fin .....	✓	✓
• Electronic Expansion Valve (EEV) with low ambient and low superheat compressor protection .....	✓	✓
• Dual refrigerant compatible as shipped .....	✓	✓
• Slide in electric heaters with polarized plug connections (sold as accessory) .....	✓	✓
• Slide in hot water coils with polarized plug connections (sold as accessory) .....	✓	✓
• UVC light kit with safety switch and polarized plug connections (sold as accessory) .....	✓	✓
• Labeled panels and connections .....	✓	✓
• Molded in 1" standard filter rail .....	✓	✓
• Variable speed ECM motor .....	✓	✓
• Soft start fan motor operation .....	✓	✓
• <b>Comfort R™</b> mode .....	✓	✓
• Built in fan delay modes .....	✓	✓
• Maximum width of 23.5" .....	✓	✓
• Compact 20.8" depth with doors removed .....	✓	✓
• Fused 24v power .....	✓	✓
• Safety door switch .....	✓	✓
• <b>10-year warranty registered</b> .....	✓	✓
• <b>Optional extended warranty available</b> .....	✓	✓

# Series 7 & 8 Variable Speed Multi-Position Air-Tite™ Air Handlers

**Table AH-5-A — Optional Accessories**

Model Number	Description	Matches Cabinet Size(s) <sup>①</sup>	TAM7	TAM8
BAYCC24VK01A	Compressor Module Kit		—	✓
BAYWVAA05SC1AA	Hydronic Heater, 40,000 BTUH, Nominal, Slide-in, RS-485 Control <sup>③</sup>	A	✓	✓
BAYWVBB07SC1AA	Hydronic Heater, 50,000 BTUH, Nominal, Slide-in, RS-485 Control <sup>③</sup>	B	✓	✓
BAYWVCC08SC1AA	Hydronic Heater, 65,000 BTUH, Nominal, Slide-in, RS-485 Control <sup>③</sup>	C	✓	✓
BAYWACC11SC1AA	Hydronic Heater, 100,000 BTUH, Nominal, External, No Control <sup>③</sup>	C	✓	✓
BAYWVBRD485	RS-485 Control for BAYWACC11SC1AA	C	✓	✓
BAYSUPFLGAA	Supply Duct Flange A	A	✓	✓
BAYSUPFLGBA	Supply Duct Flange B	B	✓	✓
BAYSUPFLGCA	Supply Duct Flange C	C	✓	✓
BAYRETFLGAA	Return Duct Flange A	A	✓	✓
BAYRETFLGBA	Return Duct Flange B	B	✓	✓
BAYRETFLGCA	Return Duct Flange C	C	✓	✓
BAYFLR1620A	Washable high velocity filter, 16" x 20" x 1" (10 filters)	A	✓	✓
BAYFLR2020A	Washable high velocity filter, 20" x 20" x 1" (10 filters)	B	✓	✓
BAYFLR2220A	Washable high velocity filter, 22" x 20" x 1" (10 filters)	C	✓	✓
TASB175SB <sup>②⑤</sup>	Plenum Stand with Integrated Sound Baffle A	A	✓	✓
TASB215SB <sup>②⑤</sup>	Plenum Stand with Integrated Sound Baffle B	B	✓	✓
TASB235SB <sup>②⑤</sup>	Plenum Stand with Integrated Sound Baffle C	C	✓	✓
BAYSRKIT100	Side Return Kit	A-C	✓	✓
BAYFRKIT175	Front Return Kit	A	✓	✓
BAYFRKIT210	Front Return Kit	B	✓	✓
BAYFRKIT235	Front Return Kit	C	✓	✓
MTISRKIT1620 <sup>②</sup>	Side Return Kit with 16"x20" Filter	A-C	✓	✓
TASSBK175 <sup>②④⑥</sup>	Sound Baffle Kit 17.5" Cabinet	A	✓	✓
TASSBK215 <sup>②④⑥</sup>	Sound Baffle Kit 21.5" Cabinet	B	✓	✓
TASSBK235 <sup>②④⑥</sup>	Sound Baffle Kit 23.5" Cabinet	C	✓	✓
BAYSPEKT200	Single Power Entry Kit		✓	✓
BAYICKKIT01	Internal Condensate Switch Kit		✓	✓
BAYHHKIT001	Horizontal Hanger Kit		✓	✓
BAYUVCLK001	UVC Lights		✓	✓
BAYLVKIT100	Low Voltage Conduit Entry Kit		✓	✓
BAYBAFKT175A <sup>⑦</sup>	Baffle Kit 17.5" Cabinet	A	✓	✓
BAYBAFKT215A <sup>⑦</sup>	Baffle Kit 21.5" Cabinet	B	✓	✓
BAYBAFKT235A <sup>⑦</sup>	Baffle Kit 23.5" Cabinet	C	✓	✓
BAYINSKT175A	Sound Insulation Kit 17.5" Cabinet	A	✓	✓
BAYINSKT215A	Sound Insulation Kit 21.5" Cabinet	B	✓	✓
BAYINSKT235A	Sound Insulation Kit 23.5" Cabinet	C	✓	✓
BAYCNDPIP01A	3/4" PVC Threaded Pipe Kit with foam seal (10 kits)		✓	✓

① A Cabinet is 17.5" wide, B Cabinet is 21.5" wide, C Cabinet is 23.5" wide.  
 ② Contact your distributor for information.  
 ③ ACONT900 Thermostat can not be used with Hydronic heating.  
 ④ In return plenum applications, use TASSBK kits for sound reduction.  
 ⑤ In open air applications, Plenum Stand with Sound Baffle provides sound reduction.  
 ⑥ Mounts to TASB original plenum stands without integrated sound baffle.  
 ⑦ Mounts inside air filter channel on air handler.

# Series 4 Multi-Position Air Handlers Single Phase 1½-5 Tons

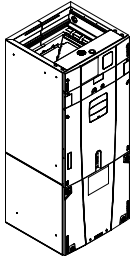

**Table AH-6-A — Multi-Speed PSC Motor 200-230/1/60**

Unit Model No.	Cooling Capacity (Btuh)	Dimensions (in.) H x W x D	Shipping Weight (lbs.)	Supply Opening	Return Opening	Filter Sizes	Line Size Gas	Line Size Liquid
TAM4A0A18S11SD	18000	49.9 x 17.5x 21.8	123	14.5 x 14.35	14.5 x 17.15	16 x 20 x 1	¾	¾
TAM4A0A24S21SD	24000	49.9 x 17.5x 21.8	126	14.5 x 14.35	14.5 x 17.15	16 x 20 x 1	¾	¾
TAM4A0A30S21SD	30000	49.9 x 17.5x 21.8	127	14.5 x 14.35	14.5 x 17.15	16 x 20 x 1	7/8	¾
TAM4A0A36S31SD	36000	49.9 x 17.5x 21.8	130	14.5 x 14.35	14.5 x 17.15	16 x 20 x 1	7/8	¾
TAM4A0B42S31SD	42000	55.7 x 21.3x 21.8	144	18.4 x 14.35	18.4 x 17.15	20 x 20 x 1	7/8	¾
TAM4A0C48S41SD	48000	56.9 x 23.5x 21.8	155	20.5 x 14.35	20.5 x 17.15	20 x 20 x 1	7/8	¾
TAM4A0C60S51SD <sup>①</sup>	60000	61.7 x 23.5x 21.8	171	20.5 x 14.35	20.5 x 17.15	22 x 20 x 1	7/8	¾

① High efficiency ECM motor.

**Table AH-6-B — Features**

	TAM4 1 1/2-5
• Unique cabinet design.....	✓
– 2% or less air leakage.....	✓
– Precision applied - durable door seals.....	✓
– Specially designed air seal around refrigerant, condensate and conduit connections.....	✓
– Double wall foamed cabinet system.....	✓
– ≥ R-4.2 insulating value (Avg. Insulating Value R-8.2).....	✓
– No loose fiber design.....	✓
– Smooth cleanable interior design.....	✓
– Sweat eliminating design.....	✓
– Composite cabinet doors.....	✓
– Water proof cabinet design.....	✓
– Integrated horizontal drain pans.....	✓
– Modular cabinet.....	✓
• Multi-position up/down flow horizontal left/right.....	✓
• Side return option (sold as accessory).....	✓
• Alert code notification.....	✓
• Low voltage pigtail connections.....	✓
• <b>Vortica</b> ® blower with polarized plug connections and integrated slide deck for easy removal.....	✓
• Aluminum coil with integrated slide deck for easy removal and polarized plug connections on coil EEV.....	✓
• Enhanced coil fin patented.....	✓
• Electronic Expansion Valve (EEV) with low ambient and low superheat compressor protection.....	✓
• Dual refrigerant compatible as shipped.....	✓
• Slide in electric heaters with polarized plug connections (sold as accessory).....	✓
• UVC light kit with safety switch and polarized plug connections (sold as accessory).....	✓
• Labeled panels and connections.....	✓
• Molded in 1" standard filter rail.....	✓
• PSC 3 speed motor.....	1½-4
• High efficiency ECM motor.....	5
• Maximum width of 23.5".....	✓
• Compact 20.8" depth with doors removed.....	✓
• Fused 24v power.....	✓
• Safety door switch.....	✓
• <b>10-year warranty registered</b> .....	✓
• <b>Optional extended warranty available</b> .....	✓

# Series 4 Multi-Position Air Handlers Single Phase 1½-5 Tons

**Table AH-7-A — Optional Accessories**

Model Number	Description	Matches Cabinet Size(s) <sup>①</sup>	TAM4
BAYSUPFLGAA	Supply Duct Flange A	A	✓
BAYSUPFLGBA	Supply Duct Flange B	B	✓
BAYSUPFLGCA	Supply Duct Flange C	C	✓
BAYRETFLGAA	Return Duct Flange A	A	✓
BAYRETFLGBA	Return Duct Flange B	B	✓
BAYRETFLGCA	Return Duct Flange C	C	✓
BAYFLR1620A	Washable high velocity filter, 16" x 20" x 1" (10 filters)	A	✓
BAYFLR2020A	Washable high velocity filter, 20" x 20" x 1" (10 filters)	B	✓
BAYFLR2220A	Washable high velocity filter, 22" x 20" x 1" (10 filters)	C	✓
TASB175SB <sup>②④</sup>	Plenum Stand with Integrated Sound Baffle A	A	✓
TASB215SB <sup>②④</sup>	Plenum Stand with Integrated Sound Baffle B	B	✓
TASB235SB <sup>②④</sup>	Plenum Stand with Integrated Sound Baffle C	C	✓
MTISRKIT1620 <sup>②</sup>	Side Return Kit with 16"x20" Filter	A-C	✓
TASSBK175 <sup>②③⑤</sup>	Sound Baffle Kit 17.5" Cabinet	A	✓
TASSBK215 <sup>②③⑤</sup>	Sound Baffle Kit 21.5" Cabinet	B	✓
TASSBK235 <sup>②③⑤</sup>	Sound Baffle Kit 23.5" Cabinet	C	✓
BAYSPEKT200	Single Power Entry Kit		✓
BAYSRKIT100	Side Return Kit	A-C	✓
BAYFRKIT175	Front Return Kit	A	✓
BAYFRKIT210	Front Return Kit	B	✓
BAYFRKIT235	Front Return Kit	C	✓
BAYICKIT01	Internal Condensate Switch Kit		✓
BAYHHKIT001	Horizontal Hanger Kit		✓
BAYUVCLK001	UVC Lights		✓
BAYLVKIT100A	Low Voltage Conduit Entry Kit		✓
BAYBAFKT175A <sup>⑥</sup>	Sound Baffle Kit 17.5" Cabinet	A	✓
BAYBAFKT215A <sup>⑥</sup>	Sound Baffle Kit 21.5" Cabinet	B	✓
BAYBAFKT235A <sup>⑥</sup>	Sound Baffle Kit 23.5" Cabinet	C	✓
BAYINSKT175A	Sound Insulation Kit 17.5" Cabinet	A	✓
BAYINSKT215A	Sound Insulation Kit 21.5" Cabinet	B	✓
BAYINSKT235A	Sound Insulation Kit 23.5" Cabinet	C	✓
BAYCNDPIP01A	¾" PVC Threaded Pipe Kit with foam seal (10 kits)		✓

① A Cabinet is 17.5" wide, B Cabinet is 21.5" wide, C Cabinet is 23.5" wide.  
 ② Contact your distributor for information.  
 ③ In return plenum applications, use TASSBK kits for sound reduction.  
 ④ In open air applications, Plenum Stand with Sound Baffle provides sound reduction.  
 ⑤ Mounts to TASB original plenum stands without integrated sound baffle.  
 ⑥ Mounts inside air filter channel on air handler.

# Series 5 Multi-Position Air Handlers Single Phase 1½-5 Tons

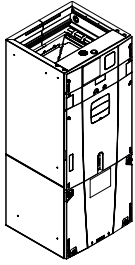

**Table AH-8-A — Multi-Speed High Efficiency Motor 200-230/1/60, Standard Coil**

Unit Model No.	Cooling Capacity (Btuh)	Dimensions (in.) H x W x D	Shipping Weight (lbs.)	Supply Opening	Return Opening	Filter Sizes	Line Size	
							Gas	Liquid
GAM5B0A18M11SB	18000	49.9 x 17.5 x 21.8	126	14.5 x 14.35	14.5 x 17.15	16 x 20 x 1	¾	⅜
GAM5B0A24M21SB	24000	49.9 x 17.5 x 21.8	126	14.5 x 14.35	14.5 x 17.15	16 x 20 x 1	¾	⅜
GAM5B0B30M21SB	30000	51.5 x 21.3 x 21.8	140	18.4 x 14.35	18.4 x 17.15	20 x 20 x 1	¾	⅜
GAM5B0B36M31SB	36000	55.7 x 21.3 x 21.8	150	18.4 x 14.35	18.4 x 17.15	20 x 20 x 1	7/8	⅜
GAM5B0C42M31SB	42000	56.9 x 23.5 x 21.8	163	20.5 x 14.35	20.5 x 17.15	22 x 20 x 1	7/8	⅜
GAM5B0C48M41SB	48000	61.7 x 23.5 x 21.8	176	20.5 x 14.35	20.5 x 17.15	22 x 20 x 1	7/8	⅜
GAM5B0C60M51SB	60000	61.7 x 23.5 x 21.8	180	20.5 x 14.35	20.5 x 17.15	22 x 20 x 1	7/8	⅜

**Table AH-8-B — Multi-Speed High Efficiency Motor 200-230/1/60, Black Epoxy Coil**

Unit Model No.	Cooling Capacity (Btuh)	Dimensions (in.) H x W x D	Shipping Weight (lbs.)	Supply Opening	Return Opening	Filter Sizes	Line Size	
							Gas	Liquid
GAM5B0A18M11EA	18000	49.9 x 17.5 x 21.8	126	14.5 x 14.35	14.5 x 17.15	16 x 20 x 1	¾	⅜
GAM5B0A24M21EA	24000	49.9 x 17.5 x 21.8	126	14.5 x 14.35	14.5 x 17.15	16 x 20 x 1	¾	⅜
GAM5B0B30M21EA	30000	51.5 x 21.3 x 21.8	140	18.4 x 14.35	18.4 x 17.15	20 x 20 x 1	¾	⅜
GAM5B0B36M31EA	36000	55.7 x 21.3 x 21.8	150	18.4 x 14.35	18.4 x 17.15	20 x 20 x 1	7/8	⅜
GAM5B0C42M31EA	42000	56.9 x 23.5 x 21.8	163	20.5 x 14.35	20.5 x 17.15	22 x 20 x 1	7/8	⅜
GAM5B0C48M41EA	48000	61.7 x 23.5 x 21.8	176	20.5 x 14.35	20.5 x 17.15	22 x 20 x 1	7/8	⅜
GAM5B0C60M51EA	60000	61.7 x 23.5 x 21.8	180	20.5 x 14.35	20.5 x 17.15	22 x 20 x 1	7/8	⅜

**Table AH-8-C — Features**

Table AH-8-C — Features	GAM5 1 1/2-5
• Unique cabinet design.....	✓
– 2% or less air leakage.....	✓
– Precision applied - durable door seals.....	✓
– Specially designed air seal around refrigerant, condensate and conduit connections.....	✓
– Double wall foamed cabinet system.....	✓
– ≥ R-4.2 insulating value (Avg. Insulating Value R-8.2).....	✓
– No loose fiber design.....	✓
– Smooth cleanable interior design.....	✓
– Sweat eliminating design.....	✓
– Composite cabinet doors.....	✓
– Water proof cabinet design.....	✓
– Integrated horizontal drain pans.....	✓
– Modular cabinet.....	✓
• Multi-position up/down flow horizontal left/right.....	✓
• Side return option (sold as accessory).....	✓
• Low voltage pigtail connections.....	✓
• <b>Vortica</b> ® blower with polarized plug connections and integrated slide deck for easy removal.....	✓
• Aluminum coil with integrated slide deck for easy removal.....	✓
• Patented enhanced coil fin.....	✓
• R-410A TXV.....	✓
• Slide in electric heaters with polarized plug connections (sold as accessory).....	✓
• UVC light kit with safety switch and polarized plug connections (sold as accessory).....	✓
• Labeled panels and connections.....	✓
• Molded in 1" standard filter rail.....	✓
• High efficiency ECM motor.....	✓
• Maximum width of 23.5".....	✓
• Compact 20.8" depth with doors removed.....	✓
• Fused 24v power.....	✓
• Safety door switch.....	✓
• <b>10-year warranty registered</b> .....	✓
• <b>Optional extended warranty available</b> .....	✓



# Series 5 Multi-Position Air Handlers Single Phase 1½-5 Tons

**Table AH-9-A — Optional Accessories**

Model Number	Description	Matches Cabinet Size(s) <sup>①</sup>	GAM5
BAYWAAA05SC1AA	Hydronic Heater, 40,000 BTUH, Nominal, Slide-in, No Control	A	✓
BAYWABB07SC1AA	Hydronic Heater, 50,000 BTUH, Nominal, Slide-in, No Control	B	✓
BAYWACC08SC1AA	Hydronic Heater, 65,000 BTUH, Nominal, Slide-in, No Control	C	✓
BAYWACC11SC1AA	Hydronic Heater, 100,000 BTUH, Nominal, Slide-in, No Control	C	✓
BAYSUPFLGAA	Supply Duct Flange A	A	✓
BAYSUPFLGBA	Supply Duct Flange B	B	✓
BAYSUPFLGCA	Supply Duct Flange C	C	✓
BAYRETFLGAA	Return Duct Flange A	A	✓
BAYRETFLGBA	Return Duct Flange B	B	✓
BAYRETFLGCA	Return Duct Flange C	C	✓
BAYFLR1620A	Washable high velocity filter, 16" x 20" x 1" (10 filters)	A	✓
BAYFLR2020A	Washable high velocity filter, 20" x 20" x 1" (10 filters)	B	✓
BAYFLR2220A	Washable high velocity filter, 22" x 20" x 1" (10 filters)	C	✓
TASB175SB <sup>②④</sup>	Plenum Stand with Integrated Sound Baffle A	A	✓
TASB215SB <sup>②④</sup>	Plenum Stand with Integrated Sound Baffle B	B	✓
TASB235SB <sup>②④</sup>	Plenum Stand with Integrated Sound Baffle C	C	✓
MTISRKIT1620 <sup>②</sup>	Side Return Kit with 16"x20" Filter	A-C	✓
TASSBK175 <sup>②③⑤</sup>	Sound Baffle Kit 17.5" Cabinet	A	✓
TASSBK215 <sup>②③⑤</sup>	Sound Baffle Kit 21.5" Cabinet	B	✓
TASSBK235 <sup>②③⑤</sup>	Sound Baffle Kit 23.5" Cabinet	C	✓
BAYSPEKT200	Single Power Entry Kit		✓
BAYSRKIT100	Side Return Kit	A-C	✓
BAYFRKIT175	Front Return Kit	A	✓
BAYFRKIT210	Front Return Kit	B	✓
BAYFRKIT235	Front Return Kit	C	✓
BAYHHKIT001	Horizontal Hanger Kit		✓
BAYUVCLK001	UVC Lights		✓
BAYLVKIT100A	Low Voltage Conduit Entry Kit		✓
BAYBAFKT175A	Baffle Kit 17.5" Cabinet	A	✓
BAYBAFKT215A	Baffle Kit 21.5" Cabinet	B	✓
BAYBAFKT235A	Baffle Kit 23.5" Cabinet	C	✓
BAYINSKT175A <sup>⑥</sup>	Sound Insulation Kit 17.5" Cabinet	A	✓
BAYINSKT215A <sup>⑥</sup>	Sound Insulation Kit 21.5" Cabinet	B	✓
BAYINSKT235A <sup>⑥</sup>	Sound Insulation Kit 23.5" Cabinet	C	✓
BAYCNDPIP01A	¾" PVC Threaded Pipe Kit with foam seal (10 kits)		✓
Model Number	Description		GAM5B
BAYATXV1836A	R-22 TXV conversion kit		1½-2
BAYATXV4248A	R-22 TXV conversion kit		2½-3½
BAYATXV6060A	R-22 TXV conversion kit		4-5

- ① A Cabinet is 17.5" wide, B Cabinet is 21.5" wide, C Cabinet is 23.5" wide.
- ② Contact your distributor for information.
- ③ In return plenum applications, use TASSBK kits for sound reduction.
- ④ In open air applications, Plenum Stand with Sound Baffle provides sound reduction.
- ⑤ Mounts to TASB original plenum stands without integrated sound baffle.
- ⑥ Mounts inside air filter channel on air handler.

# Series 2 Split System Air Handlers Single Phase 1½-5 Tons

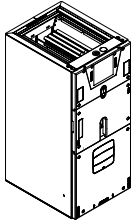

**Table AH-10-A — Multi-Speed PSC Motor 200-230/1/60**

Unit Model No.	Cooling Capacity (Btuh)	Dimensions (in.) H x W x D	Shipping Weight (lbs.)	Supply Opening	Return Opening	Filter Sizes	Line Size	
							Gas	Liquid
GAF2A0A18S11SE	18000	39.5 x 17.5 x 21.8	117	14.5 x 16.75	14.5 x 17.8	N/A	¾	⅜
GAF2A0A24S21SE	24000	39.5 x 17.5 x 21.8	120	14.5 x 16.75	14.5 x 17.8	N/A	¾	⅜
GAF2A0A30S21SE	30000	39.5 x 17.5 x 21.8	121	14.5 x 16.75	14.5 x 17.8	N/A	¾	⅜
GAF2A0A36S31SE	36000	39.5 x 17.5 x 21.8	122	14.5 x 16.75	14.5 x 17.8	N/A	¾	⅜

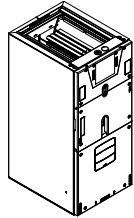

**Table AH-10-B — Multi-Speed High Efficiency ECM Motor 200-230/1/60**

Unit Model No.	Cooling Capacity (Btuh)	Dimensions (in.) H x W x D	Shipping Weight (lbs.)	Supply Opening	Return Opening	Filter Sizes	Line Size	
							Gas	Liquid
GAF2A0A36M31SC	36000	39.5 x 17.5 x 21.8	118	14.5 x 14.35	14.5 x 17.15	N/A	¾	⅜

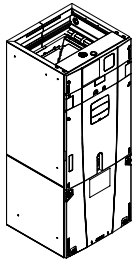

**Table AH-10-C — Multi-Speed PSC Motor 200-230/1/60**

Unit Model No.	Cooling Capacity (Btuh)	Dimensions (in.) H x W x D	Shipping Weight (lbs.)	Supply Opening	Return Opening	Filter Sizes	Line Size	
							Gas	Liquid
GAM2A0A18S11SE	18000	49.9 x 17.5 x 21.8	123	14.5 x 14.35	14.5 x 17.15	16 x 20 x 1	¾	⅜
GAM2A0A24S21SE	24000	49.9 x 17.5 x 21.8	126	14.5 x 14.35	14.5 x 17.15	16 x 20 x 1	¾	⅜
GAM2A0A30S21SE	30000	49.9 x 17.5 x 21.8	127	14.5 x 14.35	14.5 x 17.15	16 x 20 x 1	¾	⅜
GAM2A0A36S31SE	36000	49.9 x 17.5 x 21.8	131	14.5 x 14.35	14.5 x 17.15	16 x 20 x 1	¾	⅜
GAM2A0B42S31SE	42000	55.7 x 21.3 x 21.8	144	18.4 x 14.35	18.4 x 17.15	20 x 20 x 1	7/8	⅜
GAM2A0C48S41SE	48000	56.9 x 23.5 x 21.8	155	20.5 x 14.35	20.5 x 17.15	22 x 20 x 1	7/8	⅜
GAM2A0C60S51SE <sup>①</sup>	60000	61.7 x 23.5 x 21.8	171	20.5 x 14.35	20.5 x 17.15	22 x 20 x 1	7/8	⅜

① High efficiency ECM Motor

**Table AH-10-D — Features**

	GAF2 1 1/2-3	GAM2 1 1/2-5
• Unique cabinet design.....	✓	✓
– 2% or less air leakage.....	✓	✓
– Precision applied - durable door seals.....	✓	✓
– Specially designed air seal around refrigerant, condensate and conduit connections.....	✓	✓
– Double wall foamed cabinet system.....	✓	✓
– ≥ R-4.2 insulating value (Avg. Insulating Value R-8.2).....	✓	✓
– No loose fiber design.....	✓	✓
– Smooth cleanable interior design.....	✓	✓
– Sweat eliminating design.....	✓	✓
– Composite cabinet doors.....	✓	✓
– Water proof cabinet design.....	✓	✓
– Integrated horizontal drain pans.....	✓	✓
• 3 way conversion up flow/horizontal left/right.....	✓	✓
• 4 way conversion upflow/downflow/horizontal right/horizontal left.....	—	✓

# Series 2 Split System Air Handlers Single Phase 1½-5 Tons

Table AH-11-A — Features (Continued)		GAF2 1 1/2-3	GAM2 1 1/2-5
• Front return option.....		✓	✓
• Low voltage pigtail connections.....		✓	✓
• <b>Vortica</b> ® blower with polarized plug connections and integrated slide deck for easy removal.....		✓	✓
• Aluminum coil with integrated slide deck for easy removal and polarized plug connections on coil EEV (GAF2A0A36M311SA).....		3	✓
• Patented enhanced coil fin.....		✓	✓
• R-410A TXV (except GAF2A0A36M311SA).....		✓	✓
• Slide in electric heaters with polarized plug connections (sold as accessory).....		—	✓
• UVC light kit with safety switch and polarized plug connections (sold as accessory).....		—	✓
• Labeled panels and connections.....		✓	✓
• Molded in 1" standard filter rail.....		✓	✓
• PSC 3 speed motor.....		—	✓
• High efficiency constant torque ECM motor (GAF2A0A36M311SA, GAT2A0C60S51SA, and GAM2A0C60S51SA).....		3	5
• Maximum width of 23.5".....		✓	✓
• Compact 20.8" depth with doors removed.....		✓	✓
• Fused 24v power.....		✓	✓
• Safety door switch.....		—	✓
• <b>10-year warranty registered</b> .....		✓	✓
• <b>Optional extended warranty available</b> .....		✓	✓

**Table AH-11-B — Optional Accessories**

Model	Description	Matches Cabinet Size(s) ①③	GAF2	GAM2
BAYATXV1836.....	R-22 TXV conversion kit 1-1/2 to 3 ton.....		✓	✓
BAYATXV4248.....	R-22 TXV conversion kit 3-1/2 to 4 ton.....		—	✓
BAYATXV6060.....	R-22 TXV conversion kit 5 ton.....		—	✓
BAYBRFBX100.....	Bottom Return Filter Box.....		✓	—
BAYFRKIT100.....	Front Return Kit.....		✓	—
BAYHHKIT001.....	Horizontal Hanger Kit.....		✓	—
BAYICKIT01.....	Internal Condensate Switch Kit (GAF2A0A36M311SA).....		3	—
BAYLVKIT100.....	Low Voltage Conduit Entry Kit.....		✓	—
BAYRETFLGAA.....	Return Duct Flange A, A1.....	A, A1	✓	—
BAYRETFLGBA.....	Return Duct Flange B.....	B	—	—
BAYRETFLGCA.....	Return Duct Flange C.....	C	—	—
BAYSFSCABAA.....	Supply Duct Flange A1.....	A1	✓	—
BAYFLR1620A.....	Washable high velocity filter, 16" x 20" x 1" (10 filters).....	A	—	—
BAYFLR2020A.....	Washable high velocity filter, 20" x 20" x 1" (10 filters).....	B	—	—
BAYFLR2220A.....	Washable high velocity filter, 22" x 20" x 1" (10 filters).....	C	—	—
BAYSPEKT200.....	Single Power Entry Kit.....		—	—
BAYSRKIT100.....	Side Return Kit.....	A-C,A1	—	—
BAYFRKIT175.....	Front Return Kit.....	A	—	—
BAYFRKIT210.....	Front Return Kit.....	B	—	—
BAYFRKIT235.....	Front Return Kit.....	C	—	—
BAYSUPFLGAA.....	Supply Duct Flange A.....	A	—	—
BAYSUPFLGBA.....	Supply Duct Flange B.....	B	—	—
BAYSUPFLGCA.....	Supply Duct Flange C.....	C	—	—
BAYUVCLK001.....	UVC Lights.....		✓	—
BAYWMKIT001.....	Wall Mount Kit.....		✓	—
TASB175SB②④.....	Plenum Stand with Integrated Sound Baffle A.....	A	✓	—
TASB215SB②④.....	Plenum Stand with Integrated Sound Baffle B.....	B	—	—
TASB235SB②④.....	Plenum Stand with Integrated Sound Baffle C.....	C	—	—
MTISRKIT1620②.....	Side Return Kit with 16"x20" Filter.....	A-C	—	—
TASSBK175②④.....	Sound Baffle Kit 17.5" Cabinet (mounts to TASB plenum stands).....	A	✓	—
TASSBK215②④.....	Sound Baffle Kit 21.5" Cabinet (mounts to TASB plenum stands).....	B	—	—
TASSBK235②④.....	Sound Baffle Kit 23.5" Cabinet (mounts to TASB plenum stands).....	C	—	—
BAYECPDKIT1.....	Pull disconnect kit.....	A1	✓	—
BAYBAFKT175A.....	Baffle Kit 17.5" Cabinet (mounts in air handler filter channel).....	A	✓	—
BAYBAFKT215A.....	Baffle Kit 21.5" Cabinet (mounts in air handler filter channel).....	B	—	—
BAYBAFKT235A.....	Baffle Kit 23.5" Cabinet (mounts in air handler filter channel).....	C	—	—
BAYINSKT175A.....	Sound Insulation Kit 17.5" Cabinet.....	A, A1	✓	—
BAYINSKT215A.....	Sound Insulation Kit 21.5" Cabinet.....	B	—	—
BAYINSKT235A.....	Sound Insulation Kit 23.5" Cabinet.....	C	—	—
BAYCNDPIP01A.....	3/4" PVC Threaded Pipe Kit with foam seal (10 kits).....		✓	—

① A and A1 Cabinets are 17.5" wide, B Cabinet is 21.5" wide, C Cabinet is 23.5" wide. The A1 cabinet is used on the GAF2 air handlers only.

② Contact your distributor for information.

③ In return plenum applications, use TASSBK kits for sound reduction.

④ In open air applications, Plenum Stand with Sound Baffle provides sound reduction.

For complete equipment / combination selections, installation instructions and warranty information, please refer to Product Data/Ratings and/or Installers Guides and Limited Warranty Handbooks.

# Heaters for Multi-Position Air Handlers

**Table AH-12-A — BAYEA — Heater, Standard, for 4 Series, 5 Series, GAT2, and GAM2 Air Handlers**

Heater Model Number	Capacity @ 240 Volts		Capacity @ 208 Volts		Rated Voltage	Control Stages	Number of Heater Racks	Number of Circuits	Heater Amps per Circuit		Contains Circuit Breakers
	kW	BTUH	kW	BTUH					208 Volts	240Volt	
BAYEAC04BK1AA	3.84	13100	2.88	9800	208/240/1/60	1	1	1	13.8	16	Yes
BAYEAC04LG1AA	3.84	13100	2.88	9800	208/240/1/60	1	1	1	13.8	16	No
BAYEAC05BK1AB	4.80	16400	3.60	12300	208/240/1/60	1	1	1	17.3	20	Yes
BAYEAC05LG1AB	4.80	16400	3.60	12300	208/240/1/60	1	1	1	17.3	20	No
BAYEAC08BK1AB	7.68	26200	5.76	19700	208/240/1/60	2	2	1	27.7	32	Yes
BAYEAC08LG1AB	7.68	26200	5.76	19700	208/240/1/60	2	2	1	27.7	32	No
BAYEAC10BK1AB	9.60	32800	7.20	24600	208/240/1/60	2	2	1	34.6	40	Yes
BAYEAC10LG1AB	9.60	32800	7.20	24600	208/240/1/60	2	2	1	34.6	40	No
BAYEABC15BK1AB	14.40	49200	10.80	36900	208/240/1/60	3	3	2	34.6/17.3	40/20	Yes
BAYEABC20BK1AA	19.20	65600	14.40	49200	208/240/1/60	3	4	2	34.6/34.6	40/40	Yes
BAYEACC25BK1AA	24.00	82000	18.00	61500	208/240/1/60	3	5	3	34.6/34.6/17.3	40/40/20	Yes

BK = Contains circuit breakers  
LG = Contains lug connections

**Table AH-12-B — BAYEV — Heater, Standard, for 7 and 8 Series Air Handlers**

Heater Model Number	Capacity @ 240 Volts		Capacity @ 208 Volts		Rated Voltage	Control Stages	Number of Heater Racks	Number of Circuits	Heater Amps per Circuit		Contains Circuit Breakers
	kW	BTUH	kW	BTUH					208 Volts	240Volt	
BAYEVAC04BK1AA	3.84	13100	2.88	9800	208/240/1/60	1	1	1	13.8	16	Yes
BAYEVAC04LG1AA	3.84	13100	2.88	9800	208/240/1/60	1	1	1	13.8	16	No
BAYEVAC05BK1AB	4.80	16400	3.60	12300	208/240/1/60	1	1	1	17.3	20	Yes
BAYEVAC05LG1AB	4.80	16400	3.60	12300	208/240/1/60	1	1	1	17.3	20	No
BAYEVAC08BK1AB	7.68	26200	5.76	19700	208/240/1/60	2	2	1	27.7	32	Yes
BAYEVAC08LG1AB	7.68	26200	5.76	19700	208/240/1/60	2	2	1	27.7	32	No
BAYEVAC10BK1AB	9.60	32800	7.20	24600	208/240/1/60	2	2	1	34.6	40	Yes
BAYEVAC10LG1AB	9.60	32800	7.20	24600	208/240/1/60	2	2	1	34.6	40	No
BAYEVBC15BK1AB	14.40	49200	10.80	36900	208/240/1/60	3	3	2	34.6/17.3	40/20	Yes
BAYEVBC20BK1AA	19.20	65600	14.40	49200	208/240/1/60	3	4	2	34.6/34.6	40/40	Yes
BAYEVCC25BK1AA	24.00	82000	18.00	61500	208/240/1/60	3	5	3	34.6/34.6/17.3	40/40/20	Yes

BK = Contains circuit breakers  
LG = Contains lug connections

**Table AH-12-C — BAYEC — Heater, Compact, with Lugs, for GAF2 Air Handlers**

Heater Model Number	Capacity @ 240 Volts		Capacity @ 208 Volts		Rated Voltage	Control Stages	Number of Heater Racks	Number of Circuits	Heater Amps per Circuit		Contains Circuit Breakers
	kW	BTUH	kW	BTUH					208 Volts	240Volt	
BAYECAA05LG1BA	4.80	16400	3.60	12300	208/240/1/60	1	1	1	17.3	20	No
BAYECAA08LG1BA	7.68	26200	5.76	19700	208/240/1/60	2	2	1	27.7	32	No
BAYECAA10LG1BA	9.60	32800	7.20	24600	208/240/1/60	2	2	1	34.6	40	No

BAYECPDKIT1 - Optional pull disconnect used with BAYEC heaters only

**Table AH-12-D — BAYEA — Heater, 3-Phase, for 4 Series, 5 Series, GAT2, and GAM2 Air Handlers 1**

Heater Model Number	Capacity @ 240 Volts		Capacity @ 208 Volts		Rated Voltage	Control Stages	Number of Heater Racks	Number of Circuits	Heater Amps per Circuit		Contains Circuit Breakers
	kW	BTUH	kW	BTUH					208 Volts	240Volt	
BAYEAC10LG3AB	9.60	32800	7.20	24600	208/240/3/60	1	3	1	20.0	23.1	No
BAYEABC15LG3AB	14.40	49200	10.80	36900	208/240/3/60	1	3	1	30.0	34.6	No

① 3-Phase - W1, W2, W3 must be jumpered at low voltage connector

**Table AH-12-E — BAYEV — Heater, 3-Phase, for 7 and 8 Series Air Handlers**

Heater Model Number	Capacity @ 240 Volts		Capacity @ 208 Volts		Rated Voltage	Control Stages	Number of Heater Racks	Number of Circuits	Heater Amps per Circuit		Contains Circuit Breakers
	kW	BTUH	kW	BTUH					208 Volts	240Volt	
BAYEVAC10LG3AB	9.60	32800	7.20	24600	208/240/3/60	1	3	1	20.0	23.1	No
BAYEVBC15LG3AB	14.40	49200	10.80	36900	208/240/3/60	1	3	1	30.0	34.6	No

For complete equipment / combination selections, installation instructions and warranty information, please refer to Product Data/Ratings and/or Installers Guides and Limited Warranty Handbooks.

# Heaters for Multi-Position Air Handlers

**Table AH-13-A — Air Handler/Heater Matrix**

AIR HANDLER  MODEL NUMBER	HEATER MODEL NUMBER BAYEA-										
	AC04BK1AA	AC04LG1AA	AC05BK1AB	AC05LG1AB	AC08BK1AB	AC08LG1AB	AC10BK1AB	AC10LG1AB	BC15BK1AB	BC20BK1AA	CC25BK1AA
	3.84 Kw BK	3.84 Kw LG	4.80 Kw BK	4.80 Kw LG	7.68 Kw BK	7.68 Kw LG	9.60 Kw BK	9.60 Kw LG	14.40 Kw BK	19.20 Kw BK	24.00 Kw BK
GAM5B0A18M11	Y	Y	Y	Y	Y	Y	Y	Y	—	—	—
GAM5B0A24M21	Y	Y	Y	Y	Y	Y	Y	Y	—	—	—
GAM5B0B30M21	Y	Y	Y	Y	Y	Y	Y	Y	Y	—	—
GAM5B0B36M31	Y	Y	Y	Y	Y	Y	Y	Y	Y	—	—
GAM5B0C42M31	Y	Y	Y	Y	Y	Y	Y	Y	Y	—	—
GAM5B0C48M41	Y	Y	Y	Y	Y	Y	Y	Y	Y	Y	Y
GAM5B0C60M51	Y	Y	Y	Y	Y	Y	Y	Y	Y	Y	Y
TAM4A0A18S11SD	Y	Y	Y	Y	Y	Y	Y	Y	—	—	—
TAM4A0A24S21SD	Y	Y	Y	Y	Y	Y	Y	Y	—	—	—
TAM4A0A30S21SD	Y	Y	Y	Y	Y	Y	Y	Y	Y	—	—
TAM4A0A36S31SD	Y	Y	Y	Y	Y	Y	Y	Y	Y	—	—
TAM4A0B42S31SD	Y	Y	Y	Y	Y	Y	Y	Y	Y	Y	—
TAM4A0C48S41SD	Y	Y	Y	Y	Y	Y	Y	Y	Y	Y	Y
TAM4A0C60S51SD	Y	Y	Y	Y	Y	Y	Y	Y	Y	Y	Y
GAM2A0A18S11SE	Y	Y	Y	Y	Y	Y	Y	Y	—	—	—
GAM2A0A24S21SE	Y	Y	Y	Y	Y	Y	Y	Y	—	—	—
GAM2A0A30S21SE	Y	Y	Y	Y	Y	Y	Y	Y	Y	—	—
GAM2A0A36S31SE	Y	Y	Y	Y	Y	Y	Y	Y	Y	—	—
GAM2A0B42S31SE	Y	Y	Y	Y	Y	Y	Y	Y	Y	Y	—
GAM2A0C48S41SE	Y	Y	Y	Y	Y	Y	Y	Y	Y	Y	Y
GAM2A0C48S4ASC	Y	Y	Y	Y	Y	Y	Y	Y	Y	Y	Y
GAM2A0C60S51SE	Y	Y	Y	Y	Y	Y	Y	Y	Y	Y	Y
GAM2A0C60S5ASC	Y	Y	Y	Y	Y	Y	Y	Y	Y	Y	Y
HEATER MODEL NUMBER BAYEV-											
TAM8A0A24V21	Y	Y	Y	Y	Y	Y	Y	Y	—	—	—
TAM8A0B30V21	Y	Y	Y	Y	Y	Y	Y	Y	Y	—	—
TAM8A0C36V31	Y	Y	Y	Y	Y	Y	Y	Y	Y	Y	—
TAM8A0C42V31	Y	Y	Y	Y	Y	Y	Y	Y	Y	Y	—
TAM8A0C48V41	Y	Y	Y	Y	Y	Y	Y	Y	Y	Y	Y
TAM8B0C60V51	Y	Y	Y	Y	Y	Y	Y	Y	Y	Y	Y
TAM7A0A24H21	Y	Y	Y	Y	Y	Y	Y	Y	—	—	—
TAM7A0B30H21	Y	Y	Y	Y	Y	Y	Y	Y	Y	—	—
TAM7A0C36H31	Y	Y	Y	Y	Y	Y	Y	Y	Y	Y	—
TAM7A0C42H31	Y	Y	Y	Y	Y	Y	Y	Y	Y	Y	—
TAM7A0C48H41	Y	Y	Y	Y	Y	Y	Y	Y	Y	Y	Y
TAM7B0C60H51	Y	Y	Y	Y	Y	Y	Y	Y	Y	Y	Y

BK = Contains circuit breakers  
LG = Contains lug connections

# Heaters for Multi-Position Air Handlers

**Table AH-14-A — Air Handler/Heater Matrix (continued)**

AIR HANDLER MODEL NUMBER	HEATER MODEL NUMBER BAYEC-		
	AA05LG1BA 4.80 Kw BK	AA08LG1BA 7.68 Kw LG	AA10LG1BA 9.60 Kw LG
GAF2A0A18S11SE	Y	Y	Y
GAF2A0A24S21SE	Y	Y	Y
GAF2A0A30S21SE	Y	Y	Y
GAF2A0A36M31SC	Y	Y	Y
GAF2A0A36S31SE	Y	Y	Y
GAF2A0A36S3ASC	Y	Y	Y

AIR HANDLER MODEL NUMBER	HEATER MODEL NUMBER BAYEA-	
	AC10LG3AB 9.60 Kw LG	BC15LG3AB 9.60 Kw LG
GAM5B0A18M11	Y	—
GAM5B0A24M21	Y	—
GAM5B0B30M21	Y	Y
GAM5B0B36M31	Y	Y
GAM5B0C42M31	Y	Y
GAM5B0C48M41	Y	Y
GAM5B0C60M51	Y	Y
TAM4A0A18S11SD	Y	—
TAM4A0A24S21SD	Y	—
TAM4A0A30S21SD	Y	Y
TAM4A0A36S31SD	Y	Y
TAM4A0B42S31SD	Y	Y
TAM4A0C48S41SD	Y	Y
TAM4A0C60S51SD	Y	Y
GAM2A0A18S11SE	Y	—
GAM2A0A24S21SE	Y	—
GAM2A0A30S21SE	Y	Y
GAM2A0A36S31SE	Y	Y
GAM2A0B42S31SE	Y	Y
GAM2A0C48S41SE	Y	Y
GAM2A0C60S51SE	Y	Y

AIR HANDLER MODEL NUMBER	HEATER MODEL NUMBER BAYEV-	
	AC10LG3AB 9.60 Kw LG	BC15LG3AB 14.4 Kw LG
TAM8A0A24V21	Y	—
TAM8A0B30V21	Y	Y
TAM8A0C36V31	Y	Y
TAM8A0C42V31	Y	Y
TAM8A0C48V41	Y	Y
TAM8B0C60V51	Y	Y
TAM7A0A24H21	Y	—
TAM7A0B30H21	Y	Y
TAM7A0C36H31	Y	Y
TAM7A0C42H31	Y	Y
TAM7A0C48H41	Y	Y
TAM7B0C60H51	Y	Y

# TEM Split System Air Handlers Single Phase 1½-5 Tons

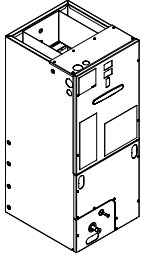

**Table AH-15-A — R-410A Convertible Variable Speed Air Handler 208-230/1/60**

Unit Model No.	Cooling Capacity (Btuh)	Dimensions (in.) H x W x D	Shipping Weight (lbs.)	Supply Opening	Return Opening	Filter Sizes	Line Size Gas Liquid
TEM6A0B24H21SA	24000	46.75 x 18.5 x 21.13	126	16.5 x 12.15	16.75 x 18.75	①	¾ ⅜
TEM6A0B30H21SA	30000	46.75 x 18.5 x 21.13	126	16.5 x 12.15	16.75 x 18.75	①	¾ ⅜
TEM6A0C36H31SA	36000	51.27 x 23.5 x 21.13	155	21.5 x 12.15	21.75 x 18.75	①	7/8 ⅜
TEM6A0C42H41SA	42000	51.27 x 23.5 x 21.13	155	21.5 x 12.15	21.75 x 18.75	①	7/8 ⅜
TEM6A0C48H41SA	48000	55.87 x 23.5 x 21.13	185	21.5 x 12.15	21.75 x 18.75	①	7/8 ⅜
TEM6A0D48H41SA	48000	53.87 x 26.5 x 21.13	181	24.5 x 12.15	24.75 x 18.75	①	7/8 ⅜
TEM6A0C60H51SA	60000	55.87 x 23.5 x 21.13	185	21.5 x 12.15	21.75 x 18.75	①	7/8 ⅜
TEM6A0D60H51SA	60000	53.87 x 26.5 x 21.13	181	24.5 x 12.15	24.75 x 18.75	①	7/8 ⅜

① Filter not supplied. Remote filter required.

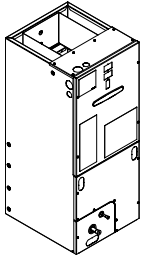

**Table AH-15-B — R-410A Convertible Air Handler 208-230/1/60**

Unit Model No.	Cooling Capacity (Btuh)	Dimensions (in.) H x W x D	Shipping Weight (lbs.)	Supply Opening	Return Opening	Filter Sizes	Line Size Gas Liquid
TEM4A0B18S21SA	18000	45.02 x 18.5 x 21.13	116	16.5 x 12.15	16.75 x 18.75	①	¾ ⅜
TEM4A0B24S21SA	24000	45.02 x 18.5 x 21.13	116	16.5 x 12.15	16.75 x 18.75	①	¾ ⅜
TEM4A0B30S31SA	30000	45.02 x 18.5 x 21.13	116	16.5 x 12.15	16.75 x 18.75	①	¾ ⅜
TEM4A0C36S41SA	36000	51.27 x 23.5 x 21.13	145	21.5 x 12.15	21.75 x 18.75	①	7/8 ⅜
TEM4A0C42S41SA	42000	51.27 x 23.5 x 21.13	145	21.5 x 12.15	21.75 x 18.75	①	7/8 ⅜
TEM4A0C48S41SA	48000	51.27 x 23.5 x 21.13	145	21.5 x 12.15	21.75 x 18.75	①	7/8 ⅜
TEM4A0C60S51SA	60000	51.27 x 23.5 x 21.13	145	21.5 x 12.15	21.75 x 18.75	①	7/8 ⅜

① Filter not supplied. Remote filter required.

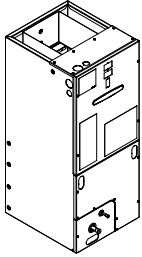

**Table AH-15-C — R-410A Convertible Air Handler 208-230/1/60**

Unit Model No.	Cooling Capacity (Btuh)	Dimensions (in.) H x W x D	Shipping Weight (lbs.)	Supply Opening	Return Opening	Filter Sizes	Line Size Gas Liquid
TEM3A0B18S21SA	18000	45.02 x 18.5 x 21.13	116	16.5 x 12.15	16.75 x 18.75	①	¾ ⅜
TEM3A0B24S21SA	24000	45.02 x 18.5 x 21.13	116	16.5 x 12.15	16.75 x 18.75	①	¾ ⅜
TEM3A0B30S31SA	30000	45.02 x 18.5 x 21.13	116	16.5 x 12.15	16.75 x 18.75	①	¾ ⅜
TEM3A0B36S31SA	36000	45.02 x 18.5 x 21.13	116	16.5 x 12.15	16.75 x 18.75	①	¾ ⅜
TEM3A0C42S41SA	42000	51.27 x 23.5 x 21.13	145	21.5 x 12.15	21.75 x 18.75	①	7/8 ⅜
TEM3A0C48S41SA	48000	51.27 x 23.5 x 21.13	145	21.5 x 12.15	21.75 x 18.75	①	7/8 ⅜
TEM3A0C60S51SA	60000	51.27 x 23.5 x 21.13	145	21.5 x 12.15	21.75 x 18.75	①	7/8 ⅜

① Filter not supplied. Remote filter required.

# TEM Split System Air Handlers Single Phase 1½-5 Tons

**Table AH-16-A — Features**

	TEM6 2-5	TEM4 1 1/2-5	TEM3 1 1/2-5
• Painted metal cabinet with captured foil face insulation	✓	✓	✓
• 2% or less air leakage	✓	✓	✓
• Variable Speed ECM Motor	✓	—	—
• ECM Motor	—	3½-5	5
• PSC Motor	—	1½-3	1½-4
• R-4.2 Insulating Value	✓	✓	✓
• Multi-Position UP/Down Flow*, Horizontal Left /Right	✓	✓	✓
• ALL Aluminum Coil with Enhanced Patented Coil Fin	✓	✓	✓
• Electric Heaters with polarized plug connections (sold as accessory)	✓	✓	✓
• R-410A Thermal Expansion Valve	✓	✓	✓
• Low Voltage Pigtail Connections	✓	✓	✓
• Draw Through Design	✓	✓	✓
• Horizontal Drain pan	✓	✓	✓
• Single Color	✓	✓	✓
• Fused 24V Power	✓	✓	✓
• Wipeable interior design	✓	✓	✓
• Soft start fan motor operation	✓	—	—
• Comfort R Mode	✓	—	—
• Built in fan delay modes	✓	—	—
• Maximum Width 26.5"	✓	—	—
• Maximum Width 23.5"	✓	✓	✓
• Compact 22" depth	✓	✓	✓
• Draw through design	✓	✓	✓
• 1 year warranty	✓	✓	✓
• 10-year warranty registered	✓	✓	✓
• Optional extended warranty available	✓	✓	✓

**Table AH-16-B — Optional Accessories**

Model Number	Description	Matches Cabinet Size(s)	TEM6	TEM4	TEM3
BAYTEMSPFG1	Supply Duct Flange Kit		✓	✓	✓
BAYSPEKT201A	Single Point Power Entry Kit		✓	✓	✓
TAYBASE185	Air Handler Downflow Sub-Bases	18.5"	✓	✓	✓
TAYBASE235 (TAYBASE100)	Air Handler Downflow Sub-Bases	23.5"	✓	✓	✓
TAYBASE260 (TAYBASE102)	Air Handler Downflow Sub-Bases	26.5"	✓	—	—
BAYTEMDFKT1A	Downflow Condensate Management Kit	23.5" ①	—	✓	✓
BAYSF1185AAA	Slim Fit Filter Box Kit	18.5"	✓	✓	✓
BAYSF1235AAA	Slim Fit Filter Box Kit	23.5"	✓	✓	✓
BAYSF1265AAA	Slim Fit Filter Box Kit	26.5"	✓	—	—
FLRSF1185	1" Slim Fit Replacement Filter, 17.75"x19.75", Qty 12	18.5"	✓	✓	✓
FLRSF1235	1" Slim Fit Replacement Filter, 22.75"x19.75", Qty 12	23.5"	✓	✓	✓
FLRSF1265	1" Slim Fit Replacement Filter, 25.75"x19.75", Qty 12	26.5"	✓	—	—
BAY6TXV2442A	R-22 TXV conversion kit		2-3½	—	—
BAY6TXV4860A	R-22 TXV conversion kit		4-5	—	—
BAYATXV1836B	R-22 TXV conversion kit		—	1½-2½	1½-3
BAYATXV4248B	R-22 TXV conversion kit		—	3-4	3½-4
BAYATXV6161B	R-22 TXV conversion kit		—	5	5

① Downflow condensate management kit is required for 5 Ton downflow models.



# Heaters for TEM Split System Air Handlers

**Table AH-17-A — BAYHTR15 — Heater, Standard, for Series 3 Air Handlers**

Heater Model Number	Capacity @ 240 Volts		Capacity @ 208 Volts		Rated Voltage	Control Stages	Number of Heater Racks	Number of Circuits	Heater Amps per Circuit		Contains Circuit Breakers
	kW	BTUH	kW	BTUH					208 Volts	240Volt	
BAYHTR1504BRKC	3.84	13100	2.88	9800	208/240/1/60	1	1	1	13.8	16	Yes
BAYHTR1504PDCA	3.84	13100	2.88	9800	208/240/1/60	1	1	1	13.8	16	No
BAYHTR1504LUGB	3.84	13100	2.88	9800	208/240/1/60	1	1	1	13.8	16	No
BAYHTR1505BRKC	4.80	16400	3.60	12300	208/240/1/60	1	1	1	17.3	20	Yes
BAYHTR1505PDCA	4.80	16400	3.60	12300	208/240/1/60	1	1	1	17.3	20	No
BAYHTR1505LUGB	4.80	16400	3.60	12300	208/240/1/60	1	1	1	17.3	20	No
BAYHTR1508BRKC	7.68	26200	5.76	19700	208/240/1/60	1	1	1	27.7	32	Yes
BAYHTR1508PDCA	7.68	26200	5.76	19700	208/240/1/60	1	1	1	27.7	32	No
BAYHTR1508LUGB	7.68	26200	5.76	19700	208/240/1/60	1	1	1	27.7	32	No
BAYHTR1510BRKC	9.60	32800	7.20	24600	208/240/1/60	1	2	1	34.6	40	Yes
BAYHTR1510PDCA	9.60	32800	7.20	24600	208/240/1/60	1	2	1	34.6	40	No
BAYHTR1510LUGB	9.60	32800	7.20	24600	208/240/1/60	1	2	1	34.6	40	No
BAYHTR1515BRKB	14.4	49200	10.8	36900	208/240/1/60	2	3	2	51.9	60	Yes
BAYHTR1516BRKB	14.4	49200	10.8	36900	208/240/1/60	2	3	2	51.9	60	Yes
BAYHTR1519BRKB	19.2	65500	14.4	49200	208/240/1/60	2	4	2	69.2	80	Yes
BAYHTR1520BRKB	19.2	65500	14.4	49200	208/240/1/60	2	4	2	69.2	80	Yes
BAYHTR1521BRKB	19.2	65500	14.4	49200	208/240/1/60	2	4	2	69.2	80	Yes
BAYHTR1522BRKA	19.2	65500	14.4	49200	208/240/1/60	2	4	2	69.2	80	Yes
BAYHTR1525BRKA	24.0	81900	18.0	61600	208/240/1/60	2	4	2	86.4	100	Yes

BRK = Contains circuit breakers

PDC = Pull disconnects

LUG = Lug connections

**Table AH-17-B — BAYHTR35 — Heater, 3-Phase, for Series 3 Air Handlers** ①

Heater Model Number	Capacity @ 240 Volts		Capacity @ 208 Volts		Rated Voltage	Control Stages	Number of Heater Racks	Number of Circuits	Heater Amps per Circuit		Contains Circuit Breakers
	kW	BTUH	kW	BTUH					208 Volts	240Volt	
BAYHTR3510LUGC	9.60	32800	7.20	24600	208/240/1/60	1	3	1	20.0	23.1	No
BAYHTR3515LUGC	14.4	49200	10.8	36900	208/240/1/60	1	3	1	30.0	34.6	No

LUG = Contains Lug terminals

① 3-Phase - W1 and W2 must be jumpered at low voltage connector

# Heaters for TEM Split System Air Handlers

**Table AH-18-A — TEM6 Air Handler and Heater matches**

TEM6 HEATER MATRIX									
AIR HANDLER	HEATER MODEL NUMBER								
MODEL NUMBER	BAYHTR1504BRK* BAYHTR1504LUG* 3.84 Kw	BAYHTR1505BRK* BAYHTR1505LUG* 4.80 Kw	BAYHTR1508BRK* BAYHTR1508LUG* 7.68 Kw	BAYHTR1510BRK* BAYHTR1510LUG* 9.60 Kw	BAYHTR1516BRK* 14.40 Kw	BAYHTR1522BRK* 19.20 Kw	BAYHTR1525BRK* 24.00 Kw	BAYHTR3510LUG* 9.60 Kw	BAYHTR3515LUG* 14.40 Kw
TEM6A0B24H21S* TEM6A0B30H21S*	Y	Y	Y	Y	Y	-	-	Y	Y
TEM6A0C36H31S* TEM6A0C42H41S*	Y	Y	Y	Y	Y	Y	-	Y	Y
TEM6A0C48H41S* TEM6A0C60H51S*	Y	Y	Y	Y	Y	Y	Y	Y	Y

\* = Followed by two digits

**Table AH-18-B — TEM3 and TEM4 Air Handler and Heater matches**

TEM3/TEM4 HEATER MATRIX						
AIR HANDLER	HEATER MODEL NUMBER					
MODEL NUMBER	BAYHTR1504BRK* BAYHTR1504PDC* BAYHTR1504LUG* 3.84 Kw BK BAYHTR1505BRK* BAYHTR1505PDC* BAYHTR1505LUG* 4.80 Kw BK	BAYHTR1508BRK* BAYHTR1508PDC* BAYHTR1508LUG* 7.68 Kw BK BAYHTR1510BRK* BAYHTR1510PDC* BAYHTR1510LUG* BAYHTR3510LUGB 9.60 Kw BK	BAYHTR1515BRK* BAYHTR3515LUGB 14.40 Kw BK	BAYHTR1519BRK* 19.20 Kw BK	BAYHTR1520BRK* 19.20 Kw BK	BAYHTR1521BRK* 19.20 Kw BK
TEM3A0B18S21S* TEM4A0B18S21S* TEM3A0B24S21S* TEM4A0B24S21S*	Y	Y	--	--	--	--
TEM3A0B30S31S* TEM4A0B30S31S* TEM3A0B36S31S*	Y	Y	Y	Y	--	--
TEM4A0C36S41S* TEM3A0C42S41S* TEM4A0C42S41S*	Y	Y	Y	--	Y	
TEM3A0C48S41S* TEM4A0C48S41S*	Y	Y	Y	--	Y	--
TEM3A0C60S51S* TEM4A0C60S51S*	Y	Y	Y	--	Y	--

\* = Followed by two digits

# TMM Wall, Stud, or Over the Water Heater Mount Air Handlers Single Phase 1-1/2 - 3 Tons

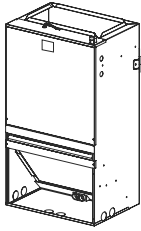

**Table AH-19-A — R-410A Wall, Stud, or Over the Water Heater Mount Air Handler 208-230/1/60, ECM Motor, Factory installed R-410A TXV**

Unit Model No.	Cooling Capacity (Btuh)	Dimensions (in.) H x W x D	Shipping Weight (lbs.)	Supply Opening	Filter Sizes	Line Size	
						Gas	Liquid
TMM5A0B24M21SA	24000	39.5 x 22.0 x 19.0	115	18.75 x 9.5	①	3/4	3/8
TMM5A0B30M21SA	30000	39.5 x 22.0 x 19.0	117	18.75 x 9.5	①	3/4	3/8
TMM5A0B36M31SA	36000	39.5 x 22.0 x 19.0	117	18.75 x 9.5	①	3/4	3/8

**Table AH-19-B — TMM4 R-410A Wall, Stud, or Over the Water Heater Mount Air Handler 208-230/1/60**

Unit Model No.	Cooling Capacity (Btuh)	Dimensions (in.) H x W x D	Shipping Weight (lbs.)	Supply Opening	Filter Sizes	Line Size	
						Gas	Liquid
TMM4A0A18S21SA	18000	36.5 x 20.5 x 15.0	99	17.25 x 9.5	①	3/4	3/8
TMM4A0A24S21SA	24000	36.5 x 20.5 x 15.0	99	17.25 x 9.5	①	3/4	3/8
TMM4A0B30S21SA	30000	39.5 x 22.0 x 19.0	121	18.75 x 9.5	①	3/4	3/8
TMM4A0B36S31SA	36000	39.5 x 22.0 x 19.0	121	18.75 x 9.5	①	3/4	3/8

① Filter not supplied. Remote filter required.

**Table AH-19-C — Features**

	TMM5 2-3	TMM4 1-1/2-3
• Painted metal cabinet with captured foil face insulation	✓	✓
• 2% or less air leakage	✓	✓
• ECM Motor, Constant torque with Fan-off time delay programming	✓	—
• PSC Motor	—	✓
• R-4.2 Insulating Value	✓	✓
• Upflow only	✓	✓
• Front return option	✓	✓
• High Efficiency Copper / Aluminum Coil	✓	✓
• Electric Heaters with polarized plug connections (sold as accessory)	✓	✓
• R-410A Thermal Expansion Valve	✓	—
• Low Voltage Pigtail Connections	✓	✓
• Horizontal Drain pan	✓	✓
• Single Color	✓	✓
• Fused 24V Power	✓	✓
• Wipeable interior design	✓	✓
• Maximum Height 39.5"	✓	✓
• Maximum Width 22"	✓	✓
• Compact 22" depth	✓	✓
• Optional R-22 and R-410A TXV kits (sold as accessory)	✓	✓
• <b>1 year warranty</b>	✓	✓
• <b>10-year warranty registered</b>	✓	✓
• <b>Optional extended warranty available</b>	✓	✓

**Table AH-19-D — Optional Accessories**

Model		TMM5	TMM4
4AYTXVH3G2436A	R-410A TXV kit 1-1/2 to 3 ton	—	✓
2AYTXVH3G2436A	R-22 TXV conversion kit 1-1/2 to 3 ton	✓	✓
BAYFRTLLOUPNL20	Front louver panel 20.5" width	—	✓
BAYFRTLLOUPNL22	Front louver panel 22.0" width	✓	✓
BAYTMMWALLPNL1	Return air / service wall panel	✓	✓

## Heaters for TMM Split System Air Handlers

**Table AH-19-E — BAYHTRM — Heater, Standard, for TMM Air Handlers**

Heater Model Number	Capacity @ 240 Volts		Capacity @ 208 Volts		Rated Voltage	Control Stages	Number of Heater Racks	Number of Circuits	Heater Amps per Circuit		Contains Circuit Breakers
	kW	BTUH	kW	BTUH					208 Volts	240 Volt	
BAYHTRM505BRK	5.0	17100	3.8	12800	208/240/1/60	1	1	1	18	20.8	Yes
BAYHTRM508BRK	7.5	25600	5.6	19200	208/240/1/60	1	1	1	27.1	31.2	Yes
BAYHTRM510BRK	10.0	34100	7.5	25600	208/240/1/60	1	2	1	36.1	41.7	Yes

For complete equipment / combination selections, installation instructions and warranty information, please refer to Product Data/Ratings and/or Installers Guides and Limited Warranty Handbooks.

# 4FW Air Handlers

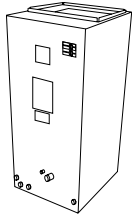

**Table AH-20-A — Convertible Air Handler - Constant Torque ECM Motor - R4.2 Models**

Unit Model No.	Cooling Capacity (Btuh)	Dimensions (in.) H x W x D	Shipping Weight (lbs.)	Supply Opening	Return Opening	Filter Sizes	Line Size Gas	Line Size Liquid
4FWHF024A1000①	24000	45.0 x 19.75 x 21.5	73	18.25 x 15.0	15.75 x 18.75	Remote*	3/4	3/8
4FWHF025A1000①	24000	45.0 x 19.75 x 21.5	73	18.25 x 15.0	15.75 x 18.75	Remote*	3/4	3/8
4FWHF030A1000①	30000	45.0 x 19.75 x 21.5	73	18.25 x 15.0	15.75 x 18.75	Remote*	3/4	3/8
4FWHF036A1000①	36000	45.0 x 19.75 x 21.5	73	18.25 x 15.0	15.75 x 18.75	Remote*	3/4	3/8
4FWHF042A1000C②	42000	51.0 x 22.0 x 22.75	94	20.75 x 15.5	19 x 19.5	Remote*	7/8	3/8
4FWHF042A1000①	42000	51.0 x 23.0 x 22.5	94	21.75 x 15.5	19 x 19.5	Remote*	7/8	3/8
4FWHF048A1000C②	48000	51.0 x 22.0 x 22.75	94	20.75 x 15.5	19 x 19.5	Remote*	7/8	3/8
4FWHF048A1000①	48000	51.0 x 23.0 x 22.5	94	21.75 x 15.5	19 x 19.5	Remote*	7/8	3/8
4FWHF060A1000C②	60000	51.0 x 22.0 x 22.75	94	20.75 x 15.5	19 x 19.5	Remote*	7/8	3/8
4FWHF060A1000①	60000	51.0 x 23.0 x 22.5	94	21.75 x 15.5	19 x 19.5	Remote*	7/8	3/8
4FWHF061A1000C②	60000	51.0 x 22.0 x 22.75	94	20.75 x 15.5	19 x 19.5	Remote*	7/8	3/8
4FWHF061A1000①	60000	51.0 x 23.0 x 22.5	94	21.75 x 15.5	19 x 19.5	Remote*	7/8	3/8

\*Field Supplied

① 14th digit "A" models are phased out. 14th digit "B" models are shipped pressurized.

② 14th digit "B" models are phasing out. 14th digit "C" models are shipped pressurized.

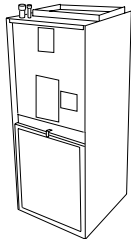

**Table AH-20-B — Stud Mount Air Handler with Factory Installed Electric Heat - R4.2 Models**

Unit Model No.	Cooling Capacity (Btuh)	Dimensions (in.) H x W x D	Shipping Weight (lbs.)	Supply Opening	Return Opening	Filter Sizes	Line Size Gas	Line Size Liquid
4FWMF024A1005①	24000	36.75 x 18.25 x 18	57	11 x 16.5	18 x 18	18 x 18 x 1	3/4	3/8
4FWMF024A1DS5①	24000	36.75 x 18.25 x 18	57	11 x 16.5	18 x 18	18 x 18 x 1	3/4	3/8
4FWMF024A1008①	24000	36.75 x 18.25 x 18	57	11 x 16.5	18 x 18	18 x 18 x 1	3/4	3/8
4FWMF024A1DS8①	24000	36.75 x 18.25 x 18	57	11 x 16.5	18 x 18	18 x 18 x 1	3/4	3/8
4FWMF024A1010①	24000	36.75 x 18.25 x 18	57	11 x 16.5	18 x 18	18 x 18 x 1	3/4	3/8
4FWMF024A1DS10①	24000	36.75 x 18.25 x 18	57	11 x 16.5	18 x 18	18 x 18 x 1	3/4	3/8
4FWMF030A1008①	30000	36.75 x 18.25 x 18	57	11 x 16.5	18 x 18	18 x 18 x 1	3/4	3/8
4FWMF030A1DS8①	30000	36.75 x 18.25 x 18	57	11 x 16.5	18 x 18	18 x 18 x 1	3/4	3/8
4FWMF030A1010①	30000	36.75 x 18.25 x 18	57	11 x 16.5	18 x 18	18 x 18 x 1	3/4	3/8
4FWMF030A1DS10①	30000	36.75 x 18.25 x 18	57	11 x 16.5	18 x 18	18 x 18 x 1	3/4	3/8
4FWMF031A1008①	30000	40 x 20.5 x 22	65	15 x 19	20 x 20	20 x 20 x 1	3/4	3/8
4FWMF031A1DS8①	30000	40 x 20.5 x 22	65	15 x 19	20 x 20	20 x 20 x 1	3/4	3/8
4FWMF031A1010①	30000	40 x 20.5 x 22	65	15 x 19	20 x 20	20 x 20 x 1	3/4	3/8
4FWMF031A1DS10①	30000	40 x 20.5 x 22	65	15 x 19	20 x 20	20 x 20 x 1	3/4	3/8
4FWMF036A1010①	36000	40 x 20.5 x 22	65	15 x 19	20 x 20	20 x 20 x 1	3/4	3/8
4FWMF036A1DS10①	36000	40 x 20.5 x 22	65	15 x 19	20 x 20	20 x 20 x 1	3/4	3/8
4FWMF036A1015①	36000	40 x 20.5 x 22	65	15 x 19	20 x 20	20 x 20 x 1	3/4	3/8

**Table AH-20-C — Optional Accessories**

Model Number	Description	4FWMA/F
BAYFPNLWAL01AA.....	Wall Return Grill, Louvered .....	024-030
BAYFPNLWAL02AA.....	Wall Return Grill, Louvered .....	031-036
BAYFPNLLOU01AA.....	Unit Return Grill, Louvered .....	024-030
BAYFPNLLOU02AA.....	Unit Return Grill, Louvered .....	031-036
BAYFPNLSOL01AA.....	Lower Coil Panel, Solid .....	024-030
BAYFPNLSOL02AA.....	Lower Coil Panel, Solid .....	031-036

\*Field Supplied

① 14th digit "A" models are phased out. 14th digit "B" models are shipped pressurized.

# 4FW Air Handlers

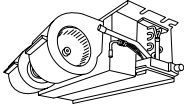

**Table AH-21-A — Furr-Down Air Handlers - Uncased with Factory Installed Electric Heat**

Unit Model No.	Cooling Capacity (Btuh)	Dimensions (in.) H x W x D	Shipping Weight (lbs.)	Supply Opening	Return Opening	Filter Sizes	Line Size	
							Gas	Liquid
4FWDA022A1005①	24000	10.25 x 37.25 x 22	60	7 x 30	37.25 x 22	Remote*	3/4	3/8
4FWDA022A1008①	24000	10.25 x 37.25 x 22	60	7 x 30	37.25 x 22	Remote*	3/4	3/8
4FWDA022A1010①	24000	10.25 x 37.25 x 22	60	7 x 30	37.25 x 22	Remote*	3/4	3/8
4FWDA024A1005①	24000	10.25 x 43.25 x 22	64	7 x 36	43.25 x 22	Remote*	3/4	3/8
4FWDA024A1008①	24000	10.25 x 43.25 x 22	64	7 x 36	43.25 x 22	Remote*	3/4	3/8
4FWDA024A1010①	24000	10.25 x 43.25 x 22	64	7 x 36	43.25 x 22	Remote*	3/4	3/8
4FWDA030A1008①	30000	10.25 x 43.25 x 22	64	7 x 36	43.25 x 22	Remote*	3/4	3/8
4FWDA030A1010①	30000	10.25 x 43.25 x 22	64	7 x 36	43.25 x 22	Remote*	3/4	3/8
4FWDA036A1010①	36000	10.25 x 43.25 x 22	74	7 x 42	43.25 x 22	Remote*	3/4	3/8

**Table AH-21-B — Furr-Down Uncased Air Handlers and Heater Matrix — 4FWDA**

AIR HANDLER MODEL NUMBER WITH FACTORY INSTALLED HEATER			
Model +	5 Kw Terminal Block	8 Kw Terminal Block	10 Kw Terminal Block
4FWDA022	A1005A	A1008A	A1010A
4FWDA024	A1005A	A1008A	A1010A
4FWDA030	N/A	A1008A	A1010A
4FWDA036	N/A	N/A	A1010A

Note: Complete model number includes air handler size plus factory installed heater selection.  
Example: 4FWDA024A1005A = a 2 ton air handler with 5 Kw electric heater with terminal block

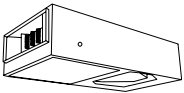

**Table AH-21-C — Furr-Down Air Handlers - Cased with Factory Installed Electric Heat**

Unit Model No.	Cooling Capacity (Btuh)	Dimensions (in.) H x W x D	Shipping Weight (lbs.)	Supply Opening	Return Opening	Filter Sizes	Line Size	
							Gas	Liquid
4FWFA024A1005①	24000	12 x 47 x 22.5	55	8 x 20.75	21 x 21.5	22 x 22 x 1	3/4	3/8
4FWFA024A1008①	24000	12 x 47 x 22.5	55	8 x 20.75	21 x 21.5	22 x 22 x 1	3/4	3/8
4FWFA024A1010①	24000	12 x 47 x 22.5	55	8 x 20.75	21 x 21.5	22 x 22 x 1	3/4	3/8
4FWFA030A1008①	30000	12 x 47 x 22.5	55	8 x 20.75	21 x 21.5	22 x 22 x 1	3/4	3/8
4FWFA030A1010①	30000	12 x 47 x 22.5	60	8 x 20.75	21 x 21.5	22 x 22 x 1	3/4	3/8
4FWFA031A1008①	30000	12 x 51 x 22.5	60	8 x 20.75	21 x 21.5	22 x 22 x 1	3/4	3/8
4FWFA031A1010①	30000	12 x 51 x 22.5	60	8 x 20.75	21 x 21.5	22 x 22 x 1	3/4	3/8
4FWFA036A1010①	36000	12 x 51 x 22.5	60	8 x 20.75	21 x 21.5	22 x 22 x 1	3/4	3/8

\*Field Supplied

**Table AH-21-D — Furr-Down Air Handlers - Cased with Factory Installed Electric Heat — 4FWFA**

AIR HANDLER MODEL NUMBER WITH FACTORY INSTALLED HEATER			
Model +	5 Kw Terminal Block	8 Kw Terminal Block	10 Kw Terminal Block
4FWFA024	A1005A	A1008A	A1010A
4FWFA030,31	N/A	A1008A	A1010A
4FWFA036	N/A	N/A	A1010A

Note: Complete model number includes air handler size plus factory installed heater selection.  
Example: 4FWFA024A1005A = a 2 ton air handler with 5 Kw electric heater with terminal block.

\*Field Supplied  
① 14th digit "A" models are phased out. 14th digit "B" models are shipped pressurized.

# Heaters 4FW Air Handlers

Table AH-22-A — Heaters 4FW Air Handlers

BAYHTR -- HEATER DATA											
HEATER MODEL NUMBER	CAPACITY @ 240 VOLT		CAPACITY @ 208 VOLT		VOLTAGE	CONTROL STAGES	NUMBER OF HEATER RACKS	NO. OF CIRCUITS	HEATER AMPS PER CIRCUIT 208 VOLT	HEATER AMPS PER CIRCUIT 240 VOLT	CONTAINS CIRCUIT BREAKERS
	kW	BTUH	kW	BTUH							
	BAYHTR**1403SL0	3	10200	2.25							
BAYHTR**1405SL0	4.8	16400	3.6	12300	208/240/1/60	1	1	1	17.3	20	No
BAYHTR**1406SL0	6	20500	4.5	15400	208/240/1/60	1	1	1	21.6	25	No
BAYHTR**1408SL0	8	27300	6	20500	208/240/1/60	1	2	1	28.8	33.3	No
BAYHTR**1410SL0	9.6	32800	7.2	24600	208/240/1/60	1	2	1	34.6	40	No
BAYHTRBK1415SL0	14.4	49100	10.8	36800	208/240/1/60	1	3	2	34.6/17.3	40/20	Yes
BAYHTRBK1420SL0	19.2	65500	14.4	49100	208/240/1/60	1	4	2	34.6/34.6	40/40	Yes
BAYHTRDS1405BL0	4.8	16400	3.6	12300	208/240/1/60	1	1	1	17.3	20	No
BAYHTRDS1408BL0	8	27300	6	20500	208/240/1/60	1	2	1	28.8	33.3	No
BAYHTR**1410BL0	9.6	32800	7.2	24600	208/240/1/60	1	2	1	34.6	40	No
BAYHTRBK1415BL0	14.4	49100	10.8	36800	208/240/1/60	1	3	2	34.6/17.3	40/20	Yes
BAYHTRBK1420BL0	19.2	65500	14.4	49100	208/240/1/60	1	4	2	34.6/34.6	40/40	Yes

Note: Heaters with two circuits are displayed as Circuit 1/Circuit 2 (Minimum Circuit Ampacity for Circuit 1 includes Blower Motor Amp)

\*\* = DS or Blank (DS = Pull Disconnect, Blank = terminal block)

# Heaters 4FW Air Handlers

Table AH-23-A — Heaters 4FW Air Handlers

MINIMUM HEATING AIRFLOW CFM - HEATER MATRIX												
4FWCA, 4FWCF AIR HANDLER	HEATER											
MODEL NUMBER	BAYHTR1403SLO BAYHTRDS1403SLO 3 kW	BAYHTR1405SLO BAYHTRDS1405SLO 5 kW	BAYHTR1406SLO BAYHTRDS1406SLO 6 kW	BAYHTR1408SLO BAYHTRDS1408SLO 8 kW	BAYHTR1410SLO BAYHTRDS1410SLO 10 kW	BAYHTRBK1415SLO 15 kW	BAYHTRBK1420SLO 20 kW	BAYHTR1405BLO - 5 kW	BAYHTR1408BLO - 8 kW	BAYHTR1410BLO BAYHTRDS1410BLO 10 kW	BAYHTRBK1415BLO 15 kW	BAYHTRBK1420BLO 20 kW
4FWCA024A1000① / 4FWCF024A1000① 4FWCA025A1000① / 4FWCF025A1000①	L / L	L / L	L / L	L / L	M / L							
4FWCA030A1000① / 4FWCF030A1000① 4FWCA031A1000① / 4FWCF031A1000①	L / L	L / L	L / L	L / L	L / L	L / L						
4FWCA036A1000① / 4FWCF036A1000①	L / L	L / L	L / L	L / L	L / L	M / L	M / L					
4FWCA048A1000① / 4FWCF048A1000① 4FWCA049A1000① / 4FWCF049A1000①								L / L	L / L	L / L	M / L	H / M
4FWCA060A1000① / 4FWCF060A1000① 4FWCA061A1000① / 4FWCF061A1000①								L / L	L / L	L / L	L / L	M / M
HEAT PUMP / COOLING												

MINIMUM HEATING AIRFLOW CFM - HEATER MATRIX												
4FWHA, 4FWHF AIR HANDLER	HEATER											
MODEL NUMBER	BAYHTR1403SLO BAYHTRDS1403SLO 3 kW	BAYHTR1405SLO BAYHTRDS1405SLO 5 kW	BAYHTR1406SLO BAYHTRDS1406SLO 6 kW	BAYHTR1408SLO BAYHTRDS1408SLO 8 kW	BAYHTR1410SLO BAYHTRDS1410SLO 10 kW	BAYHTRBK1415SLO 15 kW	BAYHTRBK1420SLO 20 kW	BAYHTR1405BLO - 5 kW	BAYHTR1408BLO - 8 kW	BAYHTR1410BLO BAYHTRDS1410BLO 10 kW	BAYHTRBK1415BLO 15 kW	BAYHTRBK1420BLO 20 kW
4FWHA024A1000① / 4FWHF024A1000① 4FWHA025A1000① / 4FWHF025A1000①	Tap 1 / Tap 1	Tap 1 / Tap 1	Tap 1 / Tap 1	Tap 2 / Tap 1	Tap 3 / Tap 2							
4FWHA030A1000① / 4FWHF030A1000①	Tap 1 / Tap 1	Tap 1 / Tap 1	Tap 1 / Tap 1	Tap 1 / Tap 1	Tap 2 / Tap 1	Tap 3 / Tap 2						
4FWHA036A1000① / 4FWHF036A1000①	Tap 1 / Tap 1	Tap 1 / Tap 1	Tap 1 / Tap 1	Tap 1 / Tap 1	Tap 2 / Tap 1	Tap 3 / Tap 2	Tap 3 / Tap 3					
4FWHA042A1000① / 4FWHF042A1000①								Tap 1 / Tap 1	Tap 1 / Tap 1	Tap 1 / Tap 1	Tap 2 / Tap 1	Tap 3 / Tap 2
4FWHA048A1000① / 4FWHF048A1000①								Tap 1 / Tap 1	Tap 1 / Tap 1	Tap 1 / Tap 1	Tap 1 / Tap 1	Tap 2 / Tap 1
4FWHA060A1000① / 4FWHF060A1000① 4FWHA061A1000① / 4FWHF061A1000①								Tap 1 / Tap 1	Tap 1 / Tap 1	Tap 1 / Tap 1	Tap 2 / Tap 1	Tap 3 / Tap 2
HEAT PUMP / COOLING												

\*Field Supplied  
① 14th digit "A" models are phased out. 14th digit "B" models are shipped pressurized.

# Split System – Cased Heat Pump and Cooling Coils

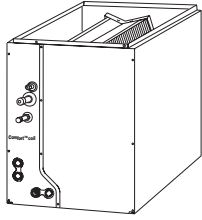

**4TXC-DS  
Comfort™ Coil**

**Table COIL-1-A — Aluminum High Efficiency Staged System Cased Coil Convertible (Upflow/ Downflow/ Horizontal Left or Right) R-410A Refrigerant**

Model Number	Nom. Cap. Cooling (Btuh)	Coil Type	Refrigerant Control	Outlet Dim. (in.) W/H x D	Overall Dim. (in.) H x W x D	Shipping Weight (lbs.)	Line Size OD Gas	Line Size OD Liq.
4TXCA002DS3HCA	24,000	A	TXVNB①	12 <sup>3</sup> / <sub>4</sub> x 19 <sup>3</sup> / <sub>8</sub>	17.5 x 14.5 x 21.5	42	3/4	3/8
4TXCB003DS3HCA	30,000	A	TXVNB①	15 <sup>3</sup> / <sub>4</sub> x 19 <sup>3</sup> / <sub>8</sub>	17.5 x 17.5 x 21.5	50	3/4	3/8
4TXCB004DS3HCA	36,000	A	TXVNB①	15 <sup>3</sup> / <sub>4</sub> x 19 <sup>3</sup> / <sub>8</sub>	22.5 x 17.5 x 21.5	58	7/8	3/8
4TXCC005DS3HCA	36,000	A	TXVNB①	19 <sup>1</sup> / <sub>4</sub> x 19 <sup>3</sup> / <sub>8</sub>	22.5 x 21 x 21.5	60	7/8	3/8
4TXCB006DS3HCA	48,000	A	TXVNB①	15 <sup>3</sup> / <sub>4</sub> x 19 <sup>3</sup> / <sub>8</sub>	26.9 x 17.5 x 21.5	65	7/8	3/8
4TXCC007DS3HCA	48,000	A	TXVNB①	19 <sup>1</sup> / <sub>4</sub> x 19 <sup>3</sup> / <sub>8</sub>	26.9 x 21 x 21.5	69	7/8	3/8
4TXCD008DS3HCA	48,000	A	TXVNB①	22 <sup>3</sup> / <sub>4</sub> x 19 <sup>3</sup> / <sub>8</sub>	26.9 x 24.5 x 21.5	72	7/8	3/8
4TXCC009DS3HCA	60,000	A	TXVNB①	19 <sup>1</sup> / <sub>4</sub> x 19 <sup>3</sup> / <sub>8</sub>	30.7 x 21 x 21.5	78	7/8	3/8
4TXCD010DS3HCA	60,000	A	TXVNB①	22 <sup>3</sup> / <sub>4</sub> x 19 <sup>3</sup> / <sub>8</sub>	30.7 x 24.5 x 21.5	81	7/8	3/8

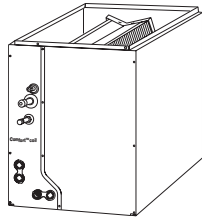

**4TXC-CC  
Comfort™ Coil**

**Table COIL-1-B — Aluminum High Efficiency Staged System Cased Coil Convertible (Upflow/ Downflow/ Horizontal Left or Right) R-410A Refrigerant**

Model Number	Nom. Cap. Cooling (Btuh)	Coil Type	Refrigerant Control	Outlet Dim. (in.) W/H x D	Overall Dim. (in.) H x W x D	Shipping Weight (lbs.)	Line Size OD Gas	Line Size OD Liq.
4TXCB003CC3HCB	24,000	A	TXVNB①	15 <sup>5</sup> / <sub>8</sub> x 19 <sup>3</sup> / <sub>8</sub>	22.6 x 17.5 x 21.5	45	5/8	3/8
4TXCB004CC3HCB	36,000	A	TXVNB①	15 <sup>5</sup> / <sub>8</sub> x 19 <sup>3</sup> / <sub>8</sub>	26.9 x 17.5 x 21.5	49	3/4	3/8
4TXCC005CC3HCB	36,000	A	TXVNB①	19 <sup>1</sup> / <sub>8</sub> x 19 <sup>3</sup> / <sub>8</sub>	26.9 x 21 x 21.5	51	3/4	3/8
4TXCC006CC3HCB	24,000	A	TXVNB①	19 <sup>1</sup> / <sub>8</sub> x 19 <sup>3</sup> / <sub>8</sub>	22.6 x 21 x 21.5	48	5/8	3/8
4TXCC007CC3HCB	36,000	A	TXVNB①	19 <sup>1</sup> / <sub>8</sub> x 19 <sup>3</sup> / <sub>8</sub>	26.9 x 21 x 21.5	51	3/4	3/8
4TXCC008CC3HCC	60,000	A	TXVNB①	19 <sup>1</sup> / <sub>8</sub> x 19 <sup>3</sup> / <sub>8</sub>	30.7 x 21 x 21.5	65	3/4	3/8
4TXCD009CC3HCC	60,000	A	TXVNB①	22 <sup>5</sup> / <sub>8</sub> x 19 <sup>3</sup> / <sub>8</sub>	30.7 x 24.6 x 21.5	68	3/4	3/8
4TXCD010CC3HCC	60,000	A	TXVNB①	22 <sup>5</sup> / <sub>8</sub> x 19 <sup>3</sup> / <sub>8</sub>	30.7 x 24.6 x 21.5	68	3/4	3/8

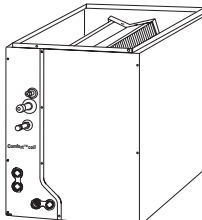

**4TXC-BC  
Comfort™ Coil**

**Table COIL-1-C — Aluminum Cased Coil Convertible (Upflow/ Downflow/ Horizontal Left or Right) R-410A Refrigerant**

Model Number	Nom. Cap. Cooling (Btuh)	Coil Type	Refrigerant Control	Outlet Dim. (in.) W/H x D	Overall Dim. (in.) H x W x D	Shipping Weight (lbs.)	Line Size OD Gas	Line Size OD Liq.
4TXCA018BC3HCB	18,000	A	TXVNB①	12 <sup>5</sup> / <sub>8</sub> x 19 <sup>3</sup> / <sub>8</sub>	22.6 x 14.5 x 21.5	34	5/8	5/16
4TXCA024BC3HCB	24,000	A	TXVNB①	12 <sup>5</sup> / <sub>8</sub> x 19 <sup>3</sup> / <sub>8</sub>	22.6 x 14.5 x 21.5	34	5/8	5/16
4TXCB025BC3HCB	24,000	A	TXVNB①	15 <sup>5</sup> / <sub>8</sub> x 19 <sup>3</sup> / <sub>8</sub>	17.6 x 17.5 x 21.5	38	5/8	5/16
4TXCB031BC3HCB	30,000	A	TXVNB①	15 <sup>5</sup> / <sub>8</sub> x 19 <sup>3</sup> / <sub>8</sub>	17.6 x 17.5 x 21.5	38	5/8	5/16
4TXCB032BC3HCB	36,000	A	TXVNB①	15 <sup>5</sup> / <sub>8</sub> x 19 <sup>3</sup> / <sub>8</sub>	22.6 x 17.5 x 21.5	45	3/4	3/8
4TXCB036BC3HCB	36,000	A	TXVNB①	15 <sup>5</sup> / <sub>8</sub> x 19 <sup>3</sup> / <sub>8</sub>	22.6 x 17.5 x 21.5	45	3/4	3/8
4TXCC037BC3HCB	37,000	A	TXVNB①	19 <sup>1</sup> / <sub>8</sub> x 19 <sup>3</sup> / <sub>8</sub>	22.6 x 21 x 21.5	48	3/4	3/8
4TXCB042BC3HCB	42,000	A	TXVNB①	15 <sup>5</sup> / <sub>8</sub> x 19 <sup>3</sup> / <sub>8</sub>	22.6 x 17.5 x 21.5	45	3/4	3/8
4TXCC043BC3HCB	43,000	A	TXVNB①	19 <sup>1</sup> / <sub>8</sub> x 19 <sup>3</sup> / <sub>8</sub>	22.6 x 21 x 21.5	48	3/4	3/8
4TXCC044BC3HCB	48,000	A	TXVNB①	19 <sup>1</sup> / <sub>8</sub> x 19 <sup>3</sup> / <sub>8</sub>	26.9 x 21 x 21.5	49	7/8	3/8
4TXCB048BC3HCB	48,000	A	TXVNB①	15 <sup>5</sup> / <sub>8</sub> x 19 <sup>3</sup> / <sub>8</sub>	26.9 x 17.5 x 21.5	49	7/8	3/8
4TXCC049BC3HCB	48,000	A	TXVNB①	19 <sup>1</sup> / <sub>8</sub> x 19 <sup>3</sup> / <sub>8</sub>	26.9 x 21 x 21.5	51	7/8	3/8
4TXCD050BC3HCB	48,000	A	TXVNB①	22 <sup>5</sup> / <sub>8</sub> x 19 <sup>3</sup> / <sub>8</sub>	26.9 x 24.6 x 21.5	55	7/8	3/8
4TXCC060BC3HCC	60,000	A	TXVNB①	19 <sup>1</sup> / <sub>8</sub> x 19 <sup>3</sup> / <sub>8</sub>	30.7 x 21 x 21.5	65	7/8	3/8
4TXCD061BC3HCC	60,000	A	TXVNB①	22 <sup>5</sup> / <sub>8</sub> x 19 <sup>3</sup> / <sub>8</sub>	30.7 x 24.6 x 21.5	68	7/8	3/8
4TXCD063BC3HCC	60,000	A	TXVNB①	22 <sup>5</sup> / <sub>8</sub> x 19 <sup>3</sup> / <sub>8</sub>	30.7 x 24.6 x 21.5	68	7/8	3/8
4TXCD064BC3HCC	60,000	A	TXVNB①	22 <sup>5</sup> / <sub>8</sub> x 19 <sup>3</sup> / <sub>8</sub>	30.7 x 24.6 x 21.5	68	7/8	3/8

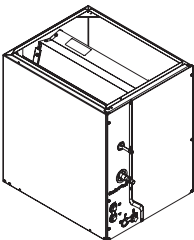

**4NXC-AS  
Comfort™ Coil**

**Table COIL-1-D — Aluminum High Efficiency Staged System Cased Coil Convertible (Downflow/ Horizontal Right Only) R-410A Refrigerant**

Model Number	Nom. Cap. Cooling (Btuh)	Coil Type	Refrigerant Control	Outlet Dim. (in.) W/H x D	Overall Dim. (in.) H x W x D	Shipping Weight (lbs.)	Line Size OD Gas	Line Size OD Liq.
4NXC003AS3HRA	24,000	A	TXVNB①	15 <sup>3</sup> / <sub>4</sub> x 19 <sup>3</sup> / <sub>8</sub>	22.5 x 17.5 x 21.5	54	3/4	3/8
4NXC004AS3HRA	36,000	A	TXVNB①	15 <sup>3</sup> / <sub>4</sub> x 19 <sup>3</sup> / <sub>8</sub>	26.8 x 17.5 x 21.5	63	3/4	3/8
4NXCC005AS3HRA	36,000	A	TXVNB①	19 <sup>1</sup> / <sub>4</sub> x 19 <sup>3</sup> / <sub>8</sub>	26.8 x 21.0 x 21.5	68	3/4	3/8
4NXCC008AS3HRB	48,000	A	TXVNB①	19 <sup>1</sup> / <sub>4</sub> x 19 <sup>3</sup> / <sub>8</sub>	30.7 x 21.0 x 21.5	72	3/4	3/8
4NXCD009AS3HRB	60,000	A	TXVNB①	22 <sup>3</sup> / <sub>4</sub> x 19 <sup>3</sup> / <sub>8</sub>	30.7 x 24.5 x 21.5	82	7/8	3/8

① Start Kit may be required on outdoor unit.



# Split System – Cased Heat Pump and Cooling Coils

Coils

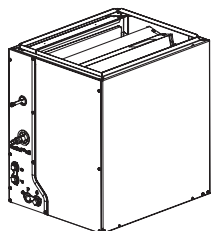

**4NXC-AC  
Comfort™ Coil**

**Table COIL-2-A — Aluminum Cased Coil Convertible (Upflow/ Downflow/ Horizontal Left or Right) R-410A Refrigerant**

Model Number	Nom. Cap. Cooling (Btuh)	Coil Type	Refrigerant Control	Outlet Dim. (in.) W/H x D	Overall Dim. (in.) H x W x D	Shipping Weight (lbs.)	Line Size OD Gas	Line Size OD Liq.
4NXCA024AC3HCA	24,000	A	TXVNB①	12 <sup>5</sup> / <sub>8</sub> x 19 <sup>3</sup> / <sub>8</sub>	17.6 x 14.5 x 21.5	34	3/4	3/8
4NXCB025AC3HCA	24,000	A	TXVNB①	15 <sup>5</sup> / <sub>8</sub> x 19 <sup>3</sup> / <sub>8</sub>	18.4 x 17.5 x 21.5	38	3/4	3/8
4NXCB031AC3HCA	30,000	A	TXVNB①	15 <sup>5</sup> / <sub>8</sub> x 19 <sup>3</sup> / <sub>8</sub>	18.4 x 17.5 x 21.5	38	3/4	3/8
4NXCB032AC3HCA	30,000	A	TXVNB①	15 <sup>5</sup> / <sub>8</sub> x 19 <sup>3</sup> / <sub>8</sub>	22.6 x 17.5 x 21.5	45	3/4	3/8
4NXCB036AC3HCA	36,000	A	TXVNB①	15 <sup>5</sup> / <sub>8</sub> x 19 <sup>3</sup> / <sub>8</sub>	22.6 x 17.5 x 21.5	45	3/4	3/8
4NXCD063BC3HCB	60,000	A	TXVNB①	22 <sup>5</sup> / <sub>8</sub> x 19 <sup>3</sup> / <sub>8</sub>	30.7 x 24.6 x 21.5	68	7/8	3/8

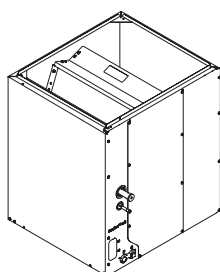

**4PXC-U  
Comfort™ Coil**

**Table COIL-2-B — Aluminum High Efficiency Staged System Cased Coil Dedicated Upflow Coils R-410A Refrigerant, Convertible to Horizontal Left with kit**

Model Number	Nom. Cap. Cooling (Btuh)	Coil Type	Refrigerant Control	Outlet Dim. (in.) W/H x D	Overall Dim. (in.) H x W x D	Shipping Weight (lbs.)	Line Size OD Gas	Line Size OD Liq.
4PXCAU24BS3HAA	24,000	A	TXVNB①	12 <sup>3</sup> / <sub>4</sub> x 19 <sup>3</sup> / <sub>8</sub>	17.5 x 14.5 x 21.5	39	3/4	3/8
4PXCBU24BS3HAA	24,000	A	TXVNB①	15 <sup>3</sup> / <sub>4</sub> x 19 <sup>3</sup> / <sub>8</sub>	17.5 x 17.5 x 21.5	42	3/4	3/8
4PXCBU30BS3HAA	30,000	A	TXVNB①	15 <sup>3</sup> / <sub>4</sub> x 19 <sup>3</sup> / <sub>8</sub>	17.5 x 17.5 x 21.5	47	3/4	3/8
4PXCCU30BS3HAA	30,000	A	TXVNB①	19 <sup>1</sup> / <sub>4</sub> x 19 <sup>3</sup> / <sub>8</sub>	17.5 x 21 x 21.5	49	3/4	3/8
4PXCBU36BS3HAA	36,000	A	TXVNB①	15 <sup>3</sup> / <sub>4</sub> x 19 <sup>3</sup> / <sub>8</sub>	22.5 x 17.5 x 21.5	54	7/8	3/8
4PXCCU36BS3HAA	36,000	A	TXVNB①	19 <sup>1</sup> / <sub>4</sub> x 19 <sup>3</sup> / <sub>8</sub>	22.5 x 21 x 21.5	56	7/8	3/8
4PXCBU42BS3HAA	42,000	A	TXVNB①	15 <sup>3</sup> / <sub>4</sub> x 19 <sup>3</sup> / <sub>8</sub>	26.9 x 17.5 x 21.5	61	7/8	3/8
4PXCCU42BS3HAA	42,000	A	TXVNB①	19 <sup>1</sup> / <sub>4</sub> x 19 <sup>3</sup> / <sub>8</sub>	26.9 x 21 x 21.5	64	7/8	3/8
4PXCBU48BS3HAA	48,000	A	TXVNB①	15 <sup>3</sup> / <sub>4</sub> x 19 <sup>3</sup> / <sub>8</sub>	26.9 x 17.5 x 21.5	61	7/8	3/8
4PXCCU48BS3HAA	48,000	A	TXVNB①	19 <sup>1</sup> / <sub>4</sub> x 19 <sup>3</sup> / <sub>8</sub>	26.9 x 21 x 21.5	64	7/8	3/8
4PXCDU48BS3HAA	48,000	A	TXVNB①	22 <sup>3</sup> / <sub>4</sub> x 19 <sup>3</sup> / <sub>8</sub>	26.9 x 24.5 x 21.5	68	7/8	3/8
4PXCCU60BS3HAA	60,000	A	TXVNB①	19 <sup>1</sup> / <sub>4</sub> x 19 <sup>3</sup> / <sub>8</sub>	30.7 x 21 x 21.5	73	7/8	3/8
4PXCDU60BS3HAA	60,000	A	TXVNB①	22 <sup>3</sup> / <sub>4</sub> x 19 <sup>3</sup> / <sub>8</sub>	30.7 x 24.5 x 21.5	77	7/8	3/8

**Table COIL-2-C — Aluminum High Efficiency Staged System Cased Coil Dedicated Upflow Coils R-410A Refrigerant, Convertible to Horizontal Left with kit**

Model Number	Nom. Cap. Cooling (Btuh)	Coil Type	Refrigerant Control	Outlet Dim. (in.) W/H x D	Overall Dim. (in.) H x W x D	Shipping Weight (lbs.)	Line Size OD Gas	Line Size OD Liq.
4PXCAU18AC3HAA	18,000	A	TXVNB①	12 <sup>3</sup> / <sub>4</sub> x 19 <sup>3</sup> / <sub>8</sub>	17.5 x 14.5 x 21.5	39	3/4	3/8
4PXCBU18AC3HAA	18,000	A	TXVNB①	15 <sup>3</sup> / <sub>4</sub> x 19 <sup>3</sup> / <sub>8</sub>	17.5 x 17.5 x 21.5	42	3/4	3/8
4PXCAU24AC3HAA	24,000	A	TXVNB①	12 <sup>3</sup> / <sub>4</sub> x 19 <sup>3</sup> / <sub>8</sub>	17.5 x 14.5 x 21.5	39	3/4	3/8
4PXCBU24AC3HAA	24,000	A	TXVNB①	15 <sup>3</sup> / <sub>4</sub> x 19 <sup>3</sup> / <sub>8</sub>	17.5 x 17.5 x 21.5	42	3/4	3/8
4PXCBU30AC3HAA	30,000	A	TXVNB①	15 <sup>3</sup> / <sub>4</sub> x 19 <sup>3</sup> / <sub>8</sub>	17.5 x 17.5 x 21.5	47	3/4	3/8
4PXCCU30AC3HAA	30,000	A	TXVNB①	19 <sup>1</sup> / <sub>4</sub> x 19 <sup>3</sup> / <sub>8</sub>	17.5 x 21 x 21.5	49	3/4	3/8
4PXCBU36AC3HAA	36,000	A	TXVNB①	15 <sup>3</sup> / <sub>4</sub> x 19 <sup>3</sup> / <sub>8</sub>	22.5 x 17.5 x 21.5	54	7/8	3/8
4PXCCU36AC3HAA	36,000	A	TXVNB①	19 <sup>1</sup> / <sub>4</sub> x 19 <sup>3</sup> / <sub>8</sub>	22.5 x 21 x 21.5	56	7/8	3/8
4PXCBU42AC3HAA	42,000	A	TXVNB①	15 <sup>3</sup> / <sub>4</sub> x 19 <sup>3</sup> / <sub>8</sub>	26.9 x 17.5 x 21.5	61	7/8	3/8
4PXCCU42AC3HAA	42,000	A	TXVNB①	19 <sup>1</sup> / <sub>4</sub> x 19 <sup>3</sup> / <sub>8</sub>	26.9 x 21 x 21.5	64	7/8	3/8
4PXCBU48AC3HAA	48,000	A	TXVNB①	15 <sup>3</sup> / <sub>4</sub> x 19 <sup>3</sup> / <sub>8</sub>	26.9 x 17.5 x 21.5	61	7/8	3/8
4PXCCU48AC3HAA	48,000	A	TXVNB①	19 <sup>1</sup> / <sub>4</sub> x 19 <sup>3</sup> / <sub>8</sub>	26.9 x 21 x 21.5	64	7/8	3/8
4PXCDU48AC3HAA	48,000	A	TXVNB①	22 <sup>3</sup> / <sub>4</sub> x 19 <sup>3</sup> / <sub>8</sub>	26.9 x 24.5 x 21.5	68	7/8	3/8
4PXCCU60AC3HAA	60,000	A	TXVNB①	19 <sup>1</sup> / <sub>4</sub> x 19 <sup>3</sup> / <sub>8</sub>	30.7 x 21 x 21.5	73	7/8	3/8
4PXCDU60AC3HAA	60,000	A	TXVNB①	22 <sup>3</sup> / <sub>4</sub> x 19 <sup>3</sup> / <sub>8</sub>	30.7 x 24.5 x 21.5	77	7/8	3/8

① Start Kit may be required on outdoor unit.

# Split System – Cased Heat Pump and Cooling Coils

Coils

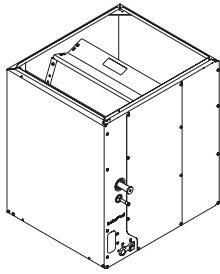

**4PXC-D  
Comfort™ Coil**

**Table COIL-3-A — Aluminum High Efficiency Staged System Cased Coil Dedicated Downflow Coils R-410A Refrigerant, Convertible to Horizontal Right with kit**

Model Number	Nom. Cap. Cooling (Btuh)	Coil Type	Refrigerant Control	Outlet Dim. (in.) W/H x D	Overall Dim. (in.) H x W x D	Shipping Weight (lbs.)	Line Size OD Gas	Line Size OD Liq.
4PXCAD24BS3HDA	24,000	A	TXVNB①	12 <sup>3</sup> / <sub>4</sub> x 19 <sup>3</sup> / <sub>8</sub>	17.5 x 14.5 x 21.5	39	3/4	3/8
4PXCBD24BS3HDA	24,000	A	TXVNB①	15 <sup>3</sup> / <sub>4</sub> x 19 <sup>3</sup> / <sub>8</sub>	17.5 x 17.5 x 21.5	42	3/4	3/8
4PXCBD30BS3HDA	30,000	A	TXVNB①	15 <sup>3</sup> / <sub>4</sub> x 19 <sup>3</sup> / <sub>8</sub>	17.5 x 17.5 x 21.5	47	3/4	3/8
4PXCCD30BS3HDA	30,000	A	TXVNB①	19 <sup>1</sup> / <sub>4</sub> x 19 <sup>3</sup> / <sub>8</sub>	17.5 x 21 x 21.5	49	3/4	3/8
4PXCBD36BS3HDA	36,000	A	TXVNB①	15 <sup>3</sup> / <sub>4</sub> x 19 <sup>3</sup> / <sub>8</sub>	22.5 x 17.5 x 21.5	54	7/8	3/8
4PXCCD36BS3HDA	36,000	A	TXVNB①	19 <sup>1</sup> / <sub>4</sub> x 19 <sup>3</sup> / <sub>8</sub>	22.5 x 21 x 21.5	56	7/8	3/8
4PXCBD42BS3HDA	42,000	A	TXVNB①	15 <sup>3</sup> / <sub>4</sub> x 19 <sup>3</sup> / <sub>8</sub>	26.9 x 17.5 x 21.5	61	7/8	3/8
4PXCCD42BS3HDA	42,000	A	TXVNB①	19 <sup>1</sup> / <sub>4</sub> x 19 <sup>3</sup> / <sub>8</sub>	26.9 x 21 x 21.5	64	7/8	3/8
4PXCBD48BS3HDA	48,000	A	TXVNB①	15 <sup>3</sup> / <sub>4</sub> x 19 <sup>3</sup> / <sub>8</sub>	26.9 x 17.5 x 21.5	61	7/8	3/8
4PXCCD48BS3HDA	48,000	A	TXVNB①	19 <sup>1</sup> / <sub>4</sub> x 19 <sup>3</sup> / <sub>8</sub>	26.9 x 21 x 21.5	64	7/8	3/8
4PXCDD48BS3HDA	48,000	A	TXVNB①	22 <sup>3</sup> / <sub>4</sub> x 19 <sup>3</sup> / <sub>8</sub>	26.9 x 24.5 x 21.5	68	7/8	3/8
4PXCCD60BS3HDA	60,000	A	TXVNB①	19 <sup>1</sup> / <sub>4</sub> x 19 <sup>3</sup> / <sub>8</sub>	30.7 x 21 x 21.5	73	7/8	3/8
4PXCDD60BS3HDA	60,000	A	TXVNB①	22 <sup>3</sup> / <sub>4</sub> x 19 <sup>3</sup> / <sub>8</sub>	30.7 x 24.5 x 21.5	77	7/8	3/8

**Table COIL-3-B — Aluminum High Efficiency Staged System Cased Coil Dedicated Downflow Coils R-410A Refrigerant, Convertible to Horizontal Right with kit**

Model Number	Nom. Cap. Cooling (Btuh)	Coil Type	Refrigerant Control	Outlet Dim. (in.) W/H x D	Overall Dim. (in.) H x W x D	Shipping Weight (lbs.)	Line Size OD Gas	Line Size OD Liq.
4PXCAD18AC3HDA	18,000	A	TXVNB①	12 <sup>3</sup> / <sub>4</sub> x 19 <sup>3</sup> / <sub>8</sub>	17.5 x 14.5 x 21.5	39	3/4	3/8
4PXCBD18AC3HDA	18,000	A	TXVNB①	15 <sup>3</sup> / <sub>4</sub> x 19 <sup>3</sup> / <sub>8</sub>	17.5 x 17.5 x 21.5	42	3/4	3/8
4PXCAD24AC3HDA	24,000	A	TXVNB①	12 <sup>3</sup> / <sub>4</sub> x 19 <sup>3</sup> / <sub>8</sub>	17.5 x 14.5 x 21.5	39	3/4	3/8
4PXCBD24AC3HDA	24,000	A	TXVNB①	15 <sup>3</sup> / <sub>4</sub> x 19 <sup>3</sup> / <sub>8</sub>	17.5 x 17.5 x 21.5	42	3/4	3/8
4PXCBD30AC3HDA	30,000	A	TXVNB①	15 <sup>3</sup> / <sub>4</sub> x 19 <sup>3</sup> / <sub>8</sub>	17.5 x 17.5 x 21.5	47	3/4	3/8
4PXCCD30AC3HDA	30,000	A	TXVNB①	19 <sup>1</sup> / <sub>4</sub> x 19 <sup>3</sup> / <sub>8</sub>	17.5 x 21 x 21.5	49	3/4	3/8
4PXCBD36AC3HDA	36,000	A	TXVNB①	15 <sup>3</sup> / <sub>4</sub> x 19 <sup>3</sup> / <sub>8</sub>	22.5 x 17.5 x 21.5	54	7/8	3/8
4PXCCD36AC3HDA	36,000	A	TXVNB①	19 <sup>1</sup> / <sub>4</sub> x 19 <sup>3</sup> / <sub>8</sub>	22.5 x 21 x 21.5	56	7/8	3/8
4PXCBD42AC3HDA	42,000	A	TXVNB①	15 <sup>3</sup> / <sub>4</sub> x 19 <sup>3</sup> / <sub>8</sub>	26.9 x 17.5 x 21.5	61	7/8	3/8
4PXCCD42AC3HDA	42,000	A	TXVNB①	19 <sup>1</sup> / <sub>4</sub> x 19 <sup>3</sup> / <sub>8</sub>	26.9 x 21 x 21.5	64	7/8	3/8
4PXCBD48AC3HDA	48,000	A	TXVNB①	15 <sup>3</sup> / <sub>4</sub> x 19 <sup>3</sup> / <sub>8</sub>	26.9 x 17.5 x 21.5	61	7/8	3/8
4PXCCD48AC3HDA	48,000	A	TXVNB①	19 <sup>1</sup> / <sub>4</sub> x 19 <sup>3</sup> / <sub>8</sub>	26.9 x 21 x 21.5	64	7/8	3/8
4PXCDD48AC3HDA	48,000	A	TXVNB①	22 <sup>3</sup> / <sub>4</sub> x 19 <sup>3</sup> / <sub>8</sub>	26.9 x 24.5 x 21.5	68	7/8	3/8
4PXCCD60AC3HDA	60,000	A	TXVNB①	19 <sup>1</sup> / <sub>4</sub> x 19 <sup>3</sup> / <sub>8</sub>	30.7 x 21 x 21.5	73	7/8	3/8
4PXCDD60AC3HDA	60,000	A	TXVNB①	22 <sup>3</sup> / <sub>4</sub> x 19 <sup>3</sup> / <sub>8</sub>	30.7 x 24.5 x 21.5	77	7/8	3/8

① Start Kit may be required on outdoor unit.

**Table COIL-3-C - Horizontal Conversion Kits for 4PXC Coils**

Horizontal Kit No.	Used with Model Number
BAYCONV18A	4PXCAU24, 4PXCBU24, 4PXCUB30, 4PXCCU30, 4PXCAD24, 4PXCBD24, 4PXCBD30, 4PXCCD30
BAYCONV23A	4PXCBU36, 4PXCCU36, 4PXCBD36, 4PXCCD36
BAYCONV27A	4PXCBU42, 4PXCCU42, 4PXCUB48, 4PXCCU48, 4PXCUB48, 4PXCBD42, 4PXCCD42, 4PXCBD48, 4PXCCD48, 4PXCDD48
BAYCONV30A	4PXCCU60, 4PXCUB60, 4PXCCD60, 4PXCDD60

**Table COIL-3-D - R-22 TXV Conversion TXV Kits for 4PXC, 4PXA, and 4TXC-D Coils**

R-22 TXV Kit	Coil models where used	
2AYTXVH3H1836A	4PX: 24 - 36	4TXC: 002DS - 005DS
2AYTXVH3H4248A	4PX: 42 - 48	4TXC: 006DS - 008DS
2AYTXVH3H6060A	4PX: 60	4TXC: 009DS - 010DS

# Split System – Uncased Heat Pump and Cooling Coils

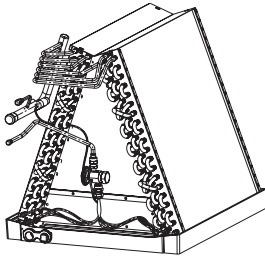

**4TXA-BC  
Comfort™ Coil**

**Table COIL-4-A — Aluminum Uncased Coil (Upflow/Downflow) R-410A Refrigerant**

Model Number	Nom. Cap. Cooling (Btuh)	Coil Type	Refrigerant Control	Overall Dim. (in.) H x W x D	Shipping Weight (lbs.)	Line Size OD Gas	OD Liq.
4TXAA018BC3HUB	18,000	A	TXVNB①	17.4 x 13.3 x 21.1	21	5/8	5/16
4TXAA024BC3HUB	24,000	A	TXVNB①	17.4 x 13.3 x 21.1	21	5/8	5/16
4TXAB025BC3HUB	24,000	A	TXVNB①	15.9 x 16.3 x 21.1	24	5/8	5/16
4TXAB031BC3HUB	30,000	A	TXVNB①	15.9 x 16.3 x 21.1	24	5/8	5/16
4TXAB032BC3HUB	36,000	A	TXVNB①	21.2 x 16.3 x 21.1	32	3/4	3/8
4TXAB036BC3HUB	36,000	A	TXVNB①	21.2 x 16.3 x 21.1	32	3/4	3/8
4TXAC037BC3HUB	36,000	A	TXVNB①	20.8 x 19.8 x 21.1	33	3/4	3/8
4TXAB042BC3HUB	42,000	A	TXVNB①	21.2 x 16.3 x 21.1	32	3/4	3/8
4TXAC043BC3HUB	42,000	A	TXVNB①	20.8 x 19.8 x 21.1	33	3/4	3/8
4TXAC044BC3HUB	48,000	A	TXVNB①	25.3 x 19.8 x 21.1	38	7/8	3/8
4TXAB048BC3HUB	48,000	A	TXVNB①	25.3 x 16.3 x 21.1	36	7/8	3/8
4TXAC049BC3HUB	48,000	A	TXVNB①	24.9 x 19.8 x 21.1	38	7/8	3/8
4TXAD050BC3HUB	48,000	A	TXVNB①	24.4 x 23.3 x 21.1	39	7/8	3/8
4TXAC060BC3HUB	60,000	A	TXVNB①	29.1 x 19.8 x 21.1	44	7/8	3/8
4TXAD061BC3HUB	60,000	A	TXVNB①	28.6 x 23.3 x 21.1	45	7/8	3/8
4TXAD064BC3HUB	60,000	A	TXVNB①	28.6 x 23.3 x 21.1	45	7/8	3/8

**Table COIL-4-B — 13 SEER Split System - Uncased Coil Enclosures**

Model Number	Coils	Used With Furnaces Flush on Both Sides	Dimensions (in.) H x W x D	Shipping Weight (lbs.)
BAYCLE14A1422A	4TXAA018BC, 4PXAAU24BS 4TXAA024BC	14½" Wide Furnace	22½ x 14½ x 21½	12
BAYCLE17A1722A	4TXAB025AS, 4PXABU24BS 4TXAB031AS, 4PXABU30BS 4TXAB036AS, 4PXABU36BS 4TXAB025BC, 4PXABU42BS 4TXAB031BC, 4PXABU48BS 4TXAB032BC 4TXAB036BC 4TXAB042BC 4TXAB048BC	17½" Wide Furnace	22⅝ x 17½ x 21½	14
BAYCLE21A2130A	4TXAC037AS, 4PXACU30BS 4TXAC054AS, 4PXACU36BS 4TXAC037BC, 4PXACU42BS 4TXAC043BC, 4PXACU48BS 4TXAC044BC, 4PXACU60BS 4TXAC049BC 4TXAC060BC	21" Wide Furnace	30 x 21 x 21½	18
BAYCLE24A2430A	4TXAD065AS, 4PXADU48BS 4TXAD050BC, 4PXADU60BS 4TXAD061BC 4TXAD064BC	24½" Wide Furnace	30 x 24½ x 21½	22

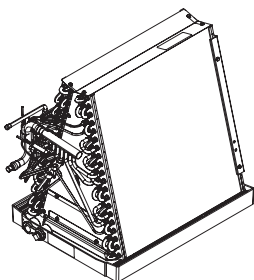

**4NXA-AC**

**Table COIL-4-C — Aluminum Uncased Coil (Upflow/Downflow) R-410A Refrigerant**

Model Number	Nom. Cap. Cooling (Btuh)	Coil Type	Refrigerant Control	Overall Dim. (in.) H x W x D	Shipping Weight (lbs.)	Line Size OD Gas	OD Liq.
4NXAA018AC3HUA	18,000	A	TXVNB①	15.2 x 13.3 x 21.1	24	3/4	3/8
4NXAA024AC3HUA	24,000	A	TXVNB①	15.2 x 13.3 x 21.1	24	3/4	3/8
4NXAB025AC3HUA	24,000	A	TXVNB①	16.9 x 16.3 x 21.1	25	3/4	3/8
4NXAB031AC3HUA	30,000	A	TXVNB①	16.9 x 16.3 x 21.1	25	3/4	3/8
4NXAB032AC3HUA	30,000	A	TXVNB①	21.0 x 16.3 x 21.1	27	3/4	3/8
4NXAB036AC3HUA	36,000	A	TXVNB①	21.0 x 16.3 x 21.1	27	3/4	3/8

① Start Kit may be required on outdoor unit.

# Split System – Uncased Heat Pump and Cooling Coils

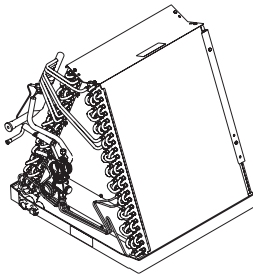

**4PXA-U  
Comfort™ Coil**

**Table COIL-5-A — Aluminum Uncased Upflow Coil R-410A Refrigerant**

Model Number	Nom. Cap. Cooling (Btuh)	Coil Type	Refrigerant Control	Overall Dim. (in.) H x W x D	Shipping Weight (lbs.)	Line Size	
						OD Gas	OD Liq.
4PXA AU24BS3HAA	24,000	A	TXVNB①	14.7 x 13.3 x 21.1	24	3/4	3/8
4PXABU24BS3HAA	24,000	A	TXVNB①	14.5 x 16.3 x 21.1	24	3/4	3/8
4PXABU30BS3HAA	30,000	A	TXVNB①	15.8 x 16.3 x 21.1	32	3/4	3/8
4PXACU30BS3HAA	30,000	A	TXVNB①	15.8 x 19.8 x 21.1	32	3/4	3/8
4PXABU36BS3HAA	36,000	A	TXVNB①	21.2 x 16.3 x 21.1	33	7/8	3/8
4PXACU36BS3HAA	36,000	A	TXVNB①	20.8 x 19.8 x 21.1	32	7/8	3/8
4PXABU42BS3HAA	42,000	A	TXVNB①	23.8 x 16.3 x 21.1	33	7/8	3/8
4PXACU42BS3HAA	42,000	A	TXVNB①	23.7 x 19.8 x 21.1	38	7/8	3/8
4PXABU48BS3HAA	48,000	A	TXVNB①	25.3 x 16.3 x 21.1	36	7/8	3/8
4PXACU48BS3HAA	48,000	A	TXVNB①	24.9 x 19.8 x 21.1	38	7/8	3/8
4PXADU48BS3HAA	48,000	A	TXVNB①	24.5 x 23.3 x 21.1	39	7/8	3/8
4PXACU60BS3HAA	60,000	A	TXVNB①	29.2 x 19.8 x 21.1	44	7/8	3/8
4PXADU60BS3HAA	60,000	A	TXVNB①	28.5 x 23.3 x 21.1	45	7/8	3/8

**Table COIL-5-B — Aluminum Uncased Upflow Coil R-410A Refrigerant**

Model Number	Nom. Cap. Cooling (Btuh)	Coil Type	Refrigerant Control	Overall Dim. (in.) H x W x D	Shipping Weight (lbs.)	Line Size	
						OD Gas	OD Liq.
4PXA AU18AC3HAA	18,000	A	TXVNB①	14.7 x 13.3 x 21.1	21	3/4	3/8
4PXABU18AC3HAA	18,000	A	TXVNB①	14.5 x 16.3 x 21.1	21	3/4	3/8
4PXA AU24AC3HAA	24,000	A	TXVNB①	14.7 x 13.3 x 21.1	24	3/4	3/8
4PXABU24AC3HAA	24,000	A	TXVNB①	14.5 x 16.3 x 21.1	24	3/4	3/8
4PXABU30AC3HAA	30,000	A	TXVNB①	15.8 x 16.3 x 21.1	32	3/4	3/8
4PXACU30AC3HAA	30,000	A	TXVNB①	15.8 x 19.8 x 21.1	32	3/4	3/8
4PXABU36AC3HAA	36,000	A	TXVNB①	21.2 x 16.3 x 21.1	33	7/8	3/8
4PXACU36AC3HAA	36,000	A	TXVNB①	20.8 x 19.8 x 21.1	32	7/8	3/8
4PXABU42AC3HAA	42,000	A	TXVNB①	23.8 x 16.3 x 21.1	33	7/8	3/8
4PXACU42AC3HAA	42,000	A	TXVNB①	23.7 x 19.8 x 21.1	38	7/8	3/8
4PXABU48AC3HAA	48,000	A	TXVNB①	25.3 x 16.3 x 21.1	36	7/8	3/8
4PXACU48AC3HAA	48,000	A	TXVNB①	24.9 x 19.8 x 21.1	38	7/8	3/8
4PXADU48AC3HAA	48,000	A	TXVNB①	24.5 x 23.3 x 21.1	39	7/8	3/8
4PXACU60AC3HAA	60,000	A	TXVNB①	29.2 x 19.8 x 21.1	44	7/8	3/8
4PXADU60AC3HAA	60,000	A	TXVNB①	28.5 x 23.3 x 21.1	45	7/8	3/8

① Start Kit may be required on outdoor unit.

# Split System – Cased Heat Pump and Cooling Coils

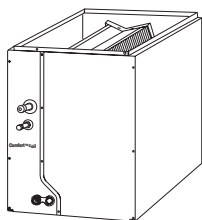

**4CXC-CC  
Comfort™ Coil**

**Table COIL-6-A — Aluminum Cooling ONLY Cased Coils- Upflow R-410A Refrigerant**

Model Number	Nom. Cap. Cooling (Btuh)	Coil Type	Refrigerant Control	Outlet Dim. (in.) H x D	Overall Dim. (in.) H x W x D	Shipping Weight (lbs.)	Line Size OD Gas	Line Size OD Liq.
4CXCA024CC3CUB	24,000	A	TXVNB①	12 <sup>5</sup> / <sub>8</sub> x 19 <sup>3</sup> / <sub>8</sub>	22.6x14.5x21.5	33	5/8	3/8
4CXCB025CC3CUB	24,000	A	TXVNB①	15 <sup>5</sup> / <sub>8</sub> x 19 <sup>3</sup> / <sub>8</sub>	17.6x17.5x21.5	43	3/4	3/8
4CXCB031CC3CUB	30,000	A	TXVNB①	15 <sup>5</sup> / <sub>8</sub> x 19 <sup>3</sup> / <sub>8</sub>	17.6x17.5x21.5	43	3/4	3/8
4CXCB036CC3CUB	36,000	A	TXVNB①	15 <sup>5</sup> / <sub>8</sub> x 19 <sup>3</sup> / <sub>8</sub>	22.6x17.5x21.5	45	3/4	3/8
4CXCC037CC3CUB	37,000	A	TXVNB①	19 <sup>1</sup> / <sub>8</sub> x 19 <sup>3</sup> / <sub>8</sub>	22.6x21x21.5	48	3/4	3/8
4CXCB042CC3CUB	42,000	A	TXVNB①	15 <sup>5</sup> / <sub>8</sub> x 19 <sup>3</sup> / <sub>8</sub>	22.6x17.5x21.5	45	3/4	3/8
4CXCC043CC3CUB	43,000	A	TXVNB①	19 <sup>1</sup> / <sub>8</sub> x 19 <sup>3</sup> / <sub>8</sub>	22.6x21x21.5	48	3/4	3/8
4CXCC049CC3CUB	48,000	A	TXVNB①	19 <sup>1</sup> / <sub>8</sub> x 19 <sup>3</sup> / <sub>8</sub>	26.9x21x21.5	52	7/8	3/8
4CXCD061CC3CUB	60,000	A	TXVNB①	22 <sup>5</sup> / <sub>8</sub> x 19 <sup>3</sup> / <sub>8</sub>	30.7x24.5x21.5	67	7/8	3/8

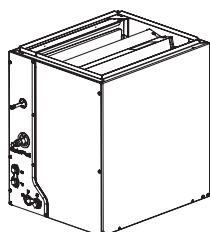

**4CXC-DC  
Comfort™ Coil**

**Table COIL-6-B — Aluminum Cooling ONLY Cased Coils- Upflow R-410A Refrigerant**

Model Number	Nom. Cap. Cooling (Btuh)	Coil Type	Refrigerant Control	Outlet Dim. (in.) W/H x D	Overall Dim. (in.) H x W x D	Shipping Weight (lbs.)	Line Size OD Gas	Line Size OD Liq.
4CXCA018DC3CAA	18,000	A	TXVNB①	12 <sup>5</sup> / <sub>8</sub> x 19 <sup>3</sup> / <sub>8</sub>	17.6 x 14.5 x 21.5	34	3/4	3/8
4CXCA024DC3CAA	24,000	A	TXVNB①	12 <sup>5</sup> / <sub>8</sub> x 19 <sup>3</sup> / <sub>8</sub>	17.6 x 14.5 x 21.5	34	3/4	3/8
4CXCB025DC3CAA	24,000	A	TXVNB①	15 <sup>5</sup> / <sub>8</sub> x 19 <sup>3</sup> / <sub>8</sub>	18.4 x 17.5 x 21.5	38	3/4	3/8
4CXCB031DC3CAA	30,000	A	TXVNB①	15 <sup>5</sup> / <sub>8</sub> x 19 <sup>3</sup> / <sub>8</sub>	18.4 x 17.5 x 21.5	38	3/4	3/8
4CXCB032DC3CAA	30,000	A	TXVNB①	15 <sup>5</sup> / <sub>8</sub> x 19 <sup>3</sup> / <sub>8</sub>	22.6 x 17.5 x 21.5	45	3/4	3/8
4CXCB036DC3CAA	36,000	A	TXVNB①	15 <sup>5</sup> / <sub>8</sub> x 19 <sup>3</sup> / <sub>8</sub>	22.6 x 17.5 x 21.5	45	3/4	3/8

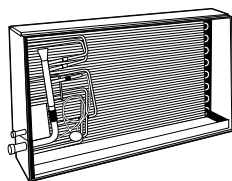

**4TXF**

**Table COIL-6-C — Aluminum Cased Horizontal Flat Coils R-410A Refrigerant**

Model Number	Nom. Cap. Cooling (Btuh)	Coil Type	Refrigerant Control	Outlet Dim. (in.) H x D	Overall Dim. (in.) H x W x D	Shipping Weight (lbs.)	Line Size OD Gas	Line Size OD Liq.
4TXFH024CZ3HHB	24,000	Flat	TXVNB①	21 x 33 <sup>1</sup> / <sub>4</sub>	22.7 x 10.2 x 37.5	48	5/8	3/8
4TXFH033CC3HHB	34,000	Flat	TXVNB①	21 x 24	22.7 x 10.2 x 28.2	49	3/4	5/16
4TXFH036CZ3HHB	36,000	Flat	TXVNB①	21 x 33 <sup>1</sup> / <sub>4</sub>	22.7 x 10.2 x 37.5	53	3/4	3/8
4TXFH041CC3HHB	44,000	Flat	TXVNB①	21 x 33 <sup>1</sup> / <sub>4</sub>	22.7 x 10.2 x 37.5	57	3/4	3/8
4TXFH054CC3HHB	58,000	Flat	TXVNB①	21 x 33 <sup>1</sup> / <sub>4</sub>	22.7 x 10.2 x 37.5	55	7/8	3/8
4TXFH063CZ3HHB	61,000	Flat	TXVNB①	27 x 33 <sup>1</sup> / <sub>4</sub>	28.7 x 10.2 x 37.5	63	7/8	3/8
4TXFH064AZ3HHA	61,000	Flat	TXVNB①	27 x 33 <sup>1</sup> / <sub>4</sub>	28.6 x 10.2 x 37.5	63	7/8	3/8

① Start Kit may be required on outdoor unit.

# Split System – Cased/Uncased Heat Pump and Cooling Coils

**Table COIL-7-A — Features**

	4TXC-CC	4TXC-BC	4TXA-BC	4CXC-CC	4TXF	
• All aluminum coil .....	✓	✓	PHASING OUT	✓	✓	
• 100% foil lined insulation.....	✓	✓		✓	✓	
• Internally checked non-bleed* thermal expansion valve with mechanical fittings (heat pump operation).....	✓	✓		✓	—	✓
• Non-Bleed* thermal expansion valve with mechanical fittings (cooling only operation) .....	—	—		—	—	—
• Easy case attachment to furnace.....	✓	✓		✓	✓	—
• Upflow only application .....	—	—		✓	✓	—
• Upflow/Downflow application .....	—	—		—	—	—
• 4 way application - Upflow/Downflow/Horizontal (left/right) .....	✓	✓		—	—	—
• Horizontal application with Bi-Direction airflow .....	✓	✓		—	—	✓
• Double sloped non-corrosive drain pan - UL rated 400°F.....	✓	✓		✓	✓	—
• Sloped non-corrosive drain pan .....	—	—		—	—	✓
• Optimized for high efficiency with staged systems .....	✓	—		—	—	—
• Split inner and outer doors for easy coil inspection and cleaning.....	✓	✓		—	—	—
• Painted galvanized steel cabinet to match furnace.....	✓	✓		✓	✓	—
• Unpainted galvanized steel cabinet .....	—	—		—	—	✓
• <b>10-year registered limited warranty on coil, &amp; all other functional parts (Residential Use)**</b> .....	✓	✓		✓	✓	✓

\*Start kit may be required on outdoor unit.

\*\*Registered Limited Warranty terms are available when you register within 60 days of installation. You can register online at [americanstandardair.com](http://americanstandardair.com) or by phone at 800-554-8005; otherwise American Standard Heating & Air Conditioning's Base Limited Warranty terms will apply. Base Limited Warranty information on specific products can be found on ASDealerNet.com.

**Table COIL-7-B — Features - Enhanced Fin Models**

	4TXC-DS	4NXC-AS	4NXC-AC	4NXA-AC	4CXC-DC	
• All aluminum coil .....	✓	✓	PHASING OUT	✓	✓	
• Enhanced Fin Surface.....	✓	✓		✓	✓	✓
• 100% foil lined insulation.....	✓	✓		✓	—	✓
• Internally checked non-bleed* thermal expansion valve with mechanical fitting on distributor side, brazed on liquid side (heat pump operation) .....	✓	✓		✓	✓	—
• Non-Bleed* thermal expansion valve with mechanical fitting on distributor side, brazed on liquid side (cooling only operation).....	—	—		—	—	✓
• Easy case attachment to furnace.....	✓	✓		—	—	✓
• Upflow only application .....	—	—		—	—	✓
• Downflow/Horizontal Right only application .....	—	✓		—	—	—
• Upflow/Downflow application .....	—	—		—	✓	—
• 4 way application - Upflow/Downflow/Horizontal (left/right) .....	✓	—		✓	—	—
• Double sloped non-corrosive drain pan - UL rated 400°F.....	✓	✓		✓	—	✓
• Optimized for high efficiency with staged systems .....	✓	✓		—	—	✓
• Split inner and outer doors for easy coil inspection and cleaning.....	✓	✓		—	—	✓
• Painted galvanized steel cabinet to match furnace.....	✓	✓		—	—	✓
• <b>10-year registered limited warranty on coil, &amp; all other functional parts (Residential Use)**</b> .....	✓	✓		✓	✓	✓

\*Start kit may be required on outdoor unit.

\*\*Registered Limited Warranty terms are available when you register within 60 days of installation. You can register online at [americanstandardair.com](http://americanstandardair.com) or by phone at 800-554-8005; otherwise American Standard Heating & Air Conditioning's Base Limited Warranty terms will apply. Base Limited Warranty information on specific products can be found on ASDealerNet.com.

**Table COIL-7-C — Features - Enhanced Fin Models**

	4PXC-U	4PXC-D	4PXA-U
• All aluminum coil .....	✓	✓	✓
• Enhanced Fin Surface.....	✓	✓	✓
• 100% foil lined insulation.....	✓	✓	—
• Internally checked non-bleed* thermal expansion valve with mechanical fitting on both sides (heat pump operation) .....	✓	✓	✓
• Easy case attachment to furnace.....	✓	✓	—
• Upflow only application .....	—	—	✓
• Upflow application; convertible to Horizontal Left application with kit .....	✓	—	—
• Downflow application; convertible to Horizontal Right application with kit.....	—	✓	—
• Double sloped non-corrosive drain pan - UL rated 400°F.....	✓	✓	✓
• Optimized for high efficiency .....	✓	✓	✓
• Split inner and outer doors for easy coil inspection and cleaning.....	✓	✓	—
• Painted galvanized steel cabinet to match furnace.....	✓	✓	—
• <b>10-year registered limited warranty on coil, &amp; all other functional parts (Residential Use)**</b> .....	✓	✓	✓

\*Start kit may be required on outdoor unit.

\*\*Registered Limited Warranty terms are available when you register within 60 days of installation. You can register online at [americanstandardair.com](http://americanstandardair.com) or by phone at 800-554-8005; otherwise American Standard Heating & Air Conditioning's Base Limited Warranty terms will apply. Base Limited Warranty information on specific products can be found on ASDealerNet.com.

# 4GCX – Cased Heat Pump and Cooling Coils

Coils

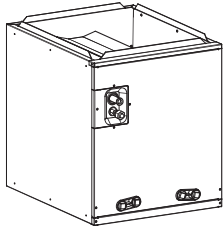

**4GCX**

**Table COIL-8-A — Aluminum High Efficiency Staged System Cased Coil (Upflow/Downflow) R-410A Refrigerant**

Model Number	Nom. Cooling Capacity Range (Btuh)	Coil Type	Refrigerant Control	Outlet Dim. (in.) W/H x D	Overall Dim. (in.) H x W x D	Shipping Weight (lbs.)	Line Size OD Gas	Line Size OD Liq.
4GXCA001AC6HUA	18,000-30,000	A	FCCV <sup>①</sup>	13 x 19	20 x 14.5 x 21	47	3/4	3/8
4GXCB002AC6HUA	18,000-30,000	A	FCCV <sup>①</sup>	16 x 19	20 x 17.5 x 21	50	3/4	3/8
4GXCA003AC6HUA	24,000-36,000	A	FCCV <sup>①</sup>	13 x 19	20 x 14.5 x 21	47	3/4	3/8
4GXCB004AC6HUA	24,000-36,000	A	FCCV <sup>①</sup>	16 x 19	20 x 17.5 x 21	50	3/4	3/8
4GXCC005AC6HUA	30,000-36,000	A	FCCV <sup>①</sup>	19 1/2 x 19	20 x 21 x 21	55	3/4	3/8
4GXCB006AC6HUA	36,000-42,000	A	FCCV <sup>①</sup>	16 x 19	26 x 17.5 x 21	61	7/8	3/8
4GXCC007AC6HUA	36,000-42,000	A	FCCV <sup>①</sup>	19 1/2 x 19	26 x 21 x 21	65	7/8	3/8
4GXCD008AC6HUA	42,000	A	FCCV <sup>①</sup>	23 x 19	26 x 24.5 x 21	68	7/8	3/8
4GXCC009AC6HUA	42,000-60,000	A	FCCV <sup>①</sup>	19 1/2 x 19	30 x 21 x 21	92	7/8	3/8
4GXCD010AC6HUA	48,000-60,000	A	FCCV <sup>①</sup>	23 x 19	30 x 24.5 x 21	96	7/8	3/8

<sup>①</sup> All coils shipped with a Fixed Metering Device (Flow Control Check Valve - FCCV). Some rated combinations require a TXV kit, ordered separately.

### Orifice Sizing Chart

(Check AHRI for ratings requiring a TXV)

		Tons						
		1.5	2	2.5	3	3.5	4	5
OD SEER <sup>③</sup>	13	0.052	0.056	0.065	0.070	0.075	0.083	0.090
	14							TXV <sup>②</sup>
	15							TXV <sup>②</sup>
	16							TXV <sup>②</sup>

<sup>②</sup> Start Kit may be required on outdoor unit.  
<sup>③</sup> The SEER is indicated in the 5th digit of the model number.

Tons	R-410A TXV Kit (If required)	R-22 TXV Kit (If required)
	1.5-3.0	4AYTXVH3G2436A
3.5-4.0	4AYTXVH3G4248A	2AYTXVH3G4248A
5	4AYTXVH3G6000A	2AYTXVH3G6000A

**Table COIL-8-B — Features**

	4GCX
• All aluminum coil .....	✓
• 100% foil lined insulation.....	✓
• Shipped with fixed factory installed orifice. Additional orifices supplied.....	✓
• Optional accessory TXV Kit with mechanical fittings available for higher performance ratings <sup>①</sup> .....	✓
• Easy case attachment to furnace.....	✓
• Upflow/Downflow application .....	✓
• Sloped non-corrosive drain pan - UL rated 275°F max .....	✓
• Dual side condensate drain options.....	✓
• Coils achieve 13-16 SEER with single stage outdoor units.....	✓
• Painted galvanized steel cabinet to match furnace.....	✓
• <b>10-year registered limited warranty on coil, &amp; all other functional parts (Residential Use)**</b> .....	✓

\*Start kit may be required on outdoor unit.

\*\*Registered Limited Warranty terms are available when you register within 60 days of installation. You can register online at americanstandardair.com or by phone at 800-554-8005; otherwise American Standard Heating & Air Conditioning's Base Limited Warranty terms will apply. Base Limited Warranty information on specific products can be found on ASDealerNet.com.

<sup>①</sup> Reference AHRI ratings to find correct TXV kit or reference Product Data for additional information.

# 4FX Cased & Uncased Cooling Only Coils

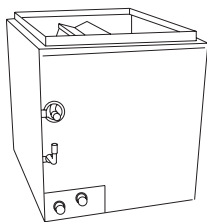

4FXC

**Table COIL-9-A — 4FXC Cooling Only Cased Coils - Upflow/Downflow R-410A Refrigerant**

Model Number	Nom. Cap. Cooling (Btuh)	Coil Type	Refrigerant Control	Outlet Dim. (in.) W/H x D	Overall Dim. (in.) H x W x D	Shipping Weight (lbs.)	Line Size OD Gas	Line Size OD Liq.
4FXCA024AC3CAB	24,000	A	TXVNB①	12 <sup>3</sup> / <sub>4</sub> x 19 <sup>3</sup> / <sub>4</sub>	19 x 14.5 x 21.5	37	3/4	3/8
4FXCB024AC3CAB	24,000	A	TXVNB①	15 <sup>3</sup> / <sub>4</sub> x 19 <sup>3</sup> / <sub>4</sub>	19 x 17.5 x 21.5	39	3/4	3/8
4FXCC024AC3CAB	24,000	A	TXVNB①	19 <sup>1</sup> / <sub>4</sub> x 19 <sup>3</sup> / <sub>4</sub>	19 x 21 x 21.5	41	3/4	3/8
4FXCB036AC3CAB	36,000	A	TXVNB①	15 <sup>3</sup> / <sub>4</sub> x 19 <sup>3</sup> / <sub>4</sub>	22.63 x 17.5 x 21.5	47	3/4	3/8
4FXCC036AC3CAB	36,000	A	TXVNB①	19 <sup>1</sup> / <sub>4</sub> x 19 <sup>3</sup> / <sub>4</sub>	22.63 x 21 x 21.5	50	3/4	3/8
4FXCD036AC3CAB	36,000	A	TXVNB①	22 <sup>3</sup> / <sub>4</sub> x 19 <sup>3</sup> / <sub>4</sub>	22.63 x 24.5 x 21.5	52	3/4	3/8
4FXCB042AC3CAB	42,000	A	TXVNB①	15 <sup>3</sup> / <sub>4</sub> x 19 <sup>3</sup> / <sub>4</sub>	22.63 x 17.5 x 21.5	47	7/8	3/8
4FXCC042AC3CAB	42,000	A	TXVNB①	19 <sup>1</sup> / <sub>4</sub> x 19 <sup>3</sup> / <sub>4</sub>	22.63 x 21 x 21.5	50	7/8	3/8
4FXCD042AC3CAB	42,000	A	TXVNB①	22 <sup>3</sup> / <sub>4</sub> x 19 <sup>3</sup> / <sub>4</sub>	22.63 x 24.5 x 21.5	52	7/8	3/8
4FXCB048AC3CAB	48,000	M	TXVNB①	15 <sup>3</sup> / <sub>4</sub> x 19 <sup>3</sup> / <sub>4</sub>	22.63 x 17.5 x 21.5	48	7/8	3/8
4FXCC048AC3CAB	48,000	M	TXVNB①	19 <sup>1</sup> / <sub>4</sub> x 19 <sup>3</sup> / <sub>4</sub>	22.63 x 21 x 21.5	50	7/8	3/8
4FXCD048AC3CAB	48,000	M	TXVNB①	22 <sup>3</sup> / <sub>4</sub> x 19 <sup>3</sup> / <sub>4</sub>	22.63 x 24.5 x 21.5	52	7/8	3/8
4FXCB060AC3CAB	60,000	M	TXVNB①	15 <sup>3</sup> / <sub>4</sub> x 19 <sup>3</sup> / <sub>4</sub>	28.75 x 17.5 x 21.5	58	7/8	3/8
4FXCC060AC3CAB	60,000	M	TXVNB①	19 <sup>1</sup> / <sub>4</sub> x 19 <sup>3</sup> / <sub>4</sub>	28.75 x 21 x 21.5	58	7/8	3/8
4FXCD060AC3CAB	60,000	M	TXVNB①	22 <sup>3</sup> / <sub>4</sub> x 19 <sup>3</sup> / <sub>4</sub>	28.75 x 24.5 x 21.5	62	7/8	3/8
4FXCB061AC3CAB	60,000	M	TXVNB①	15 <sup>3</sup> / <sub>4</sub> x 19 <sup>3</sup> / <sub>4</sub>	25 x 17.5 x 21.5	51	7/8	3/8
4FXCC061AC3CAB	60,000	M	TXVNB①	19 <sup>1</sup> / <sub>4</sub> x 19 <sup>3</sup> / <sub>4</sub>	25 x 21 x 21.5	51	7/8	3/8
4FXCD061AC3CAB	60,000	M	TXVNB①	22 <sup>3</sup> / <sub>4</sub> x 19 <sup>3</sup> / <sub>4</sub>	25 x 24.5 x 21.5	55	7/8	3/8

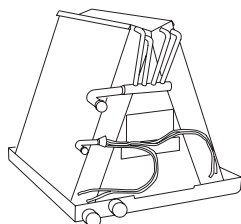

4FXA

**Table COIL-9-B — 4FXA Cooling Only Uncased Coils - Upflow/Downflow R-410A Refrigerant**

Model Number	Nom. Cap. Cooling (Btuh)	Coil Type	Refrigerant Control	Overall Dim. (in.) H x W x D	Shipping Weight (lbs.)	Line Size OD Gas	Line Size OD Liq.
4FXAA024AC3CAB	24,000	A	TXVNB①	17.5 x 13 x 19.5	17	3/4	3/8
4FXAB024AC3CAB	24,000	A	TXVNB①	17.5 x 17 x 19.5	19	3/4	3/8
4FXAC024AC3CAB	24,000	A	TXVNB①	17.5 x 20 x 19.5	21	3/4	3/8
4FXAN036AC3CAB	36,000	A	TXVNB①	21.5 x 15 x 19.5	28	3/4	3/8
4FXAB036AC3CAB	36,000	A	TXVNB①	21.5 x 17 x 19.5	28	3/4	3/8
4FXAC036AC3CAB	36,000	A	TXVNB①	21.5 x 20 x 19.5	30	3/4	3/8
4FXAD036AC3CAB	36,000	A	TXVNB①	21.5 x 24 x 19.5	32	3/4	3/8
4FXAN042AC3CAB	42,000	A	TXVNB①	21.5 x 15 x 19.5	28	3/4	3/8
4FXAB042AC3CAB	42,000	A	TXVNB①	21.5 x 17 x 19.5	28	7/8	3/8
4FXAC042AC3CAB	42,000	A	TXVNB①	21.5 x 20 x 19.5	30	7/8	3/8
4FXAD042AC3CAB	42,000	A	TXVNB①	21.5 x 24 x 19.5	32	7/8	3/8
4FXAB048AC3CAB	48,000	M	TXVNB①	19.5 x 17 x 19.5	28	7/8	3/8
4FXAC048AC3CAB	48,000	M	TXVNB①	19.5 x 20 x 19.5	30	7/8	3/8
4FXAD048AC3CAB	48,000	M	TXVNB①	19.5 x 24 x 19.5	32	7/8	3/8
4FXAB060AC3CAB	60,000	M	TXVNB①	25.5 x 17 x 19.5	38	7/8	3/8
4FXAC060AC3CAB	60,000	M	TXVNB①	25.5 x 20 x 19.5	40	7/8	3/8
4FXAD060AC3CAB	60,000	M	TXVNB①	25.5 x 24 x 19.5	42	7/8	3/8
4FXAB061AC3CAB	60,000	M	TXVNB①	21.5 x 17 x 19.5	31	7/8	3/8
4FXAC061AC3CAB	60,000	M	TXVNB①	21.5 x 20 x 19.5	33	7/8	3/8
4FXAD061AC3CAB	60,000	M	TXVNB①	21.5 x 24 x 19.5	35	7/8	3/8

① Start Kit may be required on outdoor unit.



# 4FX Flat & Horizontal Cooling Only Coils

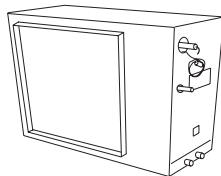

**4FXFH**

**Table COIL-10-A — 4FXFH Cooling Only Flat Coils R-410A Refrigerant**

Model Number	Nom. Cap. Cooling (Btuh)	Coil Type	Refrigerant Control	Outlet Dim. (in.) W/H x D	Overall Dim. (in.) H x W x D	Shipping Weight (lbs.)	Line Size OD Gas	Line Size OD Liq.
4FXFH024AC3CHB	30,000	Flat	TXVNB <sup>①</sup>	16 x 21	24.5 x 24.5 x 10	27	3/4	3/8
4FXFH036AC3CHB	36,000	Flat	TXVNB <sup>①</sup>	30 x 21	24.5 x 36 x 10	33	3/4	3/8
4FXFH060AC3CHB	60,000	Flat	TXVNB <sup>①</sup>	30 x 21	24.5 x 36 x 10	40	7/8	3/8
4FXFH063AC3CHB	63,000	Flat	TXVNB <sup>①</sup>	34 x 21	24.5 x 37 x 10	45	7/8	3/8

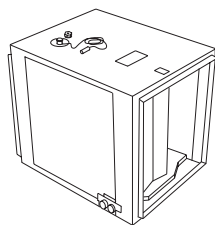

**4FXCH**

**Table COIL-10-B — 4FXCH Cooling Only Horizontal Coils R-410A Refrigerant**

Model Number	Nom. Cap. Cooling (Btuh)	Coil Type	Refrigerant Control	Outlet Dim. (in.) W/H x D	Overall Dim. (in.) H x W x D	Shipping Weight (lbs.)	Line Size OD Gas	Line Size OD Liq.
4FXCH024AC3CHB	30,000	A	TXVNB <sup>①</sup>	16.5 x 18.5	18.25 x 25 x 20.25	42	3/4	3/8
4FXCH036AC3CHB	36,000	A	TXVNB <sup>①</sup>	16.5 x 18.5	18.25 x 34.75 x 20.25	49	3/4	3/8
4FXCH048AC3CHB	48,000	A	TXVNB <sup>①</sup>	20.5 x 18.5	20.25 x 34.75 x 20.25	52	7/8	3/8
4FXCH060AC3CHB	60,000	A	TXVNB <sup>①</sup>	20.5 x 18.5	20.25 x 34.75 x 20.25	55	7/8	3/8

<sup>①</sup> Start Kit may be required on outdoor unit.

# S9V2 – Two Stage ECM Variable Speed

**Table FUR-1-A — Variable Speed, 2 Stage, Direct Vent, Upflow/Horizontal Left/Horizontal Right Condensing Gas Furnace (120/1/60) ③**

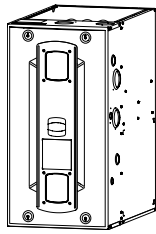

**S9V2  
Direct Vent**

Unit Model No.	Airflow In Tons	Output (Btuh)		ICS ① AFUE	Flue Size (in)	Ignition Device	Uncrated Dimensions (in.) H x W x D	Shipping Weight (lbs.)	Max Fuse*	Filter Sizes**
		Stage 2	Stage 1							
S9V2B040U3PSAA	3	38,800	25,220	96.0②	2, 3, 4	④	34 x 17 <sup>1</sup> / <sub>2</sub> x 28 <sup>3</sup> / <sub>4</sub>	122	15	17 x 25 x 1
S9V2B060U3PSAA	3	58,200	37,830	96.0②	2, 3, 4	④	34 x 17 <sup>1</sup> / <sub>2</sub> x 28 <sup>3</sup> / <sub>4</sub>	127	15	17 x 25 x 1
S9V2B060U4PSAA	4	58,200	37,830	96.0②	2, 3, 4	④	34 x 17 <sup>1</sup> / <sub>2</sub> x 28 <sup>3</sup> / <sub>4</sub>	130	15	17 x 25 x 1
S9V2B080U3PSAA	3	77,600	50,440	96.0②	2, 3, 4	④	34 x 17 <sup>1</sup> / <sub>2</sub> x 28 <sup>3</sup> / <sub>4</sub>	132	15	17 x 25 x 1
S9V2B080U4PSAA	4	77,600	50,440	96.0②	2, 3, 4	④	34 x 17 <sup>1</sup> / <sub>2</sub> x 28 <sup>3</sup> / <sub>4</sub>	135	15	17 x 25 x 1
S9V2C080U5PSAA	5	77,600	50,440	96.0②	2, 3, 4	④	34 x 21 x 28 <sup>3</sup> / <sub>4</sub>	149	15	20 x 25 x 1
S9V2C100U4PSAA	4	97,000	63,050	96.0②	2, 3, 4	④	34 x 21 x 28 <sup>3</sup> / <sub>4</sub>	154	15	20 x 25 x 1
S9V2C100U5PSAA	5	97,000	63,050	96.0②	2, 3, 4	④	34 x 21 x 28 <sup>3</sup> / <sub>4</sub>	155	15	20 x 25 x 1
S9V2D120U5PSAA	5	116,400	75,660	96.0②	3, 4	④	34 x 24 <sup>1</sup> / <sub>2</sub> x 28 <sup>3</sup> / <sub>4</sub>	167	15	24 x 25 x 1

Note: Variable speed furnaces should not be twinned and are not approved for twinning applications.

**Table FUR-1-B — Variable Speed, 2 Stage, Direct Vent, Downflow Condensing Gas Furnace (120/1/60) ③**

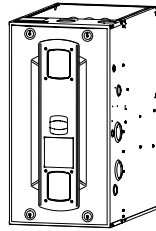

**S9V2  
Direct Vent**

Unit Model No.	Airflow In Tons	Output (Btuh)		ICS ① AFUE	Flue Size (in)	Ignition Device	Uncrated Dimensions (in.) H x W x D	Shipping Weight (lbs.)	Max Fuse*	Filter Sizes**
		Stage 2	Stage 1							
S9V2B040D3PSAA	3	38,800	25,220	96.0②	2, 3, 4	④	34 x 17 <sup>1</sup> / <sub>2</sub> x 28 <sup>3</sup> / <sub>4</sub>	122	15	(2)14 x 20 x 1
S9V2B060D3PSAA	3	58,200	37,830	96.0②	2, 3, 4	④	34 x 17 <sup>1</sup> / <sub>2</sub> x 28 <sup>3</sup> / <sub>4</sub>	127	15	(2)14 x 20 x 1
S9V2B080D3PSAA	3	77,600	50,440	96.0②	2, 3, 4	④	34 x 17 <sup>1</sup> / <sub>2</sub> x 28 <sup>3</sup> / <sub>4</sub>	132	15	(2)14 x 20 x 1
S9V2B080D4PSAA	4	77,600	50,440	96.0②	2, 3, 4	④	34 x 17 <sup>1</sup> / <sub>2</sub> x 28 <sup>3</sup> / <sub>4</sub>	135	15	(2)14 x 20 x 1
S9V2C100D4PSAA	4	97,000	63,050	96.0②	2, 3, 4	④	34 x 21 x 28 <sup>3</sup> / <sub>4</sub>	154	15	(2)16 x 20 x 1
S9V2C100D5PSAA	5	97,000	63,050	96.0②	2, 3, 4	④	34 x 21 x 28 <sup>3</sup> / <sub>4</sub>	155	15	(2)16 x 20 x 1
S9V2D120D5PSAA	5	116,400	75,660	96.0②	3, 4	④	34 x 24 <sup>1</sup> / <sub>2</sub> x 28 <sup>3</sup> / <sub>4</sub>	167	15	(2)16 x 20 x 1

Note: Variable speed furnaces should not be twinned and are not approved for twinning applications.

① Isolated Combustion System.

② Energy Star.

③ Direct drive variable speed motor is an ECM constant airflow blower motor.

④ Silicon Nitride Igniter.

\* Information subject to change. Please confirm with current Product Data/Service Facts for current factory production.

\*\* Filters are not shipped with furnace.

# S9V2 Convertible Gas Furnaces

Furnaces

**Table FUR-2-A — Features**

	S9V2 Variable Speed
• <b>Comfort-R™</b> enhanced mode (cooling).....	✓
• Standard 34" height .....	✓
• 3 Way poise Upflow furnace model (Upflow, Horizontal Left, Horizontal Right) .....	✓
• Dedicated Downflow furnace model .....	✓
• Front service access with easily accessible burners, sensors orifices, switches, and other components .....	✓
• Cabinet has no knockouts - Rubber and plastic plugs come installed from factory .....	✓
• Gas can enter either side of cabinet .....	✓
• Condensate can exit either side of cabinet in Upflow orientation .....	✓
• Multiple venting options - Every model, every size will offer two venting options.....	✓
• New IntegratedFurnace Control board with digital configuration, status, and fault codes.....	✓
• Improved alpha-numeric diagnostic codes .....	✓
• Dry contact Humidifier/EAC hook-up capability.....	✓
• Adjustable blower off delay for heating and cooling.....	✓
• Last six fault codes are stored (even with power loss) .....	✓
• Stainless steel primary and secondary heat exchanger tubes.....	✓
• Longer IFC wire harnesses allow door to be removed without disconnecting the harness .....	✓
• Alternate bottom/left/right return air (upflow models only) .....	✓
• Bottom panel (upflow models only) .....	✓
• Direct drive, variable speed ECM blower motor - Constant airflow ECM (electronically commutated motor) .....	✓
• Dual PVC pipe venting (1 or 2 pipe option) .....	✓
• Two stage combination gas valve and regulator.....	✓
• Gasketed inner and outer door .....	✓
• Heavy gauge reinforced wrap-around steel cabinet .....	✓
• Insulated blower compartment.....	✓
• Left/right condensate drain capability in vertical application .....	✓
• Service diagnostics with faults reported on IFC board .....	✓
• Manual reset flame roll out switches.....	✓
• Mobile home approved with mobile home kit.....	✓
• Multi-port in shot burners .....	✓
• Painted cabinet two tone color.....	✓
• Service diagnostic capabilities.....	✓
• Vortica® II blower housing .....	✓
• Slide out blower assembly on full-length rails .....	✓
• Side return duct starter tabs (upflow models only) .....	✓
• Silicon Nitride 120V hot surface igniter .....	✓
• Multiple heating blower speeds.....	✓
• Meets requirements for 2% or less air leakage .....	✓
• <b>Registered limited lifetime heat exchanger warranty &amp; 10-year on all other functional parts (Residential Use)①</b> .....	✓
• <b>Optional extended warranties available</b> .....	✓

① Registered Limited Warranty terms are available when you register within 60 days of installation. You can register online at [americanstandardair.com](http://americanstandardair.com) or by phone at 800-554-8005; otherwise American Standard Heating & Air Conditioning's Base Limited Warranty terms will apply. Base Limited Warranty information on specific products can be found on [ASDealerNet.com](http://ASDealerNet.com).

Note: Variable speed furnaces should not be twinned and are not approved for twinning applications.

**Table FUR-2-B — Optional Accessories**

Model Number	Description	Shipping Weight	S9V2 - 2 Stage 1 or 2 Pipe
BAYLPSS400A	LP Kit with Stainless Steel Burners .....	2	✓
BAYHANG	Horizontal hanging kit .....	2	✓
BAYVENT200B	Sidewall vent Termination Kit fo Direct vent furnaces .....	2	✓
BAYVENTCN200B	Sidewall vent Termination Kit fo Direct vent furnaces for Canadian applications .....	2	✓
BAYAIR30AVENTA	Concentric vent kit for 2, 2½ and 3" vent system .....	11	✓
BAYAIR30CNVENT	Concentric vent kit for 2, 2½ and 3" vent system for Canadian applications .....	11	✓
BAYREDUCE	Reducer Coupling for Canadian applications (CPVC).....	1	✓
BAYLIFTB	Dual return kit. B size extension.....	8	✓
BAYLIFTC	Dual return kit. C size extension .....	9	✓
BAYLIFTD	Dual return kit. D size extension .....	9	✓
BAYMFGH200A	Manufactured/mobil home kit .....	2	✓
BAYBASE205	Downflow subbase .....	8	✓
BAYFLTR206	Filter Access Door Kit .....	2	✓

For complete equipment / combination selections, installation instructions and warranty information, please refer to Product Data/Ratings and/or Installers Guides and Limited Warranty Handbooks.

# Platinum 95, Gold 95v, Gold 95, Silver 95, Silver 95h, and American Standard 92 Convertible Gas Furnaces Airflow Directions

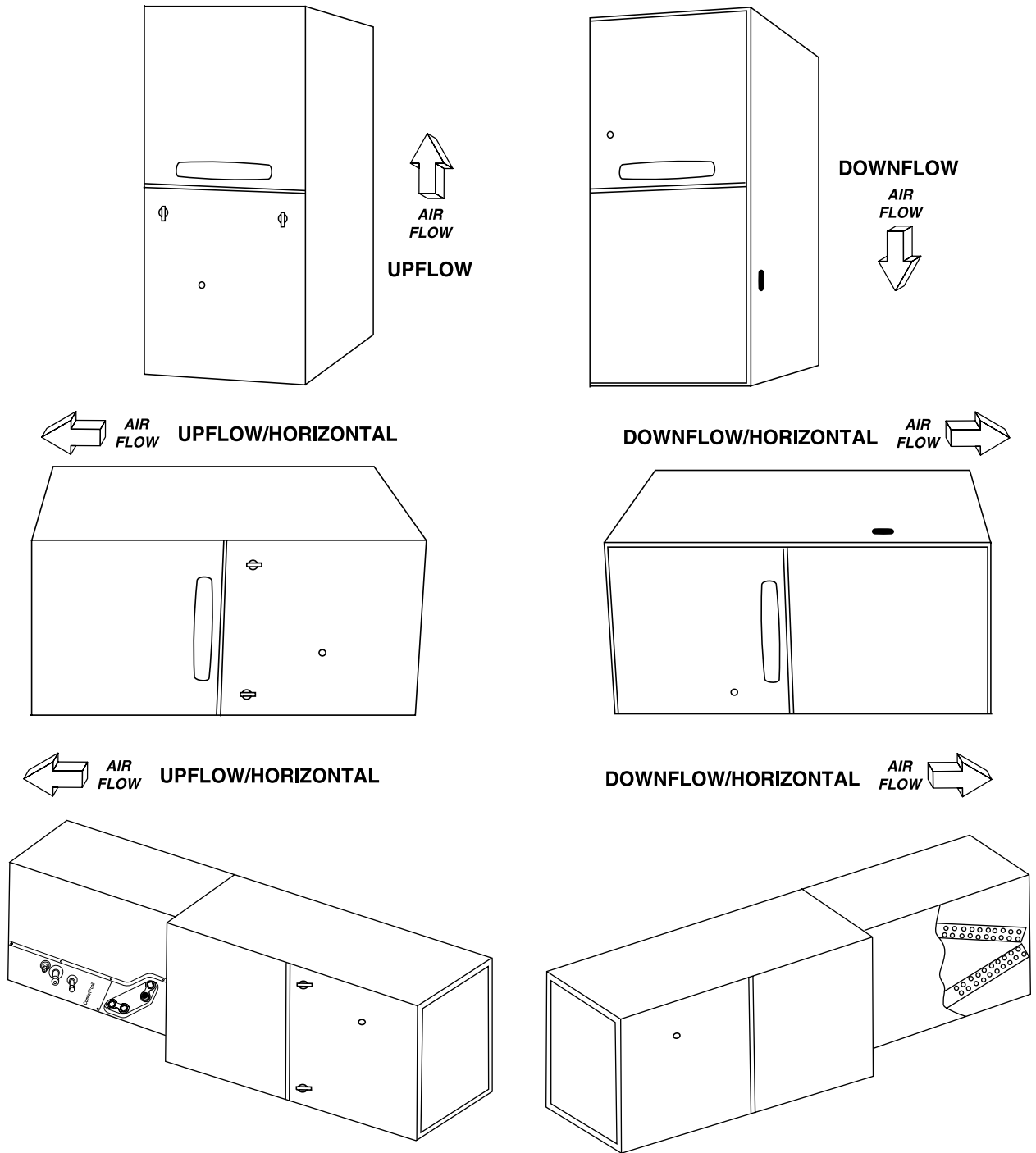

Furnaces

**Note:** The forty inch (40") height condensing downflow/horizontal and upflow/horizontal furnaces may only be rotated onto their left side. Connection brackets for coil/furnace alignment are included with the furnaces. The apex of the coil may point into or away from the airflow.

# Platinum 95 – Modulating, Communicating ECM Variable Speed

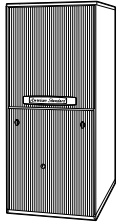

**Platinum 95  
Direct/Non-Direct  
Vent**

**Table FUR-4-A — Variable Speed, Communicating, Modulating Direct/Non-Direct Vent, Upflow/Horizontal Left  
Condensing Gas Furnace (115/1/60)<sup>④⑤⑦</sup>**

Unit Model No.	Airflow In Tons	Output (Btuh)		ICS <sup>①</sup> AFUE	Flue Size (in)	Ignition Device	Uncrated Dimensions (in.) H x W x D	Shipping Weight (lbs.)	Max Fuse*	Filter Sizes
		Stage 3 High Stage/100%	Stage 1 Low Stage/40% <sup>③</sup>							
AUHMB060ACV3VB	3	58,380	23,352	97.3 <sup>②</sup>	2, 2 1/2, 3	⑥	40 x 17 1/2 x 28	158	15	17 x 25 x 1
AUHMB080ACV3VB	3	77,360	30,944	96.7 <sup>②</sup>	2, 2 1/2, 3	⑥	40 x 17 1/2 x 28	168	15	17 x 25 x 1
AUHMC100ACV4VB	4	96,000	38,400	96.0	2 1/2, 3	⑥	40 x 21 x 28	197	15	20 x 25 x 1
AUHMD120ACV5VB	5	116,400	52,380	97.0 <sup>②</sup>	3	⑥	40 x 24 1/2 x 28	206	15	24 x 25 x 1

Note: Variable speed furnaces should not be twinned and are not approved for twinning applications.

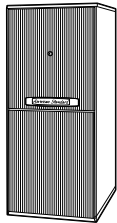

**Platinum 95  
Direct/Non-Direct  
Vent**

**Table FUR-4-B — Variable Speed, Communicating, Modulating Direct/Non-Direct Vent, Downflow/Horizontal  
Right Condensing Gas Furnace (115/1/60)<sup>④⑤⑦</sup>**

Unit Model No.	Airflow In Tons	Output (Btuh)		ICS <sup>①</sup> AFUE	Flue Size (in)	Ignition Device	Uncrated Dimensions (in.) H x W x D	Shipping Weight (lbs.)	Max Fuse*	Filter Sizes
		Stage 3 High Stage/100%	Stage 1 Low Stage/40%							
ADHMB060BCV3VB	3	57,000	22,800	95.0 <sup>②</sup>	2, 2 1/2, 3	⑥	40 x 17 1/2 x 28	160	15	(2)14 x 20 x 1
ADHMB080ACV3VB	3	76,000	30,400	96.0 <sup>②</sup>	2, 2 1/2, 3	⑥	40 x 17 1/2 x 28	168	15	(2)14 x 20 x 1
ADHMC100ACV4VB	4	96,000	38,400	96.0	2 1/2, 3	⑥	40 x 21 x 28	185	15	(2)16 x 20 x 1
ADHMD120BCV5VB	5	114,000	51,300	95.0 <sup>②</sup>	3	⑥	40 x 24 1/2 x 28	206	15	(2)16 x 20 x 1

Note: Variable speed furnaces should not be twinned and are not approved for twinning applications.

## Gold 95v – Two Stage ECM Variable Speed

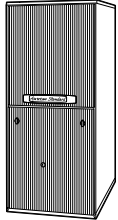

**Gold 95v  
Direct/Non-Direct  
Vent**

**Table FUR-4-C — Variable Speed, Direct/Non-Direct Vent, Upflow/Horizontal Left Condensing Gas Furnace  
(115/1/60)**

Unit Model No.	Airflow In Tons	Output (Btuh)		ICS <sup>①</sup> AFUE	Flue Size (in)	Ignition Device	Uncrated Dimensions (in.) H x W x D	Shipping Weight (lbs.)	Max Fuse*	Filter Sizes
		Stage 2	Stage 1							
AUH2B060A9V3VB	3	58,200	37,830	97.0 <sup>②</sup>	2, 2 1/2, 3	⑥	40 x 17 1/2 x 28	158	15	17 x 25 x 1
AUH2B080A9V3VB	3	77,600	50,440	97.0 <sup>②</sup>	2, 2 1/2, 3	⑥	40 x 17 1/2 x 28	168	15	17 x 25 x 1
AUH2B080A9V4VB	4	77,600	50,440	97.0 <sup>②</sup>	2, 2 1/2, 3	⑥	40 x 17 1/2 x 28	170	15	17 x 25 x 1
AUH2C100A9V4VB	4	96,700	62,855	96.7 <sup>②</sup>	2 1/2, 3	⑥	40 x 21 x 28	197	15	20 x 25 x 1
AUH2C100A9V5VB	5	96,700	62,855	96.7 <sup>②</sup>	2 1/2, 3	⑥	40 x 21 x 28	199	20	20 x 25 x 1
AUH2D120A9V5VB	5	116,040	75,426	96.7 <sup>②</sup>	3	⑥	40 x 24 1/2 x 28	206	20	24 x 25 x 1

Note: Variable speed furnaces should not be twinned and are not approved for twinning applications.



**Gold 95v  
Direct/Non-Direct  
Vent**

**Table FUR-4-D — Variable Speed, Direct/Non-Direct Vent, Downflow/Horizontal Right Condensing Gas Furnace  
(115/1/60)**

Unit Model No.	Airflow In Tons	Output (Btuh)		ICS <sup>①</sup> AFUE	Flue Size (in)	Ignition Device	Uncrated Dimensions (in.) H x W x D	Shipping Weight (lbs.)	Max Fuse*	Filter Sizes
		Stage 2	Stage 1							
ADH2B060A9V3VB	3	57,600	37,440	96.0 <sup>②</sup>	2, 2 1/2, 3	⑥	40 x 17 1/2 x 28	160	15	(2)14 x 20 x 1
ADH2B080A9V3VB	3	76,800	49,920	96.0 <sup>②</sup>	2, 2 1/2, 3	⑥	40 x 17 1/2 x 28	168	15	(2)14 x 20 x 1
ADH2B080A9V4VB	4	76,000	49,400	95.0 <sup>②</sup>	2, 2 1/2, 3	⑥	40 x 17 1/2 x 28	172	15	(2)14 x 20 x 1
ADH2C100A9V4VB	4	96,000	62,400	96.0 <sup>②</sup>	2 1/2, 3	⑥	40 x 21 x 28	185	15	(2)16 x 20 x 1
ADH2D120A9V5VB	5	115,200	74,880	96.0 <sup>②</sup>	3	⑥	40 x 24 1/2 x 28	206	20	(2)16 x 20 x 1

① Isolated Combustion System.

② Energy Star.

③ Low stage is equal to 45% for AUHMD120 model.

④ Furnace use in 24, non-communicating mode.

⑤ Direct drive variable speed motor is an ECM constant airflow blower motor.

⑥ Silicon Nitride

⑦ Must use ACONT900 or AZONE950 control in communicating mode.

\* Information subject to change. Please confirm with current Product Data/Service Facts for current factory production.

\*\* Filters are not shipped with furnace.

Note: Variable speed furnaces should not be twinned and are not approved for twinning applications

# Gold 95 – Two Stage

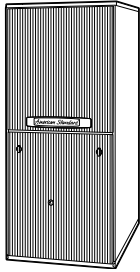

Gold 95 Direct/  
Non-Direct Vent

**Table FUR-5-A — Direct/Non-Direct Vent, Upflow/Horizontal Left Condensing Gas Furnace (115/1/60)**

Unit Model No.	Airflow In	Output (Btuh)		ICS <sup>①</sup> AFUE	Flue Size (in)	Ignition Device	Uncrated Dimensions (in.) H x W x D	Shipping Weight (lbs.)	Max Fuse*	Filter** Sizes
	Tons	Stage 2	Stage 1							
AUH2B060A936VA	3	57,600	37,440	96.0	2, 2 <sup>1</sup> / <sub>2</sub> , 3	②	40 x 17 <sup>1</sup> / <sub>2</sub> x 28	150	15	17 x 25 x 1
AUH2B080A942VA	3 <sup>1</sup> / <sub>2</sub>	76,800	49,920	96.0	2, 2 <sup>1</sup> / <sub>2</sub> , 3	②	40 x 17 <sup>1</sup> / <sub>2</sub> x 28	158	15	17 x 25 x 1
AUH2C100A948VA	4	96,000	62,400	96.0	2 <sup>1</sup> / <sub>2</sub> , 3	②	40 x 21 x 28	171	20	20 x 25 x 1
AUH2D120A960VA	5	115,200	74,880	96.0	3	②	40 x 24 <sup>1</sup> / <sub>2</sub> x 28	205	20	24 x 25 x 1

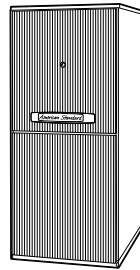

Gold 95 Direct/  
Non-Direct Vent

**Table FUR-5-B — Direct/Non-Direct Vent, Downflow/Horizontal Right Condensing Gas Furnace (115/1/60)**

Unit Model No.	Airflow In	Output (Btuh)		ICS <sup>①</sup> AFUE	Flue Size (in)	Ignition Device	Uncrated Dimensions (in.) H x W x D	Shipping Weight (lbs.)	Max Fuse*	Filter** Sizes
	Tons	Stage 2	Stage 1							
ADH2B060A936VA	2	57,000	37,000	95.0	2, 2 <sup>1</sup> / <sub>2</sub> , 3	②	40 x 17 <sup>1</sup> / <sub>2</sub> x 28	155	15	(2)14 x 20 x 1
ADH2B080A942VA	3 <sup>1</sup> / <sub>2</sub>	76,000	49,400	95.0	2, 2 <sup>1</sup> / <sub>2</sub> , 3	②	40 x 17 <sup>1</sup> / <sub>2</sub> x 28	168	15	(2)14 x 20 x 1
ADH2C100A948VA	4	95,000	61,800	95.0	2 <sup>1</sup> / <sub>2</sub> , 3	②	40 x 21 x 28	185	20	(2)16 x 20 x 1
ADH2D120A960VA	5	115,200	74,880	96.0	3	②	40 x 24 <sup>1</sup> / <sub>2</sub> x 28	206	20	(2)16 x 20 x 1

① Isolated Combustion System.

② Silicon Nitride.

\* Information subject to change. Please confirm with current Product Data/Service Facts for current factory production.

\*\* Filters are not shipped with furnace.

# Silver 95 – Single Stage

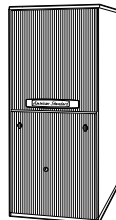

Silver 95  
Direct/Non-Direct  
Vent

**Table FUR-5-C — Direct/Non-Direct Vent, Upflow/Horizontal Left Condensing Gas Furnace (115/1/60)**

Unit Model No.	Airflow In	Nominal Output (Btuh)	ICS <sup>①</sup> AFUE	Flue Size (in)	Ignition Device	Uncrated Dimensions (in.) H x W x D	Shipping Weight (lbs.)	Max Fuse*	Filter** Sizes
	Tons	(Btuh)							
AUH1B040A9241A	2	38,000	95.0	2, 2 <sup>1</sup> / <sub>2</sub> , 3	②	40 x 17 <sup>1</sup> / <sub>2</sub> x 28	139	15	17 x 25 x 1
AUH1B060A9361A	3	57,000	95.0	2, 2 <sup>1</sup> / <sub>2</sub> , 3	②	40 x 17 <sup>1</sup> / <sub>2</sub> x 28	150	15	17 x 25 x 1
AUH1B080A9421B	3 <sup>1</sup> / <sub>2</sub>	73,150	95.0	2, 2 <sup>1</sup> / <sub>2</sub> , 3	②	40 x 17 <sup>1</sup> / <sub>2</sub> x 28	158	15	17 x 25 x 1
AUH1C080A9601A	5	76,000	95.0	3	②	40 x 21 x 28	171	20	20 x 25 x 1
AUH1C100A9481A	4	92,150	95.0	3	②	40 x 21 x 28	171	20	20 x 25 x 1
AUH1D100A9601A	5	92,150	95.0	3	②	40 x 24 <sup>1</sup> / <sub>2</sub> x 28	197	20	24 x 25 x 1
AUH1D120A9601A	5	104,500	95.0	3	②	40 x 24 <sup>1</sup> / <sub>2</sub> x 28	205	20	24 x 25 x 1

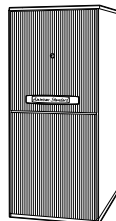

Silver 95  
Direct/Non-Direct  
Vent

**Table FUR-5-D — Direct/Non-Direct Vent, Downflow/Horizontal Right Condensing Gas Furnace (115/1/60)**

Unit Model No.	Airflow In	Nominal Output (Btuh)	ICS <sup>①</sup> AFUE	Flue Size (in)	Ignition Device	Uncrated Dimensions (in.) H x W x D	Shipping Weight (lbs.)	Max <sup>②</sup> Fuse*	Filter** Sizes
	Tons	(Btuh)							
ADH1B040A9241A	2	38,000	95.0	2, 2 <sup>1</sup> / <sub>2</sub> , 3	②	40 x 17 <sup>1</sup> / <sub>2</sub> x 28	155	15	(2)14 x 20 x 1
ADH1B065A9421A	3 <sup>1</sup> / <sub>2</sub>	57,000	95.0	2, 2 <sup>1</sup> / <sub>2</sub> , 3	②	40 x 17 <sup>1</sup> / <sub>2</sub> x 28	168	15	(2)14 x 20 x 1
ADH1C085A9481A	4	76,000	95.0	2 <sup>1</sup> / <sub>2</sub> , 3	②	40 x 21 x 28	185	20	(2)16 x 20 x 1
ADH1D110A9601A	5	104,500	95.0	2 <sup>1</sup> / <sub>2</sub> , 3	②	40 x 24 <sup>1</sup> / <sub>2</sub> x 28	206	20	(2)16 x 20 x 1

① Isolated Combustion System.

② Silicon Nitride

\* Information subject to change. Please confirm with current Product Data/Service Facts for current factory production.

\*\* Filters are not shipped with furnace.

# Silver 95h - Single Stage with ECM Multi-Speed Motor

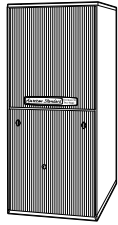

**Silver 95h  
Direct/Non-Direct  
Vent**

**Table FUR-6-A — Direct/Non-Direct Vent, Upflow/Horizontal Left Condensing Gas Furnace with Filter**

Unit Model No.	Airflow In Tons	Nominal Output (Btuh)	ICS <sup>①</sup> AFUE	Flue Size (in)	Ignition Device	Uncrated Dimensions (in.) H x W x D	Shipping Weight (lbs.)	Max Fuse*	Filter Sizes
AUH1B040A9H21B	2	38,000	95.0	2, 2 <sup>1</sup> / <sub>2</sub> , 3	②	40 x 17 <sup>1</sup> / <sub>2</sub> x 28	139	15	17 x 25 x 1
AUH1B060A9H31B	3	57,000	95.0	2, 2 <sup>1</sup> / <sub>2</sub> , 3	②	40 x 17 <sup>1</sup> / <sub>2</sub> x 28	150	15	17 x 25 x 1
AUH1B080A9H31C	3	73,150	95.0	2, 2 <sup>1</sup> / <sub>2</sub> , 3	②	40 x 17 <sup>1</sup> / <sub>2</sub> x 28	158	15	17 x 25 x 1
AUH1C100A9H41B	3 <sup>1</sup> / <sub>2</sub>	92,150	95.0	3	②	40 x 21 x 28	171	15	20 x 25 x 1
AUH1D120A9H51B	5	104,500	95.0 <sup>③</sup>	3	②	40 x 24 <sup>1</sup> / <sub>2</sub> x 28	205	15	24 x 25 x 1
ADH1B040A9H21B	2	38,000	95.0	2, 2 <sup>1</sup> / <sub>2</sub> , 3	②	40 x 17 <sup>1</sup> / <sub>2</sub> x 28	145	15	(2) 14 x 20 x 1
ADH1B065A9H31B	3	57,000	95.0	2, 2 <sup>1</sup> / <sub>2</sub> , 3	②	40 x 17 <sup>1</sup> / <sub>2</sub> x 28	158	15	(2) 14 x 20 x 1
ADH1C085A9H41B	4	76,000	95.0	2 <sup>1</sup> / <sub>2</sub> , 3	②	40 x 21 x 28	171	15	(2) 16 x 20 x 1
ADH1D110A9H51B	5	104,500	95.0	2 <sup>1</sup> / <sub>2</sub> , 3	②	40 x 24 <sup>1</sup> / <sub>2</sub> x 28	205	15	(2) 16 x 20 x 1

- ① Isolated Combustion System.
- ② Silicon Nitride.
- ③ Energy Star

# American Standard 92 – Single Stage

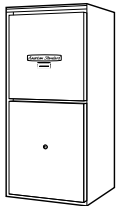

**American Standard 92**

**Table FUR-6-B — Direct/Non-Direct Vent, Upflow/Horizontal Left Condensing Gas Furnace (115/1/60)**

Unit Model No.	Airflow In Tons	Nominal Output (Btuh)	AFUE	Flue Size (in)	Ignition Device	Uncrated Dimensions (in.) H x W x D	Shipping Weight (lbs.)	Max Fuse*	Filter** Sizes
AUC1B040A9241A	2	37,000	92.1	2, 2 <sup>1</sup> / <sub>2</sub> , 3	Silicon Nitride	40 x 17 <sup>1</sup> / <sub>2</sub> x 28	139	15	17 x 25 x 1
AUC1B060A9361A	3	56,000	92.1	2, 2 <sup>1</sup> / <sub>2</sub> , 3	Silicon Nitride	40 x 17 <sup>1</sup> / <sub>2</sub> x 28	150	15	17 x 25 x 1
AUC1B080A9421A	3 <sup>1</sup> / <sub>2</sub>	74,000	92.1	2, 2 <sup>1</sup> / <sub>2</sub> , 3	Silicon Nitride	40 x 17 <sup>1</sup> / <sub>2</sub> x 28	158	15	17 x 25 x 1
AUC1C100A9481A	4	94,000	92.1	2 <sup>1</sup> / <sub>2</sub> , 3	Silicon Nitride	40 x 21 x 28	171	20	20 x 25 x 1
AUC1D100A9601A	5	93,000	92.1	2 <sup>1</sup> / <sub>2</sub> , 3	Silicon Nitride	40 x 24 <sup>1</sup> / <sub>2</sub> x 28	197	20	24 x 25 x 1
AUC1D120A9601A	5	113,000	92.1	2 <sup>1</sup> / <sub>2</sub> , 3	Silicon Nitride	40 x 24 <sup>1</sup> / <sub>2</sub> x 28	205	20	24 x 25 x 1

**Table FUR-6-C — Direct/Non-Direct Vent, Downflow/Horizontal Right Condensing Gas Furnace (115/1/60)**

Unit Model No.	Airflow In Tons	Nominal Output (Btuh)	AFUE	Flue Size (in)	Ignition Device	Uncrated Dimensions (in.) H x W x D	Shipping Weight (lbs.)	Max Fuse*	Filter** Sizes
ADC1B040A9241A	2	37,000	92.1	2, 2 <sup>1</sup> / <sub>2</sub> , 3	Silicon Nitride	40 x 17 <sup>1</sup> / <sub>2</sub> x 28	145	15	(2) 14 x 20 x 1
ADC1B060A9361A	3	56,000	92.1	2, 2 <sup>1</sup> / <sub>2</sub> , 3	Silicon Nitride	40 x 17 <sup>1</sup> / <sub>2</sub> x 28	155	15	(2) 14 x 20 x 1
ADC1B080A9421A	3 <sup>1</sup> / <sub>2</sub>	74,000	92.1	2, 2 <sup>1</sup> / <sub>2</sub> , 3	Silicon Nitride	40 x 17 <sup>1</sup> / <sub>2</sub> x 28	168	15	(2) 14 x 20 x 1
ADC1C100A9481A	4	93,000	92.1	2 <sup>1</sup> / <sub>2</sub> , 3	Silicon Nitride	40 x 21 x 28	185	20	(2) 16 x 20 x 1
ADC1D120A9601A	5	112,000	92.1	2 <sup>1</sup> / <sub>2</sub> , 3	Silicon Nitride	40 x 24 <sup>1</sup> / <sub>2</sub> x 28	206	20	(2) 16 x 20 x 1

- \* Information subject to change. Please confirm with current Product Data/Service Facts for current factory production.
- \*\* Filters are not shipped with furnace.

# Platinum 95, Gold 95v, Gold 95, Silver 95, Silver 95h, and American Standard 92 Convertible Gas Furnaces

**Airflow Directions:**

Downflow models when placed in horizontal position provide left to right airflow. Upflow models when placed in horizontal position provide right to left airflow.

**Table FUR-7-A — Features**

	AUHM/ ADHM Modulating 1 or 2 Pipe Variable Speed	AUH2/ ADH2 2 Stage 1 or 2 Pipe Variable Speed	AUH1-H/ ADH1-H 1 Stage 1 or 2 Pipe Variable Speed	AUH2/ ADH2 1 Stage 1 or 2 Pipe PSC	AUH1/ ADH1 1 Stage 1 or 2 Pipe	AUC1/ ADC1 1 Stage 1 or 2 Pipe
• <b>Comfort-R™</b> enhanced mode (cooling).....	✓	✓	—	—	—	—
• <b>AccuLink™</b> system② .....	✓	—	—	—	—	—
• Adjustable heating fan off timing.....	✓	✓	✓	✓	✓	✓
• Alternate bottom/left/right return air (upflow models only) .....	✓	✓	✓	✓	✓	✓
• Blower door safety switch .....	✓	✓	✓	✓	✓	✓
• Bottom panel (upflow models only) .....	✓	✓	✓	✓	✓	✓
• Cleanable/Reusable high velocity filters .....	✓	✓	✓	—	—	—
• Complete front service access .....	✓	✓	✓	✓	✓	✓
• Direct drive, multi-speed (PSC) blower motor.....	—	—	—	✓	✓	✓
• Direct drive, multi-speed ECM blower motor (high efficiency)* .....	—	—	✓	—	—	—
• Direct drive, variable speed ECM blower motor** .....	✓	✓	—	—	—	—
• Downflow horizontal right (downflow models only) .....	✓	✓	✓	✓	✓	✓
• Dual PVC pipe venting (1 or 2 pipe option) .....	✓	✓	✓	✓	✓	✓
• Two stage combination gas valve and regulator.....	—	✓	—	—	—	—
• One stage combination gas valve and regulator .....	—	—	✓	—	✓	✓
• Modulating gas valve and regulator.....	✓	—	—	—	—	—
• Gasketed blower door (upflow models only).....	✓	✓	✓	✓	✓	—
• Heavy gauge reinforced wrap-around steel cabinet .....	✓	✓	✓	✓	✓	✓
• Humidifier/EAC hook-up capability .....	✓	✓	✓	✓	✓	—
• Inner blower door panel (downflow models only) .....	✓	✓	✓	✓	✓	✓
• Insulated blower compartment 4 sides .....	✓	✓	✓	✓	✓	—
• Integrated solid state control w/self diagnostics .....	✓	—	—	—	—	—
• Left/right condensate drain capability in vertical application .....	✓	✓	✓	✓	✓	✓
• Service diagnostics with faults reported at the user interface .....	✓	—	—	—	—	—
• Lite Port™/Stored diagnostics.....	✓	✓	—	—	—	—
• Manual reset flame roll out switches.....	✓	✓	✓	✓	✓	✓
• Mobile home approved w/BAYMFGH100A.....	—	✓	✓	✓	✓	✓
• Multi-port in shot burners.....	✓	✓	✓	✓	✓	✓
• Painted cabinet single color.....	—	—	—	—	—	✓
• Painted cabinet two tone color.....	✓	✓	✓	✓	✓	—
• Perfect fit door latches (upflow models only).....	✓	—	—	—	—	—
• Service diagnostic capabilities.....	✓	✓	✓	✓	✓	✓
• Slide out blower assembly .....	✓	✓	✓	✓	✓	✓
• Side return duct starter tabs (upflow models only) .....	✓	✓	✓	✓	✓	✓
• Silicon Nitride hot surface igniter .....	✓	✓	✓	✓	✓	✓
• Single wire twinning .....	—	—	✓	✓	✓	—
• Solid burner door (quiet operation) .....	✓	✓	✓	✓	✓	—
• 20 gauge aluminized steel heat exchanger .....	✓	✓	✓	✓	✓	✓
• 24 volt secondary fuse.....	✓	✓	✓	✓	✓	✓
• Multiple heating blower speeds.....	✓	✓	✓	—	—	—
• Two heating blower speeds.....	—	—	—	✓	—	—
• Type 29-4C™ stainless steel secondary heat exchanger.....	✓	✓	✓	✓	✓	✓
• Upflow horizontal left (upflow models only) .....	✓	✓	✓	✓	✓	✓
• Variable speed venter motor.....	✓	✓	—	✓	—	—
• Meets requirements for 2% or less air leakage .....	✓	✓	✓	—	—	—
• <b>Registered limited lifetime heat exchanger warranty and 10-year on all other functional parts (Residential Use)①.....</b>	✓	✓	✓	—	✓	✓
• <b>Optional extended warranties available .....</b>	✓	✓	✓	✓	✓	✓

① Registered Limited Warranty terms are available when you register within 60 days of installation. You can register online at americanstandardair.com or by phone at 800-554-8005; otherwise American Standard Heating & Air Conditioning's Base Limited Warranty terms will apply. Base Limited Warranty information on specific products can be found on ASDealerNet.com.

② Field configurable to 24V non-communicating mode.

Note: Variable speed furnaces should not be twinned and are not approved for twinning applications.

\*Constant torque ECM (electronically commutated motor).

\*\*Constant airflow ECM (electronically commutated motor).

Furnaces



# Platinum 95, Gold 95v, Gold 95, Silver 95, Silver 95h, and American Standard 92 Convertible Gas Furnace

Furnaces

**Airflow Directions:**

Downflow models when placed in horizontal position provide left to right airflow. Upflow models when placed in horizontal position provide right to left airflow.

**Table FUR-8-A — Optional Accessories**

Model Number	Description	Shipping Weight	AUHM/ADHM Modulating 1 or 2 Pipe Variable Speed	AUH2/ADH2 2 Stage 1 or 2 Pipe Variable Speed
BAYBASE205	Downflow subbase for downflow models only	8	✓	✓
BAYFLTR200	External side filter rack	5	✓	✓
BAYFLTR203	Filter kit horiz conversion for 17.5" cabinet	3	✓	✓
BAYFLTR204	Filter kit horiz conversion for 21" cabinet	3	✓	✓
BAYFLTR205	Filter kit horiz conversion for 24.5" cabinet	3	✓	✓
BAYFLTR317①	Cleanable filter for 17.5" cabinet upflow only	2	✓	✓
BAYFLTR321①	Cleanable filter for 21" cabinet upflow only	2	✓	✓
BAYFLTR324①	Cleanable filter for 24.5" cabinet upflow only	2	✓	✓
BAYLPKT210B	Propane conversion kit	1	—	✓
BAYLPKT220B	Propane conversion kit	2	✓	—
BAYLPSS210B	LP Kit with Stainless Steel Burners	1	—	✓
BAYLPSS220B	LP Kit with Stainless Steel Burners	2	✓	—
BAYMFGH100A	Manufactured/mobil home kit	2	—	✓
BAYRACK960A	Filter rack kit for upflow models only (internal)②	5	✓	✓③
BAYAIR30AVENTA	Concentric vent kit for 2, 2½ and 3" ven system	11	✓	✓
BAYVENT200B	Sidewall vent Termination Kit fo Direct vent furnaces	2	✓	✓
BAYVENT500A	Side vent kit for downflow models only	3	✓	✓
BAYACCECOMM101	..AccuClean™ hookup kit for communicating furnaces	1	✓	—

① Contains one (1) high velocity filter.

② Internal filter rack for side or bottom return air. Includes 17 x 25" cleanable filter for use in side return applications. Bottom return applications require different sizes of filters which are not included. Airflow requirements over 1800 CFM require filters on both sides or a side and bottom or bottom only.

③ BAYRACK960 not allowed on right side return on AUH2B080A9V4V\*\* models.

Note: Variable speed furnaces should not be twinned and are not approved for twinning applications.

**Airflow Directions:**

Downflow models when placed in horizontal position provide left to right airflow. Upflow models when placed in horizontal position provide right to left airflow.

**Table FUR-8-B — Optional Accessories**

Model Number	Description	Shipping Weight	AUH1-H/ADH1-H 2 Stage 1 or 2 Pipe	AUH2/ADH2 2 Stage 1 or 2 Pipe PSC	AUH1/ADH1/AUX1/ADX1 1 Stage 1 or 2 Pipe	AUC1/ADC1 1 Stage 1 or 2 Pipe
BAYBASE205	Downflow subbase for downflow models only	8	✓	✓	✓	✓
BAYFLTR200	External side filter rack	5	✓	✓	✓	✓
BAYFLTR203	Filter kit horiz conversion for 17.5" cabinet	3	✓	✓	✓	✓
BAYFLTR204	Filter kit horiz conversion for 21" cabinet	3	✓	✓	✓	✓
BAYFLTR205	Filter kit horiz conversion for 24.5" cabinet	3	✓	✓	✓	✓
BAYFLTR206	Filter kit	2	—	—	✓	✓
BAYFLTR317①	Cleanable filter for 17.5" cabinet upflow only	2	✓	✓	✓	✓
BAYFLTR321①	Cleanable filter for 21" cabinet upflow only	2	✓	✓	✓	✓
BAYFLTR324①	Cleanable filter for 24.5" cabinet upflow only	2	✓	✓	✓	✓
BAYLPKT210B	Propane conversion kit	1	✓	✓	✓	✓
BAYLPSS210B	LP Kit with Stainless Steel Burners	1	✓	✓	✓	✓
BAYMFGH100A	Manufactured/mobil home kit	2	✓	✓	✓	✓
BAYRACK960A	Filter rack kit for upflow models only (internal)②	5	✓	✓	✓	✓
BAYAIR30AVENTA	Concentric vent kit for 2, 2½ and 3" vent system	11	✓	✓	✓	✓
BAYVENT200B	Sidewall vent Termination Kit fo Direct vent furnaces	2	✓	✓	✓	✓
BAYVENT500A	Side vent kit for downflow models only	3	✓	✓	✓	✓

① Contains one (1) high velocity filter.

② Internal filter rack for side or bottom return air. Includes 17 x 25" cleanable filter for use in side return applications. Bottom return applications require different sizes of filters which are not included. Airflow requirements over 1800 CFM require filters on both sides or a side and bottom or bottom only.

Note: Variable speed furnaces should not be twinned and are not approved for twinning applications.

**Table FUR-9-A — High Altitude Pressure Switch 90%**

Model Number	Description	Used With	Shipping Weight
BAYHALT225	1 Switch	AUC080,100C948,120C,ADC080,120C	2
BAYHALT226	1 Switch	AUC,ADC060C	2
BAYHALT227	1 Switch	AUC100C948	2
BAYHALT228	1 Switch	AUC/ADC040C	2
BAYHALT230	1 Switch	AUX/ADX040C,AUX1B040,D100/ADX1B040	2
BAYHALT231	1 Switch	AUX060C,AUX1060C	2
BAYHALT232	1 Switch	AUX080C,AUX1B080C	2
BAYHALT233	1 Switch	AUX100,120C/ADX080,120C,AUX1C100,D120/ADX1B080,D120	2
BAYHALT234	1 Switch	ADX100C,ADX1C100	2
BAYHALT241	1 Switch	ADX060C,ADX1B060	2
BAYHALT245	2 Switches	ADX/AUX/ADY/AUY060-R	2
BAYHALT246	2 Switches	ADX/AUX/ADY/AUY080,100-R	2
BAYHALT247	2 Switches	ADX/AUX/ADY/AUY120-R	2
BAYHALT248	1 Switch	AUD1/ADD1,AUE1/ADE	2
BAYHALT249	1 Switch	AUD2,AUD-R-K,ADD-R-F,ADD2	2

**Table FUR-9-B — High Altitude Pressure Switch 90%**

Model Number	Description	Used With	Shipping Weight
BAYSWT01AHALTA	1 Switch	AUC1B040,AUC1D100,ADC1B040,AUX1B040,AUX1D100,ADX1B040,AUH1B040,ADH1B040,ADH1C085	2
BAYSWT02AHALTA	1 Switch	AUC1B060,AUX1B060	2
BAYSWT03AHALTA	1 Switch	AUC1B080,AUX1B080	2
BAYSWT04AHALTA	1 Switch	AUC1C100,AUC1D120,ADC1B080,ADC1C100,ADC1D120,AUX1C100,AUX1D120,ADX1B080,ADX1D120,AUH1B060	2
BAYSWT05AHALTA	1 Switch	ADX1C100,AUH1B080,AUH1C100,ADH1D110	2
BAYSWT06AHALTA	1 Switch	ADC1B060,ADX1B060	2
BAYSWT07AHALTA	1 Switch	AUH3/AUHMB060,ADH3/ADHMB060,AUX2B060,ADX2B060,AUY060R,ADY060R	2
BAYSWT08AHALTA	1 Switch	AUX2B080,AUX2C100,ADX2B080,ADX2C100,AUY120R,ADY120R,AUH2B080,ADH2B080,AUH2C100,ADH2C100,AUH2D120,ADH2D120,AUH3/AUHMD120,ADH3/ADHMD120	2
BAYSWT09AHALTA	1 Switch	AUX2D120,ADX2D120,AUY080R,ADY080R,AUY100R,ADY100R,AUH3/AUHMB080,ADH3/ADHMB080,AUH3/AUHMC100,ADH/ADHM3C100	2
BAYSWT10AHALTA	1 Switch	AUH2B060A,ADH2B060A	2
BAYSWT11AHALTA	1 Switch	AUH1C080	2
BAYSWT12AHALTA	1 Switch	ADH1B065	2
BAYSWT01AMALTB	1 Switch	AUX1	2

The following changes occurred beginning with serial number 6151:

1. All 2 stage furnace changed from two separate pressure switches to one piggy back switch.
2. The high altitude pressure switches are now piggy back.
3. The new piggy back switches are not interchangeable with the original two switch design.
4. The pressure switch mounting plate is different for the piggy back switches.

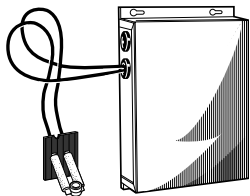

Bonnet Switch TAYPLUS103A

**Table FUR-9-C — Dual Fuel Heat Pump Control Kit<sup>①②</sup>**

Model Number	Case Height	Used With
TAYPLUS103A.....	Heat Pump Control Kit.....	Gas, LP, Oil and Electric Furnaces
TAYSTAT250B.....	Outdoor Thermostat.....	TAYPLUS103A for Restricted Mode

① Factory wired for non-restricted mode, can be wired for restricted mode.

② Applicable for all furnaces with 35 VA or larger low voltage transformer (separate high voltage power not required).

# Platinum 80, Gold 80v, Gold 80, Silver 80h, Silver 80, and American Standard 80 Gas Furnaces Airflow Directions

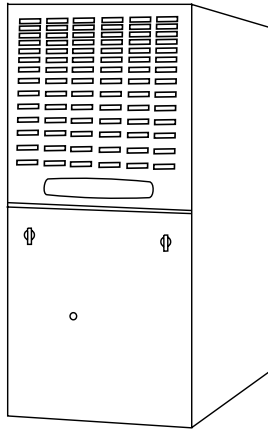

AIR FLOW  
↑  
UPFLOW

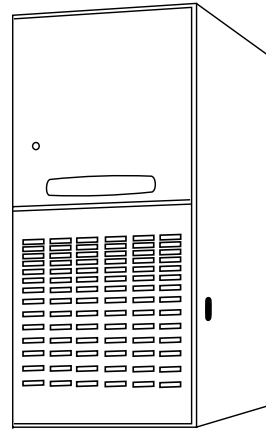

DOWNFLOW  
AIR FLOW  
↓

AIR FLOW ←

UPFLOW, DOWNFLOW, HORIZONTAL LEFT OR RIGHT

AIR FLOW →

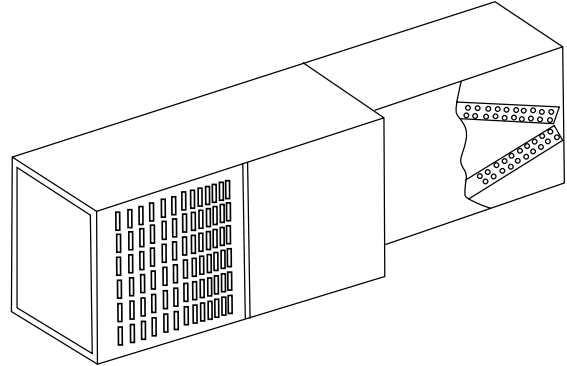
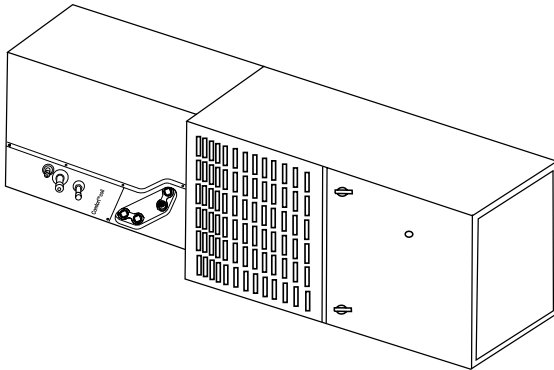

AIR FLOW → UPFLOW

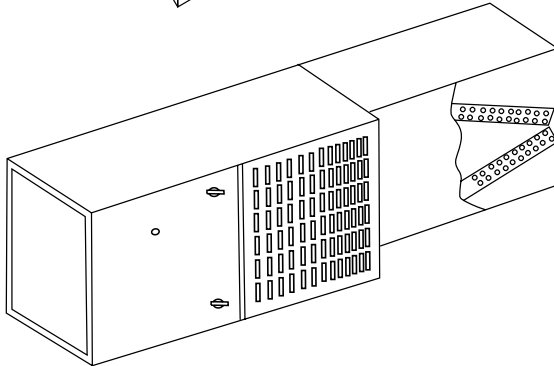

DOWNFLOW ← AIR FLOW

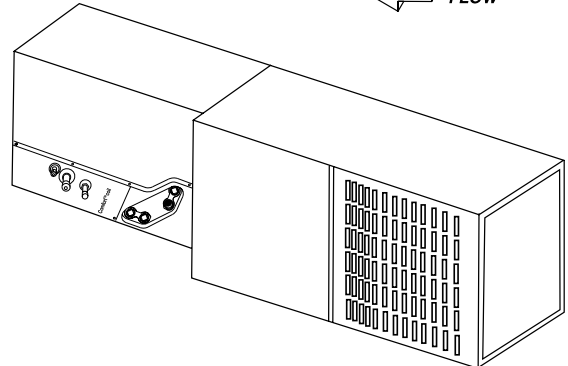

**Note:** The non-condensing, forty inch (40") height furnaces may be laid on either side for horizontal application. Connection brackets for coil/furnace alignment are included with the furnaces. The apex of the coil may point into or away from the airflow.

# Platinum 80 – Communicating Two Stage ECM Variable Speed

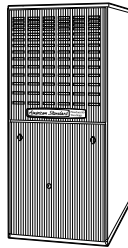

**Platinum 80**

**Table FUR-11-A — Upflow/Horizontal Left or Right Induced Draft Gas Furnace (115/1/60) ①②**

Unit Model No.	Airflow In		Output (Btuh)		AFUE	Flue Size (in)	Ignition Device	Uncrated Dimensions (in.) H x W x D	Shipping Weight (lbs.)	Max Fuse*	Filter Sizes
	Tons	Stage 2	Stage 1	Stage 1							
AUD2B060ACV32A	3	48,000	31,200	80.0	4	Silicon Nitride	40 x 17 <sup>1</sup> / <sub>2</sub> x 28	136	15	17 x 25 x 1	
AUD2B080ACV32A	3	64,000	41,600	80.0	4	Silicon Nitride	40 x 17 <sup>1</sup> / <sub>2</sub> x 28	142	15	17 x 25 x 1	
AUD2C080ACV42A	4	64,000	41,600	80.0	4	Silicon Nitride	40 x 21 x 28	166	15	17 x 25 x 1	
AUD2B100ACV32A	3	80,000	52,000	80.0	4	Silicon Nitride	40 x 17 <sup>1</sup> / <sub>2</sub> x 28	142	15	17 x 25 x 1	
AUD2C100ACV52A	5	79,000	52,000	80.0	4	Silicon Nitride	40 x 21 x 28	166	15	20 x 25 x 1	
AUD2D120ACV52A	5	97,000	62,400	80.0	4	Silicon Nitride	40 x 24 <sup>1</sup> / <sub>2</sub> x 28	193	15	24 x 25 x 1	
AUD2D140ACV52A	5	111,000	72,800	80.0	4	Silicon Nitride	40 x 24 <sup>1</sup> / <sub>2</sub> x 28	197	15	24 x 25 x 1	

Note: Variable speed furnaces should not be twinned and are not approved for twinning applications.



**Platinum 80**

**Table FUR-11-B — Downflow/Horizontal Left or Right Induced Draft Gas Furnace (115/1/60) ①②**

Unit Model No.	Airflow In		Output (Btuh)		AFUE	Flue Size (in)	Ignition Device	Uncrated Dimensions (in.) H x W x D	Shipping Weight (lbs.)	Max Fuse*	Filter Sizes
	Tons	Stage 2	Stage 1	Stage 1							
ADD2B060ACV32A	3	48,000	31,200	80.0	4	Silicon Nitride	40 x 17 <sup>1</sup> / <sub>2</sub> x 28	140	15	(2) 14 x 20 x 1	
ADD2B080ACV32A	3	63,000	41,600	80.0	4	Silicon Nitride	40 x 17 <sup>1</sup> / <sub>2</sub> x 28	146	15	(2) 14 x 20 x 1	
ADD2C100ACV52A	5	81,000	52,000	80.0	4	Silicon Nitride	40 x 21 x 28	166	15	(2) 16 x 20 x 1	
ADD2D120ACV52A	5	95,000	62,400	80.0	4	Silicon Nitride	40 x 24 <sup>1</sup> / <sub>2</sub> x 28	197	15	(2) 16 x 20 x 1	

Note: Variable speed furnaces should not be twinned and are not approved for twinning applications.

① Must use ACONT900 or AZONE950 control in communicating mode.

② Field convertible to 24V non-communicating.

\* Information subject to change. Please confirm with current Product Data/Service Facts for current factory production.

\*\* Filters are not shipped with furnace.

# Gold 80v – Two Stage ECM Variable Speed

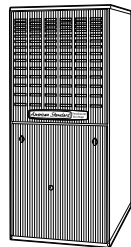

**Gold 80v**

**Table FUR-11-C — Upflow/Horizontal Left or Right Induced Draft Gas Furnace (115/1/60) ②**

Unit Model No.	Airflow In		Output (Btuh)		AFUE	Flue Size (in)	Ignition Device	Uncrated Dimensions (in.) H x W x D	Shipping Weight (lbs.)	Max Fuse*	Filter Sizes
	Tons	Stage 2	Stage 1	Stage 1							
AUD2B060A9V3VB	3	48,000	31,200	80.0	4	Silicon Nitride	40 x 17 <sup>1</sup> / <sub>2</sub> x 28	136	15	17 x 25 x 1	
AUD2B080A9V3VB	3	64,000	41,600	80.0	4	Silicon Nitride	40 x 17 <sup>1</sup> / <sub>2</sub> x 28	142	15	17 x 25 x 1	
AUD2C080A9V4VB	4	64,000	41,600	80.0	4	Silicon Nitride	40 x 21 x 28	166	15	17 x 25 x 1	
AUD2C080B9V4VB ①	4	64,000	41,600	80.0	4	Silicon Nitride	40 x 21 x 28	166	15	17 x 25 x 1	
AUD2B100A9V3VB	3	80,000	52,000	80.0	4	Silicon Nitride	40 x 17 <sup>1</sup> / <sub>2</sub> x 28	142	15	17 x 25 x 1	
AUD2C100A9V5VB	5	79,000	52,000	80.0	4	Silicon Nitride	40 x 21 x 28	166	20	20 x 25 x 1	
AUD2C100B9V5VB ①	5	79,000	52,000	80.0	4	Silicon Nitride	40 x 21 x 28	166	20	20 x 25 x 1	
AUD2D120A9V5VB	5	97,000	62,400	80.0	4	Silicon Nitride	40 x 24 <sup>1</sup> / <sub>2</sub> x 28	193	20	24 x 25 x 1	
AUD2D120B9V5VB ①	5	97,000	62,400	80.0	4	Silicon Nitride	40 x 24 <sup>1</sup> / <sub>2</sub> x 28	193	20	24 x 25 x 1	
AUD2D140A9V5VB	5	111,000	72,800	80.0	4	Silicon Nitride	40 x 24 <sup>1</sup> / <sub>2</sub> x 28	197	20	24 x 25 x 1	

① Model has high efficiency blower assembly.

② This furnace family uses a two speed draft inducer.

Note: Variable speed furnaces should not be twinned and are not approved for twinning applications.

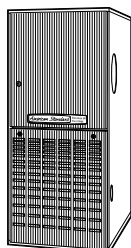

**Gold 80v**

**Table FUR-11-D — Downflow/Horizontal Left or Right Induced Draft Gas Furnace (115/1/60) ②**

Unit Model No.	Airflow In		Output (Btuh)		AFUE	Flue Size (in)	Ignition Device	Uncrated Dimensions (in.) H x W x D	Shipping Weight (lbs.)	Max Fuse*	Filter Sizes
	Tons	Stage 2	Stage 1	Stage 1							
ADD2B060A9V3VA	3	48,000	31,200	80.0	4	Silicon Nitride	40 x 17 <sup>1</sup> / <sub>2</sub> x 28	140	15	(2) 14 x 20 x 1	
ADD2B080A9V3VA	3	63,000	41,600	80.0	4	Silicon Nitride	40 x 17 <sup>1</sup> / <sub>2</sub> x 28	146	15	(2) 14 x 20 x 1	
ADD2C100A9V5VA	5	81,000	52,000	80.0	4	Silicon Nitride	40 x 21 x 28	166	20	(2) 16 x 20 x 1	
ADD2D120A9V5VA	5	95,000	62,400	80.0	4	Silicon Nitride	40 x 24 <sup>1</sup> / <sub>2</sub> x 28	197	20	(2) 16 x 20 x 1	

Note: Variable speed furnaces should not be twinned and are not approved for twinning applications.

\* Information subject to change. Please confirm with current Product Data/Service Facts for current factory production.

② This furnace family uses a two speed draft inducer.

# Gold 80 – Two Stage

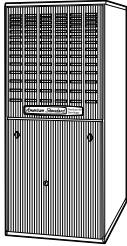

**Gold 80**

**Table FUR-12-A — Upflow/Horizontal, Left or Right Induced Draft Gas Furnace (115/1/60)**

Unit Model No.	Airflow In Tons	Output (Btuh) Stage 2	Output (Btuh) Stage 1	AFUE	Flue Size (in.)	Ignition Device	Uncrated Dimensions (in.) H x W x D	Shipping Weight (lbs.)	Max Fuse*	Filter** Sizes
AUD2A040A9242A	2	32,000	20,800	80.0	4	Silicon Nitride	40 x 14½ x 28	119	15	17 x 25 x 1
AUD2A060A9362A	3	47,000	31,200	80.0	4	Silicon Nitride	40 x 14½ x 28	127	15	17 x 25 x 1
AUD2B060A9362A	3	47,000	31,200	80.0	4	Silicon Nitride	40 x 17½ x 28	132	15	17 x 25 x 1
AUD2B080A9362A	3	63,000	41,600	80.0	4	Silicon Nitride	40 x 17½ x 28	142	15	17 x 25 x 1
AUD2B080A9482A	4	63,000	41,600	80.0	4	Silicon Nitride	40 x 17½ x 28	142	15	17 x 25 x 1
AUD2B100A9362A	3	79,000	52,000	80.0	4	Silicon Nitride	40 x 17½ x 28	151	15	17 x 25 x 1
AUD2C100A9482A	4	79,000	52,000	80.0	4	Silicon Nitride	40 x 21 x 28	162	15	20 x 25 x 1
AUD2C100A9602A	5	80,000	52,000	80.0	4	Silicon Nitride	40 x 21 x 28	162	20	20 x 25 x 1
AUD2D100A9602A	5	80,000	52,000	80.0	4	Silicon Nitride	40 x 24½ x 28	175	20	24 x 25 x 1
AUD2C120A9542A	4.5	95,000	62,400	80.0	4	Silicon Nitride	40 x 21 x 28	176	20	20 x 25 x 1
AUD2D120A9602A	5	95,000	62,400	80.0	4	Silicon Nitride	40 x 24½ x 28	186	20	24 x 25 x 1
AUD2D140A9602A	5	112,000	72,800	80.0	4	Silicon Nitride	40 x 24½ x 28	192	20	24 x 25 x 1

Furnaces

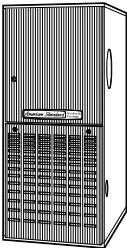

**Gold 80**

**Table FUR-12-B — Downflow/Horizontal Left or Right Induced Draft (115/1/60)**

Unit Model No.	Airflow In Tons	Output (Btuh) Stage 2	Output (Btuh) Stage 1	AFUE	Flue Size (in.)	Ignition Device	Uncrated Dimensions (in.) H x W x D	Shipping Weight (lbs.)	Max Fuse*	Filter** Sizes
ADD2A040A9242A	2	32,000	20,800	80.0	4	Silicon Nitride	40 x 14½ x 28	125	15	(2) 14 x 20 x 1
ADD2A060A9362A	3	47,000	31,200	80.0	4	Silicon Nitride	40 x 14½ x 28	135	15	(2) 14 x 20 x 1
ADD2B060A9362A	3	48,000	31,200	80.0	4	Silicon Nitride	40 x 17½ x 28	140	15	(2) 14 x 20 x 1
ADD2B080A9362A	3	64,000	41,600	80.0	4	Silicon Nitride	40 x 17½ x 28	152	15	(2) 14 x 20 x 1
ADD2B100A9482A	4	79,000	52,000	80.0	4	Silicon Nitride	40 x 17½ x 28	157	15	(2) 14 x 20 x 1
ADD2C100A9482A	4	79,000	52,000	80.0	4	Silicon Nitride	40 x 21 x 28	166	15	(2) 16 x 20 x 1
ADD2C100A9602A	5	79,000	52,000	80.0	4	Silicon Nitride	40 x 21 x 28	168	20	(2) 16 x 20 x 1
ADD2D120A9602A	5	94,000	62,400	80.0	4	Silicon Nitride	40 x 24½ x 28	189	20	(2) 16 x 20 x 1
ADD2D140A9602A	5	112,000	72,800	80.0	4	Silicon Nitride	40 x 24½ x 28	196	20	(2) 16 x 20 x 1

\* Information subject to change. Please confirm with current Product Data/Service Facts for current factory production.

\*\* Filters are not shipped with furnace.

# Silver 80h – Single Stage with ECM Multi-Speed Motor

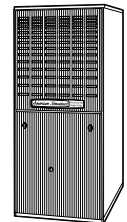

**Silver 80h**

**Table FUR-12-C — Upflow Horizontal, Left or Right Induced Draft Gas Furnace (115/1/60)**

Unit Model No.	Airflow In Tons	Nominal Output (Btuh)	AFUE	Flue Size (in.)	Ignition Device	Uncrated Dimensions (in.) H x W x D	Shipping Weight (lbs.)	Max Fuse*	Filter Sizes
AUD1A040A9H21B	2	32,000	80.0	4	Silicon Nitride	40 x 14½ x 28	119	15	17 x 25 x 1
AUD1B060A9H31B	3	47,000	80.0	4	Silicon Nitride	40 x 17½ x 28	127	15	17 x 25 x 1
AUD1B080A9H31B	3	63,000	80.0	4	Silicon Nitride	40 x 17½ x 28	142	15	17 x 25 x 1
AUD1C080A9H41B	4	64,000	80.0	4	Silicon Nitride	40 x 21 x 28	142	15	20 x 25 x 1
AUD1B100A9H31B	3	79,000	80.0	4	Silicon Nitride	40 x 17½ x 28	151	15	17 x 25 x 1
AUD1C100A9H51B	5	79,000	80.0	4	Silicon Nitride	40 x 21 x 28	162	20	20 x 25 x 1
AUD1D120A9H51B	5	96,000	80.0	4	Silicon Nitride	40 x 24½ x 28	186	20	24 x 25 x 1
AUD1D140A9H51B	5	111,000	80.0	4	Silicon Nitride	40 x 24½ x 28	193	20	24 x 25 x 1

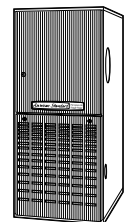

**Silver 80h**

**Table FUR-12-D — Downflow Horizontal, Left or Right Induced Draft Gas Furnace (115/1/60)**

Unit Model No.	Airflow In Tons	Nominal Output (Btuh)	AFUE	Flue Size (in.)	Ignition Device	Uncrated Dimensions (in.) H x W x D	Shipping Weight (lbs.)	Max Fuse*	Filter Sizes
ADD1B060A9H31B	3	48,000	80.0	4	Silicon Nitride	40 x 17½ x 28	129	15	(2) 14 x 20 x 1
ADD1B080A9H31B	3	64,000	80.0	4	Silicon Nitride	40 x 17½ x 28	146	15	(2) 14 x 20 x 1
ADD1C100A9H51B	5	81,000	80.0	4	Silicon Nitride	40 x 21 x 28	167	20	(2) 16 x 20 x 1
ADD1D120A9H51B	5	96,000	80.0	4	Silicon Nitride	40 x 24½ x 28	189	20	(2) 16 x 20 x 1

Note: Silver 80h furnaces have constant torque ECM motors

For complete equipment / combination selections, installation instructions and warranty information, please refer to Product Data/Ratings and/or Installers Guides and Limited Warranty Handbooks.

# Silver 80 – Single Stage

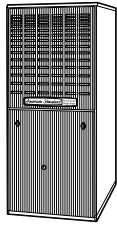

Silver 80

**Table FUR-13-A — Upflow/Horizontal Left or Right Induced Draft Gas Furnace (115/1/60)**

Unit Model No.	Airflow In Tons	Nominal Output (Btuh)	AFUE	Flue Size (in.)	Ignition Device	Uncrated Dimensions (in.) H x W x D	Shipping Weight (lbs.)	Max Fuse*	Filter** Sizes
AUD1A040A9241A	2	32,000	80.0	4	Silicon Nitride	40 x 14 <sup>1</sup> / <sub>2</sub> x 28	119	15	17 x 25 x 1
AUD1A040A9301A	2 <sup>1</sup> / <sub>2</sub>	32,000	80.0	4	Silicon Nitride	40 x 14 <sup>1</sup> / <sub>2</sub> x 28	122	15	17 x 25 x 1
AUD1A060A9241A	2	47,000	80.0	4	Silicon Nitride	40 x 14 <sup>1</sup> / <sub>2</sub> x 28	124	15	17 x 25 x 1
AUD1A060A9361A	3	47,000	80.0	4	Silicon Nitride	40 x 14 <sup>1</sup> / <sub>2</sub> x 28	127	15	17 x 25 x 1
AUD1B060A9361A	3	47,000	80.0	4	Silicon Nitride	40 x 17 <sup>1</sup> / <sub>2</sub> x 28	132	15	17 x 25 x 1
AUD1B080A9241A	2	64,000	80.0	4	Silicon Nitride	40 x 17 <sup>1</sup> / <sub>2</sub> x 28	139	15	17 x 25 x 1
AUD1B080A9361A	3	63,000	80.0	4	Silicon Nitride	40 x 17 <sup>1</sup> / <sub>2</sub> x 28	142	15	17 x 25 x 1
AUD1B080A9481A	4	64,000	80.0	4	Silicon Nitride	40 x 17 <sup>1</sup> / <sub>2</sub> x 28	142	15	17 x 25 x 1
AUD1C080A9601A	5	64,000	80.0	4	Silicon Nitride	40 x 21 x 28	154	20	20 x 25 x 1
AUD1B100A9361A	3	79,000	80.0	4	Silicon Nitride	40 x 17 <sup>1</sup> / <sub>2</sub> x 28	151	15	17 x 25 x 1
AUD1B100A9451A	4	80,000	80.0	4	Silicon Nitride	40 x 17 <sup>1</sup> / <sub>2</sub> x 28	153	15	17 x 25 x 1
AUD1C100A9481A	4	79,000	80.0	4	Silicon Nitride	40 x 21 x 28	162	15	20 x 25 x 1
AUD1C100A9601A	5	79,000	80.0	4	Silicon Nitride	40 x 21 x 28	162	20	20 x 25 x 1
AUD1D100A9721A	6	80,000	80.0	4	Silicon Nitride	40 x 24 <sup>1</sup> / <sub>2</sub> x 28	175	20	24 x 25 x 1
AUD1C120A9541A	5	96,000	80.0	4	Silicon Nitride	40 x 21 x 28	176	20	20 x 25 x 1
AUD1D120A9601A	5	96,000	80.0	4	Silicon Nitride	40 x 24 <sup>1</sup> / <sub>2</sub> x 28	186	20	24 x 25 x 1
AUD1D140A9601A	5	111,000	80.0	4	Silicon Nitride	40 x 24 <sup>1</sup> / <sub>2</sub> x 28	193	20	24 x 25 x 1

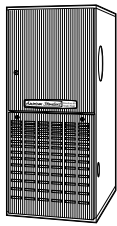

Silver 80

**Table FUR-13-B — Downflow/Horizontal Left or Right Induced Draft Gas Furnace (115/1/60)**

Unit Model No.	Airflow In Tons	Nominal Output (Btuh)	AFUE	Flue Size (in.)	Ignition Device	Uncrated Dimensions (in.) H x W x D	Shipping Weight (lbs.)	Max Fuse*	Filter** Sizes
ADD1A060A9241A	2	48,000	80.0	4	Silicon Nitride	40 x 14 <sup>1</sup> / <sub>2</sub> x 28	129	15	(2) 14 x 20 x 1
ADD1A060A9361A	3	48,000	80.0	4	Silicon Nitride	40 x 14 <sup>1</sup> / <sub>2</sub> x 28	129	15	(2) 14 x 20 x 1
ADD1B060A9361A	3	48,000	80.0	4	Silicon Nitride	40 x 17 <sup>1</sup> / <sub>2</sub> x 28	134	15	(2) 14 x 20 x 1
ADD1B080A9361A	3	64,000	80.0	4	Silicon Nitride	40 x 17 <sup>1</sup> / <sub>2</sub> x 28	146	15	(2) 14 x 20 x 1
ADD1B080A9451A	4	64,000	80.0	4	Silicon Nitride	40 x 17 <sup>1</sup> / <sub>2</sub> x 28	146	15	(2) 14 x 20 x 1
ADD1B100A9451A	4	80,000	80.0	4	Silicon Nitride	40 x 17 <sup>1</sup> / <sub>2</sub> x 28	156	15	(2) 14 x 20 x 1
ADD1C100A9481A	4	80,000	80.0	4	Silicon Nitride	40 x 21 x 28	166	15	(2) 16 x 20 x 1
ADD1C100A9541A	5	81,000	80.0	4	Silicon Nitride	40 x 21 x 28	167	20	(2) 16 x 20 x 1
ADD1C120A9541A	5	96,000	80.0	4	Silicon Nitride	40 x 21 x 28	177	20	(2) 16 x 20 x 1
ADD1D120A9601A	5	96,000	80.0	4	Silicon Nitride	40 x 24 <sup>1</sup> / <sub>2</sub> x 28	189	20	(2) 16 x 20 x 1
ADD1D140A9601A	5	113,000	80.0	4	Silicon Nitride	40 x 24 <sup>1</sup> / <sub>2</sub> x 28	196	20	(2) 16 x 20 x 1

\* Information subject to change. Please confirm with current Product Data/Service Facts for current factory production.

\*\* Filters are not shipped with furnace.

Furnaces

# American Standard 80 – Single Stage

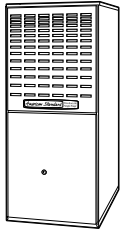

Sliver SI

**Table FUR-14-A — Upflow/Horizontal Left or Right Induced Draft Gas Furnace (115/1/60)**

Unit Model No.	Airflow In Tons	Nominal Output (Btuh)	AFUE	Flue Size (in.)	Ignition Device	Uncrated Dimensions (in.) H x W x D	Shipping Weight (lbs.)	Max Fuse*	Filter** Sizes
AUE1A040A9241A	2	31,000	80.0	4	Silicon Nitride	40 x 14 <sup>1</sup> / <sub>2</sub> x 28	119	15	16 x 25 x 1
AUE1A060A9241A	2	47,000	80.0	4	Silicon Nitride	40 x 14 <sup>1</sup> / <sub>2</sub> x 28	124	15	16 x 25 x 1
AUE1A060A9361A	3	47,000	80.0	4	Silicon Nitride	40 x 14 <sup>1</sup> / <sub>2</sub> x 28	127	15	16 x 25 x 1
AUE1B060A9361A	3	47,000	80.0	4	Silicon Nitride	40 x 17 <sup>1</sup> / <sub>2</sub> x 28	132	15	17 x 25 x 1
AUE1B080A9361A	3	63,000	80.0	4	Silicon Nitride	40 x 17 <sup>1</sup> / <sub>2</sub> x 28	142	15	17 x 25 x 1
AUE1B080A9481A	4	64,000	80.0	4	Silicon Nitride	40 x 17 <sup>1</sup> / <sub>2</sub> x 28	142	15	17 x 25 x 1
AUE1B100A9361A	3	79,000	80.0	4	Silicon Nitride	40 x 17 <sup>1</sup> / <sub>2</sub> x 28	151	15	17 x 25 x 1
AUE1C100A9481A	4	79,000	80.0	4	Silicon Nitride	40 x 21 x 28	162	15	20 x 25 x 1
AUE1C100A9601A	5	79,000	80.0	4	Silicon Nitride	40 x 21 x 28	162	20	20 x 25 x 1
AUE1D120A9601A	5	96,000	80.0	4	Silicon Nitride	40 x 24 <sup>1</sup> / <sub>2</sub> x 28	186	20	24 x 25 x 1
AUE1D140A9601A	5	111,000	80.0	4	Silicon Nitride	40 x 24 <sup>1</sup> / <sub>2</sub> x 28	193	20	24 x 25 x 1

**Table FUR-14-B — Downflow/Horizontal Left or Right Induced Draft Gas Furnace (115/1/60)**

Unit Model No.	Airflow In Tons	Nominal Output (Btuh)	AFUE	Flue Size (in.)	Ignition Device	Uncrated Dimensions (in.) H x W x D	Shipping Weight (lbs.)	Max Fuse*	Filter** Sizes
ADE1A060A9361A	3	48,000	80.0	4	Silicon Nitride	40 x 14 <sup>1</sup> / <sub>2</sub> x 28	129	15 (2)	14 x 20 x 1
ADE1B060A9361A	3	48,000	80.0	4	Silicon Nitride	40 x 17 <sup>1</sup> / <sub>2</sub> x 28	134	15 (2)	14 x 20 x 1
ADE1B080A9451A	4	64,000	80.0	4	Silicon Nitride	40 x 17 <sup>1</sup> / <sub>2</sub> x 28	146	15 (2)	14 x 20 x 1
ADE1B100A9451A	4	80,000	80.0	4	Silicon Nitride	40 x 17 <sup>1</sup> / <sub>2</sub> x 28	156	15 (2)	14 x 20 x 1
ADE1C100A9601A	5	81,000	80.0	4	Silicon Nitride	40 x 21 x 28	167	20 (2)	16 x 20 x 1
ADE1D120A9601A	5	96,000	80.0	4	Silicon Nitride	40 x 24 <sup>1</sup> / <sub>2</sub> x 28	189	20 (2)	16 x 20 x 1

\* Information subject to change. Please confirm with current Product Data/Service Facts for current factory production.

\*\* Filters are not shipped with furnace.

# Platinum 80, Gold 80v, Gold 80, Silver 80h, Silver 80, and American Standard 80 Convertible Gas Furnaces

Furnaces

	AUD2-ACV/ ADD2-ACV 2 Stage 1 or 2 Pipe ②	AUD2-9V ADD2-9V 2 Stage ②	AUD2/ ADD2 2 Stage	AUD1-H/ ADD1-H 1 Stage High Efficiency	AUD1/ ADD1 1 Stage	AUE1/ ADE1 1 Stage
<b>Table FUR-15-A — Features</b>						
• <b>Comfort-R™</b> enhanced mode (cooling).....	✓	✓	—	—	—	—
• <b>AccuLink™</b> system .....	✓	—	—	—	—	—
• Can be connected in communicating or 24V non-communicating modes .....	✓	—	—	—	—	—
• User interface for system configuration - Easy to use navigation buttons and plain text for clear description of features.....	✓	—	—	—	—	—
• Adjustable heating fan off timing .....	✓	✓	✓	✓	✓	✓
• Alternate bottom/left/right return air (upflow models only) .....	✓	✓	✓	✓	✓	✓
• Attractive color accents .....	✓	✓	✓	✓	✓	✓
• Blower door safety switch.....	✓	✓	✓	✓	✓	✓
• Bottom Panel (upflow models only) .....	✓	✓	✓	✓	✓	✓
• Cleanable/reusable high velocity filters.....	✓	✓	✓	✓	✓	✓
• Common vent capability.....	✓	✓	✓	✓	✓	✓
• Complete front service access.....	✓	✓	✓	✓	✓	✓
• Direct drive, multi-speed (PSC) blower motor.....	—	—	✓	—	✓	✓
• Direct drive, multi-speed ECM blower motor (high efficiency)* .....	—	—	—	✓	—	—
• Direct drive, variable speed ECM blower motor** .....	✓	✓	—	—	—	—
• Gasketed blower door .....	✓	✓	✓	✓	✓	✓
• Heavy gauge reinforced wrap-around steel cabinet .....	✓	✓	✓	✓	✓	✓
• Horizontal left/right without conversion required .....	✓	✓	✓	✓	✓	✓
• Humidifier/EAC hook-up capability .....	✓	✓	✓	✓	✓	✓
• Inner blower door panel (downflow models only).....	✓	✓	✓	✓	✓	✓
• Insulated blower compartment 4 sides (upflow models only) .....	✓	✓	✓	✓	✓	✓
• Integrated solid state control w/self diagnostics.....	✓	✓	✓	✓	✓	✓
• Left/right gas connection.....	✓	✓	✓	✓	✓	✓
• Manual reset flame roll out switches.....	✓	✓	✓	✓	✓	✓
• Masonry Chimney Venting w/BAYVENT800B.....	✓	✓	✓	✓	✓	✓
• Multi-port in shot burners .....	✓	✓	✓	✓	✓	✓
• Painted cabinet single color .....	—	—	—	—	—	—
• Perfect fit door latches (upflow models only) .....	✓	✓	✓	✓	✓	✓
• Right or left hand side knock out for venting (downflow models only).....	✓	✓	✓	✓	✓	✓
• Selectable cooling fan off delay eliminates need for time delay relay BAY24X045.....	③	✓	✓	✓	✓	✓
• Service diagnostic capabilities .....	✓	✓	✓	✓	✓	✓
• Service diagnostics with faults reported at the user interface .....	✓	—	—	—	—	—
• Side return starter tabs (upflow models only).....	✓	✓	✓	✓	✓	✓
• Silicon Nitride hot surface igniter with adaptive heat up .....	✓	✓	✓	✓	✓	✓
• Single door filter access .....	✓	✓	✓	✓	✓	✓
• Single wire twinning .....	—	—	—	—	—	—
• Slide out blower assembly.....	✓	✓	✓	✓	✓	✓
• 3-way vent option on downflow models (top, right or left) (downflow models only).....	—	✓	✓	✓	✓	✓
• 20 gauge aluminized steel heat exchanger .....	✓	✓	✓	✓	✓	✓
• 24 volt secondary fuse .....	—	✓	✓	—	✓	✓
• Multiple heating blower speeds.....	✓	✓	✓	—	—	—
• Two speed venter motor.....	✓	✓	✓	—	—	—
• Two tone color .....	✓	✓	✓	✓	✓	✓
• Two-stage gas valve.....	✓	✓	✓	—	—	—
• <b>Registered limited lifetime heat exchanger warranty and 10-year on all other functional parts (Residential Use)①</b> .....	✓	✓	—	—	—	—
• <b>Registered 20-year heat exchanger limited warranty and 10-year on all other functional parts (Residential Use)</b> .....	—	—	✓	✓	✓	✓
• <b>Optional extended warranties available</b> .....	✓	✓	✓	✓	✓	✓

① Registered Limited Warranty terms are available when you register within 60 days of installation. You can register online at americanstandardair.com or by phone at 800-554-8005; otherwise American Standard Heating & Air Conditioning's Base Limited Warranty terms will apply. Base Limited Warranty information on specific products can be found on ASDealerNet.com.

② Variable Speed

③ Selectable through thermostat

Note: Variable speed furnaces should not be twinned and are not approved for twinning applications.

\*Constant torque ECM (electronically commutated motor).

\*\*Constant airflow ECM (electronically commutated motor).



# Platinum 80, Gold 80v, Gold 80, Silver 80h, Silver 80, and American Standard 80 Convertible Gas Furnaces

Furnaces

**Table FUR-16-A — Optional Accessories**

Model Number	Description	Shipping Weight	AUD2-ACV/ADD2-ACV 2 Stage Variable Speed	AUD2-9V/ ADD2-9V 2-Stg. Variable Speed
BAYBASE205	Downflow subbase for downflow models only	8	✓	✓
BAYFLTR200	Side Filter Rack (External)	5	✓	✓
BAYFLTR203	Filter kit horiz conversion for 17.5" cabinet	3	✓	✓
BAYFLTR204	Filter kit horiz conversion for 21" cabinet	3	✓	✓
BAYFLTR205	Filter kit horiz conversion or 24.5" cabinet	3	✓	✓
BAYFLTR206	Filter Access Door Kit	2	✓	✓
BAYFLTR321①	Cleanable filter for 21" cabinet upflow only	2	✓	✓
BAYFLTR324①	Cleanable filter for 24.5" cabinet upflow only	2	✓	✓
BAYLPKT210B	Propane conversion kit	1	✓	✓
BAYLPSS210B	LP Kit with Stainless Steel Burners	1	✓	✓
BAYRACK960A②	Filter Rack Kit for upflow models only (internal)	5	✓	✓
BAYVENT800B	Masonry chimney vent kit	2	✓	✓

① Contains one (1) high velocity filter.

② Internal filter rack for side or bottom return air. Includes 17 x 25" cleanable filter for use in side return applications. Bottom return applications require different sizes of filters which are not included. Airflow requirements over 1800 CFM require filters on both sides or a side and bottom or bottom only.

**Table FUR-16-B — Optional Accessories**

Model Number	Description	Shipping Weight	AUD2/ADD2 2 Stage	AUD1-H/ADD1-H 1 Stage High Efficiency	AUD1/ADD1 1 Stage	AUE1/ADE1 1 Stage
BAYBASE205	Downflow subbase for downflow models only	8	✓	✓	✓	✓
BAYFLTR200	Side Filter Rack (External)	5	✓	✓	✓	—
BAYFLTR203	Filter kit horiz conversion for 17.5" cabinet	3	✓	✓	✓	✓
BAYFLTR204	Filter kit horiz conversion for 21" cabinet	3	✓	✓	✓	✓
BAYFLTR205	Filter kit horiz conversion or 24.5" cabinet	3	✓	✓	✓	✓
BAYFLTR206	Filter Access Door Kit	2	✓	✓	✓	✓
BAYFLTR317①	Cleanable filter for 14.5" and 17.5" cabinet upflow only	2	✓	✓	✓	✓
BAYFLTR321①	Cleanable filter for 21" cabinet upflow only	2	✓	✓	✓	✓
BAYFLTR324①	Cleanable filter for 24.5" cabinet upflow only	2	✓	✓	✓	✓
BAYLPKT210B	Propane conversion kit	1	✓	✓	✓	✓
BAYLPSS210B	LP Kit with Stainless Steel Burners	1	✓	✓	✓	✓
BAYRACK960A②	Filter Rack Kit for upflow models only (internal)	5	✓	✓	✓	✓
BAYVENT800B	Masonry chimney vent kit	2	✓	✓	✓	✓

① Contains one (1) high velocity filter.

② Internal filter rack for side or bottom return air. Includes 17 x 25" cleanable filter for use in side return applications. Bottom return applications require different sizes of filters which are not included. Airflow requirements over 1800 CFM require filters on both sides or a side and bottom or bottom only.

Note: Variable speed furnaces should not be twinned and are not approved for twinning applications.

## Special Use Furnace Accessories

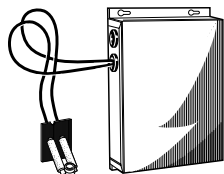

Bonnet Switch  
TAYPLUS103A

**Table FUR-16-C — High Altitude Pressure Switch 80%**

Model Number	Description	Used With	Shipping Weight
BAYHALT248	1 Switch	AUD1,ADD1,AUE1,ADE1	2
BAYHALT249	1 Switch	AUD-R-K,ADD-R-F,AUD2,ADD2	2

**Table FUR-16-D — Dual Fuel Heat Pump Control Kit①②**

Model Number	Case Height	Used With
TAYPLUS103A	Heat Pump Control Kit	Gas, LP, Oil and Electric Furnaces
TAYSTAT250B	Outdoor Thermostat	TAYPLUS103A for Restricted Mode

① Factory wired for non-restricted mode, can be wired for restricted mode.

② Applicable for all furnaces with 35 VA or larger low voltage transformer (separate high voltage power not required).

## Ordering Information

---

### Variable and Non-Variable Speed High Efficiency Oil Furnaces

American Standard Oil Furnaces are available from your local distributor.

For availability and support, contact your local distributor.



# AccuClean™ Whole Home Air Cleaner

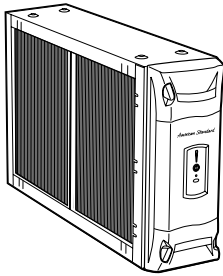

## AccuClean™ Whole Home Air Cleaner:

- **AccuClean™** removes up to 99.98% of allergens from the filtered air
- Removes particles down to .01 micron in size
- Outperforms HEPA, and up to 100 times more effective than a standard 1" filter
- Constructed of heavy 18 gage metal to protect the filter and internal electronics
- Power door provides easy access to internal components and features a filter status display as well as safety interlocks that automatically shut down the power when the door is opened for maintenance or cleaning
- Designed for flush fit on both sides and rear of equipment cabinet
- No transitions required on **AccuClean™** applications
- Gaskets included with the air cleaner
- **AccuLink™** communicating or 24 volt capability
- **Base Limited Warranty 5-years**
- **Registered Limited Warranty 10-years**

**Table IAQ-1-A – Air Handler – 24 Volt AccuClean™ Whole Home Air Cleaner**

Model Number	Airflow Range	AccuClean™ Air Handler Width	Uncrated Dimensions(in.) H x W x D	Shipping Weight
AFD175CLAH000E	300-1200	17½ inch	7½ x 17½ x 21	37
AFD215CLAH000E	300-1200	21½ inch	7½ x 21½ x 21	42
AFD235CLAH000E	350-1600	23½ inch	7½ x 23½ x 21	44
AFD260CLAH000E	400-2000	26 inch	7½ x 26 x 21	46

**Table IAQ-1-B – Upflow / Side Return Furnace – 24 Volt AccuClean™ Whole Home**

Model Number	Airflow Range	AccuClean™ Furnace Width	Uncrated Dimensions(in.) H x W x D	Shipping Weight
AFD145CLFR000E	300-1200	14½ inch <sup>①</sup>	7½ x 14½ x 27	39
AFD175CLFR000E	300-1600	17½ inch <sup>①</sup>	7½ x 17½ x 27	43
AFD210CLFR000E	300-2000	21 inch <sup>②</sup>	7½ x 21 x 27	47
AFD245CLFR000E	400-2000	24½ inch <sup>②</sup>	7½ x 24½ x 27	49

**Table IAQ-1-C – Downflow Furnace – 24 Volt AccuClean™ Whole Home**

Model Number	Airflow Range	AccuClean™ Furnace Width	Uncrated Dimensions(in.) H x W x D	Shipping Weight
AFD14DCLFR000E	300-1200	14½ inch	7½ x 14½ x 21	33
AFD17DCLFR000E	300-1600	17½ inch	7½ x 17½ x 21	37
AFD21DCLFR000E	300-2000	21 inch	7½ x 21 x 21	41
AFD24DCLFR000E	400-2000	24½ inch	7½ x 24½ x 21	45

**Table IAQ-1-D — Accessories – AccuClean™ Whole Home**

Model Number	Description	Used With	Shipping Weight
BAYTRANS12024	120 to 24 Volt Transformer	All AFD Air Cleaners	6

① Side return no transition required.

② Side return transition required.

## Perfect Fit™ Media Filters

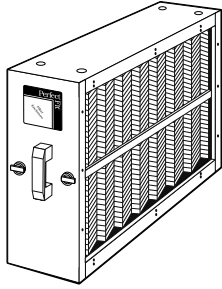

- Four sizes to flush fit bottom of American Standard furnaces
- TFM175 (17½") bottom return model can be used for a **Perfect Fit™** side return on all furnace models
- Air Cleaners designed for flush fit on both sides and rear of equipment cabinet
- All service and access is from the front of the air cleaner
- **Air-Tite™** Door construction eliminates air leaks, improves air quality and keeps operating costs low
- Gaskets included with the air cleaner

**Table IAQ-2-A– Air Handler Perfect Fit™ High Efficiency Air Cleaner With Five (5) Inch Expandable Media Filter**

Model Number	Airflow Range	Perfect Fit™ Air Handler Width	Uncrated Dimensions(in.) H x W x D	Shipping Weight	Return Air Opening <sup>③</sup>
TFM215B0AH0	300-1400	21½ inch	7½ x 21½ x 21	22	18⅞ x 18⅞
TFM235B0AH0	300-1700	23½ inch	7½ x 23½ x 21	24	20⅞ x 18⅞
TFM260B0AH0	400-2100	26 inch	7½ x 26 x 21	25	23⅞ x 18⅞

**Table IAQ-2-B – Furnace Perfect Fit™ High Efficiency Air Cleaner With Five (5) Inch Expandable Media Filter**

Model Number	Airflow Range	Perfect Fit™ Furnace Width	Uncrated Dimensions(in.) H x W x D	Shipping Weight	Return Air Opening <sup>③</sup>
TFM145B0FR0	300-1200	14½ inch <sup>①</sup>	7½ x 14½ x 27	18	11⅞ x 24 <sup>13</sup> / <sub>16</sub>
TFM175B0FR0	300-1500	17½ inch <sup>①</sup>	7½ x 17½ x 27	21	14⅞ x 24 <sup>13</sup> / <sub>16</sub>
TFM210B0FR0	300-2000	21 inch <sup>②</sup>	7½ x 21 x 27	24	18⅞ x 24 <sup>13</sup> / <sub>16</sub>
TFM245B0FR0	400-2000	24½ inch <sup>②</sup>	7½ x 24½ x 27	27	21⅞ x 24 <sup>13</sup> / <sub>16</sub>

- ① Side return no transition required.  
 ② Side return transition required.  
 ③ Actual opening does not include flange.

## Perfect Fit™ Filter Accessories

**Table IAQ-3-A — Furnace Cartridge Media**

Model Number	Description	Qty	Enclosure Used with	Shipping Weight
BAYFTFREXM2	Expandable 5" Cartridge Media Filter	2 / Box	14 1/2 - 24 1/2 x 21	5

**Table IAQ-3-B — Air Handler Cartridge Media**

Model Number	Description	Qty	Enclosure Used with	Shipping Weight
BAYFTAHEXM2	Expandable 5" Cartridge Media Filter	2 / Box	21 1/2-26 x 27	5

**Table IAQ-3-C — Furnace Frames**

Model Number	Description	Qty	Enclosure Used with	Shipping Weight
BAYFRAME145①	Expandable Media Filter	1 / Box	14 1/2	5
BAYFRAME175①	Expandable Media Filter	1 / Box	17 1/2	5
BAYFRAME210①	Expandable Media Filter	1 / Box	21	5
BAYFRAME245①	Expandable Media Filter	1 / Box	24 1/2	5

**Table IAQ-3-D — Air Handler Frames**

Model Number	Description	Qty	Enclosure Used with	Shipping Weight
BAYFRAME215①	Expandable Media Frame	1 / Box	21	5
BAYFRAME235①	Expandable Media Frame	1 / Box	23 1/2	5
BAYFRAME260①	Expandable Media Frame	1 / Box	26	5

① Includes one filter.

# AccuClean™ Dimensions

Table IAQ-4-A — Air Handler Filters

iFD Filter	AIR HANDLER MODEL NUMBER	
	A	B
AFD215	21½	19
AFD235	23½	21
AFD260	26	23½

## OUTLINE DRAWING AIR HANDLER MODELS

21" CABINET DEPTH ONLY  
ADD DOOR DEPTH FOR TOTAL

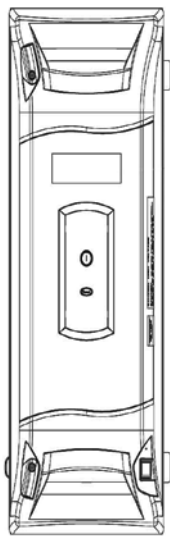
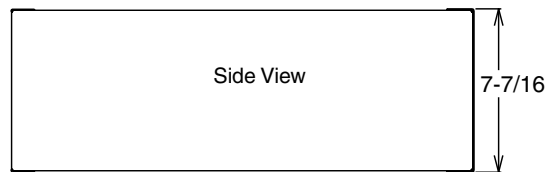
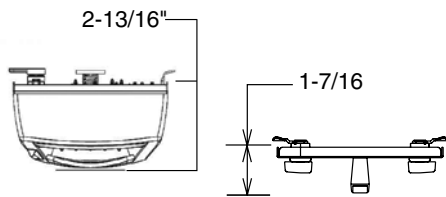

AccuClean™

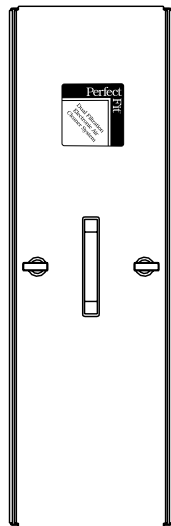

5" MEDIA

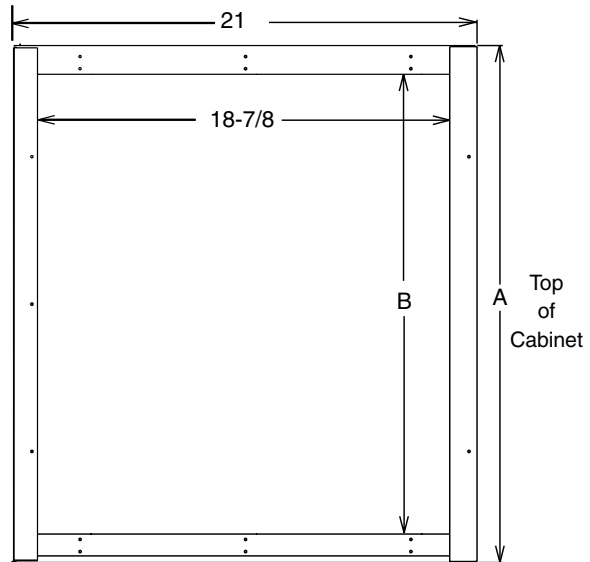

Indoor Air Quality

# AccuClean™ Dimensions

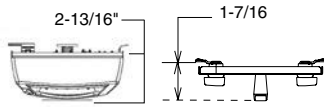

**Table IAQ-5-A — Upflow Furnace Filters**

FURNACE MODEL NUMBER		
ifD Filter	A	B
AFD145	14½	12
AFD175	17½	15
AFD210	21	18½
AFD245	24½	22

**Table IAQ-5-B — Downflow Furnace Filters**

FURNACE MODEL NUMBER		
ifD Filter	A	B
AFD14D	14½	11⅞
AFD17D	17½	14⅞
AFD21D	21	18⅞
AFD24D	24½	21⅞

**OUTLINE DRAWING  
DOWNFLOW FURNACE MODELS**

21" CABINET DEPTH ONLY  
ADD DOOR DEPTH FOR TOTAL

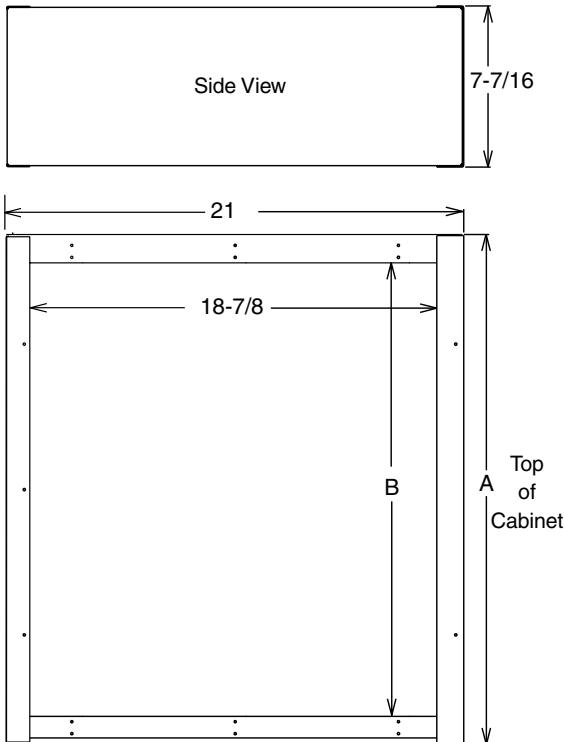

**OUTLINE DRAWING UPFLOW FURNACE MODELS**

27" CABINET DEPTH ONLY  
ADD DOOR DEPTH FOR TOTAL

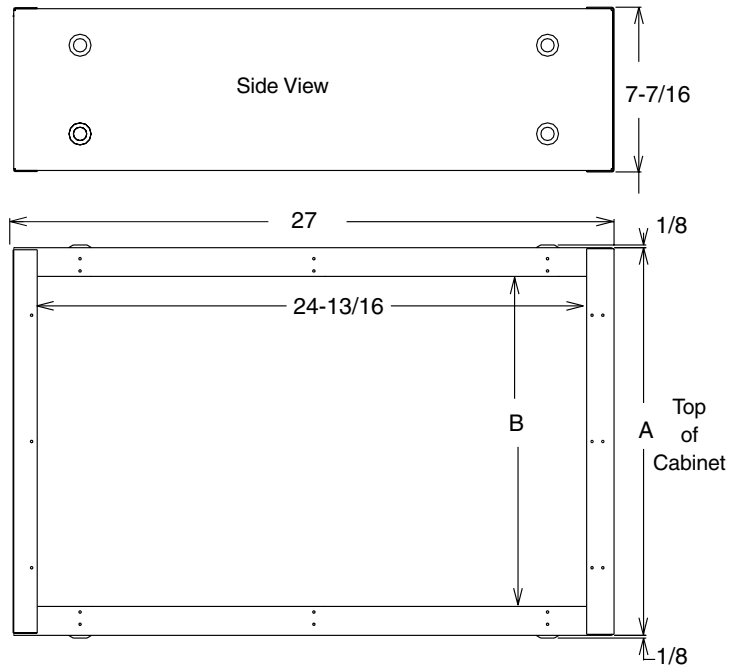

Indoor Air Quality

# Humidifiers Fan Powered and Bypass

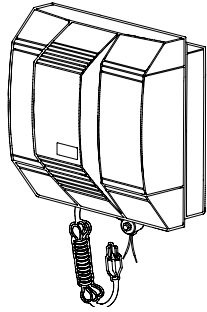

**AHUMD500A**

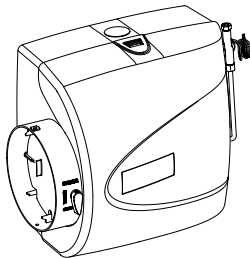

**AHUMD200A, 300A**

## AHUMD500A

- Flow Through Fan Powered Humidifier
- High Performance Humidifier Delivers up to 18 Gallons per Day
- Automatic Humidifier Control with O.D. Sensor for up to 50% more Humidity
- Front Cover Access for easy replacement of humidifier pad
- Aluminum Humidifier Pad Treated with Ceramic Coating for Enhanced Pad Performance
- Reliable Brass Solenoid Valve w/Stainless Steel Valve Seat
- UV Resistant Cabinet and Scale Control Insert
- Saddle Valve
- Polyslate Gray Housing matches Furnace Cabinet Color
- Decorative nameplate
- 120V Power Line Cord
- 110V Primary/24A Transformer

## AHUMD200, 300A

- AHUMD300A Bypass delivers up to 17 Gallons per day
- AHUMD200A delivers up to 12 Gallons per day
- AHUMD300A Automatic Humidifier Control and O.D. Sensor for up to 50% more Humidity
- AHUMD200A Manual Humidifier Control
- UV Resistant Cabinet and Scale Control Insert
- Front Cover Access for easy replacement of humidifier pad
- Aluminum Humidifier Pad Treated with Ceramic Coating for Enhanced Pad Performance
- Reliable Brass Solenoid Valve w/Stainless Steel Valve Seat
- Field Convertible Duct Connection, Left or Right Side
- Built in Summer / Winter Damper
- Saddle Valve
- Polyslate Gray Housing matches Furnace Cabinet Color
- Decorative nameplate
- 110V Primary/24V Secondary, 10VA Transformer

**Table IAQ-6-A — Specifications: Humidifier with Humidistat**

Model Number	Description	Used With	Mfg. Plant	Shipping Weight
AHUMD500APA00C <sup>①④</sup>	Fan Powered Humidifier	All Furnace Models	TY	20
AHUMD300ABA00B <sup>②</sup>	Large Bypass Humidifier	All Furnace Models	TY	15
AHUMD200ABM00B <sup>③</sup>	Small Bypass Humidifier	All Furnace Models	TY	14

- ① Includes Automatic Humidifier Control (Duct Mount Only).  
 ② Includes Automatic Humidifier Control (Duct Mount Only) and 120/24V transformer.  
 ③ Includes Manual Humidifier Control and 120/24V transformer.  
 ④ Not applicable for horizontal installations.

**Table IAQ-6-B — Accessories**

Model Number	Description	Used With	Mfg. Plant	Shipping Weight
BAYPAD02A1310A	Large Humidifier Pad 13"x10"	AHUMD500,300A	TY	1
BAYPAD01A1010A	Small Humidifier Pad 9-7/8"x9-5/8"	AHUMD200A	TY	1
ACONTH01AAUTOA	Automatic Humidifier Control	AHUMD200A	TY	1
BAYRLY10ASENSA	Current Sensing Relay	All	TY	1
BAYPLT01AMHCOA	Adapter Plate (Duct Mount)	Manual Humidifier Control	TY	1



# Humidifiers

## Fan Powered and Bypass

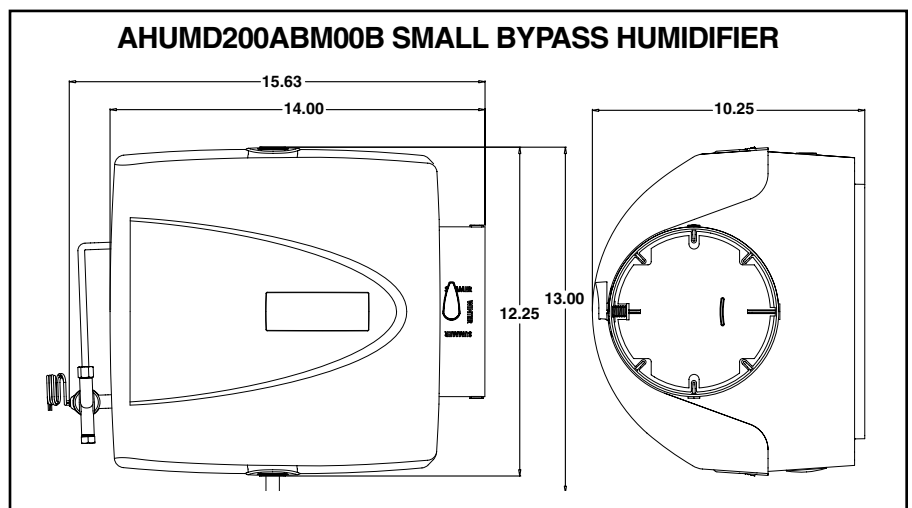
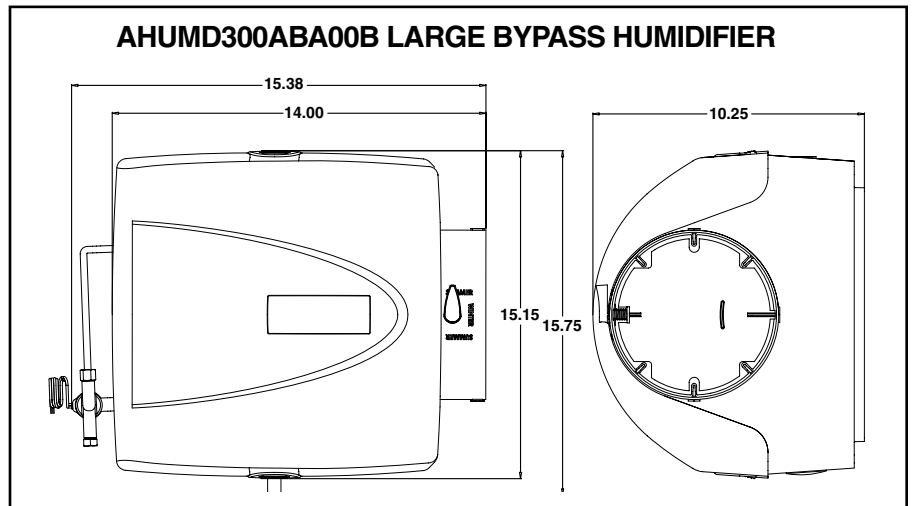
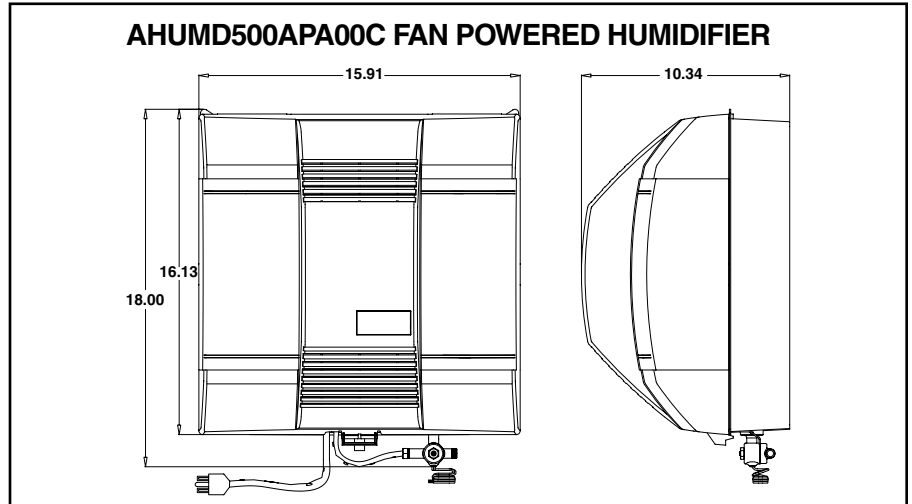

# Humidifiers Fan Powered and Bypass

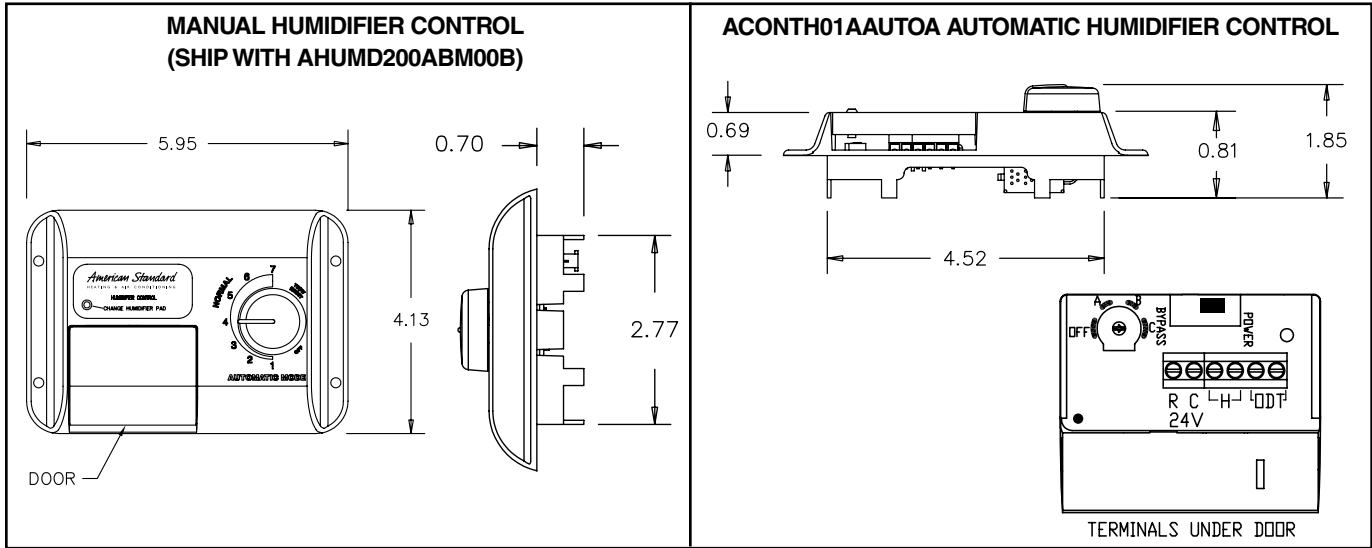

## SUGGESTED BYPASS HUMIDIFIER LOCATIONS

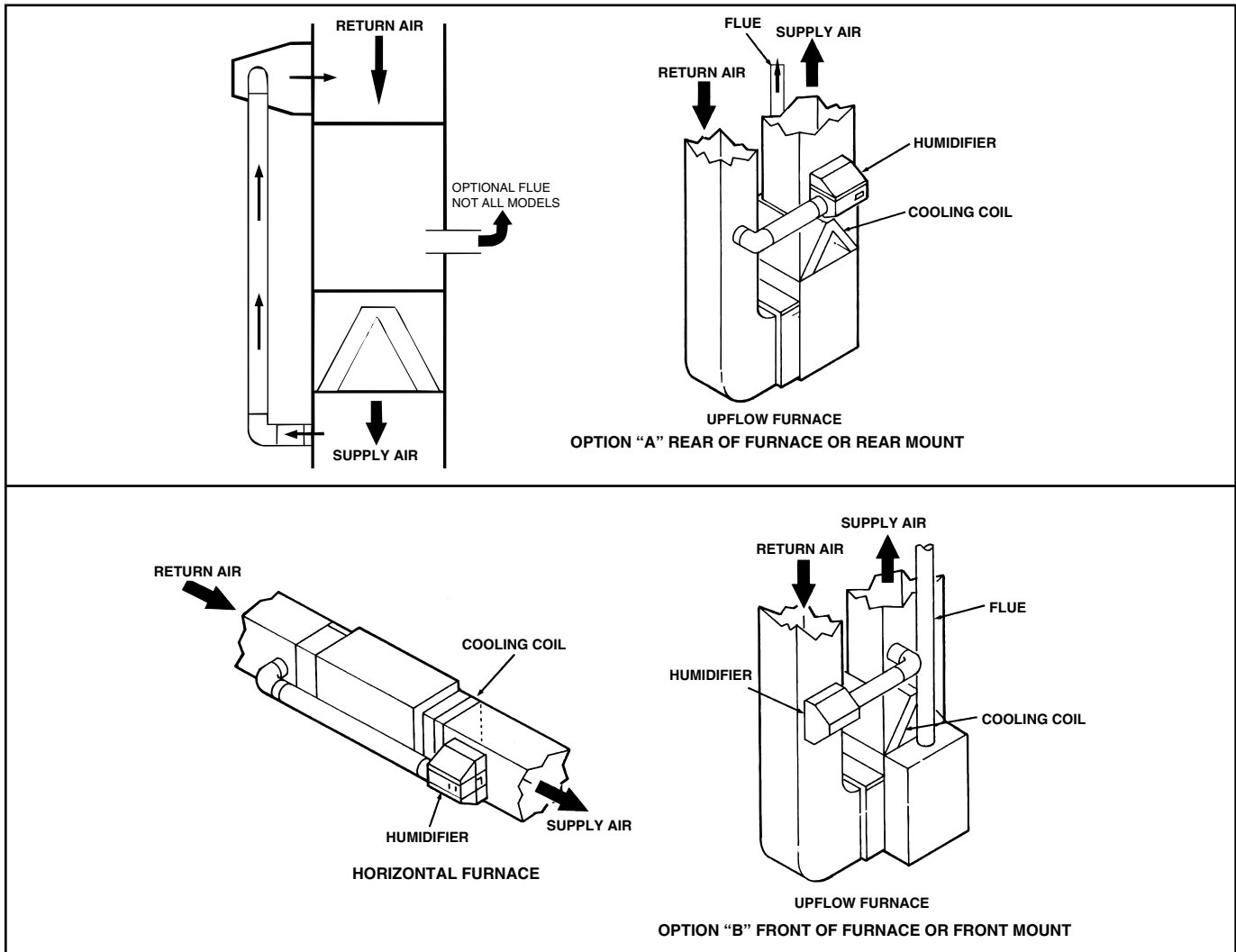

Indoor Air Quality

For complete equipment / combination selections, installation instructions and warranty information, please refer to Product Data/Ratings and/or Installers Guides and Limited Warranty Handbooks.

# Energy Recovery Ventilator (ERV)

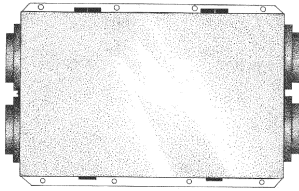

- American Standard ERV technology for all seasons and climates
- Static plate energy transfer core for efficient transfer of heat and moisture
- Passive defrost - condensate drain not required
- Balancing dampers not required
- Multi position mounting
- Percent Timer (PT) control included with ERV for simple, automatic operation
- Optional Push Button (PB) control connects to PT control
- Cam action door latches for quick service access
- Heavy gauge, powder painted steel cabinet
- Permanently lubricated motor bearings (ball bearings)
- 6" and 8" double collar duct connections for AERVR100 and 200
- 8" round compatible duct connection for AERVR300
- Closed cell foam gasketing for insulation integrity
- 1" duct board insulation with cleanable foil face
- May be installed in conditioned and unconditioned spaces
- Cabinet / Door color: American Standard Polyslate Gray / Tarpaulin Gray
- **Based Limited Warranty 5-years**
- **Registered Limited Warranty 10-years**
- **Optional extended warranty**

**Table IAQ-9-A — Specifications: ERV**

Model Number	Nominal Airflow (CFM)	Power Supply	Uncrated Dimensions (In.) H x W x D	Shipping Weight
AERVR100A9P00A <sup>①</sup>	130	120/1/60	20 <sup>1</sup> / <sub>8</sub> x 28 <sup>3</sup> / <sub>4</sub> x 13	65
AERVR200A9P00A <sup>①</sup>	200	120/1/60	20 <sup>1</sup> / <sub>8</sub> x 28 <sup>3</sup> / <sub>4</sub> x 23 <sup>7</sup> / <sub>8</sub>	85
AERVR300A9P00A <sup>①</sup>	300	120/1/60	20 <sup>1</sup> / <sub>8</sub> x 28 <sup>3</sup> / <sub>4</sub> x 23 <sup>7</sup> / <sub>8</sub>	95

<sup>①</sup> Percent Timer Control included with the ERV.

**Table IAQ-9-B — Specifications: ERV**

Model Number	Sensible Recovery Effectiveness(32°F)	Latent Recovery (32°F)	Total Recovery (95°F)
AERVR100A9P00A	72% @ 124 cfm	55% @ 124 cfm	46% @ 126 cfm
AERVR200A9P00A	78% @ 181 cfm	62% @ 181 cfm	52% @ 180 cfm
AERVR300A9P00A	70% @ 295 cfm	51% @ 295 cfm	43% @ 295 cfm

**Table IAQ-9-C — Optional Accessories**

Model Number	Description	Used With	Shipping Weight
ACONTV10APBC0A	Point of Use Push Button Control	ERV models 100, 200, 300	1
BAYFLT10A1010A	Filters - 2 per pack	ERV models 100	1
BAYFLT20A1020A	Filters - 2 per pack	ERV models 200, 300	1
BAYWHT10AVENTA <sup>②</sup>	6 inch White Vinyl Ventilation Hood	ERV models 100, 200	1
BAYBRN10AVENTA <sup>②</sup>	6 inch Brown Vinyl Ventilation Hood	ERV models 100, 200	1
BAYGLV10AVENTA <sup>②</sup>	8 inch Galvanized Ventilation Hood	ERV models 300	2

<sup>②</sup> Qty 1.

## Conventional 24 Volt Connected Controls

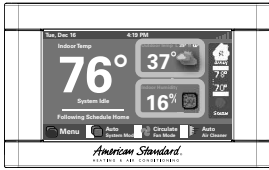

**GOLD 824  
ACONT824AS52DA**



### ACONT824AS52DA

- NEXIA™ Z-Wave Bridge Inside
- Connect over 200 Z-Wave devices
- WiFi (802.11 b/g/n) or Ethernet connection
- Control from a smartphone, tablet, or computer <sup>1,2</sup>
- 4.3" diagonal HD color touchscreen
- Compatible with non-communicating conventional 24 Volt systems
- Cooling, heating, heat pump, and dual fuel
- 7 Day programmable with up to six schedules per day
- Five day weather forecast, weather radar, and weather alerts <sup>1</sup>
- Indoor relative humidity display
- Enhanced dehumidification
- 2 Auxiliary dry contacts
- Control 2 of the following: Whole house humidifier, dehumidifier, or ventilation system
- Test modes and alert diagnostics
- Nexia Diagnostics
- Upgradeable software
- Silver/Gray color
- Limited Warranty: 5 yr. base/10 yr. registered

### Application:

HVAC system compatibility:

- Conventional gas/electric, heat pump, and dual fuel systems
- Conventional boiler systems (forced air only)
- Conventional HVAC systems:
  - 2 Heat / 2 cool
- Heat Pump systems: Up to 5 stages heat / 2 stages cool (2 compressor heat - 3 auxiliary heat / 2 cooling)
- Heat Pump switchover valve: Selectable "with cool or with heat"
- Remote Indoor Sensor (optional): ZZSENSAL0400AA
- Remote Outdoor Sensor (optional): BAYSEN01ATEMPA
- PWM Circuit (BK terminal): controls indoor unit variable speed blowers
- Wall Cover Plate BAYCOVR800A

### Dimensions:

- Product: 5.43"w x 3.39"h x 1.30"d
- Display: 4.15"w x 2.65"h

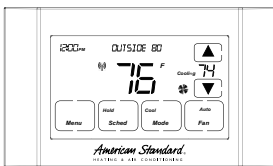

**SILVER 624  
ACONT624AS42DA**



### ACONT624AS42DA

- NEXIA™ Home Intelligence compatible
- Z-wave comfort control
- Control from a smartphone, tablet, or computer <sup>1,2,3</sup>
- 4.3" diagonal black and white touchscreen
- Compatible with conventional 24 volt HVAC, heat pump, dual fuel, and conventional boiler systems (baseboard and radiator)
- 7 Day programmable with up to 4 schedules per day
- Humidity sensor and RH display
- Remote temperature sensor connections (1 indoor/1 outdoor)
- Auxiliary & compressor heat lockouts
- Auxiliary dry contact
- Enhanced dehumidification (cooling)
- Adjustable variable speed fan settings (PWM)
- Energy Savings Mode (ESM)
- Screen lock and guest lock
- Service test modes
- Upgradeable software
- Silver/Gray color
- Limited Warranty: 1 yr. base/5 yr. registered

### Application:

HVAC system compatibility:

- Up to 4 Stages Heat/2 Stages Cool
- Conventional gas/electric, heat pump, and dual fuel systems
- Conventional boiler systems (baseboard & radiators)
- Remote Indoor Sensor (optional): ZZSENSAL0400AA
- Remote Outdoor Sensor (optional): BAYSEN01ATEMPA
- Wall Cover Plate BAYCOVR800A
- Use with Nexia Bridge for Nexia™ Home Intelligence compatibility<sup>1,2</sup>

### Dimensions:

- Product: 5.9"w x 3.47"h x .95"d
- Display: 3.8"w x 2.3"h

<sup>1</sup> Requires high speed router, internet service, and connection to Nexia™ Home Intelligence.

<sup>2</sup> Nexia Remote Climate Access is included with the purchase of a Connected Control. Adding accessories to your Nexia system requires a monthly subscription for remote access via most web-enabled smartphone and computers.

<sup>3</sup> Requires Nexia Bridge

## AccuLink™ Communicating Connected Controls



**PLATINUM 950  
AZONE950AC52ZA**

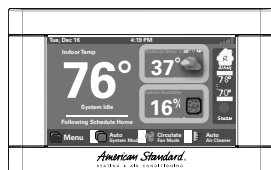

**PLATINUM 850  
ACONT850AC52UA**



### AZONE950AC52ZA

- NEXIA™ Home Intelligence compatible
- WiFi (802.11 b/g/n)
- Control from a smartphone, tablet, or computer <sup>1,2,3</sup>
- 7" diagonal HD color touchscreen
- Compatible with AccuLink™ II communicating systems (variable speed and two stage)
- Compatible with conventional 24 Volt HVAC, heating, heat pump, and dual fuel systems when used with accessory relay panel model BAY24VRPAC52DB
- 7 Day programmable with up to 6 schedules per day
- Five day weather forecast, weather radar, and weather alerts <sup>1</sup>
- Indoor relative humidity display
- Control up to 3 accessory devices with relay panel model BAY24VRPAC52DB
- Whole house humidifier, dehumidifier, or ventilation system
- Test modes and diagnostic screens
- Nexia Diagnostics
- Upgradeable software
- Silver/Gray color
- Limited Warranty: 5 yr. base/10 yr. registered

### ACONT850AC52UA

- NEXIA™ Z-Wave Bridge Inside
- Connect over 200 Z-Wave devices
- WiFi (802.11 b/g/n) or Ethernet connection
- Control from a smartphone, tablet, or computer <sup>1,2</sup>
- 4.3" diagonal HD color touchscreen
- Compatible with AccuLink™ II communicating systems (variable speed and two stage)
- Compatible with conventional 24 Volt HVAC, heating, heat pump, and dual fuel systems when used with accessory relay panel model BAY24VRPAC52DB
- 7 Day programmable with up to six schedules per day
- Five day weather forecast, weather radar, and weather alerts <sup>1</sup>
- Indoor relative humidity display
- Test modes and alert diagnostics
- Nexia Diagnostics
- Upgradeable software
- Silver/Gray color
- Wall Cover Plate BAYCOVR800A
- Limited Warranty: 5 yr. base/10 yr. registered

### Application:

HVAC system compatibility:

- AccuLink™ II communicating systems (variable speed and two stage)
- Conventional gas/electric, heat pump, dual fuel systems, or boiler systems (forced air only) with use of relay panel model BAY24VRPAC52DB. Relay panel controls up to 5 stages heat, 2 stages cool, remote indoor and outdoor connections, humidifier, dehumidifier, and ventilation system.

### Dimensions:

- Product: 7.3"w x 4.3"h x 1.2"d
- Display: 6.1"w x 3.6"h

### Application:

HVAC system compatibility:

- AccuLink™ II communicating systems (variable speed and two stage)
- Conventional gas/electric, heat pump, dual fuel systems, or boiler systems (forced air only) with use of relay panel model BAY24VRPAC52DB. Relay panel controls up to 5 stages heat, 2 stages cool, remote indoor and outdoor connections, humidifier, dehumidifier, and ventilation system.

### Dimensions:

- Product: 5.43"w x 3.39"h x 1.30"d
- Display: 4.15"w x 2.65"h

<sup>1</sup> Requires high speed router, internet service, and connection to Nexia™ Home Intelligence.

<sup>2</sup> Nexia Remote Climate Access is included with the purchase of a Connected Control. Adding accessories to your Nexia system requires a monthly subscription for remote access via most web-enabled smartphone and computers.

<sup>3</sup> Requires Nexia Bridge

## AccuLink™ Communicating Connected Controls

---

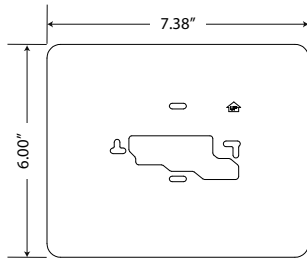

**BAYCOVR800A**

### **BAYCOVR800A**

#### **Application:**

- Use with  
ACONT624AS42DA,  
ACONT824AS52DA,  
ACONT850AC52UA

#### **Dimensions:**

- 7.38" w x 6.00" h
- Finish: Silver

## Zoning AccuLink™ Platinum 950 Control



**AZONE950AC52ZA**

### Features:

- Controls Communicating or conventional 24V HVAC systems (5 heat/2 cool/Dual Fuel) with 24V Relay Panel Accessory
- 7" High Definition Color LCD Display
- Compatible with AccuLink™ Zoning Systems - software version 2.0 or later required
- Optional faceplate colors (black, white, graphite)
- System Modes - Heat/Cool/Auto
- Fan Modes - On/Auto/Circulate
- Easy to use Touch Screen Interface
- 7 Day Programmable - (manual or guided scheduling options)
- 1-Touch Pre-Sets for Home, Away, Sleep Settings
- Customizable Home Screen (Color, Information, Layout)
- 5 Day Weather Forecast, Local Radar Image & Weather Alerts (via Wireless Home Network)
- Weekly & Monthly System Run Time Monitor
- Allergy Clean & Quick Clean Indoor Air Cycles
- Built in Dual Fuel Economic Calculator.
- Digital Photo Album with Slide Show Screen Saver Option
- Embedded Diagnostics - (Alerts have time/date stamp with on screen probable causes)
- Heating Humidification Control
  - Relative Humidity Control
  - Dew Point Control
- Cooling Dehumidification Control
- Ventilation Control
- Whole-house Dehumidifier Control
- Smart Continuous Fan (disables Cont. Fan if RH is above setpoint)
- Adjustable Continuous Fan Airflow Settings (35 to 100%)
- Service Reminders - Filters, EAC, Humidifier, HVAC System, UV Lights
- Upgradeable Firmware
- Remote Access Option (for controlling the 950 Control only) is included with purchase. Remote access provided by Nexia™ Home Intelligence
- Keypad lock - Pin Code Option Security Options
- Dealer and System Information Screens
- Remote Indoor Sensor (optional): ZZSENSAL0400AA
- Remote Outdoor Sensor (optional): BAYSEN01ATEMPA
- Fahrenheit or Celsius Indoor Display Options
- 802.11 B/G - WLAN (wireless local area network) for weather feed

### Dimensions:

- 7.3" width X 4.3" height X 1.2" depth

### Storage Temperature:

- 40°F to 175°F, 5% to 95% RH non-condensing

### Operating Temperature:

- 25°F to 126°F, 5% to 90% RH non-condensing

### Optional front bezels for Platinum 950

#### Control:

**Graphite** - AZGRA950ABEZEL

**White** - AZWHT950ABEZEL

**Black** - AZBLK950ABEZEL



**NEXIA**<sup>™</sup>  
HOME INTELLIGENCE

## Zoning Communicating Sensor with Display

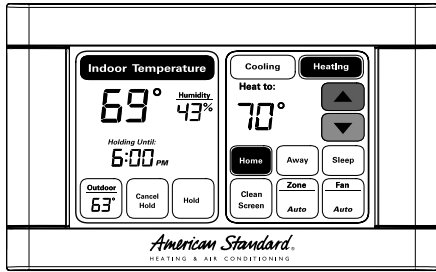

**AZONE940AC52ZA**

- Compatible with AccuLink™ Zoning Systems
- 3-Wire Communicating Zone Sensor
- 4.5" backlit touch screen black and white display
- Optional faceplate colors (silver/black, black, white, graphite)
- Zone Mode - Heat/Cool/Auto
- Fan Mode - Auto/On
- Synchronizes with AZONE950 Real Time Clock
- Weekly Comfort Settings scheduled from AZONE950
- Zone Schedule Override
  - Permanent Hold
  - Temporary Override
- 1-Touch Pre-Sets For Home, Away, Sleep Settings
- 24V power
- Displays Zone Temperature & Relative Humidity
- Displays Outdoor Temperature & Outdoor Relative Humidity (if available on AZONE950)
- Clean Screen Function
- Keypad lock- enabled from AZONE950
- Fahrenheit or Celsius - enabled from AZONE950 (system level setting)

### Dimensions:

- 5.5" width x 3.4" height x 1.1" depth

### Storage Temperature:

- -40°F to 170°F, 0% - 95% RH

### Operating Temperature:

- 32°F - 120°F, 5% - 90% RH non-condensing

### Optional front bezels for AZONE940

#### Control:

- AZGRA940ABEZEL - Graphite
- AZWHT940ABEZEL - White
- AZBLK940ABEZEL - Black



## Conventional 24 Volt HVAC System Interface Relay Panel for AccuLink™ Platinum 950 Control

---

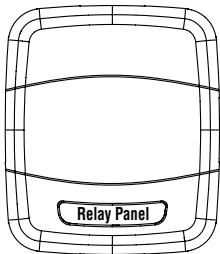

**BAY24VRPAC52DB**

### **BAY24VRPAC52DB — With AUX**

#### **Contact Control**

- 5 Heat (Gas, Oil, Electric)/2 Cool/Heat Pump/Dual Fuel
- Optional remote indoor temperature connection point
- Optional outdoor temperature connection point
- LED stage indicators
- Removable low voltage terminal blocks for easy service and replacement
- Humidifier Control

#### **AUX Contacts-Whole-home**

- Dehumidifier Control
- Ventilation Control

#### **Dimensions:**

- 8.0" width x 9.3" height x 1.9" depth

#### **Storage Temperature:**

- -40° to 175°F, 5% - 95% RH non-condensing

#### **Operating Temperature:**

- -40° to 150°F, 5% - 95% RH non-condensing

**NOTE:** For applications with a variable speed outdoor unit and a non-communicating variable speed furnace, use **BAY24VRPAC52DC** (available 2016).

## Communicating System

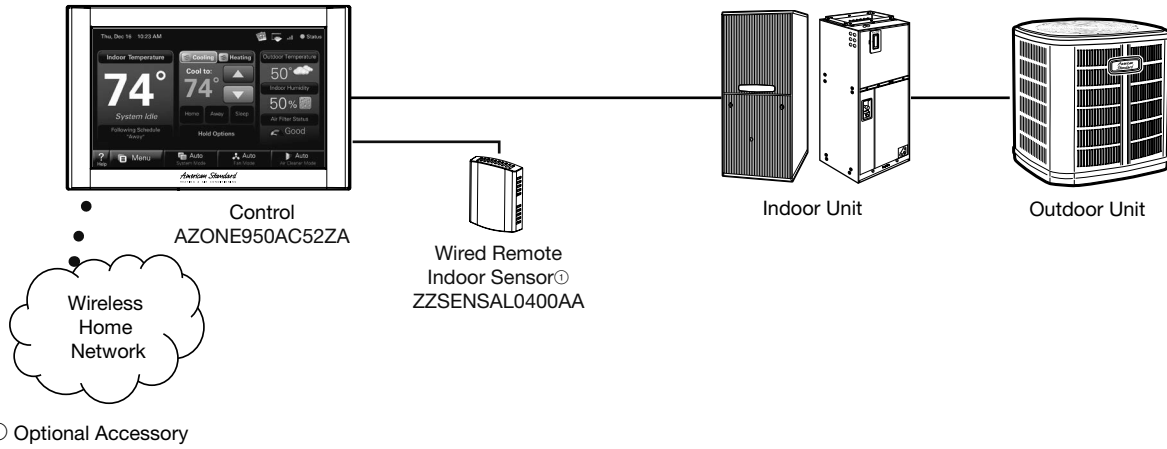

## 24V System

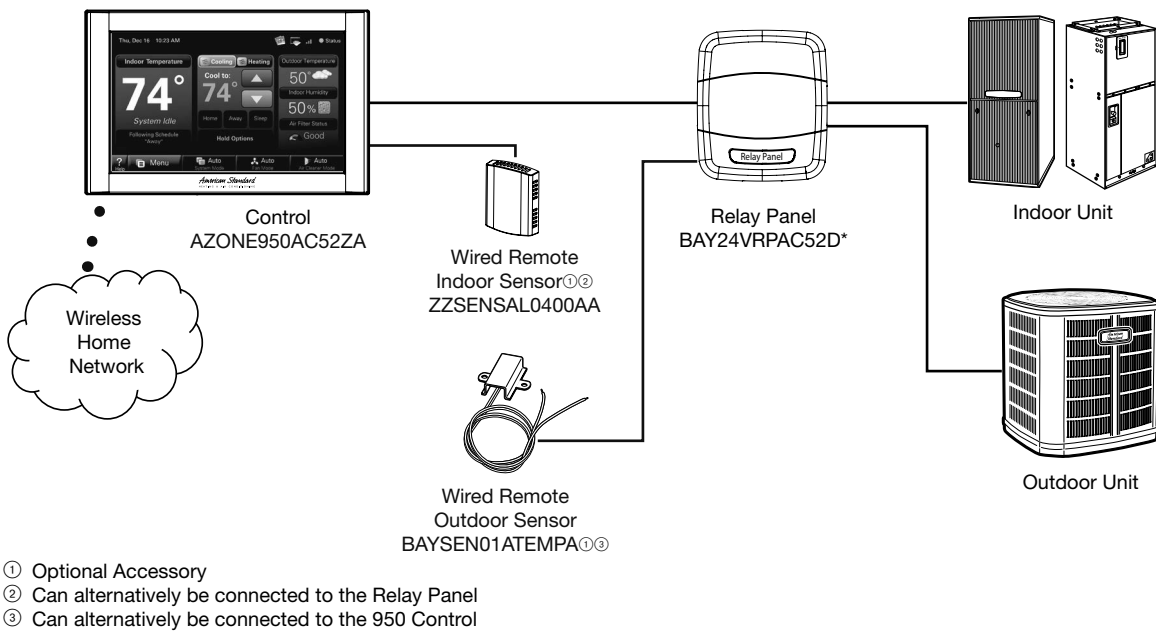

## AccuLink™ Zoning Assembly

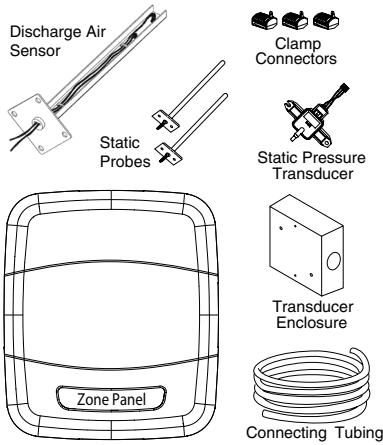

**ZZONEPNLAC52ZB**

### ZZONEPNLAC52ZB American Standard Variable Speed Indoor Unit (Air handler/Gas Furnace) required.

**Includes:**

- Four Zone Communicating Zone Panel with discharge air sensor, static pressure transducer and housing, supply, return air static probes and connecting tubing, and three wiring blocks
- Automatically sets maximum CFM per zone
- Compatible with 24 Volt systems with the addition of 24 Volt relay panel
- Controls 24 Volt power open, power close modulating dampers

- Auto detects installed dampers
- Supports 2-wire (ZZSENSAL0400AA) and 3-wire (AZONE940) zone sensors
- Adjustable damper motor travel times of 15 to 60 seconds
- Requires field supplied 24 volt power supply
- Up to four 1.5 VA dampers can be wired in parallel to each zone
- Backlit LCD display for easy setup and service
- Optional return and mixed air sensors are available
- Removable low voltage terminal blocks for easy service and replacement

## AccuLink™ Zone Expander Panel (Required with more than 4 zones)

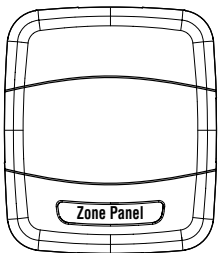

**ZZONEEXPAC52ZB**

### ZZONEEXPAC52ZA\*

- Expands the maximum number of zones per system to eight
- Controls 24 Volt power open, power close modulating dampers
- Auto detects installed dampers
- Supports 2-wire (ZZSENSAL0400AA) and 3-wire (AZONE940) zone sensors
- Adjustable damper motor travel times of 15 to 60 seconds
- Requires field supplied 24 Volt power supply

**Dimensions:**

- 8.0" width x 9.3" height x 1.9" depth

**Storage Temperature:**

- -40° to 175°F, 5% to 95% RH non-condensing

**Operating Temperature:**

- -40° to 150°F, 5% to 95% RH non-condensing

\*This is the same Zone Panel that ships as part of the Zoning Assembly

# AccuLink™ Zoning Component Overview

## Zoned Communicating System

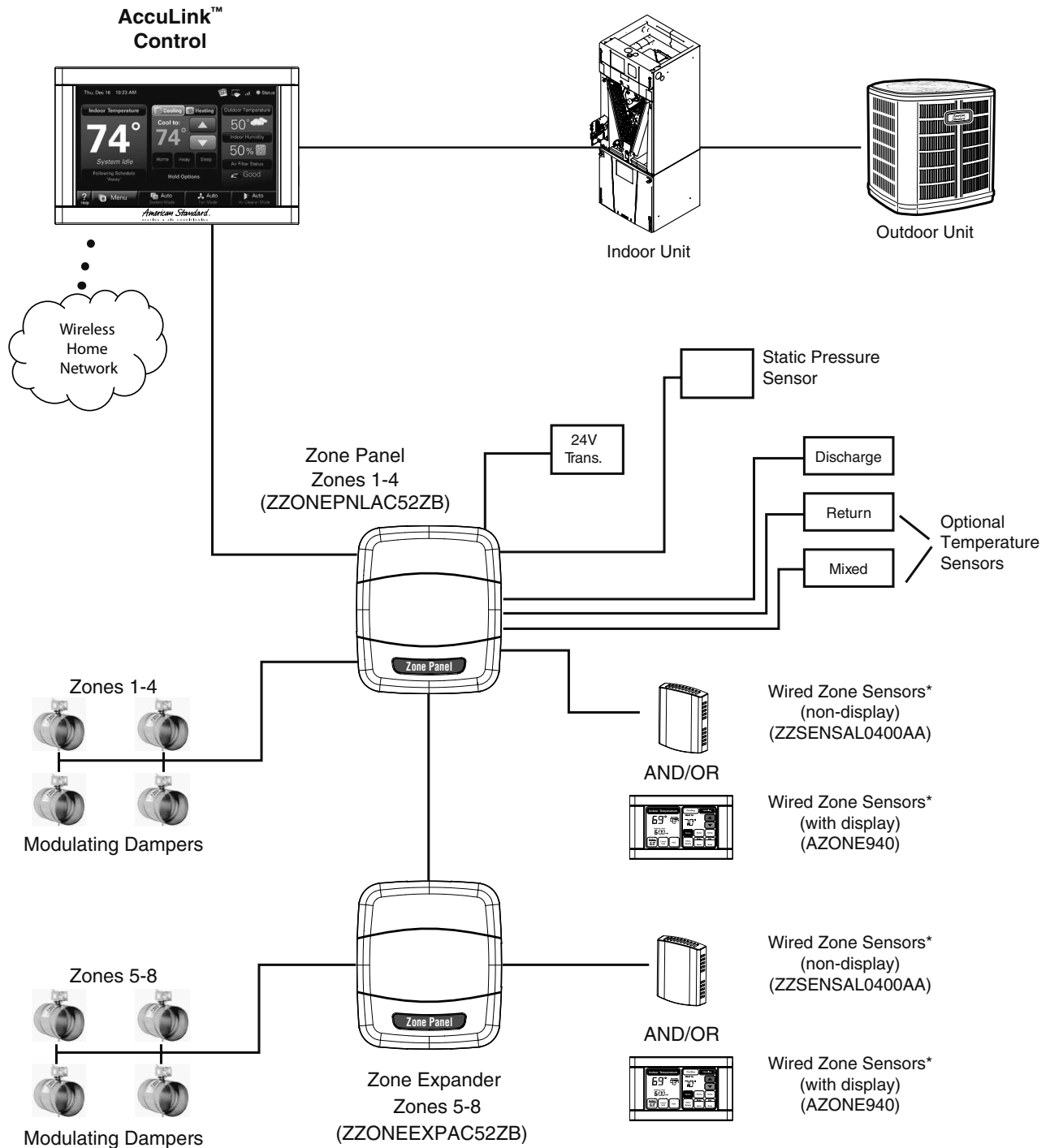

\* Up to 4 AZONE940 Zone Sensors with display may be used with each ZZONEPNLAC52ZA Zone Panel. AZONE940 Zone Sensors may be used in all zones or in combination with zones using non-display ZZSENSAL0400AA sensors.

# AccuLink™ Zoning Component Overview (Cont.)

## Zoned 24V

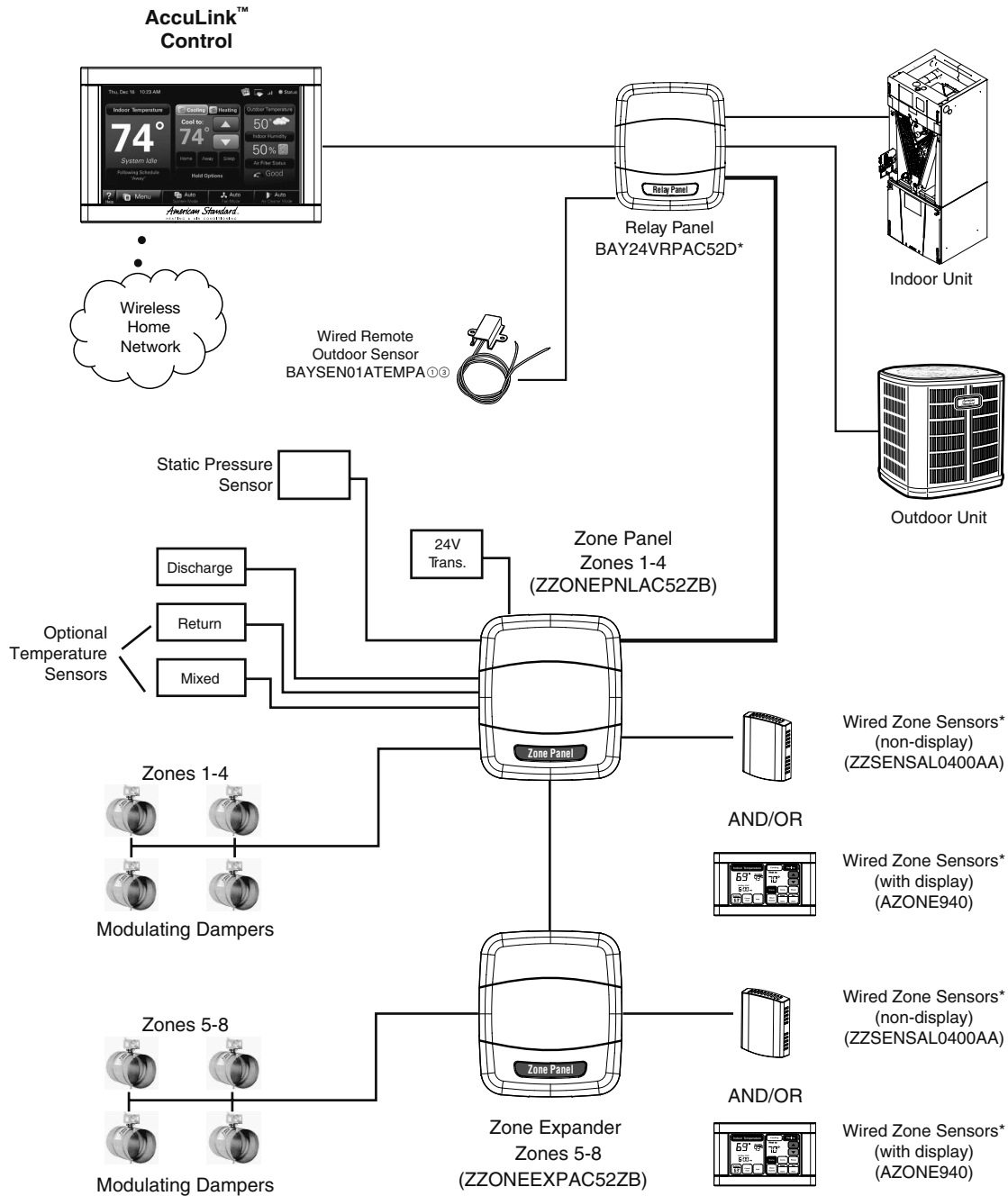

\* Up to 4 AZONE940 Zone Sensors with display may be used with each ZZONEPNLAC52ZA Zone Panel. AZONE940 Zone Sensors may be used in all zones or in combination with zones using non-display ZZSENSAL0400AA sensors.

- ① Optional Accessory
- ② Can alternatively be connected to the Relay Panel
- ③ Can alternatively be connected to the 950 Control

## 24 Volt Modulating Dampers

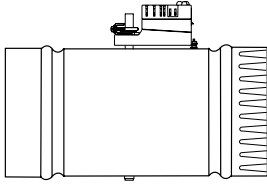

**Round Dampers**

### Round Dampers

- 24 VAC Powered open/Powered closed
- Three wire connection - 18 gauge
- 1.5 VA damper actuator with 60 second travel time
- 18 in. lbs. of torque
- Manual gear release
- Screw terminal blocks
- Flexible shutoff seal provides 98% closure

**Table CCZS-11-A — Specifications: Round Dampers**

Model Number	Power Supply	Description	Fits Round Duct Size
ZDAMPRDMA0004A	24 VAC	Round	4"
ZDAMPRDMA0006A	24 VAC	Round	6"
ZDAMPRDMA0007A	24 VAC	Round	7"
ZDAMPRDMA0008A	24 VAC	Round	8"
ZDAMPRDMA0009A	24 VAC	Round	9"
ZDAMPRDMA0010A	24 VAC	Round	10"
ZDAMPRDMA0012A	24 VAC	Round	12"
ZDAMPRDMA0014A	24 VAC	Round	14"
ZDAMPRDMA0016A	24 VAC	Round	16"
ZDAMPRDMA0018A	24 VAC	Round	18"
ZDAMPRDMA0020A	24 VAC	Round	20"

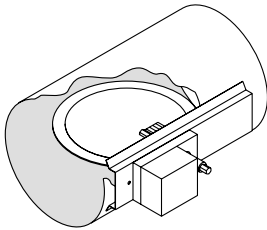

**Retro-Fit Round Dampers**

### Retro-Fit Round Dampers

- 24 VAC Powered open/Powered closed
- Three wire connection - 18 gauge
- Slip-In-Design installs quickly
- 1.5 VA damper actuator with 60 second travel time
- 18 in. lbs. of torque
- Manual gear release
- Screw terminal blocks
- Flexible shutoff seal provides 98% closure

**Table CCZS-11-B — Specifications: Retrofit Round Dampers**

Model Number	Power Supply	Description	Fits Round Duct Size
ZDAMPRRMA0004A	24 VAC	Retrofit Round	4"
ZDAMPRRMA0005A	24 VAC	Retrofit Round	5"
ZDAMPRRMA0006A	24 VAC	Retrofit Round	6"
ZDAMPRRMA0007A	24 VAC	Retrofit Round	7"
ZDAMPRRMA0008A	24 VAC	Retrofit Round	8"
ZDAMPRRMA0009A	24 VAC	Retrofit Round	9"
ZDAMPRRMA0010A	24 VAC	Retrofit Round	10"

## 24 Volt Modulating Dampers - Side Mount

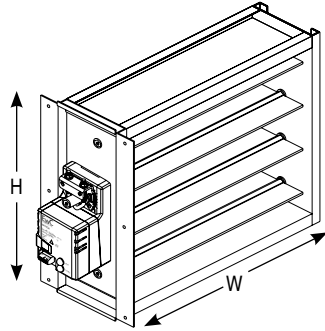

### Rectangular Dampers with Side Mount Actuator

- 24 VAC Powered open/Powered closed
- Three wire connection - 18 gauge
- 1.5 VA damper actuator with 60 second travel time
- 18 in. lbs. of torque
- Manual gear release
- Screw terminal blocks
- 97% leak proof rating
- Sturdy aluminum blades and frame
- Motor is always located on the second dimension of the model number, i.e ZDAMP\*MMA1012A will have the motor mounted on the 12" dimension

### Rectangular Dampers with Side Mount Actuator

**Table CCZS-12-A — Specifications: Rectangular Dampers with Side Mount Actuator**

Model Number	Power Supply	Description	Uncrated Dimensions (in.)	
			W	H
ZDAMPSMMA0806A	24 VAC	Rectangular-Side Mount Actuator	8	6
ZDAMPSMMA0808A	24 VAC	Rectangular-Side Mount Actuator	8	8
ZDAMPSMMA1006A	24 VAC	Rectangular-Side Mount Actuator	10	6
ZDAMPSMMA1008A	24 VAC	Rectangular-Side Mount Actuator	10	8
ZDAMPSMMA1010A	24 VAC	Rectangular-Side Mount Actuator	10	10
ZDAMPSMMA1206A	24 VAC	Rectangular-Side Mount Actuator	12	6
ZDAMPSMMA1208A	24 VAC	Rectangular-Side Mount Actuator	12	8
ZDAMPSMMA1210A	24 VAC	Rectangular-Side Mount Actuator	12	10
ZDAMPSMMA1212A	24 VAC	Rectangular-Side Mount Actuator	12	12
ZDAMPSMMA1406A	24 VAC	Rectangular-Side Mount Actuator	14	6
ZDAMPSMMA1408A	24 VAC	Rectangular-Side Mount Actuator	14	8
ZDAMPSMMA1410A	24 VAC	Rectangular-Side Mount Actuator	14	10
ZDAMPSMMA1412A	24 VAC	Rectangular-Side Mount Actuator	14	12
ZDAMPSMMA1414A	24 VAC	Rectangular-Side Mount Actuator	14	14
ZDAMPSMMA1606A	24 VAC	Rectangular-Side Mount Actuator	16	6
ZDAMPSMMA1608A	24 VAC	Rectangular-Side Mount Actuator	16	8
ZDAMPSMMA1610A	24 VAC	Rectangular-Side Mount Actuator	16	10
ZDAMPSMMA1612A	24 VAC	Rectangular-Side Mount Actuator	16	12
ZDAMPSMMA1614A	24 VAC	Rectangular-Side Mount Actuator	16	14
ZDAMPSMMA1616A	24 VAC	Rectangular-Side Mount Actuator	16	16
ZDAMPSMMA1806A	24 VAC	Rectangular-Side Mount Actuator	18	6
ZDAMPSMMA1808A	24 VAC	Rectangular-Side Mount Actuator	18	8
ZDAMPSMMA1810A	24 VAC	Rectangular-Side Mount Actuator	18	10
ZDAMPSMMA1812A	24 VAC	Rectangular-Side Mount Actuator	18	12
ZDAMPSMMA1814A	24 VAC	Rectangular-Side Mount Actuator	18	14
ZDAMPSMMA1816A	24 VAC	Rectangular-Side Mount Actuator	18	16
ZDAMPSMMA1818A	24 VAC	Rectangular-Side Mount Actuator	18	18
ZDAMPSMMA2006A	24 VAC	Rectangular-Side Mount Actuator	20	6
ZDAMPSMMA2008A	24 VAC	Rectangular-Side Mount Actuator	20	8
ZDAMPSMMA2010A	24 VAC	Rectangular-Side Mount Actuator	20	10
ZDAMPSMMA2012A	24 VAC	Rectangular-Side Mount Actuator	20	12
ZDAMPSMMA2014A	24 VAC	Rectangular-Side Mount Actuator	20	14
ZDAMPSMMA2016A	24 VAC	Rectangular-Side Mount Actuator	20	16
ZDAMPSMMA2018A	24 VAC	Rectangular-Side Mount Actuator	20	18
ZDAMPSMMA2020A	24 VAC	Rectangular-Side Mount Actuator	20	20

## 24 Volt Modulating Dampers - Side Mount

**Table CCZS-13-A — Specifications: Rectangular Dampers with Side Mount Actuator (continued)**

Model Number	Power Supply	Description	Uncrated Dimensions (in.)	
			W	H
ZDAMPSMMA2206A	24 VAC	Rectangular-Side Mount Actuator	22	6
ZDAMPSMMA2208A	24 VAC	Rectangular-Side Mount Actuator	22	8
ZDAMPSMMA2210A	24 VAC	Rectangular-Side Mount Actuator	22	10
ZDAMPSMMA2212A	24 VAC	Rectangular-Side Mount Actuator	22	12
ZDAMPSMMA2214A	24 VAC	Rectangular-Side Mount Actuator	22	14
ZDAMPSMMA2216A	24 VAC	Rectangular-Side Mount Actuator	22	16
ZDAMPSMMA2218A	24 VAC	Rectangular-Side Mount Actuator	22	18
ZDAMPSMMA2220A	24 VAC	Rectangular-Side Mount Actuator	22	20
ZDAMPSMMA2222A	24 VAC	Rectangular-Side Mount Actuator	22	22
ZDAMPSMMA2406A	24 VAC	Rectangular-Side Mount Actuator	24	6
ZDAMPSMMA2408A	24 VAC	Rectangular-Side Mount Actuator	24	8
ZDAMPSMMA2410A	24 VAC	Rectangular-Side Mount Actuator	24	10
ZDAMPSMMA2412A	24 VAC	Rectangular-Side Mount Actuator	24	12
ZDAMPSMMA2414A	24 VAC	Rectangular-Side Mount Actuator	24	14
ZDAMPSMMA2416A	24 VAC	Rectangular-Side Mount Actuator	24	16
ZDAMPSMMA2418A	24 VAC	Rectangular-Side Mount Actuator	24	18
ZDAMPSMMA2420A	24 VAC	Rectangular-Side Mount Actuator	24	20
ZDAMPSMMA2422A	24 VAC	Rectangular-Side Mount Actuator	24	22
ZDAMPSMMA2424A	24 VAC	Rectangular-Side Mount Actuator	24	24
ZDAMPSMMA2606A	24 VAC	Rectangular-Side Mount Actuator	26	6
ZDAMPSMMA2608A	24 VAC	Rectangular-Side Mount Actuator	26	8
ZDAMPSMMA2610A	24 VAC	Rectangular-Side Mount Actuator	26	10
ZDAMPSMMA2612A	24 VAC	Rectangular-Side Mount Actuator	26	12
ZDAMPSMMA2614A	24 VAC	Rectangular-Side Mount Actuator	26	14
ZDAMPSMMA2616A	24 VAC	Rectangular-Side Mount Actuator	26	16
ZDAMPSMMA2618A	24 VAC	Rectangular-Side Mount Actuator	26	18
ZDAMPSMMA2620A	24 VAC	Rectangular-Side Mount Actuator	26	20
ZDAMPSMMA2622A	24 VAC	Rectangular-Side Mount Actuator	26	22
ZDAMPSMMA2624A	24 VAC	Rectangular-Side Mount Actuator	26	24
ZDAMPSMMA2626A	24 VAC	Rectangular-Side Mount Actuator	26	26
ZDAMPSMMA2806A	24 VAC	Rectangular-Side Mount Actuator	28	6
ZDAMPSMMA2808A	24 VAC	Rectangular-Side Mount Actuator	28	8
ZDAMPSMMA2810A	24 VAC	Rectangular-Side Mount Actuator	28	10
ZDAMPSMMA2812A	24 VAC	Rectangular-Side Mount Actuator	28	12
ZDAMPSMMA2814A	24 VAC	Rectangular-Side Mount Actuator	28	14
ZDAMPSMMA2816A	24 VAC	Rectangular-Side Mount Actuator	28	16
ZDAMPSMMA2818A	24 VAC	Rectangular-Side Mount Actuator	28	18
ZDAMPSMMA2820A	24 VAC	Rectangular-Side Mount Actuator	28	20
ZDAMPSMMA2822A	24 VAC	Rectangular-Side Mount Actuator	28	22
ZDAMPSMMA2824A	24 VAC	Rectangular-Side Mount Actuator	28	24
ZDAMPSMMA2826A	24 VAC	Rectangular-Side Mount Actuator	28	26
ZDAMPSMMA2828A	24 VAC	Rectangular-Side Mount Actuator	28	28
ZDAMPSMMA3006A	24 VAC	Rectangular-Side Mount Actuator	28	6
ZDAMPSMMA3008A	24 VAC	Rectangular-Side Mount Actuator	28	8
ZDAMPSMMA3010A	24 VAC	Rectangular-Side Mount Actuator	28	10
ZDAMPSMMA3012A	24 VAC	Rectangular-Side Mount Actuator	28	12
ZDAMPSMMA3014A	24 VAC	Rectangular-Side Mount Actuator	28	14
ZDAMPSMMA3016A	24 VAC	Rectangular-Side Mount Actuator	28	16
ZDAMPSMMA3018A	24 VAC	Rectangular-Side Mount Actuator	28	18
ZDAMPSMMA3020A	24 VAC	Rectangular-Side Mount Actuator	28	20
ZDAMPSMMA3022A	24 VAC	Rectangular-Side Mount Actuator	28	22
ZDAMPSMMA3024A	24 VAC	Rectangular-Side Mount Actuator	28	24
ZDAMPSMMA3026A	24 VAC	Rectangular-Side Mount Actuator	28	26
ZDAMPSMMA3028A	24 VAC	Rectangular-Side Mount Actuator	28	28
ZDAMPSMMA3030A	24 VAC	Rectangular-Side Mount Actuator	28	30



# 24 Volt Modulating Dampers - Bottom Mount

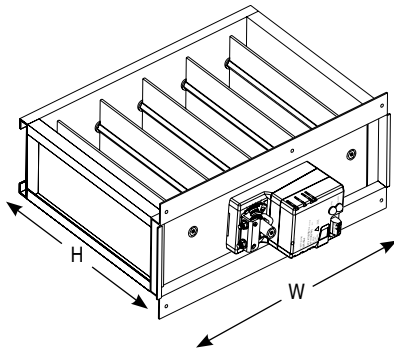

**Rectangular Dampers with Bottom Mount Actuator**

## Rectangular Dampers with Bottom Mount Actuator

- 24 VAC Powered open/Powered closed
- Three wire connection - 18 gauge
- 1.5 VA damper actuator with 60 second travel time
- 18 in. lbs. of torque
- Manual gear release
- Screw terminal blocks
- 97% leak proof rating
- Sturdy aluminum blades and frame
- Motor is always located on the second dimension of the model number, i.e ZDAMP\*MMA1012A will have the motor mounted on the 12" dimension

**Table CCZS-14-A — Specifications: Rectangular Dampers with Bottom Mount Actuator**

Model Number	Power Supply	Description	Uncrated Dimensions (in.)	
			H	W
ZDAMPBMMMA0810A	24 VAC	Rectangular-Bottom Mount Actuator	8	10
ZDAMPBMMMA0812A	24 VAC	Rectangular-Bottom Mount Actuator	8	12
ZDAMPBMMMA0814A	24 VAC	Rectangular-Bottom Mount Actuator	8	14
ZDAMPBMMMA0816A	24 VAC	Rectangular-Bottom Mount Actuator	8	16
ZDAMPBMMMA0818A	24 VAC	Rectangular-Bottom Mount Actuator	8	18
ZDAMPBMMMA0820A	24 VAC	Rectangular-Bottom Mount Actuator	8	20
ZDAMPBMMMA0822A	24 VAC	Rectangular-Bottom Mount Actuator	8	22
ZDAMPBMMMA0824A	24 VAC	Rectangular-Bottom Mount Actuator	8	24
ZDAMPBMMMA0826A	24 VAC	Rectangular-Bottom Mount Actuator	8	26
ZDAMPBMMMA0828A	24 VAC	Rectangular-Bottom Mount Actuator	8	28
ZDAMPBMMMA0830A	24 VAC	Rectangular-Bottom Mount Actuator	8	30
ZDAMPBMMMA1012A	24 VAC	Rectangular-Bottom Mount Actuator	10	12
ZDAMPBMMMA1014A	24 VAC	Rectangular-Bottom Mount Actuator	10	14
ZDAMPBMMMA1016A	24 VAC	Rectangular-Bottom Mount Actuator	10	16
ZDAMPBMMMA1018A	24 VAC	Rectangular-Bottom Mount Actuator	10	18
ZDAMPBMMMA1020A	24 VAC	Rectangular-Bottom Mount Actuator	10	20
ZDAMPBMMMA1022A	24 VAC	Rectangular-Bottom Mount Actuator	10	22
ZDAMPBMMMA1024A	24 VAC	Rectangular-Bottom Mount Actuator	10	24
ZDAMPBMMMA1026A	24 VAC	Rectangular-Bottom Mount Actuator	10	26
ZDAMPBMMMA1028A	24 VAC	Rectangular-Bottom Mount Actuator	10	28
ZDAMPBMMMA1030A	24 VAC	Rectangular-Bottom Mount Actuator	10	30
ZDAMPBMMMA1214A	24 VAC	Rectangular-Bottom Mount Actuator	12	14
ZDAMPBMMMA1216A	24 VAC	Rectangular-Bottom Mount Actuator	12	16
ZDAMPBMMMA1218A	24 VAC	Rectangular-Bottom Mount Actuator	12	18
ZDAMPBMMMA1220A	24 VAC	Rectangular-Bottom Mount Actuator	12	20
ZDAMPBMMMA1222A	24 VAC	Rectangular-Bottom Mount Actuator	12	22
ZDAMPBMMMA1224A	24 VAC	Rectangular-Bottom Mount Actuator	12	24
ZDAMPBMMMA1226A	24 VAC	Rectangular-Bottom Mount Actuator	12	26
ZDAMPBMMMA1228A	24 VAC	Rectangular-Bottom Mount Actuator	12	28
ZDAMPBMMMA1230A	24 VAC	Rectangular-Bottom Mount Actuator	12	30
ZDAMPBMMMA1416A	24 VAC	Rectangular-Bottom Mount Actuator	14	16
ZDAMPBMMMA1418A	24 VAC	Rectangular-Bottom Mount Actuator	14	18
ZDAMPBMMMA1420A	24 VAC	Rectangular-Bottom Mount Actuator	14	20
ZDAMPBMMMA1422A	24 VAC	Rectangular-Bottom Mount Actuator	14	22
ZDAMPBMMMA1424A	24 VAC	Rectangular-Bottom Mount Actuator	14	24
ZDAMPBMMMA1426A	24 VAC	Rectangular-Bottom Mount Actuator	14	26
ZDAMPBMMMA1428A	24 VAC	Rectangular-Bottom Mount Actuator	14	28
ZDAMPBMMMA1430A	24 VAC	Rectangular-Bottom Mount Actuator	14	30
ZDAMPBMMMA1618A	24 VAC	Rectangular-Bottom Mount Actuator	16	18
ZDAMPBMMMA1620A	24 VAC	Rectangular-Bottom Mount Actuator	16	20
ZDAMPBMMMA1622A	24 VAC	Rectangular-Bottom Mount Actuator	16	22
ZDAMPBMMMA1624A	24 VAC	Rectangular-Bottom Mount Actuator	16	24
ZDAMPBMMMA1626A	24 VAC	Rectangular-Bottom Mount Actuator	16	26
ZDAMPBMMMA1628A	24 VAC	Rectangular-Bottom Mount Actuator	16	28
ZDAMPBMMMA1630A	24 VAC	Rectangular-Bottom Mount Actuator	16	30
ZDAMPBMMMA1820A	24 VAC	Rectangular-Bottom Mount Actuator	18	20
ZDAMPBMMMA1822A	24 VAC	Rectangular-Bottom Mount Actuator	18	22
ZDAMPBMMMA1824A	24 VAC	Rectangular-Bottom Mount Actuator	18	24
ZDAMPBMMMA1826A	24 VAC	Rectangular-Bottom Mount Actuator	18	26
ZDAMPBMMMA2022A	24 VAC	Rectangular-Bottom Mount Actuator	20	22
ZDAMPBMMMA2024A	24 VAC	Rectangular-Bottom Mount Actuator	20	24

## 24 Volt Modulating Dampers

Table CCZS-15-A — Rectangular Damper Net Free Area

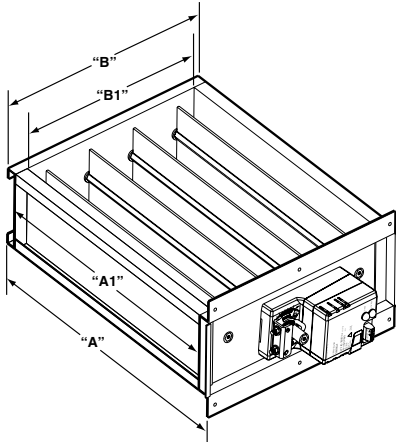

Listed Size	Actual Outside Size	Actual Inside Size	8	10	12	14	16	18	20	22	24	26	28	30	Listed Size	High
			7.813	9.813	11.813	13.813	15.813	17.813	19.813	21.813	23.813	25.813	27.813	29.813	Act. Outside Size B	
Wide	A	A1	5.813	7.813	9.813	11.813	13.813	15.813	17.813	19.813	21.813	23.813	25.813	27.813	Act. Inside Size B1	
			3	3	4	5	6	7	7	8	9	10	11	11	No. of Blades	
6	5.812	4.313	19.5	28.1	34.9	41.6	48.6	55.1	63.8	70.5	77.3	84.0	90.8	99.4		
8	7.812	6.313	28.5	41.1	51.0	60.9	70.8	80.7	93.3	103.2	113.1	123.0	132.9	145.5		
10	9.812	8.313	37.5	54.2	67.2	80.2	93.2	106.3	122.9	135.9	148.9	162.0	175.0	191.6		
12	11.812	10.313	46.5	67.2	83.3	99.5	115.7	131.8	152.5	168.6	184.8	200.9	217.1	237.7		
14	13.812	12.313	55.6	80.2	99.5	118.8	138.1	157.4	182.0	201.3	220.6	239.9	259.2	283.8		
16	15.812	14.313	64.6	93.2	115.7	138.1	160.5	183.0	211.6	234.0	256.4	278.9	301.3	329.9		
18	17.812	16.313	73.6	106.3	131.8	157.4	183.0	208.5	241.1	266.7	292.3	317.8	343.4	376.0		
20	19.812	18.313	82.7	119.3	148.0	176.7	205.4	234.1	270.7	299.4	328.1	356.8	385.5	422.1		
22	21.812	20.313	91.7	132.3	164.2	196.0	227.8	259.6	300.3	332.1	363.9	395.8	427.6	468.2		
24	23.812	22.313	100.7	145.4	180.3	215.3	250.2	285.2	329.8	364.8	399.8	435.2	469.7	514.3		
26	25.812	24.313	109.8	158.4	196.5	234.6	272.7	310.8	359.4	397.5	435.6	473.7	511.8	560.4		
28	27.812	26.313	118.8	171.4	212.6	253.9	295.1	336.3	389.0	430.2	471.4	512.7	553.8	606.5		
30	29.812	28.313	127.8	184.4	228.8	273.2	317.5	361.9	418.5	462.9	507.3	551.6	596.0	652.6		

# Programmable 7 Day Comfort Controls

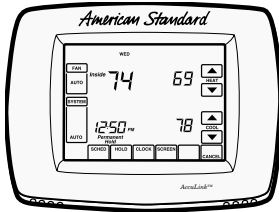

**ACONT900A**

**ACONT900AC43UA - AccuLink™**

- Communicating Programmable
- Interactive Touchscreen
- Continuous Comfort-R™
- Smart Continuous Fan
- Adjustable Continuous Fan, 25-100%
- Multiple Filter Reminders
- Humidity Sensor
- Dehumidification Control
- Window Frost Control
- Dual Fuel Compatible
- BAYCOVR600A - Wall cover plate
- Energy Saver

**Application:**

- 4 Heat/2 Cool (Gas, Oil or Electric)
- BAYTAM00AC00UA - Communicating Telephone Access module

**Dimensions:**

6.02" w x 4.62" h x 1.35" d  
Finish: Bright White

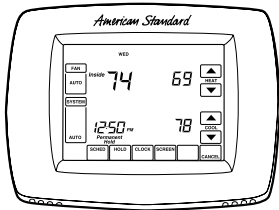

**ACONT800A**

**ACONT800AS11AA**

- Interactive Touchscreen
- Effortless Programming
- Large, Backlit Display
- Streamlined Design
- Armchair Programming
- Real Time Clock
- Visual Reminder Cues
- BAYCOVR600A - Wall cover plate
- Energy Saver

**Application:**

- 1 Heat/1 Cool (Gas, Oil or Electric)
- 1 Heat/0 Cool (Gas, Oil or Electric)
- 0 Heat/1 Cool
- ZZSENSAL0800AA - Remote Indoor Temperature Sensor

**Dimensions:**

6.02" w x 4.62" h x 1.35" d  
Finish: Bright White

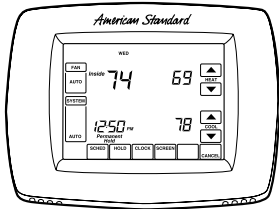

**ACONT802A**

**ACONT802AS32DA**

- Interactive Touchscreen
- Effortless Programming
- Large, Backlit Display
- Streamlined Design
- Armchair Programming
- Real Time Clock
- Visual Reminder Cues
- BAYCOVR600A - Wall cover plate
- Energy Saver

**Application:**

- Up to 3 Heat/2 Cool (Gas, Oil or Electric)/HP
- ZZSENSAL0800AA - Remote Indoor Temperature Sensor

**Dimensions:**

6.02" w x 4.62" h x 1.35" d  
Finish: Bright White

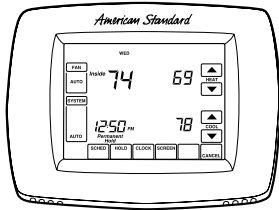

**ACONT803A**

**ACONT803AS32DA**

- Built-in Humidity Sensor
- Dehumidification Control
- Interactive Touchscreen
- Effortless Programming
- Large, Backlit Display
- Streamlined Design
- Armchair Programming
- Real Time Clock
- Visual Reminder Cues
- BAYCOVR600A - Wall cover plate
- Energy Saver

**Application:**

- Up to 3 Heat/2 Cool (Gas, Oil or Electric)/HP
- ZZSENSAL0800AA - Remote Indoor Temperature Sensor

**Dimensions:**

6.02" w x 4.62" h x 1.35" d  
Finish: Bright White

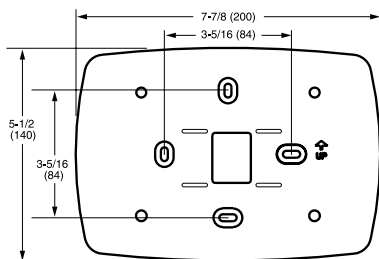

**BAYCOVR600A**

**BAYCOVR600A**

**Application:**

- Use with ACONT800/900A Series Comfort Controls

**Dimensions:**

7.87" w x 5.50" h  
Finish: Bright White

# Programmable 5/2 Day Comfort Controls

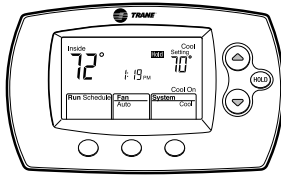

**ACONT600A**

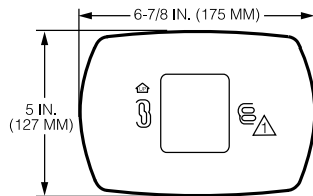

MEDIUM COVER PLATE

**BAYCOVR700A**

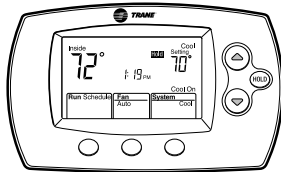

**ACONT602A**

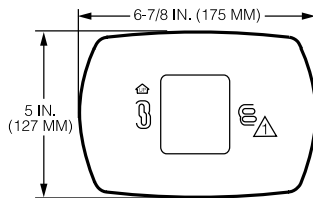

MEDIUM COVER PLATE

**BAYCOVR700A**

## ACONT600AF11MA

### 1 Heat/1 Cool

- 5/2 or 5/1/1 Programming
- Simple to Install and Use
- Front Wired (Wires attach to wall plates)
- Standard Wiring Terminal Block
- Easy to follow Sequential Programming
- Inside and set temperatures displayed simultaneously
- No auxiliary heat capability
- Plain language (no symbols)
- Easy battery access
- Easy to understand soft key controls
- BAYCOVR700A - Wall cover plate
- 6.87" w x 5.0" h
- Finish: Bright White

## ACONT602AF22MA

### 2 Heat/2 Cool

- 5/2 or 5/1/1 Programming
- Simple to Install and Use
- Front Wired (Wires attach to wall plates)
- Standard Wiring Terminal Block
- Easy to follow Sequential Programming
- Inside and set temperatures displayed simultaneously
- Plain language (no symbols)
- Easy battery access
- Easy to understand soft key controls
- BAYCOVR700A - Wall cover plate
- 6.87" w x 5.0" h
- Finish: Bright White

### Application:

- 1 stage heat pump, 0 stage Aux Heat
- 1 stage cool, 1 stage heat (Gas, electric, or oil)
- 1 stage cool, 0 stage heat
- 0 stage cool, 1 stage heat (Gas, electric, or oil)

### Dimensions:

- 5.81" w x 3.56" h x 1.50" d
- Finish: Bright White

### Application:

- 1 stage cool, 1 stage heat
- 2 stage cool, 1 stage heat
- 1 stage cool, 2 stage heat
- 2 stage cool, 2 stage heat
- 1 stage cool, 0 stage heat
- 0 stage cool, 1 stage heat (Gas, electric, or oil)
- 1 stage heat pump, 0 stage Aux Heat
- 1 stage heat pump, 1 stage Aux Heat

### Dimensions:

- 5.81" w x 3.56" h x 1.50" d
- Finish: Bright White

# Non-Programmable Comfort Controls

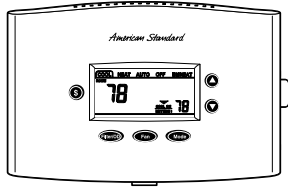

**ACONT402A**

**ACONT402AN32DA**

Auto Changeover  
Backlit Display & Keys  
Comfort Information Compar<sup>TM</sup>ment  
Energy Savings Mode  
Filter Reminder  
BAYSEN01ATEMPAA-Outdoor  
Temperature Sensor included\*  
Keypad Lock

**Application** (3-9 Wire Hookup -2  
for Outdoor Sensor) Heat Pump\*  
or A/C  
3 Heat/2 Cool  
No external Dual Fuel Kit Required  
Do not use with TAYPLUS103A  
ZZSENSAL0400AA - Remote Indoor  
Temperature Sensor

**Dimensions:**

6.75" w x 4.52" h x 1.20" d  
Finish: Bright White

- \* Requires external relay for oil furnace applications.
- \* Installation is required for outdoor temperature sensing and display

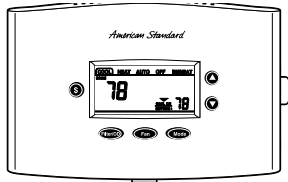

**ACONT401A**

**ACONT401AN21MA**

Auto Changeover  
Backlit Display & Keys  
Comfort Information Compar<sup>TM</sup>ment  
Energy Savings Mode  
Filter Reminder  
Outdoor Temperature Sensor  
Keypad Lock

**Application** (3-9 Wire Hookup -2  
for Outdoor Sensor) Heat Pump\*  
or A/C  
1 Stage Heat Pump\*\*, 1 Stage Aux Heat  
1 Stage Heat Pump\*\*, 0 Stage Aux Heat  
1 Stage Cool, 2 Stage Heat  
(Gas, Electric or Oil\*)  
1 Stage Cool, 1 Stage Heat  
(Gas, Electric or Oil\*)

1 Stage Cool, 0 Stage Heat  
0 Stage Cool, 2 Stage Heat  
(Gas, Electric or Oil\*)  
0 Stage Cool, 1 Stage Heat  
(Gas, Electric or Oil\*)

**Dimensions:**

6.75" w x 4.52" h x 1.20" d  
Finish: Bright White

- \* Requires external relay for oil furnace applications.
- \*\* **External TAYPLUS103A required for dual fuel applications.**  
BAYSEN01ATEMPA required for outdoor temperature sensing and display

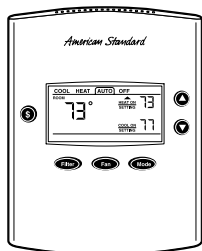

**ACONT200A**

**ACONT200AN11AA** ①

Auto Changeover  
Backlit Display & Keys  
Comfort Information Compar<sup>TM</sup>ment  
Energy Savings Mode  
Filter Reminder  
Key Pad Lock

**Application** (4 wire hookup - power  
stealing)\*  
1 Heat/1 Cool (Gas, Oil or electric)  
1 Heat/0 Cool (Gas, Oil or electric)  
0 Heat/1 Cool  
Finish: Bright White

**Dimensions:**

4.25" w x 5.33" h x 1.20" d

① Power Stealing 4 Wire - Resistor Terminal in Box. 4 - wire system to supply power with heating mode; both resistors must be installed for proper operation.

## Remote Sensors



### BAYSEN02ATEMPA

- Outdoor Temperature Sensor for use with ACONT800, 802, 803
- Accuracy +/- 1°F from -40 to 120°F

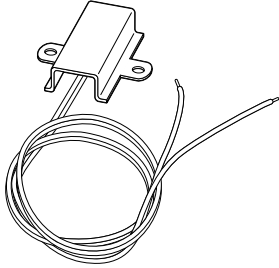

### BAYSEN01ATEMPA

- Outdoor Temperature Sensor for use with AZONE950AC, ACONT850AC, ACONT824AS, ACONT624AS, ACONT402AN, ACONT401AN, BAY24VRPAC52D\*.
- Accuracy
  - +/- 1.5°F over 32°F to 100°F
- Display Range
  - -40°F to 140°F

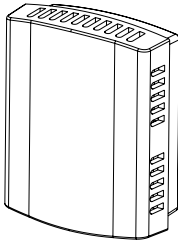

### ZZSENSAL0400AA

- Indoor Sensor for use with Remote Indoor Sensor for Use with AZONE950AC, ACONT850AC, ACONT824AS, ACONT624AS, ACONT402AN, ACONT401AN, BAY24VRPAC52D\*.
- Operating Ambient Temperature Range: 20° to 120°F (-6.7° to 48.9°C)
- Display Range: 20° to 120°F (-6.7° to 48.9°C)
- Sensor Accuracy: +/- .5°F at 75°F
- Operating Relative Humidity: 5% to 90% non-condensing

#### Dimensions in in. (mm):

- 1.54 (39)w x 1.93 (49)h x .625 (1.6)d
- Storage Temperature: -40° to 140°F (-40° to 60°C)
- Finish: White

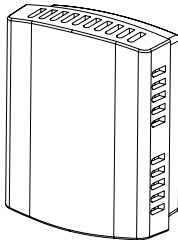

### ZZSENSAL0800AA

- Indoor Temperature Sensor for use with ACONT800, ACONT802, ACONT803
- Operating Ambient Temperature Range: 20° to 120°F (-6.7° to 48.9°C)
- Display Range: 0 to 99°F (-18 to 37°C)
- Sensor Accuracy: +/- 1.5°F at 70°F (+/- .84 at 21°C)
- Operating Relative Humidity: 5% to 95% non-condensing

#### Dimensions in in. (mm):

- 1.54 (39)w x 1.93 (49)h x .625 (1.6)d
- Storage Temperature: -40° to 140°F (-40° to 60°C)
- Finish: White

## Indoor Fan Delay Relay Kit

### BAY24X045

- For application to furnaces and air handlers with cooling coils equipped with capillary tube or 15% bleed expansion valve components.
- This kit allows the indoor fan to continue to run a short time after the

outdoor unit shuts off for increased cooling efficiency.

- The kit contains: 1 solid state time delay relay with four (4) color coded wires, 1 wiring diagram, 1 notice label, 1 mounting screw.

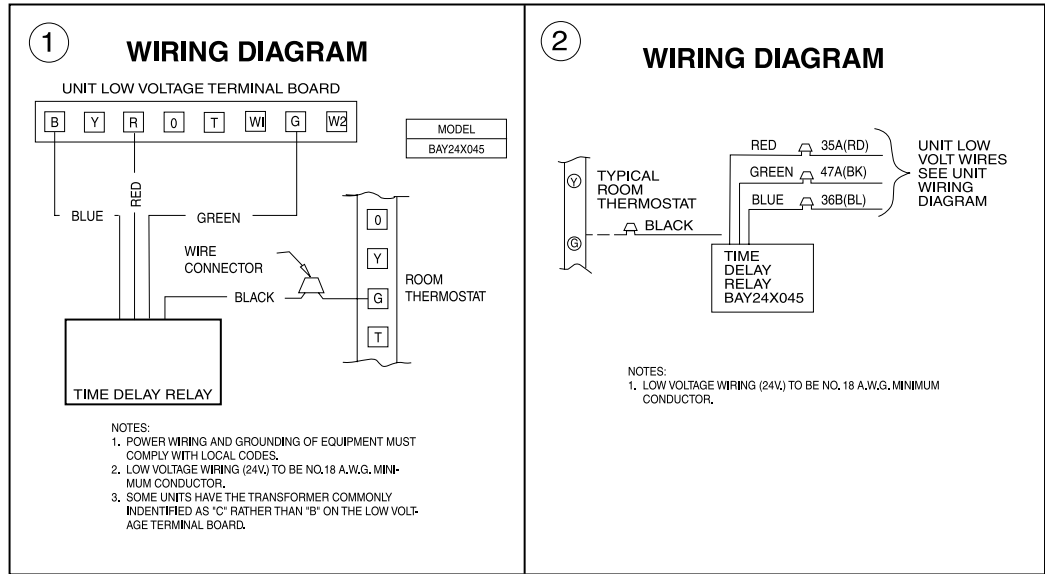

## Outdoor Thermostat Kit

### TAYSTAT250B

- The outdoor thermostat (ODT) is designed to turn "ON" the supplementary heater at a pre-selected outdoor temperature.
- The number and setting of the ODT is dependent on the heat loss of the structure and capacity of the heating

system installed.

- This model ODT gives a temperature range for 44°F. to -10°F. (See figure 1 for settings). The switching action is single pole/double throw, opening on temperature rise and closing on temperature fall, completing the circuit through the thermostat.

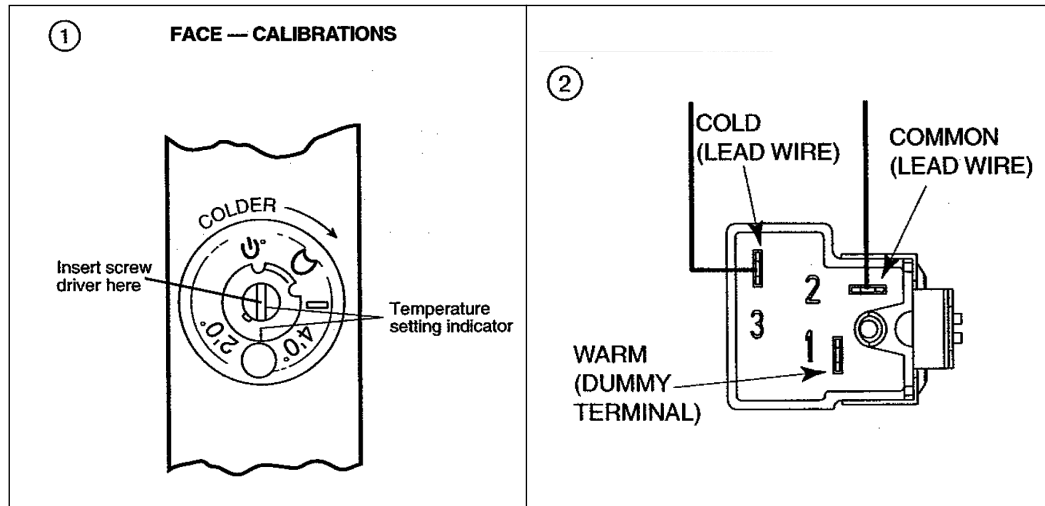

# Packaged Cooling Convertible 2-5 Tons

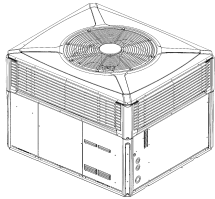

**4TCY5**

**Table PK-1-A — 4TCY5 - Gold 15 - Convertible Packaged Cooling - R-410A**

Model Number	Cooling Capacity (Btuh)	SEER/EER	Shipping Weight	MCA	Max Fuse	Sound Rating	Cabinet Dimensions (in.) H x D x W
<b>4TCY5 – 208-230/1/60</b>							
4TCY5024A1000A	-	15.00/12.00	-	-	-	-	36 x 43 x 51
4TCY5030A1000A	-	15.00/12.00	-	-	-	-	36 x 43 x 51
4TCY5036A1000A	-	15.00/12.00	-	-	-	-	38 x 43 x 51
4TCY5042A1000A	-	15.00/12.00	-	-	-	-	42 x 46 x 61
4TCY5048A1000A	-	15.00/12.00	-	-	-	-	42 x 46 x 61
4TCY5060A1000A	-	15.00/11.40	-	-	-	-	42 x 46 x 61

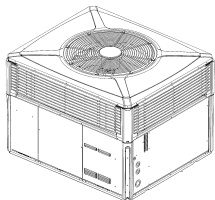

**4TCY4**

**Table PK-1-B — 4TCY4 - Gold 14 - Convertible Packaged Cooling - R-410A**

Model Number	Cooling Capacity (Btuh)	SEER/EER	Shipping Weight	MCA	Max Fuse	Sound Rating	Cabinet Dimensions (in.) H x D x W
<b>4TCY4 – 208-230/1/60</b>							
4TCY4024A1000B	23,400	14.00/12.00	444	16.5	25	68	36 x 43 x 51
4TCY4030A1000B	30,000	14.00/12.00	444	19.1	30	71	36 x 43 x 51
4TCY4036B1000B	38,000	14.20/12.00	450	24.6	40	69	38 x 43 x 51
4TCY4042B1000B	42,000	14.25/12.00	607	31.6	50	74	38 x 46 x 61
4TCY4048B1000B	50,000	14.20/12.00	607	35.4	50	72	38 x 46 x 61
4TCY4060A1000B	60,000	14.00/12.00	612	42.3	60	76	42 x 46 x 61
<b>4TCY4 – 208-230/3/60</b>							
4TCY4036B3000A	38,000	14.20/12.00	450	19.8	30	69	38 x 43 x 51
4TCY4048B3000A	48,500	14.20/11.90	607	26.4	40	72	38 x 46 x 61
4TCY4060A3000B	60,000	14.00/12.00	612	30.6	45	76	42 x 46 x 61

**For dimensional/outline drawings, please refer to Product Data.**

**For information on Roof Curbs, please refer to the Accessories/Information Tab.**

For complete equipment / combination selections, installation instructions and warranty information, please refer to Product Data/Ratings and/or Installers Guides and Limited Warranty Handbooks.



# Packaged Cooling Convertible 2-5 Tons

**Table PK-2-A — Features**

	<b>4TCY5 2-5</b>	<b>4TCY4 2-5</b>
• SEER up to .....	15.00	14.25
• Exclusive <b>Duration™</b> high efficiency compressor with internal overload protection.....	✓	✓
• Factory supplied charge.....	R-410A	R-410A
• Composite <b>Vortica®</b> indoor blower.....	✓	✓
• High efficiency ECM indoor blower motor with <b>Comfort-R™</b> airflow system.....	✓	✓
• All aluminum <b>Spine Fin™</b> outdoor coil.....	✓	✓
• Swept-blade outdoor fan for quiet operation .....	✓	✓
• Architecturally integrated louvers and corner guards.....	✓	✓
• Polyslate gray cabinet .....	✓	✓
• Single stage cool.....	2-3½	✓
• Two stage cooling.....	4,5	—
• High pressure cutout .....	✓	✓
• Low pressure cutout.....	✓	✓
• Liquid line drier - factory installed .....	✓	✓
• Non-bleed expansion valves on indoor coil.....	✓	✓
• Pressure taps, including liquid line taps, easily accessed and protected inside compressor compartment .....	✓	✓
• Right side electrical service access for high and low voltage connections.....	✓	✓
• Rugged steel basepan features deep drawn duct connections .....	✓	✓
• Steeply sloped composite drainpan .....	✓	✓
• Ships in horizontal configuration and converts quickly for downflow .....	✓	✓
• Copper tube, aluminum fin indoor coil .....	3,4,& 5	✓
• All aluminum indoor coil.....	2, 2½, 3½	—
• All models are certified to UL 1995.....	✓	✓
• <b>10-year compressor, 10-year outdoor coil &amp; all other functional parts registered limited warranty (Residential Use)①</b> .....	✓	✓
• <b>Extended warranties available</b> .....	✓	✓

① Registered Limited Warranty terms are available when you register within 60 days of installation. You can register online at americanstandardair.com or by phone at 800-554-8005; otherwise American Standard Heating & Air Conditioning's Base Limited Warranty terms will apply. Base Limited Warranty information on specific products can be found on ASDealerNet.com.

**For dimensional/outline drawings, please refer to Product Data.  
For information on Roof Curbs, please refer to the Accessories/Information Tab.**

# Packaged Cooling Convertible 2-5 Tons

**Table PK-3-A — Accessories**

Model Number	Description	Shipping Weight	4TCY5 2-5	4TCY4 2-5
BAYACCDOR1A	Hinged Filter Access Door <sup>①</sup> .....		2-3	2-3
BAYACCDOR2A	Hinged Filter Access Door <sup>①</sup> .....		3½-5	3½-5
BAYADAP050A	Adapter Curb (Cabinet A/B) .....		2-3	2-3
BAYADAP051A	Adapter Curb (Cabinet C).....		2-3	2-3
BAYADAP052A	Adapter Curb (Cabinet A/B) .....		3½-5	3½-5
BAYADAP053A	Adapter Curb (Cabinet C).....		3½-5	3½-5
BAYADAP054A	Adapter Curb (Cabinet D).....		3½-5	3½-5
BAYASCT001	Anti-Short Cycle Timer <sup>④</sup> .....		✓	✓
BAYCCHT101A	Crankcase Heater (230V) (Reciprocating) .....		—	2-2½
BAYCCHT102A	Crankcase Heater (230V) (Scroll) .....		3½-5	3½-5
BAYCCHT103A	Crankcase Heater (230V) (Scroll) .....		2-3	3
BAYCOVR112A	12" Duct Shroud (Covers Horizontal Ducts) <sup>⑤</sup> .....		2-5	2-5
BAYCOVR118A	18" Duct Shroud (Covers Horizontal Ducts) <sup>⑤</sup> .....		2-5	2-5
BAYCURB050A	Flat Roof Full Perimeter Curb (Insulated) .....	74	2-3	2
BAYCURB051A	Flat Roof Full Perimeter Curb (Insulated) .....	74	3½-5	3½-5
BAYDMPR101A	2-Position Motorized Fresh Air Damper <sup>①⑥⑦⑧⑨</sup> .....		2-3	2-3
BAYDMPR102A	2-Position Motorized Fresh Air Damper <sup>①⑥⑦⑧⑨</sup> .....		3½-5	3½-5
BAYECON101A	Economizer with Barometric Relief (Downflow) <sup>①②③⑨⑩</sup> .....	50	2-3	2-3
BAYECON102A	Economizer with Barometric Relief (Downflow) <sup>①②③⑨⑩</sup> .....	65	3½-5	3½-5
BAYECON104AB	Economizer with Barometric Relief (Downflow) <sup>①②③⑨⑩</sup> .....	65	4-5	—
BAYECON200A	Economizer (Horizontal) <sup>①②③⑥</sup> .....	85	2-3	2-3
BAYECON201A	Economizer (Horizontal) <sup>①②③⑥</sup> .....	85	3½	3½-5
BAYECON204A	Economizer (Horizontal) <sup>①②③⑥</sup> .....	85	4-5	2-5
BAYENTH001A	Enthalpy Control Kit <sup>②</sup> .....	2	✓	✓
BAYEXMK001A	Extreme Conditions Mounting Kit (Used on BAYCURB & BAYADAP).....		✓	✓
BAYEXMK002B	Extreme Conditions Mounting Kit (Used on BAYUTIL) .....		✓	✓
BAYEXMK003A	Extreme Conditions Mounting Kit (Used on Slab Mounts).....		✓	✓
BAYFLTR101C	1-2" Filter Frame (requires one 20x25 filter which is not included) <sup>①</sup> .....	6	2-3	2-3
BAYFLTR201C	1-2" Filter Frame (requires one 20x20 and one 20x18 filter which are not included) <sup>①</sup> .....	6	3½-5	3½-5
BAYLIFT002B	Lifting Lug Kit .....	5	✓	✓
BAYLOAM011A	Evaporator Defrost Control Kit .....		✓	✓
BAYLOAM105A	Low Ambient Control Kit .....	5	✓	✓
BAYOSAH001A	Manual Fresh Air Damper <sup>①</sup> .....	6	2-3	2-3
BAYOSAH002A	Manual Fresh Air Damper <sup>①</sup> .....	8	3½-5	3½-5
BAYQSTK300A	Start Kit .....		1 Phase Only	1 Phase Only
BAYSQRD001A	16" Round Duct Adapter <sup>⑩</sup> .....	5	2-3	2-3
BAYSQRD002A	18" Round Duct Adapter <sup>⑩</sup> .....	3	2-5	2-5
BAYUTIL101B	Roof Curb Utility Extension Kit .....		2-3	2-3
BAYUTIL102B	Roof Curb Utility Extension Kit .....		3½-5	3½-5
BAYUV101A	21" Retrofit UVC Lamp Kit.....	5	2-3	2-3
BAYUV102A	33" Retrofit UVC Lamp Kit.....	5	3½-5	3½-5

- ① Must use filter frame when economizer/fresh air kit is used.
- ② Dry bulb control standard with economizer.
- ③ 2-Stage cooling control required when using economizer.
- ④ Do not use with electronic thermostats.
- ⑤ BAYCOVR112,118A will not cover BAYSQRD002A applications.
- ⑥ Does not contain barometric relief.
- ⑦ Max fresh air - 25%.
- ⑧ For non-continuous fan gas-heating applications, the damper opens only when the OD ambient is above 50° F.
- ⑨ It is the designer/engineer's responsibility to review product specifications prior to equipment selection to insure optimal performance and compliance to codes.
- ⑩ Temperature of mixed air entering the heat exchanger is monitored and fresh air intake may be reduced under certain conditions.
- ⑪ BAYACCDOR1A requires BAYFLTR101B & BAYACCDOR2A requires BAYFLTR201B. They are not backward compatible to BAYFLTR101/201A.

EXISTING CURB	NEW UNIT 4TCY4/5	USE BAYADAP0**A
BAYCURB030,38A	024-036	50
BAYCURB030,38A	042-060	52
BAYCURB033A	024-036	51
BAYCURB033A	024-060	53
BAYCURB034A	042-060	54

**For dimensional/outline drawings, please refer to Product Data.  
For information on Roof Curbs, please refer to the Accessories/Information Tab.**

# Packaged Cooling Convertible 2-5 Tons

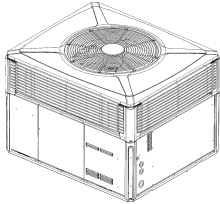

**4TCX3**  
(3-Phase Only)

**Table PK-4-A — 4TCX3 - Gold 13 - Convertible Packaged Cooling - R-410A**

Model Number	Cooling Capacity (Btuh)	SEER/EER	Shipping Weight	MCA	Max Fuse	Sound Rating	Cabinet Dimensions (in.) H x D x W
<b>4TCX3 – 208-230/3/60</b>							
4TCX3036A3000B	36,000	13.20/11.00	450	18.2	30	72	36 x 43 x 51
4TCX3048A3000B	46,500	13.00/11.00	607	23.6	35	72	38 x 46 x 61
4TCX3060A3000B	60,000	13.20/11.00	610	31.7	50	72	40 x 46 x 61
<b>4TCX3 – 460/3/60</b>							
4TCX3036A4000B	36,000	13.20/11.00	450	8.7	15	72	36 x 43 x 51
4TCX3048A4000A	46,500	13.00/11.00	607	11.7	15	72	38 x 46 x 61
4TCX3060A4000B	60,000	13.20/11.00	610	19.5	25	72	40 x 46 x 61

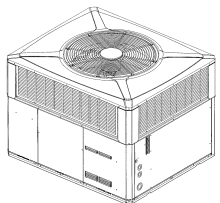

**4TCC4**

**Table PK-4-B— 4TCC4 - Silver 14 - Convertible Packaged Cooling - R-410A**

Model Number	Cooling Capacity (Btuh)	SEER/EER	Shipping Weight	MCA	Max Fuse	Sound Rating	Cabinet Dimensions (in.) H x D x W
<b>4TCC4 – 208-230/1/60</b>							
4TCC4024A1000A	24,600	14.00/12.00	432	19.1	30	67	36 x 43 x 51
4TCC4030A1000A	28,200	14.00/12.00	451	22.6	35	69	36 x 43 x 51
4TCC4036A1000A	37,000	14.00/12.00	453	24.5	40	69	36 x 43 x 51
4TCC4042A1000A	40,500	14.00/12.00	561	28.5	45	75	38 x 46 x 61
4TCC4048A1000A	46,500	14.00/11.50	557	32.0	50	73	38 x 46 x 61
4TCC4060A1000A	58,000	14.00/11.50	586	39.1	60	73	40 x 46 x 61

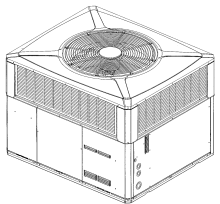

**4TCC3**  
(3-Phase Only)

**Table PK-4-C — 4TCC3 - Silver 13 - Convertible Packaged Cooling - R-410A**

Model Number	Cooling Capacity (Btuh)	SEER/EER	Shipping Weight	MCA	Max Fuse	Sound Rating	Cabinet Dimensions (in.) H x D x W
<b>4TCC3 – 208-230/3/60</b>							
4TCC3036A3000B	35,000	13.00/11.00	450	18.2	30	76	36 x 42 x 49
4TCC3048A3000B	46,500	13.00/11.00	607	23.6	35	80	38 x 45 x 59
4TCC3060A3000B	58,000	13.00/11.00	610	31.7	50	79	40 x 45 x 59
<b>4TCC3 – 460/3/60</b>							
4TCC3036A4000B	35,000	13.00/11.00	450	8.7	15	76	36 x 42 x 49
4TCC3048A4000B	46,500	13.00/11.00	607	11.7	15	80	38 x 45 x 59
4TCC3060A4000B	58,000	13.00/11.00	610	19.5	25	79	40 x 45 x 59

**For dimensional/outline drawings, please refer to Product Data.  
For information on Roof Curbs, please refer to the Accessories/Information Tab.**

# Packaged Cooling Convertible 2-5 Tons

**Table PK-5-A — Features**

	<b>4TCX3 3-5</b>	<b>4TCC4 2-5</b>	<b>4TCC3 3-5</b>
• SEER up to.....	13.20	14.00	13.00
• Exclusive <b>Duration™</b> high efficiency compressor with internal overload protection.....	✓	✓	✓
• Factory supplied charge.....	R-410A	R-410A	R-410A
• Composite <b>Vortica®</b> indoor blower.....	✓	✓	✓
• Direct drive multi-speed indoor blower motors.....	✓	✓	—
• All aluminum <b>Spine Fin™</b> outdoor coil.....	✓	✓	✓
• Swept-blade outdoor fan for quiet operation.....	✓	✓	✓
• Architecturally integrated louvers and corner guards.....	✓	—	✓
• All steel louvers.....	—	✓	✓
• Polyslate gray cabinet.....	✓	✓	✓
• Single stage cool .....	✓	✓	✓
• High pressure cutout .....	✓	✓	✓
• Low pressure cutout.....	3-Phase Only	✓	3-Phase Only
• Liquid line drier - factory installed .....	✓	✓	✓
• Non-bleed expansion valves on indoor coil.....	✓	✓	✓
• Pressure taps, including liquid line taps, easily accessed and protected inside compressor compartment.....	✓	✓	✓
• Right side electrical service access for high and low voltage connections. ....	✓	✓	✓
• Rugged steel basepan features deep drawn duct connections.....	✓	✓	✓
• Steeply sloped composite drainpan.....	✓	✓	✓
• Ships in horizontal configuration and converts quickly for downflow .....	✓	✓	✓
• Copper tube, aluminum fin indoor coil .....	✓	5	✓
• All aluminum indoor coil.....	—	2-4	—
• All models are certified to UL 1995 .....	✓	✓	✓
• <b>10-year compressor, 10-year outdoor coil &amp; all other functional parts registered limited warranty (Residential Use)①</b> .....	✓	✓	✓
• <b>Extended warranties available</b> .....	✓	✓	✓

① Registered Limited Warranty terms are available when you register within 60 days of installation. You can register online at americanstandardair.com or by phone at 800-554-8005; otherwise American Standard Heating & Air Conditioning's Base Limited Warranty terms will apply. Base Limited Warranty information on specific products can be found on ASDealerNet.com.

**For dimensional/outline drawings, please refer to Product Data.  
For information on Roof Curbs, please refer to the Accessories/Information Tab.**

# Packaged Cooling Convertible 2-5 Tons

**Table PK-6-A — Accessories**

Model Number	Description	Shipping Weight	4TCX3 3-5	4TCC4 2-5	4TCC3 3-5
BAYACCDOR1A	Hinged Filter Access Door <sup>⑩</sup> .....		3	2-3	3
BAYACCDOR2A	Hinged Filter Access Door <sup>⑩</sup> .....		4-5	3½-5	4-5
BAYADAP050A	Adapter Curb (Cabinet A/B) .....		3	2-3	3
BAYADAP051A	Adapter Curb (Cabinet C) .....		3	2-3	3
BAYADAP052A	Adapter Curb (Cabinet A/B) .....		4-5	3½-5	4-5
BAYADAP053A	Adapter Curb (Cabinet C) .....		4-5	3½-5	4-5
BAYADAP054A	Adapter Curb (Cabinet D) .....		4-5	3½-5	4-5
BAYASCT001	Anti-Short Cycle Timer <sup>④</sup> .....		✓	—	✓
BAYCCHT102A	Crankcase Heater (230V) (Scroll) .....		4-5	3½-5	4-5
BAYCCHT103A	Crankcase Heater (230V) (Scroll) .....		3	2-3	3
BAYCCHT404B	Crankcase Heater (460V) (Scroll) .....		4-5	—	4-5
BAYCCHT405A	Crankcase Heater (460V) (Scroll) .....		3	—	3
BAYCOVR112A	12" Duct Shroud (Covers Horizontal Ducts) <sup>⑤</sup> .....		3-5	2-5	3-5
BAYCOVR118A	18" Duct Shroud (Covers Horizontal Ducts) <sup>⑤</sup> .....		3-5	2-5	3-5
BAYCURB050A	Flat Roof Full Perimeter Curb (Insulated) .....74.....	74	3	2-3	3
BAYCURB051A	Flat Roof Full Perimeter Curb (Insulated) .....74.....	74	4-5	3½-5	4-5
BAYDMPR101A	2-Position Motorized Fresh Air Damper <sup>①⑥⑦⑧⑨</sup> .....		3	2-3	3
BAYDMPR102A	2-Position Motorized Fresh Air Damper <sup>①⑥⑦⑧⑨</sup> .....		4-5	3½-5	4-5
BAYECON101A	Economizer with Barometric Relief (Downflow) <sup>①②③④⑤⑩</sup> .....50.....	50	3	2-3	3
BAYECON102A	Economizer with Barometric Relief (Downflow) <sup>①②③④⑤⑩</sup> .....65.....	65	4-5	3½-5	4-5
BAYECON200A	Economizer (Horizontal) <sup>①②③④</sup> .....85.....	85	3	2-3	3
BAYECON201A	Economizer (Horizontal) <sup>①②③④</sup> .....85.....	85	4-5	3½-5	4-5
BAYECON204A	Economizer (Horizontal) <sup>①②③④</sup> .....85.....	85	3-5	2-5	3-5
BAYENTH001A	Enthalpy Control Kit <sup>②</sup> .....	2	✓	✓	✓
BAYEXMK001A	Extreme Conditions Mounting Kit (Used on BAYCURB & BAYADAP).....		✓	✓	✓
BAYEXMK002B	Extreme Conditions Mounting Kit (Used on BAYUTIL) .....		✓	✓	✓
BAYEXMK003A	Extreme Conditions Mounting Kit (Used on Slab Mounts) .....		✓	✓	✓
BAYFLTR101C	1-2" Filter Frame (requires one 20x25 filter which is not included) <sup>①</sup> .....6.....	6	3	2-3	3
BAYFLTR201C	1-2" Filter Frame (requires one 20x20 and one 20x18 filter which are not included) <sup>①</sup> .....6.....	6	4-5	3½-5	4-5
BAYLIFT002B	Lifting Lug Kit .....	5	✓	✓	✓
BAYLOAM011A	Evaporator Defrost Control Kit .....		✓	✓	✓
BAYLOAM105A	Low Ambient Control Kit.....5.....	5	✓	✓	✓
BAYLOAM107A	Low Ambient Control Kit.....5.....	5	—	✓	—
BAYOSAH001A	Manual Fresh Air Damper <sup>①</sup> .....6.....	6	3	2-3	3
BAYOSAH002A	Manual Fresh Air Damper <sup>①</sup> .....8.....	8	4-5	3½-5	4-5
BAYQSTK300A	Start Kit .....		—	✓	—
BAYSQRD001A	16" Round Duct Adapter <sup>⑩</sup> .....5.....	5	3	2-3	3
BAYSQRD002A	18" Round Duct Adapter <sup>⑩</sup> .....3.....	3	3-5	2-5	3-5
BAYUTIL101B	Roof Curb Utility Extension Kit .....		3	2-3	3
BAYUTIL102B	Roof Curb Utility Extension Kit .....		4-5	3½-5	4-5
BAYUV101A	21" Retrofit UVC Lamp Kit.....5.....	5	3	2-3	3
BAYUV102A	33" Retrofit UVC Lamp Kit.....5.....	5	4-5	3½-5	4-5

- ① Must use filter frame when economizer/fresh air kit is used.
- ② Dry bulb control standard with economizer.
- ③ 2-Stage cooling control required when using economizer.
- ④ Do not use with electronic thermostats.
- ⑤ BAYCOVR112,118A will not cover BAYSQRD002A applications.
- ⑥ Does not contain barometric relief.
- ⑦ Max fresh air - 25%.
- ⑧ For non-continuous fan gas-heating applications, the damper opens only when the OD ambient is above 50° F.
- ⑨ It is the designer/engineer's responsibility to review product specifications prior to equipment selection to insure optimal performance and compliance to codes.
- ⑩ Temperature of mixed air entering the heat exchanger is monitored and fresh air intake may be reduced under certain conditions.
- ⑪ BAYACCDOR1A requires BAYFLTR101B & BAYACCDOR2A requires BAYFLTR201B. They are not backward compatible to BAYFLTR101/201A.

EXISTING CURB	NEW UNIT 4TC**	USE BAYADAP0**A
BAYCURB030,38A	024-036	50
BAYCURB030,38A	042-060	52
BAYCURB033A	024-036	51
BAYCURB033A	024-060	53
BAYCURB034A	042-060	54

**For dimensional/outline drawings, please refer to Product Data.  
For information on Roof Curbs, please refer to the Accessories/Information Tab.**

For complete equipment / combination selections, installation instructions and warranty information, please refer to Product Data/Ratings and/or Installers Guides and Limited Warranty Handbooks.

# Packaged Heat Pump/Dual Fuel Convertible 2-5 Tons

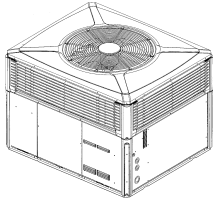

**4WCZ6**

**Table PK-7-A — 4WCZ6 - Platinum 16 - Convertible Packaged Heat Pump - R-410A**

Model Number	Capacity	SEER	EER High/Low	HSPF	Shipping Weight	MCA	Max Fuse	Sound Rating	Cabinet Dimensions (in.) H x D x W
<b>4WCZ6 – 208-230/1/60</b>									
4WCZ6036B1000A	36,000	16.00	12.20/17.45	8.30	468	24.3	35	70	38 x 43 x 51
4WCZ6048B1000A	47,500	16.00	12.00/17.50	8.50	607	34.2	50	72	42 x 46 x 61
4WCZ6060B1000A	57,000	15.00	11.50/15.90	8.30	623	42.0	60	74	42 x 46 x 61
<b>4WCZ6 – 208-230/3/60</b>									
4WCZ6036B3000A	36,000	16.00	12.20/17.45	8.30	468	19.7	30	70	38 x 43 x 51
4WCZ6048B3000A	47,500	16.00	12.00/17.50	8.50	607	25.2	35	72	42 x 46 x 61
4WCZ6060B3000A	57,000	15.00	11.50/15.90	8.30	623	30.0	45	74	42 x 46 x 61
<b>4WCZ6 – 460/3/60</b>									
4WCZ6036B4000A	36,000	16.00	12.20/17.45	8.30	468	11.9	15	70	38 x 43 x 51
4WCZ6048B4000A	47,500	16.00	12.00/17.50	8.50	607	15.3	20	72	42 x 46 x 61
4WCZ6060B4000A	57,000	15.00	11.50/15.90	8.30	623	17.0	20	74	42 x 46 x 61

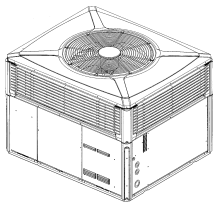

**4DCZ6**

**Table PK-7-B — 4DCZ6 - Platinum 16 - Convertible Packaged Heat Pump/Dual Fuel - R-410A**

Model Number	Cooling Capacity (BTUH)	Gas Capacity Heating Output (1 Stg./2 Stg.)	SEER/EER	HSPF	AFUE(%)	Shipping Weight	MCA	Max Fuse	Sound Rating	Cabinet Dimensions (in.) H x D x W
<b>4DCZ6 – 208-230/1/60</b>										
4DCZ6036C1070A	36,000	45,000/57,000	16.00 /12.20	8.30	81.0	488	24.3	35	70	38 x 43 x 51
4DCZ6048C1090A	47,500	58,000/73,000	16.00 /12.00	8.50	81.0	665	34.2	50	72	42 x 46 x 61
4DCZ6060C1115A	57,000	75,000/93,000	15.00 /11.50	8.30	81.0	676	42.0	60	74	42 x 46 x 61
<b>4DCZ6 – 208-230/3/60</b>										
4DCZ6036B3075A	36,000	48,400/60,000	16.00 /12.20	8.30	79.5	488	19.7	30	70	38 x 43 x 51
4DCZ6048B3096A	47,500	62,000/77,000	16.00 /12.00	8.50	80.0	665	25.2	35	72	42 x 46 x 61
4DCZ6060B3120A	57,000	77,500/96,000	15.00 /11.50	8.30	80.0	676	30.0	45	74	42 x 46 x 61

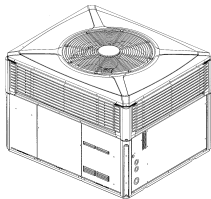

**4DCY4**

**Table PK-7-C — 4DCY4 - Gold 14 - Convertible Packaged Heat Pump/Dual Fuel - R-410A**

Model Number	Cooling Capacity (BTUH)	Gas Capacity Heating Output (1 Stg./2 Stg.)	SEER/EER	HSPF	AFUE(%)	Shipping Weight	MCA	Max Fuse	Sound Rating	Cabinet Dimensions (in.) H x D x W
<b>4DCY4 – 208-230/1/60</b>										
4DCY4024C1060A	23,600	39,000/49,000	14.00/12.00	8.00	81.0	481	16.1	25	68	36 x 43 x 51
4DCY4030C1070A	30,000	45,000/57,000	14.25/12.00	8.00	81.0	481	19.1	30	76	36 x 43 x 51
4DCY4036C1070A	37,000	45,000/57,000	14.00/12.00	8.00	81.0	488	24.6	40	69	38 x 43 x 51
4DCY4042C1090A	42,000	58,000/73,000	14.00/12.00	8.00	81.0	653	30.8	45	74	38 x 46 x 61
4DCY4048C1090A	47,500	58,000/73,000	14.00/12.00	8.00	81.0	653	33.9	50	73	38 x 46 x 61
4DCY4060C1115A	58,000	75,000/93,000	14.00/12.00	8.00	81.0	676	39.9	60	76	42 x 46 x 61
<b>4DCY4 – 208-230/3/60</b>										
4DCY4036B3075A	36,000	48,400/60,000	14.00/11.40	8.00	79.5	488	19.8	30	69	36 x 43 x 51
4DCY4048A3096C	47,000	62,000/77,000	14.00/10.80	8.00	80.0	653	26.4	40	73	38 x 46 x 61
4DCY4060A3120C	57,500	77,500/96,000	14.00/11.50	8.00	80.0	676	30.6	60	76	42 x 46 x 61

For dimensional/outline drawings, please refer to Product Data.

For information on Roof Curbs, please refer to the Accessories/Information Tab.

For complete equipment / combination selections, installation instructions and warranty information, please refer to Product Data/Ratings and/or Installers Guides and Limited Warranty Handbooks.



# Packaged Heat Pump/Dual Fuel Convertible 2-5 Tons

**Table PK-8-A — Features**

	4WCZ6 3-5	4DCZ6 3-5	4DCY4 2-5
• SEER up to.....	16.00	16.00	14.25
• HSPF up to.....	8.50	8.50	8.00
• Exclusive <b>Duration™</b> high efficiency compressor with internal overload protection.....	✓	✓	✓
• Factory supplied charge.....	R-410A	R-410A	R-410A
• Composite <b>Vortica®</b> indoor blower.....	✓	✓	✓
• High efficiency ECM indoor blower motor with <b>Comfort-R™</b> airflow system.....	✓	✓	✓
• All aluminum <b>Spine Fin™</b> outdoor coil.....	✓	✓	✓
• Swept-blade outdoor fan for quiet operation.....	✓	✓	✓
• Architecturally integrated louvers and corner guards.....	✓	✓	✓
• Polyslate gray cabinet.....	✓	✓	✓
• Stainless steel heat exchanger and burners.....	—	✓	✓
• Single stage heating and cool.....	—	—	✓
• 2-stage heating and cooling.....	✓	✓	—
• 2-stage gas.....	—	✓	✓
• Start kit - factory installed (single phase only).....	—	—	2 & 2½
• High pressure cutout.....	✓	✓	✓
• Low pressure cutout.....	✓	✓	✓
• Liquid line drier - factory installed.....	✓	✓	✓
• Non-bleed expansion valves on indoor and outdoor coils.....	✓	✓	✓
• Pressure taps, including liquid line taps, easily accessed and protected inside compressor compartment.....	✓	✓	✓
• Right side electrical service access for high and low voltage connections.....	✓	✓	✓
• Rugged steel basepan features deep drawn duct connections.....	✓	✓	✓
• Steeply sloped composite drainpan.....	✓	✓	✓
• Ships in horizontal configuration and converts quickly for downflow.....	✓	✓	✓
• Copper tube, aluminum fin indoor coil.....	✓	✓	✓
• All models are certified to UL 1995.....	✓	✓	✓
• <b>20-year heat exchanger, 12-year compressor, 10-year outdoor coil, &amp; 10-year all other functional parts registered limited warranty (Residential Use)①</b> .....	—	✓	—
• <b>20-year heat exchanger, 10-year compressor, 10-year outdoor coil, &amp; 10-year all other functional parts registered limited warranty (Residential Use)①</b> .....	—	—	✓
• <b>12-year compressor, 10-year outdoor coil, &amp; 10-year all other functional parts registered limited warranty (Residential Use)①</b> .....	✓	—	—
• <b>Extended Warranties Available</b> .....	✓	✓	✓

① Registered Limited Warranty terms are available when you register within 60 days of installation. You can register online at americanstandardair.com or by phone at 800-554-8005; otherwise American Standard Heating & Air Conditioning's Base Limited Warranty terms will apply. Base Limited Warranty information on specific products can be found on ASDealerNet.com.

**For dimensional/outline drawings, please refer to Product Data.  
For information on Roof Curbs, please refer to the Accessories/Information Tab.**

# Packaged Heat Pump/Dual Fuel Convertible 2-5 Tons

Table PK-9-A — Accessories			4WCZ6 3-5	4DCZ6 3-5	4DCY4 2-5
Model Number	Description	Shipping Weight			
BAYACCDOR1A	Hinged Filter Access Door <sup>®</sup>		3	3	2-3
BAYACCDOR2A	Hinged Filter Access Door <sup>®</sup>		4-5	4-5	3½-5
BAYADAP050A	Adapter Curb (Cabinet A/B)		3	3	2-3
BAYADAP051A	Adapter Curb (Cabinet C)		3	3	2-3
BAYADAP052A	Adapter Curb (Cabinet A/B)		4-5	4-5	3½-5
BAYADAP053A	Adapter Curb (Cabinet C)		4-5	4-5	3½-5
BAYADAP054A	Adapter Curb (Cabinet D)		4-5	4-5	3½-5
BAYASCT001	Anti-Short Cycle Timer <sup>④</sup>		✓	✓	✓
BAYCCHT101A	Crankcase Heater (230V) (Reciprocating)		—	—	2-2½
BAYCCHT102A	Crankcase Heater (230V) (Scroll)		4,5	4,5	3½-5
BAYCCHT103A	Crankcase Heater (230V) (Scroll)		3	3	3
BAYCCHT404B	Crankcase Heater (460V) (Scroll)		4,5	4,5	—
BATCCHT405A	Crankcase Heater (460V) (Scroll)		3	3	—
BAYCOVR112A	12" Duct Shroud (Covers Horizontal Ducts) <sup>⑥</sup>		3-5	3-5	2-5
BAYCOVR118A	18" Duct Shroud (Covers Horizontal Ducts) <sup>⑥</sup>		3-5	3-5	2-5
BAYCURB050A	Flat Roof Full Perimeter Curb (Insulated)	.74	2-3	3	2-3
BAYCURB051A	Flat Roof Full Perimeter Curb (Insulated)	.74	3-5	4-5	3½-5
BAYDMPR101A	2-Position Motorized Damper <sup>②⑦⑧⑨⑩</sup>		2-3	3	2-3
BAYDMPR102A	2-Position Motorized Damper <sup>②⑦⑧⑨⑩</sup>		4-5	4-5	3½-5
BAYECON101A	Economizer with Barometric Relief (Downflow) <sup>①②③④⑤⑥⑪</sup>		—	—	2-3
BAYECON102A	Economizer with Barometric Relief (Downflow) <sup>①②③④⑤⑥⑪</sup>		—	—	3½-5
BAYECON103A	Economizer with Barometric Relief (Downflow) <sup>①②③④⑤⑥⑪</sup>	.50	3	3	—
BAYECON104A	Economizer with Barometric Relief (Downflow) <sup>①②③④⑤⑥⑪</sup>	.65	4-5	4-5	—
BAYECON200A	Economizer (Horizontal) <sup>①②③④⑦</sup>		—	—	2-3
BAYECON201A	Economizer (Horizontal) <sup>①②③④⑦</sup>		—	—	3½-5
BAYECON203A	Economizer (Horizontal) <sup>①②③④⑦</sup>	.85	3	3	—
BAYECON204A	Economizer (Horizontal) <sup>①②③④⑦</sup>	.85	4-5	4-5	—
BAYENTH001A	Enthalpy Control Kit <sup>③</sup>	.2	✓	✓	✓
BAYEXMK001A	Extreme Conditions Mounting Kit		✓	✓	✓
BAYEXMK002B	Extreme Conditions Mounting Kit		✓	✓	✓
BAYEXMK003A	Extreme Conditions Mounting Kit (Used on Slab Mounts)		✓	✓	✓
BAYFLTR101C	1-2" Filter Frame <sup>②</sup> -Requires one 20x25 filter (not included)	.6	3	3	2-3
BAYFLTR201C	1-2" Filter Frame <sup>②</sup> -Requires one 20x20, and one 20x18 filters (not included)	.6	4-5	4-5	3½-5
BAYLIFT002B	Lifting Lug Kit	.5	✓	✓	✓
BAYLOAM105A	Low Ambient Control Kit	.5	✓	✓	✓
BAYRLAY004A	Economizer Relay <sup>①</sup>		—	—	✓
BAYRLAY006A	Economizer Relay <sup>①</sup>	.1	✓	✓	—
BAYOSAC001B	Outside Air Control for V.S. Economizer <sup>③</sup>		3,4,5	3,4,5	—
BAYOSAH001A	Manual Fresh Air Damper <sup>②</sup>	.6	3	3	2-3
BAYOSAH002A	Manual Fresh Air Damper <sup>②</sup>	.8	4-5	4-5	3½-5
BAYQSTK300A	Start Kit		—	—	1 Phase Only
BAYSQRD001A	16" Round Duct Adapter <sup>⑤</sup>	.5	3	3	2-3
BAYSQRD002A	18" Round Duct Adapter <sup>⑤</sup>	.3	4-5	4-5	2-5
BAYUTIL101B	Roof Curb Extension Kit		3	3	2-3
BAYUTIL102B	Roof Curb Extension Kit		4-5	4-5	3½-5
BAYUV101A	21" Retrofit UVC Lamp Kit	.5	3	3	1½-3
BAYUV102A	33" Retrofit UVC Lamp Kit	.5	4-5	4-5	3½-5

- ① Relay required with economizer on all heat pump applications.
- ② Must use filter frame when economizer/fresh air kit is used.
- ③ Dry bulb control standard with economizer.
- ④ 2-Stage cooling control required when using economizer.
- ⑤ It is the responsibility of the installing dealer to properly size the ductwork for each specific application.
- ⑥ BAYCOVR112,118A will not cover BAYSQRD002A applications.
- ⑦ Does not contain barometric relief.
- ⑧ Max fresh air - 25%.
- ⑨ For non-continuous fan gas-heating applications, the damper opens only when the OD ambient is above 50° F.
- ⑩ It is the designer/engineer's responsibility to review product specifications prior to equipment selection to insure optimal performance and compliance to codes.
- ⑪ Temperature of mixed air entering the heat exchanger is monitored and fresh air intake may be reduced under certain conditions.
- ⑫ BAYACCDOR1A requires BAYFLTR101B & BAYACCDOR2A requires BAYFLTR201B. They are not backward compatible to BAYFLTR101/201A.
- ⑬ BAYOSAC001B is not compatible with BAYACCDOR1A or BAYACCDOR2A.

EXISTING CURB	NEW UNIT 4WC/DC**A	USE BAYADAP**A
BAYCURB030,38A	024-036	50
BAYCURB030,38A	024-036	52
BAYCURB030,38A	024-036	51
BAYCURB030,38A	024-036	53
BAYCURB030,38A	024-036	54

**For dimensional/outline drawings, please refer to Product Data.  
For information on Roof Curbs, please refer to the Accessories/Information Tab.**

For complete equipment / combination selections, installation instructions and warranty information, please refer to Product Data/Ratings and/or Installers Guides and Limited Warranty Handbooks.



# Packaged Heat Pump Convertible 2-5 Tons

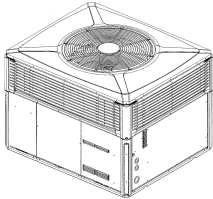

**4WCY5**

**Table PK-10-A — 4WCY5 - Gold 15 - Convertible Packaged Heat Pump - R-410A**

Model Number	Capacity	SEER/EER	HSPF	Shipping Weight	MCA	Max Fuse	Sound Rating	Cabinet Dimensions (in.) H x D x W
<b>4WCY5 – 208-230/1/60</b>								
4WCY5024A1000A	-	15.00/12.00	8.20	-	-	-	-	36 x 43 x 51
4WCY5030A1000A	-	15.25/12.00	8.20	-	-	-	-	38 x 43 x 51
4WCY5036A1000A	-	15.00/12.00	8.20	-	-	-	-	38 x 43 x 51
4WCY5042A1000A	-	15.00/12.00	8.20	-	-	-	-	38 x 46 x 61
4WCY5048A1000A	-	15.00/12.00	8.20	-	-	-	-	42 x 46 x 61
4WCY5060A1000A	-	15.00/11.50	8.20	-	-	-	-	42 x 46 x 61

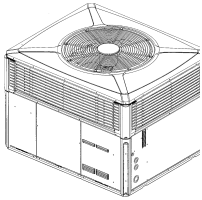

**4WCY4**

**Table PK-10-B — 4WCY4 - Gold 14 - Convertible Packaged Heat Pump - R-410A**

Model Number	Capacity	SEER/EER	HSPF	Shipping Weight	MCA	Max Fuse	Sound Rating	Cabinet Dimensions (in.) H x D x W
<b>4WCY4 – 208-230/1/60</b>								
4WCY4024A1000B	23,600	14.00/12.00	8.00	453	16.1	25	68	36 x 43 x 51
4WCY4030A1000B	30,000	14.25/12.00	8.00	453	19.2	30	71	36 x 43 x 51
4WCY4036C1000A	37,000	14.00/12.00	8.00	468	24.6	40	69	38 x 43 x 51
4WCY4042B1000A	42,000	14.00/12.00	8.00	607	30.6	45	74	38 x 46 x 61
4WCY4048B1000B	47,500	14.00/12.00	8.00	607	33.9	50	73	38 x 46 x 61
4WCY4060B1000C	58,000	14.00/12.00	8.00	623	39.9	60	76	42 x 46 x 61
<b>4WCY4 – 208-230/3/60</b>								
4WCY4036B3000A	36,000	14.00/11.70	8.00	468	19.8	30	69	38 x 43 x 51
4WCY4048A3000C	47,000	14.00/11.75	8.00	607	26.4	40	73	38 x 46 x 61
4WCY4060A3000C	58,000	14.00/11.50	8.00	623	30.6	45	76	42 x 46 x 61

# Packaged Heat Pump Convertible 2-5 Tons

**Table PK-11-A — Features**

	4WCY5 2-5	4WCY4 2-5
• SEER up to.....	15.00	14.25
• HSPF up to.....	8.20	8.00
• Exclusive <b>Duration™</b> high efficiency compressor with internal overload protection.....	✓	✓
• Factory supplied charge.....	R-410A	R-410A
• Composite <b>Vortica®</b> indoor blower.....	✓	✓
• High efficiency ECM indoor blower motor with <b>Comfort-R™</b> airflow system.....	✓	✓
• All aluminum <b>Spine Fin™</b> outdoor coil.....	✓	✓
• Swept-blade outdoor fan for quiet operation.....	✓	✓
• Architecturally integrated louvers and corner guards.....	✓	✓
• Polyslate gray cabinet.....	✓	✓
• Single stage heating and cooling.....	2 - 3½	✓
• Two stage heating and cooling.....	4, 5	✓
• Start kit - factory installed (single phase only).....	2, 2½	2, 2½
• High pressure cutout.....	✓	✓
• Low pressure cutout.....	✓	✓
• Liquid line drier - factory installed.....	✓	✓
• Non-bleed expansion valves on indoor and outdoor coils.....	✓	✓
• Pressure taps, including liquid line taps, easily accessed and protected inside compressor compartment.....	✓	✓
• Right side electrical service access for high and low voltage connections.....	✓	✓
• Rugged steel basepan features deep drawn duct connections.....	✓	✓
• Steeply sloped composite drainpan.....	✓	✓
• Ships in horizontal configuration and converts quickly for downflow.....	✓	✓
• Copper tube, aluminum fin indoor coil.....	✓	✓
• All models are certified to UL 1995.....	✓	✓
• <b>10-year compressor, 10-year outdoor coil, &amp; 10-year all other functional parts registered limited warranty (Residential Use)①</b> .....	✓	✓
• <b>Extended Warranties Available</b> .....	✓	✓

① Registered Limited Warranty terms are available when you register within 60 days of installation. You can register online at americanstandardair.com or by phone at 800-554-8005; otherwise American Standard Heating & Air Conditioning's Base Limited Warranty terms will apply. Base Limited Warranty information on specific products can be found on ASDealerNet.com.

**For dimensional/outline drawings, please refer to Product Data.  
For information on Roof Curbs, please refer to the Accessories/Information Tab.**

# Packaged Heat Pump Convertible 2-5 Tons

**Table PK-12-A — Accessories**

Model Number	Description	Shipping Weight	4WCY5	4WCY4
			2-5	2-5
BAYACCDOR1A	Hinged Filter Access Door®		2-3	2-3
BAYACCDOR2A	Hinged Filter Access Door®		3½-5	3½-5
BAYADAP050A	Adapter Curb (Cabinet A/B)		2-3	2-3
BAYADAP051A	Adapter Curb (Cabinet C)		2-3	2-3
BAYADAP052A	Adapter Curb (Cabinet A/B)		3½-5	3½-5
BAYADAP053A	Adapter Curb (Cabinet C)		3½-5	3½-5
BAYADAP054A	Adapter Curb (Cabinet D)		3½-5	3½-5
BAYASCT001	Anti-Short Cycle Timer③		✓	✓
BAYCCHT101A	Crankcase Heater (230V) (Reciprocating)		2-2½	2-2½
BAYCCHT102A	Crankcase Heater (230V) (Scroll)		3½-5	3½-5
BAYCCHT103A	Crankcase Heater (230V) (Scroll)		3	3
BAYCOVR112A	12" Duct Shroud (Covers Horizontal Ducts)⑥		2-5	2-5
BAYCOVR118A	18" Duct Shroud (Covers Horizontal Ducts)⑥		2-5	2-5
BAYCURB050A	Flat Roof Full Perimeter Curb (Insulated)	.74	2-3	2-3
BAYCURB051A	Flat Roof Full Perimeter Curb (Insulated)	.74	3½-5	3½-5
BAYDMPR101A	2-Position Motorized Damper②⑦⑧⑨⑩		2-3	2-3
BAYDMPR102A	2-Position Motorized Damper②⑦⑧⑨⑩		3½-5	3½-5
BAYECON101A	Economizer with Barometric Relief (Downflow)①②③④⑤⑥		2-3	2-3
BAYECON102A	Economizer with Barometric Relief (Downflow)①②③④⑤⑥		3½-5	3½-5
BAYECON103A	Economizer with Barometric Relief (Downflow)①②③④⑤⑥	.50	—	—
BAYECON104A	Economizer with Barometric Relief (Downflow)①②③④⑤⑥	.65	—	—
BAYECON200A	Economizer (Horizontal)①②③④⑦		2-3	2-3
BAYECON201A	Economizer (Horizontal)①②③④⑦		3½-5	3½-5
BAYENTH001A	Enthalpy Control Kit③	.2	✓	✓
BAYEXMK001A	Extreme Conditions Mounting Kit		✓	✓
BAYEXMK002B	Extreme Conditions Mounting Kit		✓	✓
BAYEXMK003A	Extreme Conditions Mounting Kit (Used on Slab Mounts)		✓	✓
BAYFLTR101C	1-2" Filter Frame②-Requires one 20x25 filter (not included)	.6	2-3	2-3
BAYFLTR201C	1-2" Filter Frame②-Requires one 20x20, and one 20x18 filters (not included)	.6	3½-5	3½-5
BAYLIFT002B	Lifting Lug Kit	.5	✓	✓
BAYLOAM105A	Low Ambient Control Kit	.5	✓	✓
BAYRLAY004A	Economizer Relay①		✓	✓
BAYOSAH001A	Manual Fresh Air Damper②	.6	2-3	2-3
BAYOSAH002A	Manual Fresh Air Damper②	.8	3½-5	3½-5
BAYQSTK300A	Start Kit		1 Phase Only	1 Phase Only
BAYSQRD001A	16" Round Duct Adapter⑧	.5	2-3	2-3
BAYSQRD002A	18" Round Duct Adapter⑧	.3	2-5	2-5
BAYUTIL101B	Roof Curb Extension Kit		2-3	2-3
BAYUTIL102B	Roof Curb Extension Kit		3½-5	3½-5
BAYUV101A	21" Retrofit UVC Lamp Kit	.5	2-3	2-3
BAYUV102A	33" Retrofit UVC Lamp Kit	.5	3½-5	3½-5

- ① Relay required with economizer on all heat pump applications.
- ② Must use filter frame when economizer/fresh air kit is used.
- ③ Dry bulb control standard with economizer.
- ④ 2-Stage cooling control required when using economizer.
- ⑤ It is the responsibility of the installing dealer to properly size the ductwork for each specific application.
- ⑥ BAYCOVR112,118A will not cover BAYSQRD002A applications.
- ⑦ Does not contain barometric relief.
- ⑧ Max fresh air - 25%.
- ⑨ For non-continuous fan gas-heating applications, the damper opens only when the OD ambient is above 50° F.
- ⑩ It is the designer/engineer's responsibility to review product specifications prior to equipment selection to insure optimal performance and compliance to codes.
- ⑪ Temperature of mixed air entering the heat exchanger is monitored and fresh air intake may be reduced under certain conditions.
- ⑫ BAYACCDOR1A requires BAYFLTR101B & BAYACCDOR2A requires BAYFLTR201B. They are not backward compatible to BAYFLTR101/201A.
- ⑬ BAYOSAC001B is not compatible with BAYACCDOR1A or BAYACCDOR2A.

EXISTING CURB	NEW UNIT 4WCY*A	USE BAYADAP0**A
BAYCURB030,38A	024-036	50
BAYCURB030,38A	024-036	52
BAYCURB030,38A	024-036	51
BAYCURB030,38A	024-036	53
BAYCURB030,38A	024-036	54

**For dimensional/outline drawings, please refer to Product Data.  
For information on Roof Curbs, please refer to the Accessories/Information Tab.**

For complete equipment / combination selections, installation instructions and warranty information, please refer to Product Data/Ratings and/or Installers Guides and Limited Warranty Handbooks.

# Packaged Heat Pump Convertible 2-5 Tons

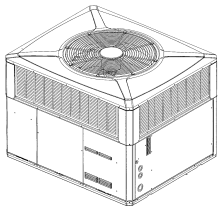

**4WCC4**

**Table PK-13-A — 4WCC4 - Silver 14 - Convertible Packaged Heat Pump - R-410A**

Model Number	Capacity	SEER/EER	HSPF	Shipping Weight	MCA	Max Fuse	Sound Rating	Cabinet Dimensions (in.) H x D x W
<b>4WCC4 – 208-230/1/60</b>								
4WCC4024A1000A	24,600	14.00/12.00	8.00	402	19.4	30	66	36 x 42 x 49
4WCC4030A1000A	30,400	14.00/12.00	8.00	430	22.6	35	69	36 x 42 x 49
4WCC4036A1000A	35,800	14.00/12.00	8.00	439	24.4	40	69	36 x 42 x 49
4WCC4042A1000A	43,000	14.00/12.00	8.00	548	28.3	45	71	38 x 45 x 59
4WCC4048A1000A	48,000	14.00/12.00	8.00	529	31.9	50	82	38 x 45 x 59
4WCC4060A1000A	58,000	14.00/12.00	8.00	594	39.0	60	77	40 x 45 x 59

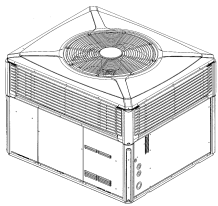

**4WCX3  
(3-Phase Only)**

**Table PK-15-B — 4WCX3 - Gold 13 - Convertible Packaged Heat Pump - R-410A**

Model Number	Capacity	SEER/EER	HSPF	Shipping Weight	MCA	Max Fuse	Sound Rating	Cabinet Dimensions (in.) H x D x W
<b>4WCX3 – 208-230/3/60</b>								
4WCX3036A3000B	35,000	13.00/11.00	7.70	468	18.2	30	71	36 x 43 x 51
4WCX3048A3000A	46,000	13.00/10.75	7.70	553	23.6	35	73	38 x 46 x 61
4WCX3060A3000B	58,000	13.00/10.85	7.70	618	31.7	50	72	40 x 46 x 61
<b>4WCX3 – 460/3/60</b>								
4WCX3036A4000B	35,000	13.00/11.00	7.70	468	8.7	15	71	36 x 43 x 51
4WCX3048A4000A	46,000	13.00/10.75	7.70	553	11.7	15	73	38 x 46 x 61
4WCX3060A4000B	58,000	13.00/10.85	7.70	618	19.5	25	72	40 x 46 x 61

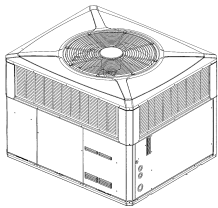

**4WCC3  
(3-Phase Only)**

**Table PK-13-C — 4WCC3 - Silver 13 - Convertible Packaged Heat Pump - R-410A**

Model Number	Capacity	SEER/EER	HSPF	Shipping Weight	MCA	Max Fuse	Sound Rating	Cabinet Dimensions (in.) H x D x W
<b>4WCC3 – 208-230/3/60</b>								
4WCC3036A3000B	35,000	13.00/11.00	7.70	468	18.2	30	75	36 x 42 x 49
4WCC3048A3000B	46,000	13.00/10.75	7.70	553	23.6	35	80	38 x 45 x 59
4WCC3060A3000B	58,000	13.00/10.85	7.70	618	31.7	50	79	40 x 45 x 59
<b>4WCC3 – 460/3/60</b>								
4WCC3036A4000B	35,000	13.00/11.00	7.70	468	8.7	15	75	36 x 42 x 49
4WCC3048A4000B	46,000	13.00/10.75	7.70	553	11.7	15	80	38 x 45 x 59
4WCC3060A4000B	58,000	13.00/10.85	7.70	618	19.5	25	79	40 x 45 x 59

**For dimensional/outline drawings, please refer to Product Data.  
For information on Roof Curbs, please refer to the Accessories/Information Tab.**

For complete equipment / combination selections, installation instructions and warranty information, please refer to Product Data/Ratings and/or Installers Guides and Limited Warranty Handbooks.

# Packaged Heat Pump Convertible 2-5 Tons

**Table PK-14-A — Features**

	<b>4WCC4 2-5</b>	<b>4WCX3 3-5</b>	<b>4WCC3 3-5</b>
• SEER up to .....	14.00	13.00	13.00
• HSPF up to .....	8.00	7.70	7.70
• Exclusive <b>Duration™</b> high efficiency compressor with internal overload protection.....	—	✓	—
• Factory supplied charge .....	R-410A	R-410A	R-410A
• Composite <b>Vortica®</b> indoor blower.....	✓	✓	✓
• Direct drive multi-speed indoor blower motors.....	✓	✓	✓
• All aluminum <b>Spine Fin™</b> outdoor coil .....	✓	✓	✓
• Swept-blade outdoor fan for quiet operation .....	—	✓	—
• Architecturally integrated louvers and corner guards.....	—	✓	—
• All steel louvers .....	✓	—	✓
• Polyslate gray cabinet .....	✓	✓	✓
• Single stage cool.....	✓	✓	✓
• High pressure cutout.....	✓	✓	✓
• Low pressure cutout.....	✓	✓	✓
• Liquid line drier - factory installed .....	✓	✓	✓
• Non-bleed expansion valves on indoor and outdoor coils .....	✓	✓	✓
• Pressure taps, including liquid line taps, easily accessed and protected inside compressor compartment ...	✓	✓	✓
• Right side electrical service access for high and low voltage connections.....	✓	✓	✓
• Rugged steel basepan features deep drawn duct connections .....	✓	✓	✓
• Steeply sloped composite drainpan .....	✓	✓	✓
• Ships in horizontal configuration and converts quickly for downflow .....	✓	✓	✓
• Copper tube, aluminum fin indoor coil .....	✓	✓	✓
• All models are certified to UL 1995 .....	✓	✓	✓
• <b>10-year compressor, 10-year outdoor coil, &amp; 10-year all other functional parts registered limited warranty (Residential Use)①</b> .....	✓	✓	✓
• <b>Extended warranties available</b> .....	✓	✓	✓

① Registered Limited Warranty terms are available when you register within 60 days of installation. You can register online at [americanstandardair.com](http://americanstandardair.com) or by phone at 800-554-8005; otherwise American Standard Heating & Air Conditioning's Base Limited Warranty terms will apply. Base Limited Warranty information on specific products can be found on [ASDealerNet.com](http://ASDealerNet.com).

**For dimensional/outline drawings, please refer to Product Data.  
For information on Roof Curbs, please refer to the Accessories/Information Tab.**

# Packaged Heat Pump Convertible 2-5 Tons

**Table PK-15-A — Accessories**

Model Number	Description	Shipping Weight	4WCC4 2-5	4WCX3 3-5	4WCC3 3-5
BAYACCDOR1A	Hinged Filter Access Door <sup>(14)</sup>		2-3	3	3
BAYACCDOR2A	Hinged Filter Access Door <sup>(14)</sup>		3½-5	4-5	4-5
BAYADAP050A	Adapter Curb (Cabinet A/B)		2-3	3	3
BAYADAP051A	Adapter Curb (Cabinet C)		2-3	3	3
BAYADAP052A	Adapter Curb (Cabinet A/B)		3½-5	4-5	4-5
BAYADAP053A	Adapter Curb (Cabinet C)		3½-5	4-5	4-5
BAYADAP054A	Adapter Curb (Cabinet D)		3½-5	4-5	4-5
BAYASCT001	Anti-Short Cycle Timer <sup>(5)</sup>		✓	✓	✓
BAYCCHT102A	Crankcase Heater (230V) (Scroll)		3½-5	4-5	4-5
BATCCHT103A	Crankcase Heater (230V) (Scroll)		2-3	3	3
BAYCCHT404B	Crankcase Heater (460V) (Scroll)		—	4-5	4-5
BAYCCHT405A	Crankcase Heater (460V) (Scroll)		—	3	3
BAYCOVR112A	12" Duct Shroud (Covers Horizontal Ducts) <sup>(8)</sup>		2-5	3-5	3-5
BAYCOVR118A	18" Duct Shroud (Covers Horizontal Ducts) <sup>(8)</sup>		2-5	3-5	3-5
BAYCURB050A	Flat Roof Full Perimeter Curb (Insulated)	74	2-3	3	3
BAYCURB051A	Flat Roof Full Perimeter Curb (Insulated)	74	3½-5	4-5	4-5
BAYDMPR101A	2-Position Motorized Damper <sup>(2)(9)(10)(11)(12)</sup>		2-3	3	3
BAYDMPR102A	2-Position Motorized Damper <sup>(2)(9)(10)(11)(12)</sup>		3½-5	4-5	4-5
BAYECON101A	Economizer with Barometric Relief (Downflow) <sup>(1)(2)(4)(5)(12)(13)</sup>		2-3	3	3
BAYECON102A	Economizer with Barometric Relief (Downflow) <sup>(1)(2)(4)(5)(12)(13)</sup>		3½-5	4-5	4-5
BAYECON200A	Economizer (Horizontal) <sup>(1)(2)(4)(5)(9)</sup>		2-3	3	3
BAYECON201A	Economizer (Horizontal) <sup>(1)(2)(4)(5)(9)</sup>		3½-5	4-5	4-5
BAYENTH001A	Enthalpy Control Kit <sup>(4)</sup>	2	✓	✓	✓
BAYEXMK001A	Extreme Conditions Mounting Kit		✓	✓	✓
BAYEXMK002B	Extreme Conditions Mounting Kit		✓	✓	✓
BAYEXMK003A	Extreme Conditions Mounting Kit (Used on Slab Mounts)		✓	✓	✓
BAYFLTR101C	1-2" Filter Frame-Requires one 20x25 filter. (not included) <sup>(2)</sup>	6	2-3	3	3
BAYFLTR201C	1-2" Filter Frame-Requires one 20x20, & one 20x18 filters. (not inc) <sup>(2)</sup>	6	3½-5	4-5	4-5
BAYLIFT002B	Lifting Lug Kit	5	✓	✓	✓
BAYLOAM105A	Low Ambient Control Kit	5	✓	✓	✓
BAYLOAM107A	Low Ambient Control Kit	5	✓	—	—
BAYRLAY004A	Economizer Relay <sup>(1)</sup>		✓	✓	✓
BAYOSAC001B	Outside Air Control for V.S. Economizer <sup>(16)</sup>		3-5	3-5	3-5
BAYOSAH001A	Manual Fresh Air Damper <sup>(2)</sup>	6	2-3	3	3
BAYOSAH002A	Manual Fresh Air Damper <sup>(2)</sup>	8	3½-5	4-5	4-5
BAYQSTK300A	Start Kit		✓	—	—
BAYSQRD001A	16" Round Duct Adapter <sup>(7)</sup>	5	2-3	3	3
BAYSQRD002A	18" Round Duct Adapter <sup>(7)</sup>	3	2-5	3-5	3-5
BAYUTIL101B	Roof Curb Extension Kit		2-3	3	3
BAYUTIL102B	Roof Curb Extension Kit		3½-5	4-5	4-5
BAYUV101A	21" Retrofit UVC Lamp Kit	5	2-3	3	3
BAYUV102A	33" Retrofit UVC Lamp Kit	5	3½-5	4-5	4-5

- ① Relay required with economizer on all heat pump applications.
- ② Must use filter frame when economizer/fresh air kit is used.
- ③ Ships knocked down.
- ④ Dry bulb control standard with economizer.
- ⑤ 2-Stage cooling control required when using economizer.
- ⑥ Do not use with electronic thermostats.
- ⑦ It is the responsibility of the installing dealer to properly size the ductwork for each specific application.
- ⑧ BAYCOVR112,118A will not cover BAYSQRD002A applications.
- ⑨ Does not contain barometric relief.
- ⑩ Max fresh air - 25%.
- ⑪ For non-continuous fan gas-heating applications, the damper opens only when the OD ambient is above 50° F.
- ⑫ It is the designer/engineer's responsibility to review product specifications prior to equipment selection to insure optimal performance and compliance to codes.
- ⑬ Temperature of mixed air entering the heat exchanger is monitored and fresh air intake may be reduced under certain conditions.
- ⑭ BAYACCDOR1A requires BAYFLTR101B & BAYACCDOR2A requires BAYFLTR201B. They are not backward compatible to BAYFLTR101/201A.
- ⑮ BAYOSAC001B is not compatible with BAYACCDOR1A or BAYACCDOR2A.

\*\* Single-phase units phasing out. No longer manufactured after 12-31-14.

EXISTING CURB	NEW UNIT 4WC**A	USE BAYADAP**A
BAYCURB030,38A	024-036	50
BAYCURB030,38A	042-060	52
BAYCURB033A	024-036	51
BAYCURB033A	024-060	53
BAYCURB034A	042-060	54

**For dimensional/outline drawings, please refer to Product Data.  
For information on Roof Curbs, please refer to the Accessories/Information Tab.**

For complete equipment / combination selections, installation instructions and warranty information, please refer to Product Data/Ratings and/or Installers Guides and Limited Warranty Handbooks.

# Packaged Heat Pump Over/Under 2-5 Tons

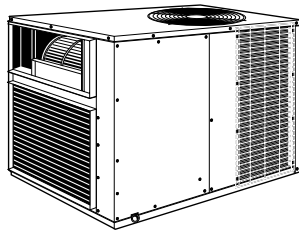

**4WHC4**

- **Duration®** compressor
- Over (supply) under (return) air
- Compressor internal overload protection
- Solenoid operated switchover valve
- Demand defrost control system
- Multi-speed direct drive blower motor
- High efficiency multi-speed ECM indoor motor on 4WHC4024-4036. 4WHC4042 models are variable speed.
- Weather resistant Powder Paint
- Copper tube, aluminum plate fin coils
- Top discharge condensing fan
- Factory installed wrap-around coil guard
- Top access to supplementary heater
- Pressure taps for refrigerant checks
- Polarized plug for easy field connection of low voltage to supplementary heaters
- Low ambient cooling to 55°F as manufactured
- Low ambient cooling to 0°F with accessory BAYLOAM011A
- All models are certified to UL 1995
- **10-year registered limited warranty on compressor, outdoor coil and all other functional parts (Residential Use)**
- **Optional extended warranties**

**Table PK-16-A — Silver 14 – Over/Under Horizontal Unit – R-410A**

Model No.	Dimensions		Shipping						
	Capacity	SEER/EER	HSPF	(in.) H x D x W		Weight (lbs.)	MCA*	Max Fuse*	Sound Rating
4WHC4024A1000A	24,800	16/13.6	8.2	31 x 44 x 32		322	18.7	25	74
4WHC4030A1000A	30,000	14/12	8	31 x 44 x 32		322	21.1	30	74
4WHC4036A1000A	35,800	14/12	8	31 x 44 x 32		322	26.2	40	75
4WHC4042A1000A	39,500	14/12	8	31 x 44 x 32		353	30.5	45	75
<b>Tons</b>	<b>Supply H x W</b>	<b>Return H x W</b>							
2 – 3½	8¾ x 27¾	16¾ x 27¾							

Dimensions are in inches. See Outline Dimensions.

\* Information subject to change. Please confirm with current Product Data/Service Facts for current factory production.

Compressor Types are: R1 = Reciprocating One Cylinder, R2 = Reciprocating Two Cylinder, S = Scroll

**Table PK-16-B— Supplementary Heaters – Heater Matrix**

Model No.①	Power Supply	kW Ratings	Used With	Shipping Weight
BAYHTRC106A	208/240/1/60	4.33/5.76 kW	4WHC4024-042	9
BAYHTRC109A	208/240/1/60	6.12/8.16 kW	4WHC4036-4042	10
BAYHTRC110A	208/240/1/60	7.93/10.56 kW	4WHC4030	10
BAYHTRC111A	208/240/1/60	7.98/10.56 kW	4WHC4024, 4036 & 4042	10
BAYHTRC117A	208/240/1/60	12.98/17.28 kW	4WHC4030-4042	23

**Table PH-16-C — Accessories/Comfort Controls**

Model No.	Description	Used With	Shipping Weight
BAYASCT001②③	Anti-Short Cycle Timer	All 4WHC4 Models	1
BAYECMT003A	Extreme Conditions Mounting Kit (Slab or Rack Mount)	All 4WHC4 Models	
BAYLOAM011A	Low Ambient Cooling Kit	All 4WHC4 Models	5
TAYASCT501A③	5 Minute Delay Relay	All 4WHC4 Models	2
TCONT402A	3Heat/2Clg (Heat Pump/A/C)	All 4WHC4 Models	1
TCONT602A	2Heat/2Clg (Heat Pump/A/C)	All 4WHC4 Models	1
TCONT802A	3Heat/2Clg (Heat Pump/A/C)	All 4WHC4 Models	1
TCONT803A	3Heat/2Clg (Heat Pump/A/C) w/Humidity Display	All 4WHC4 Models	1

① Heaters must have an "A" in eleventh digit to work on 4WHC4 models.

② Not for use with electronic thermostats.

③ Activated on Power Off.

**For dimensional/outline drawings, please refer to Product Data.  
For information on Roof Curbs, please refer to the Accessories/Information Tab.**

For complete equipment / combination selections, installation instructions and warranty information, please refer to Product Data/Ratings and/or Installers Guides and Limited Warranty Handbooks.

# Packaged Gas/Electric Convertible 2-5 Tons

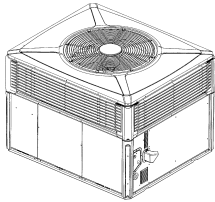

**4YCZ6**

**Table PK-17-A — 4YCZ6 - Platinum 16 - Convertible Packaged Gas/Electric - R-410A**

Model Number	Cooling Capacity (BTUH)	Heating Capacity Output (1 Stg./2 Stg.)	SEER	EER High/Low	AFUE(%)	Shipping Weight	MCA	Max Fuse	Sound Rating	Cabinet Dim. (in.) H x D x W
<b>4YCZ6 – 208-230/1/60</b>										
4YCZ6036C1070A	35,600	45,000/57,000	16.60	12.00/13.60	81.0	488	26.0	40	70	38 x 43 x 51
4YCZ6036C1090A	35,600	58,000/73,000	16.60	12.00/13.60	81.0	488	26.0	40	70	38 x 43 x 51
4YCZ6048C1090A	48,000	58,000/73,000	16.00	12.00/13.48	81.0	659	34.1	50	71	42 x 46 x 61
4YCZ6048C1115A	48,000	75,000/93,000	16.00	12.00/13.48	81.0	665	34.1	50	71	42 x 46 x 61
4YCZ6060C1115A	57,500	75,000/93,000	15.10	11.40/12.64	81.0	676	44.4	60	73	42 x 46 x 61
<b>4YCZ6 – 208-230/3/60</b>										
4YCZ6036A3075B	35,600	45,000/60,000	16.60	12.00/13.60	80.0	488	19.1	30	70	36 x 43 x 51
4YCZ6036A3096B	35,600	57,600/77,000	16.60	12.00/13.60	80.0	493	19.1	30	70	36 x 43 x 51
4YCZ6048A3096B	48,000	57,600/77,000	16.00	12.00/13.48	80.0	659	25.2	35	71	42 x 46 x 61
4YCZ6048A3120B	48,000	72,000/96,000	16.00	12.00/13.48	80.0	665	25.2	35	71	42 x 46 x 61
4YCZ6060A3120B	57,500	72,000/96,000	15.10	11.40/12.65	80.0	676	28.6	40	73	42 x 46 x 61
<b>4YCZ6 – 460/3/60</b>										
4YCZ6036A4075C	35,600	45,000/60,000	16.60	12.00/13.60	79.0	488	10.4	15	70	36 x 43 x 51
4YCZ6036A4096C	35,600	57,600/77,000	16.60	12.00/13.60	80.0	493	10.4	15	70	36 x 43 x 51
4YCZ6048A4096C	48,000	57,600/77,000	16.00	12.00/13.48	80.0	659	15.3	20	71	42 x 46 x 61
4YCZ6048A4120C	48,000	72,000/96,000	16.00	12.00/13.48	80.0	665	15.3	20	71	42 x 46 x 61
4YCZ6060A4120C	57,500	72,000/96,000	15.10	11.40/12.65	80.0	676	17.2	20	73	42 x 46 x 61

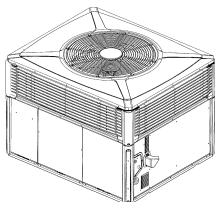

**4YCY4**

**Table PK-17-B — 4YCY4 - Gold 14 - Convertible Packaged Gas/Electric - R-410A**

Model Number	Cooling Capacity (BTUH)	Heating Capacity Output (1 Stg./2 Stg.)	SEER/EER	AFUE(%)	Shipping Weight	MCA	Max Fuse	Sound Rating	Cabinet Dimensions (in.) H x D x W
<b>4YCY4 – 208-230/1/60</b>									
4YCY4024C1060A	23,400	39,000/49,000	14.00/12.00	81.0	481	16.5	25	68	36 x 43 x 51
4YCY4030C1070A	30,000	45,000/57,000	14.00/12.00	81.0	481	19.2	30	71	36 x 43 x 51
4YCY4036C1070A	38,000	45,000/57,000	14.20/12.00	81.0	488	24.6	40	69	36 x 43 x 51
4YCY4036C1090A	38,000	58,000/73,000	14.20/12.00	81.0	488	24.6	40	69	36 x 43 x 51
4YCY4042C1090A	42,000	58,000/73,000	14.25/12.00	81.0	653	31.5	50	74	38 x 46 x 61
4YCY4048C1090A	48,500	58,000/73,000	14.20/12.00	81.0	669	35.4	50	73	38 x 46 x 61
4YCY4048C1115A	48,500	75,000/93,000	14.20/12.00	81.0	675	35.4	50	73	38 x 46 x 61
4YCY4060C1115A	58,500	75,000/93,000	14.00/12.00	81.0	676	43.3	60	76	42 x 46 x 61
<b>4YCY4 – 208-230/3/60</b>									
4YCY4036B3075A	38,000	45,000/60,000	14.20/12.00	80.0	488	19.8	30	69	36 x 43 x 51
4YCY4036B3096A	38,000	57,600/77,000	14.20/12.00	80.0	493	19.8	30	69	36 x 43 x 51
4YCY4048B3096A	48,000	57,600/77,000	14.20/11.90	80.0	653	26.4	40	73	38 x 46 x 61
4YCY4048B3120A	48,000	72,000/96,000	14.20/11.90	80.0	659	26.4	40	73	38 x 46 x 61
4YCY4060A3120B	58,500	72,000/96,000	14.00/12.00	80.0	676	30.6	45	76	42 x 46 x 61

**For dimensional/outline drawings, please refer to Product Data.  
For information on Roof Curbs, please refer to the Accessories/Information Tab.**



# Packaged Gas/Electric Convertible 2-5 Tons

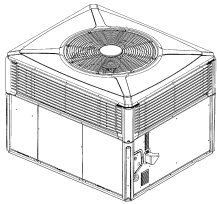

**4YCY5**

**Table PK-18-A — 4YCY5- Gold 15 - Convertible Packaged Gas/Electric - R-410A**

Model Number	Cooling Capacity (BTUH)	Heating Capacity Output (1 Stg./2 Stg.)	SEER/EER	AFUE(%)	Shipping Weight	MCA	Max Fuse	Sound Rating	Cabinet Dimensions (in.) H x D x W
<b>4YCY5- 208-230/1/60</b>									
4YCY5024A1060A	-	-	15.00/12.20	-	-	-	-	-	36 x 43 x 51
4YCY5030A1070A	-	-	15.00/12.20	-	-	-	-	-	36 x 43 x 51
4YCY5036A1070A	-	-	15.20/12.20	-	-	-	-	-	38 x 43 x 51
4YCY5036A1090A	-	-	15.20/12.20	-	-	-	-	-	38 x 43 x 51
4YCY5042A1090A	-	-	15.25/12.20	-	-	-	-	-	42 x 46 x 61
4YCY5048A1090A	-	-	15.20/12.20	-	-	-	-	-	42 x 46 x 61
4YCY5048A1115A	-	-	15.20/12.20	-	-	-	-	-	42 x 46 x 61
4YCY5060A1115A	-	-	15.00/11.40	-	-	-	-	-	42 x 46 x 61

**Table PK-18-B — Features**

	<b>4YCY5 2-5</b>	<b>4YCY4 2-5</b>	<b>4YCY5 2-5</b>
• SEER up to.....	16.60	14.25	15.00
• Exclusive <b>Duration™</b> high efficiency compressor with internal overload protection.....	✓	✓	✓
• Factory supplied charge.	R-410A	R-410A	R-410A
• Composite <b>Vortica®</b> indoor blower.....	✓	✓	✓
• High efficiency ECM indoor blower motor with <b>Comfort-R™</b> airflow system.....	✓	✓	✓
• All aluminum <b>Spine Fin™</b> outdoor coil.....	✓	✓	✓
• Swept-blade outdoor fan for quiet operation .....	✓	✓	✓
• Architecturally integrated louvers and corner guards.....	✓	✓	✓
• Polyslate gray cabinet.....	✓	✓	✓
• Stainless steel heat exchanger and burners .....	✓	✓	✓
• Single stage cool.....	—	✓	2-3½
• 2-stage cooling.....	✓	—	4,5
• 2-stage gas.....	✓	✓	✓
• Start kit - factory installed (single phase only).....	—	2, 2½	—
• High pressure cutout.....	✓	✓	✓
• Low pressure cutout.....	✓	✓	✓
• Liquid line drier - factory installed.....	✓	✓	✓
• Non-bleed expansion valves on indoor coil.....	✓	✓	✓
• Pressure taps, including liquid line taps, easily accessed and protected inside compressor compartment.....	✓	✓	✓
• Right side electrical service access for high and low voltage connections.....	✓	✓	✓
• Rugged steel basepan features deep drawn duct connections.....	✓	✓	✓
• Steeply sloped composite drainpan.....	✓	✓	✓
• Ships in horizontal configuration and converts quickly for downflow.....	✓	✓	✓
• Copper tube, aluminum fin indoor coil.....	✓	✓	3,4,5
• All aluminum indoor coil.....	—	—	2, 2½, 3½
• All models are certified to ANSI 221.47/CSA 2.3.....	✓	✓	✓
• <b>20-year heat exchanger, 12-year compressor, 10-year outdoor coil, &amp; 10-year all other functional parts registered limited warranty (Residential Use)①</b> .....	✓	—	—
• <b>20-year heat exchanger, 10-year compressor, 10-year outdoor coil, &amp; 10-year all other functional parts registered limited warranty (Residential Use)①</b> .....	—	✓	✓
• <b>Extended warranties available</b> .....	✓	✓	✓

① Registered Limited Warranty terms are available when you register within 60 days of installation. You can register online at americanstandardair.com or by phone at 800-554-8005; otherwise American Standard Heating & Air Conditioning's Base Limited Warranty terms will apply. Base Limited Warranty information on specific products can be found on ASDealerNet.com.

**For dimensional/outline drawings, please refer to Product Data.  
For information on Roof Curbs, please refer to the Accessories/Information Tab.**

# Packaged Gas/Electric Convertible 2-5 Tons

**Table PK-19-A — Accessories**

Model Number	Description	Shipping Weight	4YCZ6 3-5	4YCY4 2-5	4YCY5 2-5
BAYACCDOR1A	Hinged Filter Access Door <sup>②</sup>		3	2-3	2-3
BAYACCDOR2A	Hinged Filter Access Door <sup>②</sup>		3½-5	3½-5	3½-5
BAYADAP050A	Adapter Curb (Cabinet A/B)		3	2-3	2-3
BAYADAP051A	Adapter Curb (Cabinet C)		3	2-3	2-3
BAYADAP052A	Adapter Curb (Cabinet A/B)		4-5	3½-5	3½-5
BAYADAP053A	Adapter Curb (Cabinet C)		4-5	3½-5	3½-5
BAYADAP054A	Adapter Curb (Cabinet D)		4-5	3½-5	3½-5
BAYASCT001	Anti-Short Cycle Timer <sup>④</sup>		✓	✓	—
BAYCCHT101A	Crankcase Heater (230v) (Reciprocating)		—	2-2½	2-2½
BAYCCHT102A	Crankcase Heater (230v) (Scroll)		4-5	3½-5	3½-5
BAYCCHT103A	Crankcase Heater (230V) (Scroll)		3	3	2-3
BAYCCHT404B	Crankcase Heater (460v) (Scroll)		4-5	—	—
BAYCCHT405A	Crankcase Heater (460v) (Scroll)		3	—	—
BAYCOVR112A	12" Duct Shroud (Covers Horizontal Ducts) <sup>⑤</sup>		3-5	2-5	2-5
BAYCOVR118A	18" Duct Shroud (Covers Horizontal Ducts) <sup>⑤</sup>		3-5	2-5	2-5
BAYCURB050A	Flat Roof Full Perimeter Curb (Insulated)	.74	3	2-3	2-3
BAYCURB051A	Flat Roof Full Perimeter Curb (Insulated)	.74	4-5	3½-5	3½-5
BAYDMPR101A	Motorized Fresh Air Damper <sup>①⑦⑧⑨⑩</sup>		3	2-3	2-3
BAYDMPR102A	Motorized Fresh Air Damper <sup>①⑦⑧⑨⑩</sup>		4-5	3½-5	3½-5
BAYECON101A	Economizer with Barometric Relief (Downflow) <sup>①②③④⑩</sup>	.50	—	2-3	2-3
BAYECON102A	Economizer with Barometric Relief (Downflow) <sup>①②③④⑩</sup>	.65	—	3½-5	3½
BAYECON103A	Economizer with Barometric Relief (Downflow) <sup>①②③④⑩</sup>		3	—	—
BAYECON104A	Economizer with Barometric Relief (Downflow) <sup>①②③④⑩</sup>		4-5	—	4-5
BAYECON200A	Economizer (Horizontal) <sup>①②③⑦</sup>	.85	—	2-3	2-3
BAYECON201A	Economizer (Horizontal) <sup>①②③⑦</sup>	.85	—	3½-5	3½
BAYECON203A	Economizer (Horizontal) <sup>①②③⑦</sup>		3	—	—
BAYECON204A	Economizer (Horizontal) <sup>①②③⑦</sup>		4-5	—	4-5
BAYENTH001A	Enthalpy Control Kit <sup>②</sup>	.2	✓	✓	✓
BAYEXMK001A	Extreme Conditions Mounting Kit (Used on BAYCURB & BAYADAP)		✓	✓	✓
BAYEXMK002B	Extreme Conditions Mounting Kit (Used on BAYUTIL)		✓	✓	✓
BAYEXMK003A	Extreme Conditions Mounting Kit (Used on Slab Mounts)		✓	✓	✓
BAYFLTR101C	1-2" Filter Frame <sup>①</sup> -Requires one 20x25 filter (not included)	.6	3	2-3	2-3
BAYFLTR201C	1-2" Filter Frame <sup>①</sup> -Requires one 20x20, and one 20x18 filters (not included)	.6	4-5	3½-5	3½-5
BAYLIFT002B	Lifting Lug Kit	.5	✓	✓	✓
BAYLOAM105A	Low Ambient Control Kit	.5	✓	✓	✓
BAYLPKT100A	LP Conversion Kit		115k	115k	115k
BAYLPKT101A	LP Conversion Kit		60k, 90k	60K, 90K	60K, 90K
BAYLPKT102A	LP Conversion Kit		70k	70K	70K
BAYOSAC001B	Outside Air Control for V.S. Economizer <sup>⑧</sup>		3,4,5	—	4-5
BAYOSAH001A	Manual Fresh Air Damper <sup>①</sup>	.6	3	2-3	2-3
BAYOSAH002A	Manual Fresh Air Damper <sup>①</sup>	.8	4-5	3½-5	3½-5
BAYQSTK301A	Start Kit		—	✓	✓
BAYSQRD001A	16" Round Duct Adapter <sup>⑤</sup>	.5	3	2-3	2-3
BAYSQRD002A	18" Round Duct Adapter <sup>⑤</sup>	.3	4-5	2-5	2-5
BAYUTIL101B	Roof Curb Utility Extension Kit		3	2-3	2-3
BAYUTIL102B	Roof Curb Utility Extension Kit		4-5	3½-5	3½-5
BAYUV101A	21" Retrofit UVC Lamp Kit	.5	2-3	2-3	2-3
BAYUV102A	33" Retrofit UVC Lamp Kit	.5	3½-5	3½-5	3½-5

- ① Must use filter frame when economizer/fresh air kit is used.
- ② Dry bulb control standard with economizer.
- ③ 2-Stage cooling control required when using economizer.
- ④ Do not use with electronic thermostats.
- ⑤ It is the responsibility of the installing dealer to properly size the ductwork for each specific application.
- ⑥ BAYCOVR112,118A will not cover BAYSQRD002A applications.
- ⑦ Does not contain barometric relief.
- ⑧ Max fresh air - 25%.
- ⑨ For non-continuous fan gas-heating applications, the damper opens only when the OD ambient is above 50° F.
- ⑩ It is the designer/engineer's responsibility to review product specifications prior to equipment selection to insure optimal performance and compliance to codes.
- ⑪ Temperature of mixed air entering the heat exchanger is monitored and fresh air intake may be reduced under certain conditions.
- ⑫ BAYACCDOR1A requires BAYFLTR101B & BAYACCDOR2A requires BAYFLTR201B. They are not backward compatible to BAYFLTR101/201A.
- ⑬ BAYOSAC001B is not compatible with BAYACCDOR1A or BAYACCDOR2A

EXISTING CURB	NEW UNIT 4TC/WC/YC****A	USE BAYADAP0**A
BAYCURB030,38A	024-036	50
BAYCURB030,38A	042-060	52
BAYCURB033A	024-036	51
BAYCURB033A	042-060	53
BAYCURB034A	042-060	54

**For dimensional/outline drawings, please refer to Product Data.  
For information on Roof Curbs, please refer to the Accessories/Information Tab.**

For complete equipment / combination selections, installation instructions and warranty information, please refer to Product Data/Ratings and/or Installers Guides and Limited Warranty Handbooks.

# Packaged Gas/Electric Convertible 3-5 Tons

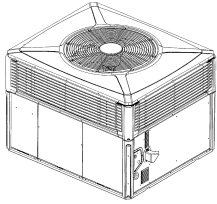

**4YCX3  
(3-Phase Only)**

**Table PK-20-A — 4YCX3 - Gold 13 - Convertible Packaged Gas/Electric - R-410A**

Model Number	Cooling Capacity (BTUH)	Heating Capacity Input/Output	SEER/EER	AFUE(%)	Shipping Weight	MCA	Max Fuse	Sound Rating	Cabinet Dimensions (in.) H x D x W
<b>4YCX3 – 208-230/3/60</b>									
4YCX3036A3064B	36,000	64,000/51,000	13.00/11.00	80.0	493	17.2	25	71	36 x 43 x 51
4YCX3036A3075B	36,000	75,000/60,000	13.00/11.00	80.0	488	17.2	25	71	36 x 43 x 51
4YCX3036A3096B	36,000	96,000/76,000	13.00/11.00	80.0	493	17.2	25	71	36 x 43 x 51
4YCX3048A3075B	46,500	75,000/61,000	13.00/11.00	80.0	645	24.0	35	73	38 x 46 x 61
4YCX3048A3096B	46,500	96,000/77,000	13.00/11.00	80.0	653	24.0	35	73	38 x 46 x 61
4YCX3048A3120B	46,500	120,000/95,000	13.00/11.00	80.0	659	24.0	35	73	38 x 46 x 61
4YCX3060A3096B	60,000	96,000/77,000	13.00/10.95	80.0	678	31.7	50	75	40 x 46 x 61
4YCX3060A3120B	60,000	120,000/95,000	13.00/10.95	80.0	684	28.6	40	75	40 x 46 x 61
<b>4YCX3 – 460/3/60</b>									
4YCX3036A4064B	36,000	64,000/51,000	13.00/11.00	80.0	448	9.5	15	71	36 x 43 x 51
4YCX3036A4075B	36,000	75,000/60,000	13.00/11.00	80.0	448	9.5	15	71	36 x 43 x 51
4YCX3036A4096B	36,000	96,000/76,000	13.00/11.00	80.0	493	9.5	15	71	36 x 43 x 51
4YCX3048A4075B	46,500	75,000/61,000	13.00/11.00	80.0	645	11.7	15	73	38 x 46 x 61
4YCX3048A4096B	46,500	96,000/77,000	13.00/11.00	80.0	653	11.7	15	73	38 x 46 x 61
4YCX3048A4120B	46,500	120,000/95,000	13.00/11.00	80.0	659	11.7	15	73	38 x 46 x 61
4YCX3060A4096A	60,000	96,000/77,000	13.00/10.95	80.0	678	19.5	25	75	40 x 46 x 61
4YCX3060A4120B	60,000	120,000/95,000	13.00/10.95	80.0	684	19.5	25	75	40 x 46 x 61

**For dimensional/outline drawings, please refer to Product Data.**

**For information on Roof Curbs, please refer to the Accessories/Information Tab.**

For complete equipment / combination selections, installation instructions and warranty information, please refer to Product Data/Ratings and/or Installers Guides and Limited Warranty Handbooks.

# Packaged Gas/Electric Convertible 2-5 Tons

**Table PK-21-A — 4YCC4 - Silver 14 - Convertible Packaged Gas/Electric - R-410A**

Model Number	Cooling Capacity (BTUH)	Heating Capacity Input/Output	SEER/EER	AFUE(%)	Shipping Weight	MCA	Max Fuse	Sound Rating	Cabinet Dimensions (in.) H x D x W
<b>4YCC4 – 208-230/1/60</b>									
4YCC4024A1060A	24,600	60,000/49,000	14.00/12.00	81.0	481	19.1	30	67	36 x 43 x 51
4YCC4030A1070A	28,200	70,000/57,000	14.00/12.00	81.0	481	22.6	35	69	36 x 43 x 51
4YCC4036A1070A	37,000	70,000/57,000	14.00/12.00	81.0	488	24.5	40	69	38 x 43 x 51
4YCC4036A1090A	37,000	90,000/73,000	14.00/12.00	81.0	493	24.5	40	69	38 x 43 x 51
4YCC4042A1060A	40,500	60,000/49,000	14.00/12.00	81.0	653	28.5	45	75	38 x 46 x 61
4YCC4042A1090A	40,500	90,000/73,000	14.00/12.00	81.0	653	28.5	45	75	38 x 46 x 61
4YCC4048A1070A	46,500	70,000/57,000	14.00/11.50	81.0	645	32.0	50	73	38 x 46 x 61
4YCC4048A1090A	46,500	90,000/73,000	14.00/11.50	81.0	653	32.0	50	73	38 x 46 x 61
4YCC4060A1090A	58,000	90,000/73,000	14.00/11.50	81.0	678	39.1	60	73	40 x 46 x 61
4YCC4060A1115A	58,000	115,000/93,000	14.00/11.50	81.0	684	39.1	60	73	40 x 46 x 61

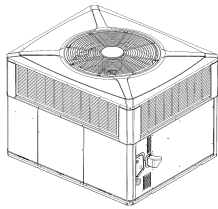

**4YCC4**

**Table PK-21-B — 4YCC3 - Silver 13 - Convertible Packaged Gas/Electric - R-410A**

Model Number	Cooling Capacity (BTUH)	Heating Capacity Input/Output	SEER/EER	AFUE(%)	Shipping Weight	MCA	Max Fuse	Sound Rating	Cabinet Dimensions (in.) H x D x W
<b>4YCC3 – 208-230/3/60</b>									
4YCC3036A3064B	35,000	64,000/51,000	13.00/11.00	80.0	488	17.2	25	75	36 x 43 x 51
4YCC3036A3075B	35,000	75,000/60,000	13.00/11.00	80.0	488	17.2	25	75	36 x 43 x 51
4YCC3036A3096B	35,000	96,000/76,000	13.00/11.00	80.0	493	17.2	25	75	36 x 43 x 51
4YCC3048A3075B	46,500	75,000/61,000	13.00/11.00	80.0	645	24.0	35	80	38 x 46 x 61
4YCC3048A3096B	46,500	96,000/77,000	13.00/11.00	80.0	653	24.0	35	80	38 x 46 x 61
4YCC3048A3120B	46,500	120,000/95,000	13.00/11.00	80.0	659	24.0	35	80	38 x 46 x 61
4YCC3060A3096B	58,000	96,000/77,000	13.00/10.95	80.0	678	31.5	50	79	40 x 46 x 61
4YCC3060A3120B	58,000	120,000/95,000	13.00/10.95	80.0	684	28.6	40	79	40 x 46 x 61
<b>4YCC3 – 460/3/60</b>									
4YCC3036A4064B	35,000	64,000/51,000	13.00/11.00	80.0	488	9.5	15	75	36 x 43 x 51
4YCC3036A4075B	35,000	75,000/60,000	13.00/11.00	80.0	488	9.5	15	75	36 x 43 x 51
4YCC3036A4096B	35,000	96,000/76,000	13.00/11.00	80.0	493	9.5	15	75	36 x 43 x 51
4YCC3048A4075B	46,500	75,000/61,000	13.00/11.00	80.0	645	11.7	15	80	38 x 46 x 61
4YCC3048A4096B	46,500	96,000/77,000	13.00/11.00	80.0	653	11.7	15	80	38 x 46 x 61
4YCC3048A4120B	46,500	120,000/95,000	13.00/11.00	80.0	659	11.7	15	80	38 x 46 x 61
4YCC3060A4096B	58,000	96,000/77,000	13.00/10.95	80.0	678	19.3	25	79	40 x 46 x 61
4YCC3060A4120B	58,000	120,000/95,000	13.00/10.95	80.0	684	19.3	25	79	40 x 46 x 61

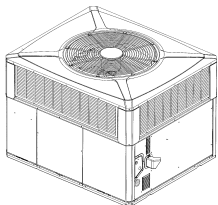

**4YCC3  
(3-Phase Only)**

**For dimensional/outline drawings, please refer to Product Data.  
For information on Roof Curbs, please refer to the Accessories/Information Tab.**

For complete equipment / combination selections, installation instructions and warranty information, please refer to Product Data/Ratings and/or Installers Guides and Limited Warranty Handbooks.

# Packaged Gas/Electric Convertible 2-5 Tons

**Table PK-22-A — Features**

	4YCC4 2-5	4YCX3 3-5	4YCC3 3-5
• SEER up to.....	14.00	13.00	13.00
• Exclusive <b>Duration™</b> high efficiency compressor with internal overload protection.....	✓	✓	✓
• Factory supplied charge.....	R-410A	R-410A	R-410A
• Composite <b>Vortica®</b> indoor blower.....	✓	✓	✓
• Direct drive multi-speed indoor blower motors.....	✓	✓	✓
• All aluminum <b>Spine Fin™</b> outdoor coil.....	✓	✓	✓
• Swept-blade outdoor fan for quiet operation.....	✓	✓	—
• Architecturally integrated louvers and corner guards.....	—	✓	—
• All steel louvers.....	✓	—	✓
• Polyslate gray cabinet.....	✓	✓	✓
• Stainless steel heat exchanger and burners.....	✓	✓	✓
• Single stage cool.....	✓	✓	✓
• Single stage gas.....	✓	✓	✓
• Start kit - factory installed (single phase only).....	✓	—	—
• High pressure cutout.....	✓	✓	✓
• Low pressure cutout.....	✓	✓	✓
• Liquid line drier - factory installed.....	✓	✓	✓
• Non-bleed expansion valves on indoor coil.....	✓	✓	✓
• Pressure taps, including liquid line taps, easily accessed and protected inside compressor compartment.....	✓	✓	✓
• Right side electrical service access for high and low voltage connections.....	✓	✓	✓
• Rugged steel basepan features deep drawn duct connections.....	✓	✓	✓
• Steeply sloped composite drainpan.....	✓	✓	✓
• Ships in horizontal configuration and converts quickly for downflow.....	✓	✓	✓
• Copper tube, aluminum fin indoor coil.....	5	✓	✓
• All Aluminum indoor coil.....	2 - 4	—	—
• All models are certified to ANSI 221.47/CSA 2.3.....	✓	✓	✓
• <b>20-year heat exchanger, 10-year compressor, 10-year outdoor coil, &amp; 10-year all other functional parts registered limited warranty (Residential Use)①.....</b>	✓	✓	—
• <b>10-year heat exchanger, 10-year compressor, 10-year outdoor coil, &amp; 10-year on all other functional parts registered limited warranty (Residential Use)①....</b>	—	—	✓
• <b>Extended warranties available.....</b>	✓	✓	✓

① Registered Limited Warranty terms are available when you register within 60 days of installation. You can register online at americanstandardair.com or by phone at 800-554-8005; otherwise American Standard Heating & Air Conditioning's Base Limited Warranty terms will apply. Base Limited Warranty information on specific products can be found on ASDealerNet.com.

**For dimensional/outline drawings, please refer to Product Data.  
For information on Roof Curbs, please refer to the Accessories/Information Tab.**

# Packaged Gas/Electric Convertible 2-5 Tons

**Table PK-23-A — Accessories**

Model Number	Description	Shipping Weight	4YCC4 2-5	4YCX3 3-5	4YCC3 3-5
BAYACCDOR1A	Hinged Filter Access Door <sup>⑫</sup>		2-3	3-3	3-3
BAYACCDOR2A	Hinged Filter Access Door <sup>⑫</sup>		3½-5	4-5	4-5
BAYADAP050A	Adapter Curb (Cabinet A/B)		2-3	3	3
BAYADAP051A	Adapter Curb (Cabinet C)		2-3	3	3
BAYADAP052A	Adapter Curb (Cabinet A/B)		3½-5	4-5	4-5
BAYADAP053A	Adapter Curb (Cabinet C)		3½-5	4-5	4-5
BAYADAP054A	Adapter Curb (Cabinet D)		3½-5	4-5	4-5
BAYASCT001	Anti-Short Cycle Timer <sup>④</sup>		✓	✓	✓
BAYCCHT102A	Crankcase Heater (230v) (Scroll)		3½-5	4-5	4-5
BAYCCHT103A	Crankcase Heater (230v) (Scroll)		2-3	3	3
BAYCCHT404B	Crankcase Heater (460v) (Scroll)		—	4-5	4-5
BAYCCHT405A	Crankcase Heater (460v) (Scroll)		—	3	3
BAYCOVR112A	12" Duct Shroud (Covers Horizontal Ducts) <sup>⑥</sup>		2-5	3-5	3-5
BAYCOVR118A	18" Duct Shroud (Covers Horizontal Ducts) <sup>⑥</sup>		2-5	3-5	3-5
BAYCURB050A	Flat Roof Full Perimeter Curb (Insulated)	74	2-3	3	3
BAYCURB051A	Flat Roof Full Perimeter Curb (Insulated)	74	3½-5	4-5	4-5
BAYDMPR101A	Motorized Fresh Air Damper <sup>①⑦⑧⑨⑩</sup>		2-3	3	3
BAYDMPR102A	Motorized Fresh Air Damper <sup>①⑦⑧⑨⑩</sup>		3½-5	4-5	4-5
BAYECON101A	Economizer with Barometric Relief (Downflow) <sup>①②③⑩⑪</sup>	50	2-3	3	3
BAYECON102A	Economizer with Barometric Relief (Downflow) <sup>①②③⑩⑪</sup>	65	3½-5	4-5	4-5
BAYECON200A	Economizer (Horizontal) <sup>①②③⑦</sup>	85	2-3	3	3
BAYECON201A	Economizer (Horizontal) <sup>①②③⑦</sup>	85	3½-5	4-5	4-5
BAYENTH001A	Enthalpy Control Kit <sup>②</sup>	2	✓	✓	✓
BAYEXMK001A	Extreme Conditions Mounting Kit (Used on BAYCURB & BAYADAP)		✓	✓	✓
BAYEXMK002B	Extreme Conditions Mounting Kit (Used on BAYUTIL)		✓	✓	✓
BAYEXMK003A	Extreme Conditions Mounting Kit (Used on Slab Mounts)		✓	✓	✓
BAYFLTR101C	1-2" Filter Frame <sup>①</sup> -Requires one 20x25 filter (not included)	6	2-3	3	3
BAYFLTR201C	1-2" Filter Frame <sup>①</sup> -Requires one 20x20, & one 20x18 filters (not incl)	6	3½-5	4-5	4-5
BAYLIFT002B	Lifting Lug Kit	5	✓	✓	✓
BAYLOAM105A	Low Ambient Control Kit	5	✓	✓	✓
BAYLOAM107A	Low Ambient Control Kit	5	✓	—	—
BAYLPKT100A	LP Conversion Kit		115k	115k	115k
BAYLPKT101A	LP Conversion Kit		60K, 90K	60K, 90K	60K, 90K
BAYLPKT102A	LP Conversion Kit		70K	70K	70K
BAYOSAH001A	Manual Fresh Air Damper <sup>①</sup>	6	2-3	3	3
BAYOSAH002A	Manual Fresh Air Damper <sup>①</sup>	8	3½-5	4-5	4-5
BAYQSTK301A	Start Kit		✓	✓	✓
BAYSQRD001A	16" Round Duct Adapter <sup>⑤</sup>	5	2-3	3	3
BAYSQRD002A	18" Round Duct Adapter <sup>⑤</sup>	3	2-5	3-5	3-5
BAYUTIL101B	Roof Curb Utility Extension Kit		2-3	3	3
BAYUTIL102B	Roof Curb Utility Extension Kit		3½-5	4-5	4-5
BAYUV101A	21" Retrofit UVC Lamp Kit	5	2-3	3	3
BAYUV102A	33" Retrofit UVC Lamp Kit	5	3½-5	4-5	4-5

- ① Must use filter frame when economizer/fresh air kit is used.
- ② Dry bulb control standard with economizer.
- ③ 2-Stage cooling control required when using economizer.
- ④ Do not use with electronic thermostats.
- ⑤ It is the responsibility of the installing dealer to properly size the ductwork for each specific application.
- ⑥ BAYCOVR112,118A will not cover BAYSQRD002A applications.
- ⑦ Does not contain barometric relief.
- ⑧ Max fresh air - 25%.
- ⑨ For non-continuous fan gas-heating applications, the damper opens only when the OD ambient is above 50° F.
- ⑩ It is the designer/engineer's responsibility to review product specifications prior to equipment selection to insure optimal performance and compliance to codes.
- ⑪ Temperature of mixed air entering the heat exchanger is monitored and fresh air intake may be reduced under certain conditions.
- ⑫ BAYACCDOR1A requires BAYFLTR101B & BAYACCDOR2A requires BAYFLTR201B. They are not backward compatible to BAYFLTR101/201A.

EXISTING CURB	NEW UNIT 4TC/WC/YC****A	USE BAYADAP0**A
BAYCURB030,38A	024-036	50
BAYCURB030,38A	042-060	52
BAYCURB033A	024-036	51
BAYCURB033A	042-060	53
BAYCURB034A	042-060	54

**For dimensional/outline drawings, please refer to Product Data.  
For information on Roof Curbs, please refer to the Accessories/Information Tab.**

# Single Power Entry Kits

## Packaged Convertible 2-5 Tons

	SINGLE POWER ENTRY KIT	HEATER	4TCC4	4TCY4	4TCY5	4WCC4	4WCY4	4WCY5	4WCZ6			
SINGLE PHASE (208/240v)	BAYSPEK060	BAYHTRV105	2-4	2-5	TBD	2-3	2-3	TBD	3			
		BAYHTRV108	2-4	2-5		2	2		—			
		BAYHTRV110	2-4	2-3		—	—		—			
	BAYSPEK062	BAYHTRV105	5	—		3½-5	3½-5		4-5			
		BAYHTRV108	5	—		2½-5	2½-5		3-5			
		BAYHTRV110	5	3½-5		2-5	2-5		3-5			
	BAYSPEK063	BAYHTRV115	2½-5	2½-5		2½-5	2½-5		3-5			
		BAYHTRV120	4-5	3½-5		3½-5	3½-5		4-5			
		SINGLE POWER ENTRY KIT	HEATER	4TCC3		4TCX3	4TCY4		4WCC3	4WCX3	4WCY4	4WCZ6
3 PHASE (208/240v)	BAYSPEK064	BAYHTRV315	—	—	—	3-5	3-5	3-5	3-5			
		BAYHTRV320	4-5	4-5	4-5	4-5	4-5	4-5	4-5			
	BAYSPEK065	BAYHTRV310	—	—	—	5	5	5	5			
	BAYSPEK061	BAYHTRV305	3-5	3-5	3-5	3-5	3-5	3-5	3-5			
		BAYHTRV308	3-5	3-5	3-5	3-5	3-5	3-5	3-5			
		BAYHTRV310	3-5	3-5	3-5	3-4	3-4	3-4	3-4			
		BAYHTRV315	3-5	3-5	3-5	—	—	—	—			
3 PHASE (460v)	BAYSPEK061	BAYHTRV405	3-5	3-5	—	3-5	3-5	—	3-5			
		BAYHTRV408	3-5	3-5	—	3-5	3-5	—	3-5			
		BAYHTRV410	3-5	3-5	—	3-5	3-5	—	3-5			
		BAYHTRV415	3-5	3-5	—	3-5	3-5	—	3-5			
		BAYHTRV420	4-5	4-5	—	4-5	4-5	—	4-5			

**For dimensional/outline drawings, please refer to Product Data.**

**For information on Roof Curbs, please refer to the Accessories/Information Tab.**

# Supplemental Heater Table Packaged Convertible 2-5 Tons

	BAYHTRV105 3.76/5.0 kW	BAYHTRV108 6.0/8.0 kW	BAYHTRV110 7.50/10.0 kW	BAYHTRV115 11.27/15.0 kW	BAYHTRV120 15.00/20.0 kW	BAYHTRV125 18.78/25.0 kW
4TCY5024A1	<b>TBD</b>					
4TCY5030A1						
4TCY5036A1						
4TCY5042A1						
4TCY5048A1						
4TCY5060A1						
4TCY4024A1	Y	Y	Y	--	--	--
4TCY4030A1	Y	Y	Y	Y	--	--
4TCY4036B1	Y	Y	Y	Y	--	--
4TCY4042B1	Y	Y	Y	Y	Y	Y
4TCY4048B1	Y	Y	Y	Y	Y	Y
4TCY4060A1	Y	Y	Y	Y	Y	Y
4TCC4024A1	Y	Y	Y	--	--	--
4TCC4030A1	Y	Y	Y	Y	--	--
4TCC4036A1	Y	Y	Y	Y	--	--
4TCC4042A1	Y	Y	Y	Y	--	--
4TCC4048A1	Y	Y	Y	Y	Y	--
4TCC4060A1	Y	Y	Y	Y	Y	Y
4WCZ6042B1	Y	Y	Y	Y	--	--
4WCZ6048B1	Y	Y	Y	Y	Y	Y
4WCZ6060B1	Y	Y	Y	Y	Y	Y
4WCY5024A1	<b>TBD</b>					
4WCY5030A1						
4WCY5036A1						
4WCY5042A1						
4WCY5048A1						
4WCY5060A1						
4WCY4024A1	Y	Y	Y	--	--	--
4WCY4030A1	Y	Y	Y	Y	--	--
4WCY4036C1	Y	Y	Y	Y	--	--
4WCY4042B1	Y	Y	Y	Y	Y	--
4WCY4048B1	Y	Y	Y	Y	Y	--
4WCY4060B1	Y	Y	Y	Y	Y	Y
4WCC4024A1	Y	Y	Y	--	--	--
4WCC4030A1	Y	Y	Y	Y	--	--
4WCC4036A1	Y	Y	Y	Y	--	--
4WCC4042A1	Y	Y	Y	Y	--	--
4WCC4048A1	Y	Y	Y	Y	Y	--
4WCC4060A1	Y	Y	Y	Y	Y	Y

**For dimensional/outline drawings, please refer to Product Data.  
For information on Roof Curbs, please refer to the Accessories/Information Tab.**

For complete equipment / combination selections, installation instructions and warranty information, please refer to Product Data/Ratings and/or Installers Guides and Limited Warranty Handbooks.





# Supplemental Heater Table

## Packaged Convertible 2-5 Tons

	BAYHTRV305 3.76/5.0 kW (3PH)	BAYHTRV308 6.0/8.0 kW (3PH)	BAYHTRV310 7.50/10.0 kW (1PH)	BAYHTRV315 11.27/15.0 kW (3PH)	BAYHTRV320 15.0/20.0 kW (3PH)	BAYHTRV325 18.78/25.0 kW (3PH)
4TCY4036B3	Y	Y	Y	Y	--	--
4TCY4048B3	Y	Y	Y	Y	Y	Y
4TCY4060B3	Y	Y	Y	Y	Y	Y
4TCX3036A3	Y	Y	Y	Y	--	--
4TCX3048A3	Y	Y	Y	Y	Y	--
4TCX3060A3	Y	Y	Y	Y	Y	Y
4TCC3036A3	Y	Y	Y	Y	--	--
4TCC3048A3	Y	Y	Y	Y	Y	--
4TCC3060A3	Y	Y	Y	Y	Y	Y
4WCZ6036B3	Y	Y	Y	Y	--	--
4WCZ6048B3	Y	Y	Y	Y	Y	Y
4WCZ6060B3	Y	Y	Y	Y	Y	Y
4WCY4036A3	Y	Y	Y	Y	--	--
4WCY4048A3	Y	Y	Y	Y	Y	--
4WCY4060B3	Y	Y	Y	Y	Y	--
4WCX3036A3	Y	Y	Y	Y	--	--
4WCX3048A3	Y	Y	Y	Y	Y	--
4WCX3060A3	Y	Y	Y	Y	Y	Y
4WCC3036A3	Y	Y	Y	Y	--	--
4WCC3048A3	Y	Y	Y	Y	Y	--
4WCC3060A3	Y	Y	Y	Y	Y	Y
	BAYHTRV405 5.0 kW (3PH)	BAYHTRV408 8.0 kW (480V 3 PH)	BAYHTRV410 10.0 kW (3PH)	BAYHTRV415 15.0 kW (480V 3 PH)	BAYHTRV420 20.0 kW (480V 3 PH)	BAYHTRV425 25.0 kW (480V 3 PH)
4TCX3036A4	Y	Y	Y	Y	--	--
4TCX3048A4	Y	Y	Y	Y	Y	--
4TCX3060A4	Y	Y	Y	Y	Y	Y
4TCC3036A4	Y	Y	Y	Y	--	--
4TCC3048A4	Y	Y	Y	Y	Y	--
4TCC3060A4	Y	Y	Y	Y	Y	Y
4WCZ6036B4	Y	Y	Y	Y	--	--
4WCZ6048B4	Y	Y	Y	Y	Y	--
4WCZ6060B4	Y	Y	Y	Y	Y	--
4WCX3036A4	Y	Y	Y	Y	--	--
4WCX3048A4	Y	Y	Y	Y	Y	--
4WCX3060A4	Y	Y	Y	Y	Y	Y
4WCC3036A4	Y	Y	Y	Y	--	--
4WCC3048A4	Y	Y	Y	Y	Y	--
4WCC3060A4	Y	Y	Y	Y	Y	Y

**For dimensional/outline drawings, please refer to Product Data.**  
**For information on Roof Curbs, please refer to the Accessories/Information Tab.**

For complete equipment / combination selections, installation instructions and warranty information, please refer to Product Data/Ratings and/or Installers Guides and Limited Warranty Handbooks.

# Variable Speed Packaged Units

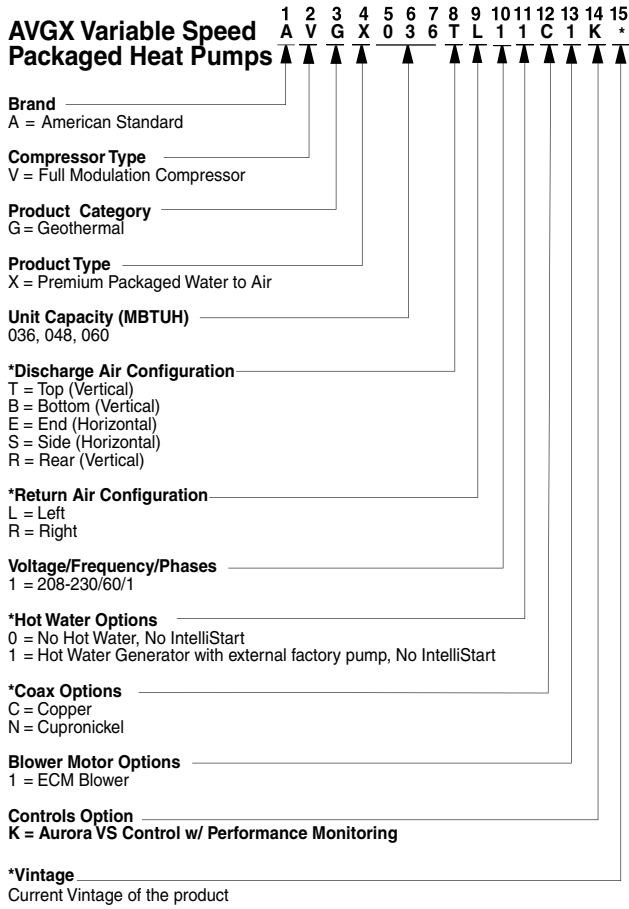

**Capacities**  
Variable Capacities = 036, 048, 060

\*Select desired options to create specific model number.

Geothermal

## Variable Speed Packaged Units

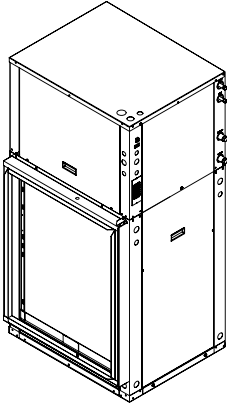

- Extended range operation (20-120°F EWT)
  - Earth friendly R-410A refrigerant
  - Aurora advanced variable speed control
  - "Superboost" cooling mode
  - Duration™ Variable Speed Compressor
  - Variable Speed ECM fan motor
  - FormiShield Plus™ coated air coil
  - Electronic expansion valve
  - Internal electric heat (optional on vertical units only)
  - 1" Swivel fittings
  - Gray powder coated heavy guage galvanized cabinet
  - Factory computer run test
  - ARI/ASHRAE/ISO 13256-1 performance certified and UL/ETL safety listed
  - 2" Filter Rack with MERV 11 filter Included
  - Horizontal Hanger Kit included for horizontal configurations
  - **10-year parts and 5-year labor allowance**
- \* Unit includes:**  
Refrigerant Monitoring Module  
Performance Monitoring Module  
Energy Monitoring Module
- \* Requires AID Tool**

**Table GEO-2-A — VGX - Variable Speed Water Source Heat Pumps**

Unit Model No.	Power Supply Volts/Hz/Phase	Nominal Cooling Capacity (Btuh)		Dimensions (in.) <sup>Ⓛ</sup> H x W x L	Shipping Weight (lbs.)	Nominal Supply Opening (WxD) <sup>Ⓛ</sup>	Nominal Return Opening (DxH) <sup>Ⓛ</sup>	Filter Size <sup>Ⓛ</sup>	Water Inlet/Outlet Size	Min Circ Amp ECM 2 Motor	Max Fuse
		ECM 2 Motor	ECM 2 Motor								
AVGX036	208-230/60/1	38,000	38,000	26x32x55	372	18x18	28x30	32x30	1" Swivel	37.3	40
AVGX048	208-230/60/1	49,000	49,000	26x32x55	381	18x18	28x30	32x30	1" Swivel	47.8	50
AVGX060	208-230/60/1	60,000	60,000	26x32x59	405	18x18	28x34	36x30	1" Swivel	54.1	60

<sup>Ⓛ</sup> Vertical Applications.

\* For models not listed and unit details, please refer to the Geothermal/Water Source Heat Pump Product Data publication.

**Models listed are representative ONLY. Please refer to model nomenclature for product line configuration.**

# Variable Speed Packaged Units

**Table GEO-3-A — Optional Accessories for VGX Units \***

Model Number	Description
<b>Thermostats</b>	
TPCC32U01E	Communicating Color Touchscreen Thermostat w/Energy Monitoring and Humidity Control
TPCM32U04E	Communicating Thermostat with Energy Monitoring capabilities and Humidity Control
<b>Notes: Must use TPCC32U01, TPCM32U04 or IntelliZone2 - No other thermostats will operate the heat pump.</b>	
<b>Diagnostic Tool</b>	
AIDK01	Aurora Interface Display Service Tool
<b>Variable Speed Flow Center</b>	
FCV1-GL	High impact polystyrene plastic cabinet, one Grundfos Magna Geo 32-140 variable speed pump (1 pump flow center) and one UP26-99 fixed speed pump (2nd pump on 2 pump flow center)
<b>IntelliZone2 with MasterStat and AXB Communication Harness</b>	
IntelliZone 2TA	Communicating Zone System (Only works with XV Series Units)
	Multiple level zone calls communicate exact zone load requirements
	Controls up to 6 zones with Variable Speed units, 4 zones with dual capacity compressor (2 w/ single-speed compressor)
	Direct control of Variable speed ECM fan motor to match needs of the space. 6-8 fan speeds on line, up to 12 speeds available
	Zone sizes as small as 25% of whole house (15% Variable Speed and 25% Dual Capacity)
	Individual zone selectable economy or comfort mode
	Four upstaging options: normal, quicker, faster or faster w/ timer for various application scenarios
	Dehumidification mode lowers airflow in cooling for better dehumidification
	Power consumption displayed on MasterStat for all XV Series with advanced controls
<b>Zone Thermostat</b>	
ZoneStat	Option for any of Zones 2 through 6. Full setback capability with communication to the IntelliZone2 System
<b>Zone Sensor Thermostat</b>	
SensorStat	Option for any of Zones 2 through 6. Full setback capability (through the MasterStat only) with communication to the IntelliZone2 System
<b>Trouble Shooting Kit</b>	
Z2TK	Back plate of the MasterStat w/ harness to plug into IntelliZone2 relay board for set up and service at the zone panel
ZTK240	Zone Transformer Kit - 208/240V - 24V

\*Note: These accessories are dedicated for Variable Speed \*VGX units ONLY

**Table GEO-3-B — Optional Accessories for VGX Units (Non-Dedicated)**

Model Number	Description
<b>Vertical Auxilliary Heaters</b>	
EAL10A	Internal mount, electronic control board, sequenced operation, - 15-20kW Include internal fuses
EAL15A	Internal mount, electronic control board, sequenced operation, - 15-20kW Include internal fuses
EAL20A	Internal mount, electronic control board, sequenced operation, - 15-20kW Include internal fuses
<b>Horizontal Auxilliary Heaters</b>	
EALH10A	Internal mount control box, coil assembly external mount, electronic control board, sequenced operation, 15-20KW include internal fuses
EALH15A	Internal mount control box, coil assembly external mount, electronic control board, sequenced operation, 15-20KW include internal fuses
EALH20A	Internal mount control box, coil assembly external mount, electronic control board, sequenced operation, 15-20KW include internal fuses
<b>Air Pads for Vertical Topflow Units</b>	
AP32	AP = High Density Plastic
APF2634	APF = 2" PEX foam, cutable
<b>Electronic Air Cleaner</b>	
EAC3032	Vertical Units (30x32)
EAC3036	Vertical Units (30x36)
EAC3036	Bottom Flow Units (30x36)
EAC2042	Horizontal Units (20x42)
EAC2047	Horizontal Units (20x47)

# Water to Air Packaged Units

Geothermal

## 1GX - 2GX Water Source Heat Pumps

1 2 3 4 5 6 7 8 9 10 11 12 13 14 15  
A 1 G X 0 2 2 T R R 1 0 C 0 H

**Brand** \_\_\_\_\_  
A = American Standard

**\*Compressor Type** \_\_\_\_\_  
1 = Single Speed  
2 = Dual Capacity

**Product Category** \_\_\_\_\_  
G = Geothermal

**Product Type** \_\_\_\_\_  
X = Premium Packaged System (Water-to-Air)

**Nominal BTU's** \_\_\_\_\_  
Thousands of BTU's

**\*Discharge Air Configuration** \_\_\_\_\_  
T = Top (Vertical)  
B = Bottom (Vertical 022-072)  
E = End (Horizontal)  
S = Side (Horizontal)  
R = Rear (Vertical 042-072 Only)

**\*Return Air Configuration** \_\_\_\_\_  
L = Left  
R = Right

**Heating and/or Cooling** \_\_\_\_\_  
R = Heating and Cooling (Reversible)

**Voltage/Frequency/Phases** \_\_\_\_\_  
1 = 208-230/60/1

**\*Hot Water Options** \_\_\_\_\_  
0 = No Hot Water, No IntelliStart  
1 = Hot Water Generator with factory installed pump, No IntelliStart  
3 = No Hot Water, IntelliStart  
4 = Hot Water Generator with factory installed pump, IntelliStart

**\*Coax Options** \_\_\_\_\_  
C = Copper Uncoated Aluminum Coil  
N = Cupronickel Uncoated Aluminum Coil

**\*Blower Motor Options** \_\_\_\_\_  
0 = PSC  
1 = Variable Speed ECM Blower (018-072)  
2 = High Static Variable Speed ECM Blower (036-049)  
4 = 5-Speed ECM (022-072)

**\*Vintage** \_\_\_\_\_  
H=Internal Factory Use Only

**Capacities**  
Single = 022, 030, 036, 042, 048, 060, 070  
Dual = 26, 038, 049, 064, 072

\*Select desired options to create specific model number.  
Note: All models have sound kits.

## 2GC Water Source Heat Pumps

1 2 3 4 5 6 7 8 9 10 11 12 13 14 15  
A 2 G C 0 4 8 T L R 1 0 C 4 \*

**Brand** \_\_\_\_\_  
A = American Standard

**Compressor Type** \_\_\_\_\_  
2 = Dual Capacity

**Product Category** \_\_\_\_\_  
G = Geothermal

**Product Type** \_\_\_\_\_  
C = Mid-Level Packaged System

**Unit Capacity** \_\_\_\_\_  
024, 036, 048, 060, 072

**Discharge Air Configuration** \_\_\_\_\_  
T = Top (Vertical)  
E = End (Horizontal)  
S = Side (Horizontal)

**Return Air Configuration** \_\_\_\_\_  
L = Left  
R = Right

**Heating and/or Cooling** \_\_\_\_\_  
R = Heating and Cooling (Reversible)

**Voltage/Frequency/Phases** \_\_\_\_\_  
1 = 208-230/60/1

**Hot Water Options** \_\_\_\_\_  
0 = No HWG, No IntelliStart  
1 = HWG with Factory Installed Pump, No IntelliStart  
3 = No HWG, IntelliStart  
4 = HWG with Factory Installed Pump, IntelliStart

**Water, Coax & Air Coil Options** \_\_\_\_\_  
C = Copper, Uncoated Air Coil  
N = Cupronickel, Uncoated Air Coil

**Blower Motor Options** \_\_\_\_\_  
4 = 5-Speed ECM, Duct Flanges, No Filter  
0 = 5-Speed ECM, 1" Filter Rack with 1" MERV8

**Vintage** \_\_\_\_\_  
\*Current Vintage of the Product

## Water to Air Packaged Units

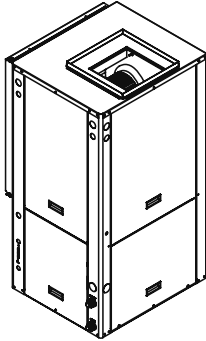

- Extended range operation (20-120°F EWT)
- Earth friendly R-410A refrigerant
- Premier 2 microprocessor based controls with fault indicator lights
- Duration™ single speed or dual capacity scroll compressor
- PSC Motor or ECM variable speed fan motor
- Internal expansion valve
- Optional internal electric heat
- 1" Swivel fittings
- Special gray color powder coated heavy gauge galvanized cabinet
- Factory computer run test
- ARI/ASHRAE/ISO 13256-1 performance certified and UL/ETL safety listed
- 2" Filter Rack with MERV 11 filter Included
- Horizontal Hanger Kit Included
- **10-year parts and 5-year labor allowance**

**Table GEO-5-A — 1GX - 2GX Water Source Heat Pumps**

Unit Model No.	Power Supply Volts/Hz/Phase	Normal Cooling Capacity (Btuh) ECM 2 Motor	Dimensions (in.) <sup>①</sup> H x W x L	Shipping Weight (lbs.)	Nominal Supply Opening (WxD) <sup>①</sup>	Nominal Return Opening (DxH) <sup>①</sup>	Filter Size <sup>①</sup>	Water Inlet/Outlet Size	Min Circ Amp ECM 2 Motor	Max Fuse
A1GX022	208-230/60/1	21,700	48.4x22.3x26.3	313	14x14	22x26	28x24	1" Swivel	15.2	20
A2GX026	208-230/60/1	27,200	48.4x22.3x26.3	313	14x14	22x26	28x24	1" Swivel	16.8	25
A1GX030	208-230/60/1	29,400	48.4x22.3x26.3	328	14x14	22x26	28x24	1" Swivel	20.0	30
A1GX036	208-230/60/1	35,000	50.4x25.4x31.4	373	18x18	28x26	28x30	1" Swivel	21.6	35
A2GX038	208-230/60/1	40,200	50.4x25.4x31.4	378	18x18	28x26	28x30	1" Swivel	24.8	40
A1GX042	208-230/60/1	42,000	54.4x25.4x31.4	388	18x18	28x30	32x30	1" Swivel	24.8	40
A1GX048	208-230/60/1	49,300	54.4x25.4x31.4	428	18x18	28x30	32x30	1" Swivel	28.8	45
A2GX049	208-230/60/1	50,000	54.4x25.4x31.4	428	18x18	28x30	32x30	1" Swivel	30.4	50
A1GX060	208-230/60/1	66,800	58.4x25.4x31.4	463	18x18	28x34	36x30	1" Swivel	40.0	60
A2GX064	208-230/60/1	67,600	58.4x25.4x31.4	473	18x18	28x34	36x30	1" Swivel	39.0	60
A1GX070	208-230/60/1	73,200	58.4x25.4x31.4	488	18x18	28x34	36x30	1" Swivel	44.6	70
A2GX072	208-230/60/1	73,600	58.4x25.4x31.4	488	18x18	28x34	36x30	1" Swivel	41.0	60

<sup>①</sup> Vertical Applications.

\* For models not listed and unit details, please refer to the Geothermal/Water Source Heat Pump Product Data publication.

**Models listed are representative ONLY. Please refer to model nomenclature for product line configuration.**

# Water to Air Packaged Units

**Table GEO-6-A — Optional Accessories 1GX - 2GX**

Model Number	Description	Used With	
		Single Speed Models	Dual Capacity Models
<b>Vertical Auxiliary Heaters</b>			
EAS4A		012	
EAM5A	①	022, 030	026
EAM8A	①	030	026
EAM10A	①	030	026
EAL10A	①	036, 042, 048, 060, 070	038, 049, 064, 072
EAL15A	①	036, 042, 048, 060, 070	038, 049, 064, 072
EAL20A	①	048, 060, 070	049, 064, 072
<b>Horizontal Auxiliary Heaters</b>			
EASH4A		012	
EAMH5A	②	022,030	026
EAMH8A	②	022,030	026
EAMH10A	②	030	026
EALH10A	②	036, 042, 048, 060, 070	038, 049, 064, 072
EALH15A	②	036, 042, 048, 060, 070	038, 049, 064, 072
EALH20A	②	048, 060, 070	049, 064, 072
<b>Air Pads for Vertical Topflow Units</b>			
AP2430	AP= High density plastic	022, 030	026
AP32	AP= High density plastic	036, 042, 048, 060, 070	038, 049, 064, 072
APF2634	APF= 2" PEX foam, cutable	022, 030, 036, 042, 048, 060, 070	026, 038, 049, 064, 072
<b>Thermostats (All Controls- 3H, 2C, Dual Fuel Compatible)</b>			
AZONE950AC52ZA	950 Premium Control (Requires Relay Panel)		
BAY24VRPAC52DA	24 Volt Interface Relay Panel for 950 Control		
ACONT802AS32DA	Programmable Touch Screen Digital Control		
ACONT803AS32DA	Programmable Touch Screen Digital Control with Dehumidification Control		
ACONT402AN32DA	Non-Programmable Comfort Control		
<b>Disposable Pleated Filters, 2" MERV11③</b>			
59P509-04	Vertical Units (24x28)④	022, 030	026
59P509-08	Vertical Units (28x30)	036	038
59P509-07	Vertical Units (30x32)	042, 048	049
59P509-06	Vertical Units (30x36)⑤	060, 070	064, 072
59P509-09	Horizontal Units (18x32)	022, 030	026
59P509-10	Horizontal Units (20x37)	036	049
59P509-02	Horizontal Units (20x20)	042, 048	049
59P509-11	Horizontal Units (20x22)	042, 048, 060, 070	049, 064, 072
59P509-03	Horizontal Units (20x25)	060, 070	064, 072

① Internal Mount, Electronic Control Board, Sequenced Operation, 15-20kW include internal fuses.

② Internal mount control box, coil assembly external mount, Electronic Control Board, Sequenced Operation, 15-20kW include internal fuses (Use on Horizontal & Rear Discharge Units).

③ 6 month life (Minimum order qty. 2).

④ Bottom flow 22-30

⑤ Bottom flow 36-72

## Water to Air Packaged Units Mid-Efficiency

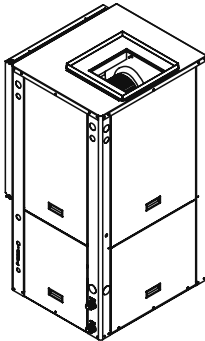

- Extended range operation (20-120°F EWT)
- Earth friendly R-410A refrigerant
- Premier 2 microprocessor based controls with fault indicator lights
- Duration™ single speed or dual capacity scroll compressor
- 5-Speed ECM fan motor
- Aluminum air coil
- Optional internal electric heat
- 1" Swivel fittings
- Special gray color powder coated heavy gauge galvanized cabinet
- Factory computer run test
- ARI/ASHRAE/ISO 13256-1 performance certified and UL/ETL safety listed
- **Standard 2 Year Parts and Labor & 5 Year Refrigeration Component and Labor Warranty**
- **5 Year Parts and Labor Allowance Warranty (OPTIONAL)**

**Table GEO-7-A — 2GC Water Source Heat Pumps - Vertical Application**

Unit Model No.	Power Supply Volts/Hz/Phase	Normal Cooling Capacity (Btuh) ECM 2 Motor	Dimensions (in.) <sup>①</sup> H x W x L	Shipping Weight (lbs.)	Nominal Supply Opening (WxD) <sup>①</sup>	Nominal Return Opening (DxH) <sup>①</sup>	Filter Size <sup>①</sup>	Water Inlet/Outlet Size	Min Circ Amp ECM 2 Motor	Max Fuse
A2GC024	208-230/60/1	23,100	39.4x22.5x26.5	218	14x14	22x18	20x24	1" Swivel	24.5	35
A2GC036	208-230/60/1	35,100	44.5x22.5x26.5	244	14x14	22x22	20x24	1" Swivel	28.9	40
A2GC048	208-230/60/1	49,000	50.4x25.6x31.6	323	18x18	28x26	28x30	1" Swivel	39.8	60
A2GC060	208-230/60/1	59,900	50.4x25.6x31.6	349	18x18	28x26	28x30	1" Swivel	47.2	70
A2GC072	208-230/60/1	67,000	54.4x25.6x31.6	370	18x18	28x30	30x32	1" Swivel	50.4	80

<sup>①</sup> Vertical Applications.

\* For models not listed and unit details, please refer to the Geothermal/Water Source Heat Pump Product Data publication.

## Water to Air Packaged Units Mid-Efficiency

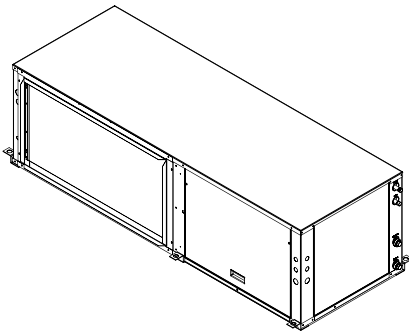

- Side or end discharge for horizontal units
- Left or right return locations
- Cabinet design - improved access panels and narrow profile

**Table GEO-7-B — 2GC Water Source Heat Pumps - Horizontal Application**

Unit Model No.	Power Supply Volts/Hz/Phase	Normal Cooling Capacity (Btuh) ECM 2 Motor	Dimensions (in.) <sup>②</sup> W x D x H	Shipping Weight (lbs.)	Nominal Supply Opening (HxD) <sup>②</sup>	Nominal Return Opening (DxH) <sup>②</sup>	Filter Size <sup>②</sup>	Water Inlet/Outlet Size	Min Circ Amp ECM 2 Motor	Max Fuse
A2GC024	208-230/60/1	23,100	22.5x53.0x19.3	248	10.5x9.5	21.8x16.5	18x24	1" Swivel	24.5	35
A2GC036	208-230/60/1	35,100	22.5x63.0x19.3	270	10.5x9.5	30.5x16.7	20x32	1" Swivel	28.9	40
A2GC048	208-230/60/1	49,000	25.6x72.0x21.3	345	13.6x13.2	35.5x18.6	20x37	1" Swivel	39.8	60
A2GC060	208-230/60/1	59,900	25.6x72.0x21.3	378	13.6x13.2	35.5x18.6	20x37	1" Swivel	47.2	70
A2GC072	208-230/60/1	67,000	25.6x77.0x21.3	389	13.6x13.2	40.4x18.7	<sup>③</sup>	1" Swivel	50.4	80

<sup>②</sup> Horizontal Applications.

<sup>③</sup> A2GC072 Horizontal application requires a 20x20 filter and a 20x22 filter.

\* For models not listed and unit details, please refer to the Geothermal/Water Source Heat Pump Product Data publication.



# Water to Air Packaged Units Mid-Efficiency

**Table GEO-8-A — Optional Accessories 2GC**

Model Number	Description	Dual Capacity Models	Used With
<b>Air Pads for Vertical Units</b>			
AP2430	AP High Density Plastic	026	
AP32	AP High Density Plastic	038,049,064,072	
APF2634	AOF - 2" PEX Foam, Cuttable	026,038,049,064,072	
<b>Vertical Auxilliary Heaters</b>			
EAM5A	①	026,038	
EAM8A	①	026,038	
EAM10A	①	026,038	
EAL10A	①	049,064,072	
EAL15A	①	049,064,072	
EAL20A	①	049,064,072	
<b>Horizontal Auxilliary Heaters</b>			
EAMH5A	②	026,038	
EAMH8A	②	026,038	
EAMH10A	②	026,038	
EALH10A	②	049,064,072	
EALH15A	②	049,064,072	
EALH20A	②	049,064,072	
<b>Field Installed 1" Filter Rails, Must Order 2 Each Per Unit (Top &amp; Bottom) Note: Filter/Air Cleaner Not Included, Select From Below</b>			
46P828-98T	Vertical 1" Filter Rails	026	
46P828-96T	Vertical 1" Filter Rails	038	
46P828-97T	Vertical 1" Filter Rails	049,064,072	
<b>Field Installed 1" Filter Rails, Must Order 2 Each Per Unit (Top &amp; Bottom) Note: Filter/Air Cleaner Not Included, Select From Below</b>			
46P862-01T	Horizontal 1" Filter Rails	026	
46P863-01T	Horizontal 1" Filter Rails	038	
46P861-01T	Horizontal 1" Filter Rails	049,064	
46P864-01T	Horizontal 1" Filter Rails	072	
<b>Electronic Air Cleaner</b>			
EAC2024	Vertical Units (20x24)	026	
EAC2424	Vertical Units (24x24)	038	
EAC2830	Vertical Units (28x30)	049,064	
EAC3032	Vertical Units (30x32)	072	
EAC1824	Horizontal Units (18x24)	026,038	
EAC1832	Horizontal Units (18x32)	049	
EAC2037	Horizontal Units (20x37)	064	
EAC2042	Horizontal Units (20x42)	072	
<b>Disposable Pleated Filters, 1" MERV8</b>			
59P503B12	Vertical Units (20x24)	026	
59P503B27	Vertical Units (24x24)	038	
59P503B28	Vertical Units (28x30)	049,064	
59P503B21	Vertical Units (30x32)	072	
59P503B07	Horizontal Units (18x24)	026	
59P503B23	Horizontal Units (18x32)	038	
59P503B08	Horizontal Units (20x37)	049,064	
59P503B02	Horizontal Units (20x20)	072 ④	
59B503N24	Horizontal Units (20x22)	072 ④	

① Internal Mount, Electronic Control Board, 15-20kW Include Internal Fuses.

② Internal Mount Control Box, Coil Assembly External Mount, Electronic Control Board, 15-20kW include internal fuses

③ 6 Month Life, (Minimum Order Quantity 2)

④ 072 Horizontal unit requires both filters to span the width of the filter opening.

# Water to Water Packaged Units

## 1GW Water Packaged Units

1 2 3 4 5 6 7 8 9 10 11 12 13 14 15  
A 1 G W 0 4 0 N N H 1 0 C N \*

**Brand** \_\_\_\_\_  
A = American Standard

**Compressor Type** \_\_\_\_\_  
1 = Single Stage Compressor

**Product Category** \_\_\_\_\_  
G = Geothermal

**Product Type** \_\_\_\_\_  
W = Hydronic Packaged System (Water-to-Water)

**Nominal BTU's** \_\_\_\_\_  
Thousands of BTU's

**Discharge Air Configuration** \_\_\_\_\_  
N = None

**Return Air Configuration** \_\_\_\_\_  
N = None

**\*Heating and/or Cooling** ① \_\_\_\_\_  
H = Heating Only  
R = Heating and Cooling (Reversible)

**Voltage/Frequency/Phases** \_\_\_\_\_  
1 = 208-230/60/1

**\*Hot Water Options** ② \_\_\_\_\_  
0 = No Hot Water, No IntelliStart  
2 = Hot Water Generator without factory installed pump, No IntelliStart  
3 = No Hot Water, IntelliStart  
5 = Hot Water Generator without factory installed pump, IntelliStart

**\*Coax Options** ② \_\_\_\_\_  
C = Copper  
N = Cupronickel  
L = Source Cupronickel / Load Copper  
S = Source Copper / Load Cupronickel

**Blower Motor Options** \_\_\_\_\_  
N = None

**Vintage** \_\_\_\_\_  
\*Current Vintage of the Product

## 2GW Water Packaged Units

1 2 3 4 5 6 7 8 9 10 11 12 13 14 15  
A 2 G W 1 0 0 T N R 1 0 B N \*

**Brand** \_\_\_\_\_  
A = American Standard

**Compressor Type** \_\_\_\_\_  
2 = Two Stage Compressor

**Product Category** \_\_\_\_\_  
G = Geothermal

**Product Type** \_\_\_\_\_  
W = Hydronic Packaged System (Water-to-Water)

**Nominal BTU's** \_\_\_\_\_  
Thousands of BTU's

**Discharge Configuration** \_\_\_\_\_  
T = Top Mounted Connections  
R = Rear Mounted Connections

**Return Air Configuration** \_\_\_\_\_  
N = None

**Heating and/or Cooling** \_\_\_\_\_  
R = Heating and Cooling (Reversible)

**Voltage/Frequency/Phases** \_\_\_\_\_  
1 = 208-230/60/1

**Hot Water Options** \_\_\_\_\_  
0 = No Hot Water, No IntelliStart  
3 = No Hot Water, IntelliStart

**Coax Options** \_\_\_\_\_  
B = Brazed plate

**Blower Motor Options** \_\_\_\_\_  
N = None

**Vintage** \_\_\_\_\_  
\*Current Vintage of the Product

① Available on 040-075 only, Hot Water Generator requires field installed external pump kit.  
② 018-025 heating only models are available only with copper double wall vented load coax for potabale water.

# Water to Water Packaged Units

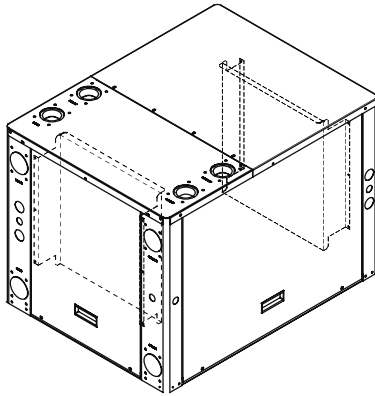

### 1GW Series

- Extended range operation (20-120° F EWT)
- Earth friendly R-410A refrigerant
- GW series microprocessor based controls
- Duration™ Scroll (single speed) compressors
- Expansion valve
- Special gray powder coated cabinet
- Factory computer run test
- ARI/ASHRAE/ISO 13256-1 performance certified and UL/ETL safety listed
- Fully insulated cabinet, coax HE, water piping and ref. lines
- Adjust temperature and configuration from control panel on front of units
- **10-year parts and 5-year labor allowance**

### 2GW Series

- Ultra-compact 25"W x 33"D x 24"H
- Standard waterlines out the back or front (field convertible via control box)
- Factory optional top waterlines
- High efficiency brazed plate heat exchanger
- High efficiency scroll compressors (2)
- Optional GeoStart
- FX10 control package with MUI interface
- Performance monitoring and communication through standard DDC protocols
- **10-year parts and 5-year labor allowance**

Geothermal

**Table GEO-10-A — 1GW - 2GW Hydronic Heat Pumps**

Unit Model No.	Power Supply Refrigerant Volts/Hz/Phase	Normal Cooling Capacity (Btuh)	Normal Heating Capacity (Btuh)	Dimensions (in.) H x W x D	Shipping Weight (lbs.)	Water Supply and Return Size	Min Circ Amp	Max Fuse
A1GW018	208-230/60/1	17,300	15,000	26.1x19.5x23.5	213	1	20.1	30
A1GW025	208-230/60/1	24,700	22,000	26.1x19.5x23.5	247	1	24.1	35
A1GW040	208-230/60/1	37,700	31,000	26.2x22.0x31.0	305	1	32.2	50
A1GW050	208-230/60/1	51,500	44,000	26.2x22.0x31.0	340	1 1/4	40.2	60
A1GW060	208-230/60/1	58,000	50,000	26.2x22.0x31.0	360	1 1/4	44.8	70
A1GW075	208-230/60/1	68,400	62,000	26.2x22.0x31.1	360	1 1/4	40.8	60
A2GW100	208-230/60/1	100,000	82,000	24.1x25.58x33.6	385	2	33.0/41.4	50/60
A2GW120	208-230/60/1	114,000	93,000	24.1x25.58x33.6	395	2	37.6/46.0	60/70
A2GW150	208-230/60/1	147,000	123,000	24.1x25.58x33.6	395	2	33.6/42.0	60/60
A2GW180	208-230/60/1	165,000	139,000	24.1x25.58x33.6	415	2	40.1/48.5	70/80

\*For models not listed and unit details, please refer to the Geothermal Hydronic Heat Pump Product Data publication.

**Models listed are representative ONLY. Please refer to model nomenclature for product line configuration.**

# Water to Water Packaged Units

**Table GEO-11-A — Optional Accessories 1GW**

Model Number	Description	Used With
<b>Circulating Pump Kits</b>		
24S516-10	Load-side low flow pump (Potable Water)	018, 025
EWPK1 <sup>①</sup>	Load-side pump kit, 1" cast iron volute	018, 025, 040
EWPK2	Load-side pump kit, 1" bronze volute	018, 025
EWPK3 <sup>①</sup>	Load-side pump kit, 1 1/4" cast iron volute	050, 060, 075
13P003B	Low voltage pump signal relay (combined source pumps)	018, 025, 040, 050, 060, 075
<b>Water Connection Kits</b>		
MA4FPT	1" MPT x 1" FPT w/1/4 tap, Load Side W-W	018, 025, 040
MA5FPT	1 1/4" MPT x 1" FPT w/1/4 tap, Load Side W-W	050, 060, 075
2-HVAC-1.00X24	Stainless steel hose kit 1"	018, 025, 040
2-HVAC-1.25X24	Stainless steel hose kit 1 1/4"	050, 060, 075
<b>Hot Water Generator Pump Kit</b>		
DPK5	Includes 230v 1/25 hp pump and fittings	040, 050, 060, 075
<b>Air Pads</b>		
AP2430	AP= High density plastic	018, 025, 040
AP32	AP= High density plastic	050, 060, 075
APF2428	2" PEX foam, cutable	018, 025
APF2634	2" PEX foam, cutable	040, 050, 060, 075

<sup>①</sup> Not for use in 018 and 025 potable water applications.

**Table GEO-11-B — Optional Accessories 2GW**

Model Number	Description
<b>Hose Kits<sup>②</sup></b>	
CR6UBY-200-24	2" Stainless Steel hose kit, Y-Strainer, ball valves, and end fittings
<b>Water Connection Kit<sup>①</sup></b>	
CKNDW1	Source side OR Load side unit fittings, P/T plugs
<b>Large Flow Centers<sup>②</sup></b>	
FCL1-5028	1 Grundfos 3 speed pump (28 feet of head at 50 GPM)
FCL2-5028	2 Grundfos 3 speed pump (56 feet of head at 50 GPM)
FCL1-5038	1 Grundfos 3 speed pump (38 feet of head at 50 GPM)
FCL2-5038	2 Grundfos 3 speed pump (76 feet of head at 50 GPM)
FCL1-5055	1 Grundfos 3 speed pump (55 feet of head at 50 GPM)
FCL2-5055	2 Grundfos 3 speed pump (110 feet of head at 50 GPM)
<b>Load-Side Pump (pump and 2 "GL" fittings)<sup>②</sup></b>	
PML32-160	1 Grundfos 3 speed pump (28 feet of head at 50 GPM)
PML40-160	1 Grundfos 3 speed pump (38 feet of head at 50 GPM)
PML40-240	1 Grundfos 3 speed pump (55 feet of head at 50 GPM)
<b>Large Flow Centers Fittings (sets of 2)<sup>②</sup></b>	
GL6FPT	1.5" FPT X 2" GeoLink
GL8FPT	2" FPT X 2" GeoLink
GL-FPL	Flushing Adapter
<b>Flow Switch Kit</b>	
FPS300	Flow Switch Kit
<b>Connection Kit</b>	
CK5L	1 1/4" MPT X 1 1/4" hose barb, brass elbow w/ 1/4" P/T plugs
<b>Rubber Hose Kit w/ Strainer</b>	
CK5L-XLS	CK5L, 2 - 8' 1 1/4" rubber hose, pair 1 1/4" hose barb x 1 1/4 XL style fittings, steel hose clamps, with mesh bronze strainer

<sup>①</sup> This part can be used for both load and source side. 2 kits will need to be purchased for fittings for both sides.

<sup>②</sup> Drop shipped from vendor. Does not include freight.

# HydroLogic™ Control

- Water to Water Load Side Zone Control
- Menu Driven Software
- Adjustable setpoints and deadbands
- Three control strategies
- Lead/Lag logic
- Utilizes Geo Storage tank sensor
- **5-year parts & labor allowance warranty included in list price**

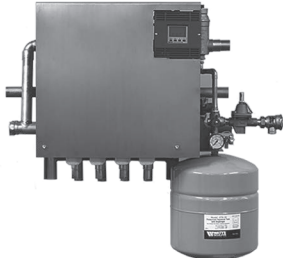

**Table GEO-12-A — HydroLogic™ Control**

Model Number	Specification	Unit Compatibility
HZC	HydroLogic™ Control Only	All
HLP2EXPU	HydroLogic™ Control 2 Zone Expansion Panel - uninsulated	All
HLP4EXPU	HydroLogic™ 4 Zone Expansion Panel - uninsulated	All
HLP2EXPI	HydroLogic™ 2 Zone Expansion Panel - insulated	All
HLP4EXPI	HydroLogic™ 4 Zone Expansion Panel - insulated	All
HLPC3U	HydroLogic™ Control Panel - Combination Systems - Up to 3 Tons - uninsulated	*2GY
HLPC6U	HydroLogic™ Control Panel - Combination Systems - Up to 6 Tons - uninsulated	*2GY
HLPW3U	HydroLogic™ Control Panel - Water-to-Water Systems - Up to 3 Tons - uninsulated	*1GW, *1GH
HLPW6U	HydroLogic™ Control Panel - Water-to-Water Systems - Up to 6 Tons - uninsulated	*1GW, *1GH
HLPC3I	HydroLogic™ Control Panel - Combination Systems - Up to 3 Tons - insulated	*2GY
HLPC6I	HydroLogic™ Control Panel - Combination Systems - Up to 6 Tons - insulated	*2GY
HLPW3I	HydroLogic™ Control Panel - Water-to-Water Systems - Up to 3 Tons - insulated	*1GW *1GH
HLPW6I	HydroLogic™ Control Panel - Water-to-Water Systems - Up to 6 Tons - insulated	*1GW *1GH
TP42H01	Touchscreen Thermostat - 4 heat / 2 cool	All
TP10H01	Radiant Touchscreen Thermostat - 1 heat / 0 cool	All
TA10H01	Radiant Thermostat - 1 Heat / 0 Cool	All

Note: HZ0 is for tank control only with no zones.  
HydroLogic Parts Supplier Mfg. by Watts

Geothermal

# Triple Function Hybrid Water to Air Systems

## GY Series Hybrid Systems

1 2 3 4 5 6 7 8 9 10 11 12 13 14  
A 2 G Y 0 3 8 T R R 1 0 C 1

- Brand** \_\_\_\_\_  
A = American Standard
- Compressor Type** \_\_\_\_\_  
2 = Single Stage Compressor
- Product Category** \_\_\_\_\_  
G = Geothermal
- Product Type** \_\_\_\_\_  
Y = Premium Packaged System  
(Water-to-Air plus Radiant Heating)
- Nominal BTU's** \_\_\_\_\_  
Thousands of BTU's
- \*Discharge Air Configuration** \_\_\_\_\_  
T = Top (Vertical)  
R = Rear (Vertical 049-072 Only)
- \*Return Air Configuration** \_\_\_\_\_  
L = Left  
R = Right
- Heating and/or Cooling** \_\_\_\_\_  
R = Heating and/or Cooling
- Voltage/Frequency/Phases** \_\_\_\_\_  
1 = 208-230/60/1
- \*Hot Water Options** \_\_\_\_\_  
0 = No Hot Water, No IntelliStart  
2 = Hot Water Generator without factory installed pump  
(022-072 Only) No IntelliStart  
3 = No Hot Water, IntelliStart  
5 = Hot Water Generator without factory installed pump  
(022-072 Only) IntelliStart
- \*Coax Options** \_\_\_\_\_  
C = Copper  
N = Cupronickel  
L = Source Cupronickel/Load Copper  
S = Source Copper/Load Cupronickel
- \*Blower Motor Options** \_\_\_\_\_  
1 = ECM Blower  
2 = Oversized ECM Blower (038 & 049 Only)

**Capacities**  
Two Stage = 038, 049, 064, 072

\*Select desired options to create specific model number.  
Note: The factory installed water option (hot water generator) does not include factory mounted circulating pump or temperature control.  
DPK5 (ordered separately) includes field installed circulator, hot water tank adaptor, temperature limit and installation instructions.

Geothermal

# Triple Function Hybrid Water to Air Systems

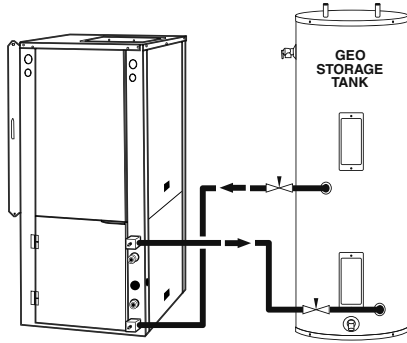

- Extended range operation (20-120°F EWT)
- Hybrid "3 in 1" system-space heat, space cool, hot water to radiant floor zones
- Optional hot water generator
- Earth friendly R-410A refrigerant
- Premier 2 microprocessor based controls
- Duration™ dual capacity scroll Compressor
- ECM variable speed fan motor
- FormiShield™ coated air coil
- Expansion valve
- Optional internal electric heat
- 1" Swivel fittings
- Special gray powder coated heavy gauge galvanized cabinet
- Factory computer run test
- ARI/ASHRAE/ISO 13256-1 performance certified and UL/ETL safety listed
- 2" filter rack with MERV 11 filter Included
- **10-year parts and 5-year labor allowance**

**Table GEO-14-A — GY Series Hybrid Systems**

Unit Model No.	Power Supply Volts/Hz/Phase	Nominal Cooling Capacity (Btuh)	Dimensions (in.) H x W x L	Shipping Weight (lbs.)	Supply Opening (WxD)	Return Opening (DxH)	Filter Size	Water Inlet/Outlet Size	Min Circ Amp	Max Fuse
A2GY038	208-230/60/1	35,200	50.4x25.6x31.6	445	18x18	28x26	28x30	1" Swivel	31.2	45
A2GY049	208-230/60/1	43,800	54.4x25.6x31.6	550	18x18	28x30	32x30	1" Swivel	36.8	50
A2GY064	208-230/60/1	59,400	58.4x25.6x31.6	560	18x18	28x34	36x30	1" Swivel	45.5	70
A2GY072	208-230/60/1	69,100	58.4x25.6x31.6	560	18x18	28x34	36x30	1" Swivel	47.5	70

\* For models not listed and unit details, please refer to the Geothermal Heat Pump with Water Heating for Radiant Floor Applications Product Data publication.

**Table GEO-14-B — Optional Accessories**

Model Number	Description	Used With
<b>Disposable Pleated Filters, 2" MERV11<sup>①</sup></b>		
59P509-08	Vertical Units (28x30)	038
59P509-07	Vertical Units (30x32)	049
59P509-06	Vertical Units (30x36)	064, 072
<b>Air Pads for Vertical Units</b>		
AP32	AP - High density plastic	038, 049, 064, 072
APF2634	APF - 2" PEX foam, cutable	038, 049, 064, 072
<b>Vertical Auxiliary Heaters</b>		
EAL10A <sup>③</sup>	Vertical Auxiliary Heaters	038, 049, 064, 072
EAL15A <sup>③</sup>	Vertical Auxiliary Heaters	038, 049, 064, 072
EAL20A <sup>③</sup>	Vertical Auxiliary Heaters	049, 064, 072
<b>Horizontal Auxiliary Heaters</b>		
EALH10A <sup>④</sup>	Horizontal Units (Rear Discharge Units Only)	038, 049, 064, 072
EALH15A <sup>④</sup>	Horizontal Units (Rear Discharge Units Only)	038, 049, 064, 072
EALH20A <sup>④</sup>	Horizontal Units (Rear Discharge Units Only)	049, 064, 072
<b>Hot Water Generator Pump Kit</b>		
DPK5 <sup>⑤</sup>		038, 049, 064, 072
<b>Thermostats (All Controls- 3H, 2C, Dual Fuel Compatible)</b>		
AZONE950AC52ZA	950 Premium Control (Requires Relay Panel)	
BAY24VRPAC52DA	24 Volt Interface Relay Panel for 950 Control	
ACONT802AS32DA	Programmable Touch Screen Digital Control	
ACONT803AS32DA	Programmable Touch Screen Digital Control with Dehumidification Control	
ACONT402AN32DA	Non-Programmable Comfort Control	

① Minimum order qty. 2.

② Bottom Flow 36-72.

③ Sequenced Operation, 15-20kW include internal fuses.

④ Sequenced Operation, 15-20kW include internal fuses. Rear discharge units only.

⑤ Must be purchased with any Y with hot water generator option.

Note: For hydronic accessories, please see hydronic price book.

**Models listed are representative ONLY. Please refer to model nomenclature for product line configuration.**

# Split Heat Pump Units

## 2GN Indoor Split Heat Pumps

1 2 3 4 5 6 7 8 9 10 11 12 13 14 15  
A 2 G N 0 2 2 N N R 1 0 C N \*

**Brand** \_\_\_\_\_  
A = American Standard

**\*Compressor Type** \_\_\_\_\_  
2 = Two Stage Compressor

**Product Category** \_\_\_\_\_  
G = Geothermal

**Product Type** \_\_\_\_\_  
N = Premium Split System Interior Grade

**Nominal BTU's** \_\_\_\_\_  
Thousands of BTU's

**Discharge Air Configuration** \_\_\_\_\_  
N = None

**Return Air Configuration** \_\_\_\_\_  
N = None

**Heating and/or Cooling** \_\_\_\_\_  
R = Heating and Cooling

**Voltage/Frequency/Phases** \_\_\_\_\_  
1 = 208-230/60/1

**\*Hot Water Options** \_\_\_\_\_  
0 = No Hot Water, No IntelliStart  
1 = Hot Water Generator with external factory pump, No IntelliStart  
3 = No Hot Water, IntelliStart  
4 = Hot Water Generator with external factory pump, IntelliStart

**\*Coax Options** \_\_\_\_\_  
C = Copper  
N = Cupronickel

**Blower Motor Options** \_\_\_\_\_  
N = None

**Vintage** \_\_\_\_\_  
\*Current Vintage of the Product

**Capacities**  
Dual = 026, 038, 049, 064

\*Select desired options to create specific model number.

## GE Outdoor Split Heat Pumps

1 2 3 4 5 6 7 8 9 10 11 12 13 14 15  
A 2 G E 0 2 6 N N R 1 0 C A \*

**Brand** \_\_\_\_\_  
A = American Standard

**Compressor Type** \_\_\_\_\_  
2 = Two Stage Compressor

**Product Category** \_\_\_\_\_  
G = Geothermal

**Product Type** \_\_\_\_\_  
E = Premium Split System Exterior Grade

**Nominal BTU's** \_\_\_\_\_  
Thousands of BTU's

**Discharge Air Configuration** \_\_\_\_\_  
N = None

**Return Air Configuration** \_\_\_\_\_  
N = None

**Heating and/or Cooling** \_\_\_\_\_  
R = Heating and Cooling

**Voltage/Frequency/Phases** \_\_\_\_\_  
1 = 208-230/60/1

**\*Hot Water Options** \_\_\_\_\_  
0 = No Hot Water, No IntelliStart  
3 = No Hot Water, IntelliStart

**\*Coax Options** \_\_\_\_\_  
C = Copper  
N = Cupronickel

**Flow Center Options** \_\_\_\_\_  
A = One Pump Flow Center  
B = Two Pump Flow Center

**Vintage** \_\_\_\_\_  
\*Current Vintage of the Product

**Capacities**  
Dual = 026, 038, 049, 064

\*Select desired options to create specific model number.

Geothermal



# Split Heat Pump Units

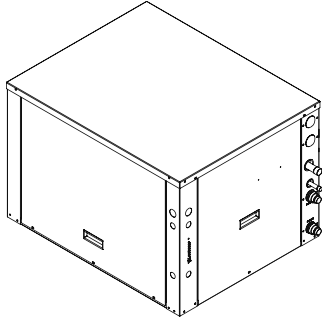

- Extended range operation (20-120°F EWT)
- Earth friendly R-410A refrigerant
- Duration™ Dual capacity scroll compressor
- Premier 2 microprocessor based controls with fault Indicator Lights
- Expansion valve
- 1" Swivel fittings
- Special gray powder coated heavy gauge galvanized cabinet
- Accumulator on all models
- Factory computer run test
- ARI/ASHRAE/ISO 13256-1 performance certified and UL/ETL safety listed
- **10-year parts and 5-year labor allowance**

**Table GEO-16-A — 2GN Indoor Split Heat Pumps**

Unit Model No.	Power Supply Volts/Hz/Phase	Normal Cooling Capacity (Btuh)	Dimensions (in.) H x W x L	Shipping Weight (lbs.)	Refrigerant Suction Line ①	Refrigerant Liquid Line ①	Min Circ Amp	Max Fuse
A2GN026	208-230/60/1	26,200	19.5x22.5x26.5	209	5/8	3/8	19.9	30
A2GN038	208-230/60/1	35,000	21.25x25.5x31.5	256	3/4	3/8	24.4	40
A2GN049	208-230/60/1	47,700	21.25x25.5x31.5	270	3/4	3/8	31.8	50
A2GN064	208-230/60/1	59,100	21.25x25.5x31.5	291	7/8	1/2	39.3	70

① 20' Line Set Length. Consult Guide for other lengths.

\* For models not listed and unit details, please refer to the Geothermal Indoor Split Heat Pump Product Data publication.

**Table GEO-16-B — Optional Accessories**

Model Number	Description	Used With
<b>Air Pads</b>		
AP32	AP= High density plastic	026, 038, 049, 064
APF2634	APF= 2" PEX foam, cutable	026, 038, 049, 064
<b>Thermostats (All Controls- 3H, 2C, Dual Fuel Compatible)</b>		
AZONE950AC52ZA	950 Premium Control (Requires Relay Panel)	
BAY24VRPAC52DA	24 Volt Interface Relay Panel for 950 Control	
ACONT402AN32DA	Non-Programmable Comfort Control	
ACONT824AS42DA	24 Volt Color Touchscreen Control	

Geothermal

**Models listed are representative ONLY. Please refer to model nomenclature for product line configuration.**

# Split Heat Pump Units

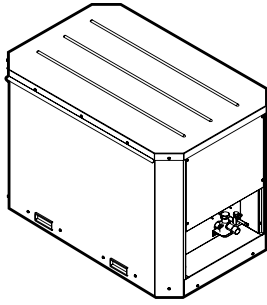

- Extended range operation (20-120°F EWT)
- Earth Friendly R-410A Refrigerant
- Rated for outdoor installation
- Premier 2 microprocessor based controls with fault indicator lights
- Duration™ 2 stage scroll compressor
- Expansion valve
- Gray powder coated heavy gauge galvanized cabinet
- Accumulator on all models
- Factory computer run test
- ARI/ASHRAE/ISO 13256-1 performance certified and UL/ETL safety listed
- Internally mounted flow center in cabinet (factory installed)
- **10-year parts and 5-year labor allowance**

**Table GEO-17-A — 2GE Outdoor Split Heat Pumps**

Unit Model No.	Power Supply Volts/Hz/Phase	Nominal Cooling Capacity (Btuh)	Dimensions (in.) H x W x L	Shipping Weight (lbs.)	Refrigerant Suction Line ①	Refrigerant Liquid Line ①	Min Circ Amp	Max Fuse
A2GE026	208-230/60/1	26,200	26.7x36.0x23.9	209	5/8	3/8	17	25
A2GE038	208-230/60/1	35,000	26.7x36.0x23.9	256	3/4	3/8	23.4	40
A2GE049	208-230/60/1	47,700	26.7x36.0x23.9	270	3/4	3/8	27.9	50
A2GE064	208-230/60/1	59,100	26.7x36.0x23.9	291	7/8	1/2	32.4	60
A2GE072	208-230/60/1	62,700	26.7x36.0x23.9	310	7/8	1/2	34	60

① 20' Line Set Length. Consult Guide for other lengths.

\* For models not listed and unit details, please refer to the Geothermal/Water Source Outdoor Split Heat Pump Product Data publication.

**Table GEO-17-B — Optional Accessories**

Model Number	Description	All GE Unit Sizes
<b>Mounting Pad</b>		
AP3042	Bramec III, 6"x 6" modular construction	
<b>Thermostats (All Controls- 3H, 2C, Dual Fuel Compatible)</b>		
AZONE950AC52ZA	950 Premium Control (Requires Relay Panel)	
BAY24VRPAC52DA	24 Volt Interface Relay Panel for 950 Control	
ACONT402AN32DA	Non-Programmable Comfort Control	
ACONT824AS42DA	24 Volt Color Touchscreen Control	

**Models listed are representative ONLY. Please refer to model nomenclature for product line configuration.**

## Air Handlers and Coils

Geothermal

### TAMG Air Handler

1 2 3 4 5 6 7 8 9 10 11 12 13 14 15  
T A M G A 0 C 3 6 H 3 1 S A C

- Brand  
T = Best  
G = Good
- Product Type  
A = Air Handler
- Convertability  
M = Multi-poise 4-way  
F = Upflow Front Return, 3-way  
T = 3-way
- Product Tier  
2 = Good, Entry Level Feature Set  
4 = Better, Retail Replacement Mid Effy.  
5 = Better, Entry Level High Effy., Multi-Speed  
7 = Best, Retail Replacement High Effy., Variable-Speed  
8 = Best, Retail Ultimate High Effy., Variable-Speed  
G = Best, Geothermal
- Major Design Change
- No Descriptor  
0 = Air Handler / Coil
- Size (Footprint)  
A = 17.5 x 21.5  
B = 21.0 x 21.5  
C = 23.5 x 21.5
- Cooling Size: Air Handler or Coil  
0-9 = AH Coil - 1000 BTU's (24, 36, 48, 60)
- Airflow Type & Capability  
S = Low Effy. PSC, 1-5 - nom. Tonnage (cfm/ton)  
M = Mid Effy. Multi-Speed, 1-5 - nom. Tonnage (cfm/ton)  
H = High Effy. Variable, 1-5 - nom. Tonnage (cfm/ton)  
V = High Effy. Variable, 1-5 - nom. Tonnage (cfm/ton)
- Power Supply  
1 = 208-230/1/60
- System Control Type  
S = Standard - 24 VAC  
C = CLII 13.8 VDC
- Minor Design Change
- Unit Parts Identifier

### GCX Coils

1 2 3 4 5 6 7 8 9 10 11 12 13 14  
A G C X C R 0 2 6 A M A A X

- Brand  
A = American Standard
- Product Category  
G = Geothermal
- Product Type  
C = Split System Dual Fuel Coil
- Coil Design  
X = Direct Expansion  
Evaporator Coil TXV Included
- Coil Cabinet  
C = Cabinet Encased  
U = Uncased
- Model Type  
R = Refrigerant Coil  
H = Hydronic Coil
- Nominal Coil Capacity  

Refrigerant Models	Recommended Airflow CFM
026 M bth	800-980
036 M bth	1225
048 M bth	1425-1625
060 M bth	1760

Hydronic Models	Recommended Airflow CFM
060 M bth	1760
- Coil Width  
A = 20.8" / 20.0"
- Airflow Configuration  
Cased = Multi-poise  
Uncased = Multi-poise
- Series  
A = Current
- Vintage  
A = Current
- Minor Design Change - not orderable

### Hydronic Air Handler

1 2 3 4 5 6 7 8 9 10 11 12 13 14  
A G A 2 6 H 0 0 0 1 1 M S A

- Brand  
A = American Standard
- Product Category  
G = Geothermal
- Product Type  
A = Split System Air Handler
- Unit Capacity  

Hydronic Models	Recommended Airflow CFM
26 = 026 M bth	925
36 = 036 M bth	1225
48 = 048 M bth	1625
60 = 060 M bth	1625
- Air Coil Type  
H = Hydronic
- Electric Heat  
00 = No Electric Heat  
05 = 05 kW  
10 = 10 kW  
15 = 15 kW  
20 = 20 kW
- Disconnect  
0 = No Breaker Installed
- Motor/Blower  
1 = ECM Available Only
- Power Supply  
1 = 208-230/1/60
- Applications  
M = Multi-Poise  
042-060 Downflow Application Only Requires Kit NAHBC
- System Control Type  
S = Standard - 24 VAC
- Series  
A = Current

For complete equipment / combination selections, installation instructions and warranty information, please refer to Product Data/Ratings and/or Installers Guides and Limited Warranty Handbooks.

# Split Air Handlers

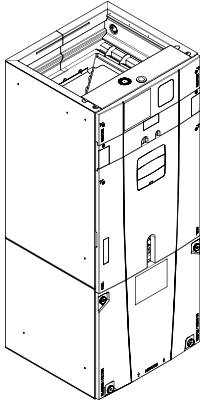

- Unique cabinet design
  - 2% or less air leakage
  - Double wall foamed cabinet system
  - $\geq$  R-4.2 insulating value (Avg. Insulating Value R-8.2)
  - No loose fiber design
  - Smooth cleanable interior design
  - Sweat eliminating design
  - Composite foamed cabinet doors
  - Water proof cabinet design
  - Integrated horizontal drain pans
  - Modular cabinet
- Control board protection pocket built into cabinet wall
- Multi-position up/down flow horizontal left/right
- Variable speed ECM motor
- Electronic Expansion Valve (EEV)
- Aluminum coil with integrated slide deck for easy removal and polarized plug connections on coil EEV
- Molded in 1" standard filter rail
- Alert port to view control board codes without door removal
- **Vortica**<sup>®</sup> blower with polarized plug connections and integrated slide deck for easy removal.
- **10-year parts warranty registered**
- **No labor warranty. Extended Labor Warranty packages available**

**Table GEO-19-A — TAMG Variable Speed R-410A with Comfort-R™ Enhanced Mode Option 200-230/1/60**

Unit Model No.	Cooling Capacity (Btuh)	Dimensions (in.) H x W x D	Shipping Weight (lbs.)	Supply Opening	Return Opening	Filter Sizes	Line Size	
							Gas	Liquid
TAMGA0A24H21SC	24000	49.9x 17.5x 21.8	126	14.5x 14.35	14.5x 17.15	16x20x1	3/4	3/8
TAMGA0C36H31SC	36000	56.9x 23.5x 21.8	157	20.5x 14.35	20.5x 17.15	22x20x1	7/8	3/8
TAMGA0C48H41SC	48000	61.7x 23.5x 21.8	174	20.5x 14.35	20.5x 17.15	22x20x1	7/8	3/8
TAMGA0C60H51SC	60000	61.7x 23.5x 21.8	175	20.5x 14.35	20.5x 17.15	22x20x1	7/8	3/8

**Table GEO-19-B — Optional Accessories**

Model Number	Description	Used With
BAYEVAC05BK1AB	5 kW (16400 BTU) electric heater, breakers	TAMGA0A24-C60
BAYEVAC05LG1AB	5 kW (16400 BTU) electric heater, lugs	TAMGA0A24-C60
BAYEVAC08BK1AB	8 kW (26200 BTU) electric heater, breakers	TAMGA0A24-C60
BAYEVAC08LG1AB	8 kW (26200 BTU) electric heater, lugs	TAMGA0A24-C60
BAYEVAC10BK1AB	10 kW (32800 BTU) electric heater, breakers	TAMGA0A24-C60
BAYEVAC10LG1AB	10 kW (32800 BTU) electric heater, lugs	TAMGA0A24-C60
BAYEVBC15BK1AB	15 kW (49200 BTU) electric heater, breakers	TAMGA0C36-C60
BAYEVBC20BK1AA	20 kW (65600 BTU) electric heater, breakers	TAMGA0C36-C60
BAYEVCC25BK1AA	25 kW (82000 BTU) electric heater, breakers	TAMGA0C48-C60
BAYEVAC10LG3AB	10 kW (32800 BTU) electric heater, lugs, 3-Phase	TAMGA0A24-C60
BAYEVBC15LG3AB	15 kW (49200 BTU) electric heater, lugs, 3-Phase	TAMGA0C36-C60
BAYWVAA05SC1AA	40,000 BTUH, RS-485 control, hydronic heater, for A <sup>ⓐ</sup> cabinet	TAMGA0A24
BAYWVCC08SC1AA	65,000 BTUH, RS-485 control, hydronic heater, for C <sup>ⓐ</sup> cabinet	TAMGA0C36-C60
BAYWVCC11SC1AA	100,000 BTUH, No control, hydronic heater, for C cabinet	TAMGA0C60
BAYWVBRD485	RS-485 control for BAYWVCC11SC1AA	TAMGA0C60
BAYSUPFLGAA	Supply Duct Flange A cabinet	TAMGA0A24
BAYSUPFLGCA	Supply Duct Flange C cabinet	TAMGA0C36-C60
BAYRETFLGAA	Return Duct Flange A cabinet	TAMGA0A24
BAYRETFLGCA	Return Duct Flange C cabinet	TAMGA0C36-C60
TASB175SB <sup>ⓐ</sup> ⓐ	Plenum Stand with Integrated Sound Baffle A cabinet	TAMGA0A24
TASB235SB <sup>ⓐ</sup> ⓐ	Plenum Stand with Integrated Sound Baffle C cabinet	TAMGA0C36-C60
MTISRKIT1620 <sup>ⓐ</sup>	Side Return Kit with 16"x20" Filter	TAMGA0A24-C60
TASSBK175 <sup>ⓐ</sup> ⓐ	Sound Baffle Kit 17.5" Cabinet	TAMGA0A24
TASSBK235 <sup>ⓐ</sup> ⓐ	Sound Baffle Kit 23.5" Cabinet	TAMGA0C36-C60
BAYSPEKT200	Single Power Entry Kit	TAMGA0A24-C60
BAYSRKIT100	Side Return Kit	TAMGA0A24-C60
BAYICKSKIT01	Internal Condensate Switch Kit	TAMGA0A24-C60
BAYHHKIT001	Horizontal Hanger Kit	TAMGA0A24-C60
BAYUVCLK001	UV Lights	TAMGA0A24-C60
BAYLVKIT100	Low Voltage Conduit Entry Kit	TAMGA0A24-C60

ⓐ A Cabinet is 17.5" wide and C Cabinet is 23.5" wide.  
 ⓐ Contact your distributor for information.  
 ⓐ In return plenum applications, use TASSBK kits for sound reduction.  
 ⓐ In open air applications, Plenum Stand with Sound Baffle provides sound reduction.

Geothermal

**Models listed are representative ONLY. Please refer to model nomenclature for product line configuration.**

# Heaters - Split Air Handlers

Table GEO-20-A — Heaters

AIR HANDLER	HEATER MODEL NUMBER BAYEV-								
MODEL NUMBER	AC05BK1AB 4.80 Kw BK	AC05LG1AB 4.80 Kw LG	AC08BK1AB 7.68 Kw BK	AC08LG1AB 7.68 Kw LG	AC10BK1AB 9.60 Kw BK	AC10LG1AB 9.60 Kw LG	BC15BK1AB 14.40 Kw BK	BC20BK1AA 19.20 Kw BK	CC25BK1AA 24.00 Kw BK
TAMGA0A24H21SC	Y	Y	Y	Y	Y	Y	—	—	—
TAMGA0C36H31SC	Y	Y	Y	Y	Y	Y	Y	Y	—
TAMGA0C48H41SC	Y	Y	Y	Y	Y	Y	Y	Y	Y
TAMGA0C60H51SC	Y	Y	Y	Y	Y	Y	Y	Y	Y

AIR HANDLER	HEATER MODEL NUMBER BAYEV-	
MODEL NUMBER	AC10LG3AB 9.60 Kw LG	BC15LG3AB 14.40 Kw LG
TAMGA0A24H21SC	Y	—
TAMGA0C36H31SC	Y	Y
TAMGA0C48H41SC	Y	Y
TAMGA0C60H51SC	Y	Y

Geothermal

## Hydronic Air Handlers

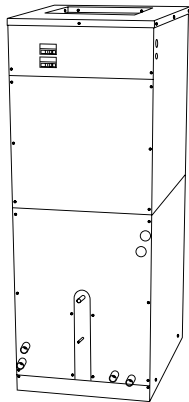

- Heavy gauge galvanized steel with metallic silver powder coat finish
- Full interior cabinet insulated with 1/2" foil lined acoustic fiber insulation
- Multi-Poise configuration
- 2-Piece separatable cabinet for ease of installation
- Slide out blower assembly
- Full ECM motor
- 1" Filter rack with MERV 4 filter included
- Two stainless steel drain pans
- Hydronic "A" coil option
- ARI/ASHRAE/ISO 13256-1 performance certified and UL/ETL safety listed
- **10-year parts and 5-year labor allowance**

Table GEO-20-B — GA Hydronic Air Handlers

Unit Model No.	Power Supply Volts/Hz/Phase	Rated Airflow (CFM)	Dimensions (in.) H x W x L	Shipping Weight (lbs.)	Supply Opening (DxH)	Return Opening (DxH)	Filter Size	Water Inlet/ Outlet Size	Min Circ Amp	Max Fuse
AGA26H	208-230/60/1	925	57.3x21.0x26.1	220	18x18	17x22	20x24	7/8	5	10
AGA36H	208-230/60/1	1225	57.3x21.0x26.1	220	18x18	17x22	20x24	7/8	5	10
AGA48H	208-230/60/1	1625	57.3x21.0x26.1	220	18x18	17x22	20x24	7/8	8.8	15
AGA60H	208-230/60/1	1760	57.3x21.0x26.1	220	18x18	17x22	20x24	7/8	8.8	15

For complete equipment / combination selections, installation instructions and warranty information, please refer to Product Data/Ratings and/or Installers Guides and Limited Warranty Handbooks.

## GCX - Coils

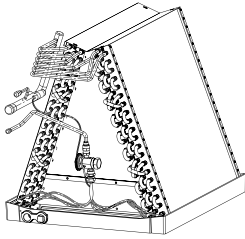

- "A" Coil Design
- Electro-Coated Coil
- Copper Tube/ Aluminum Fin Design
- Factory Configured for Upflow and Horizontal Left
- Field Configurable for Downflow or Horizontal Right
- Factory Installed TXV
- Sweat Connections
- Condensate Drain Pan Included

**Table GEO-21-A — Common Model Configurations**

Unit Model No. Cased Coil	Unit Model No. Matched Heat Pump	Recommended Airflow (CFM)	Cased Cabinet Dimensions (in.) H x W x D	Supply Connection Width/ Depth	Uncased Dimensions (in.) H x W x D	Shipping Weight (lbs.)	Hydronic Connection In/Out	Condensate Drain Connection, FTP
GCXCR026	T2GN/GE026	925	29.1x20.8x26.0	19.0/24.1	20.7x20.0x24.9	100	N/A	3/4
GCXCR036	T2GN/GE038	1225	29.1x20.8x26.0	19.0/24.1	20.7x20.0x24.9	100	N/A	3/4
GCXCR048	T2GN/GE049	1625	29.1x20.8x26.0	19.0/24.1	20.7x20.0x24.9	100	N/A	3/4
GCXCR060	T2GN/GE064	1760	29.1x20.8x26.0	19.0/24.1	20.7x20.0x24.9	100	N/A	3/4
GCXCR060	T2GN/GE072	1760	29.1x20.8x26.0	19.0/24.1	20.7x20.0x24.9	100	N/A	3/4
GCXCH060	T2GN/GE064	1760	N/A	19.0/24.1	25.2x20.0x24.9	100	7/8	3/4

**Models listed are representative ONLY. Please refer to model nomenclature for product line configuration.**

## Standard Accessories

**Table GEO-22-A — Accessories**

Model Number	Description
<b>GL Flow Centers and Accessories</b>	
Pre-assembled with pump(s), 3-way valves with flush ports, internal components injected with foam. Horizontal or vertical mounting capability. GL features a Die Cast Brass valve and pump volute, high-impact polystyrene cabinet, GL5PES, and uses GeoLink Connection Kits.	
FC1-GL	1 Grundfos Pump
FC2-GL	2 Grundfos Pumps
2 Brass adapters with P/T plugs for unit connection, 10' reinforced 1" rubber hose for unit to flow center and two 1" GL x 1" hose barb for flow center connection.	
CK4L-GLI	Unit Connection Kit 1" GL x 1" Insert
<b>Rubber Hose</b>	
1" rubber hose for connection from unit to flow center.	
RH550	50' of 1" Rubber Hose
<b>Geo Storage Tank</b>	
Use with Hot Water Generator Option or Hydronic Storage.	
GEO-STORAGE- 80	63 <sup>1</sup> / <sub>4</sub> x 24
GEO-STORAGE-120	63 <sup>1</sup> / <sub>4</sub> x 28
<b>Loop Expansion Tank</b>	
LET	1 <sup>1</sup> / <sub>4</sub> Socket Fusion, <sup>3</sup> / <sub>4</sub> Gallon Capacity
<b>Anti-Freeze</b>	
EN2-D	55 Gallon Drum - Environol 2000 Pure
EN2-P	5 Gallon Pail - Environol 2000 Pure (minimum order quantity for EN2-P is 5 pails.)
<b>Premier IntelliZone 4 Zone Control - with Cabinet and 10' Blower Wiring Harness</b>	
Multiple level zone calls communicate exact zone load requirements. Controls up to 4 zones with dual capacity compressor (2 with single-speed compressor). Direct control of ECM2 fan motor to match needs of the space. Five fan speeds on line, up to 12 speeds available. Zone sizes as small as 25% of whole house (dual capacity compressor). Individual zone selectable savings or comfort mode. Four upstaging options: normal, quicker, faster or faster with timer for various application scenarios.	
ZCK4	See Parts and Accessories Catalog for Rectangular and Round Dampers
ZTK240	Zone Transformer Kit - 208/240V - 24V
ZBHE	Zone Blower Harness Extension - 10', Extends ECM2 Harness
<b>Earth Loop Flushing System</b> <sup>①</sup>	
High volume, high head, self-priming pump. Quick connect hoses. Heavy duty design. Mounted on a cart. All pipe is schedule 80 polypropylene.	
LFC-F	
GL-FP	1" Cam Lever Male Elbow for Flush Port.
<b>Adapter Sets</b>	
2 pcs. included in each set.	
92B025-99	Unit Connector Insulation Kit.
GLGH	Garden Hose Adapter for Loop Pump Replacement.
<b>Service Tool Kit</b>	
Includes 0-100 PSI Pressure Gauge, Pressure Gauge to PT Port Adapter, Digital Thermometer, Loop Pressurizer, Alcohol Specific Gravity Hygrometer.	
GEOHERMAL-STK	99P247A01, LP1, CAMT, 11P538A01, 11P538A02 (Includes DPT160, PG100, GA125)

Note: See Parts and Accessories Catalog for Complete Listing of Geothermal Accessory Items.

# Ductless Single Zone System Pro Series Single Phase – 1-1/2-4 Tons

**Table DU-1-A — Up to 20 SEER R-410A Single Zone System HP — Single Phase, 1-1/2 to 4 Ton<sup>①②</sup>**

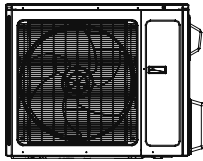

**4TXU20**

Outdoor Model Number Indoor Model Number	Power Supply	Nom. Cap. Cooling (BTUH)	Uncrated Dimensions(in.)			Shipping Weight (lbs.)	Sound PRESSURE Level**	MCA*	Max. Fuse*	Line Size (in)	
			W	D	H					OD Gas	OD Liq.
4TXU2018A10N0A	208/230/1/60	17,100	37.6	15.6	27.6	115.0	56	17	25	1/2	1/4
4TXU2024A10N0A	208/230/1/60	23,800	38.6	16.8	31.1	163.0	57	24	40	5/8	3/8
4TXU2030A10N0A	208/230/1/60	28,200	38.6	16.8	31.1	170.0	58	24	40	5/8	3/8
4TXU2036A10N0A	208/230/1/60	34,000	43.6	17.3	43.3	223.0	63	29	45	5/8	3/8
4TXU2042A10N0A	208/230/1/60	39,500	37.7	16.2	53.1	232.0	61	31	50	5/8	3/8
4TXU2048A10N0A	208/230/1/60	48,000	37.7	16.2	53.1	254.0	59	45	70	5/8	3/8

**Table DU-1-B — Up to 20 SEER R-410A Single Zone System Duct HP - Single Phase, 1-1/2 to 4 Ton<sup>①②</sup>**

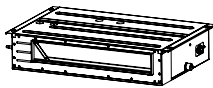

**4UXD20**

Outdoor Model Number Indoor Model Number	Power Supply	Nom. Cap. Cooling (BTUH)	Uncrated Dimensions(in.)			Shipping Weight (lbs.)	Sound PRESSURE Level**	MCA*	Max. Fuse*	Line Size (in)	
			W	D	H					OD Gas	OD Liq.
4UXD2018A10N0A	208/230/1/60	18,000	40.8	28.4	10.5	83.8	28-40			1/2	1/4
4UXD2024A10N0A	208/230/1/60	24,000	50.4	22.0	10.6	86.0	40-47			5/8	3/8
4UXD2030A10N0A	208/230/1/60	30,000	50.4	22.0	10.6	86.0	40-47			5/8	3/8
4UXD2036A10N0A	208/230/1/60	36,000	48.3	30.5	11.4	116.9	44-53			5/8	3/8
4UXD2042A10N0A	208/230/1/60	42,000	48.3	30.5	11.4	116.9	44-53			5/8	3/8
4UXD2048A10N0A	208/230/1/60	48,000	52.8	29.5	13.8	143.3	45-55			5/8	3/8

**Table DU-1-C — Up to 20 SEER R-410A Single Zone System Cassette HP - Single Phase, 1-1/2 to 4 Ton<sup>①②</sup>**

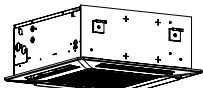

**4UXC20**

Outdoor Model Number Indoor Model Number	Power Supply	Nom. Cap. Cooling (BTUH)	Uncrated Dimensions(in.)			Shipping Weight (lbs.)	Sound PRESSURE Level**	MCA*	Max. Fuse*	Line Size (in)	
			W	D	H					OD Gas	OD Liq.
4UXC2018A10N0A	208/230/1/60	18,000	26.2	23.5	9.4	52.9	37-47			1/2	1/4
4UXC2024A10N0A	208/230/1/60	24,000	36.1	33.1	9.4	83.8	38-47			5/8	3/8
4UXC2030A10N0A	208/230/1/60	30,000	36.1	33.1	12.6	97.0	40-49			5/8	3/8
4UXC2036A10N0A	208/230/1/60	36,000	36.1	33.1	12.6	97.0	43-51			5/8	3/8
4UXC2042A10N0A	208/230/1/60	42,000	36.1	33.1	12.6	97.0	43-51			5/8	3/8
4UXC2048A10N0A	208/230/1/60	48,000	35.8	35.8	11.4	110.2	41-53			5/8	3/8

**Cassette Cover Panels** (must be ordered separately)

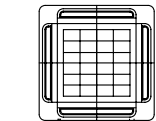

**4UXL20**

Model Number	Description	Matches Cassette HP Model(s)
4UXL2018A10N0A	Cover Panel 26.4x 26.4 x 2.0	4UXC2018A
4UXL2042A10N0A	Cover Panel 37.4 x 37.5 x 2.4	4UXC2024A - 4UXC2042A
4UXL2048A10N0A	Cover Panel 40.9 x 40.9 x 2.6	4UXC2048A

**Table DU-1-D — Up to 20 SEER R-410A Single Zone System Floor/Ceiling HP - Single Phase, 1-1/2 to 4 Ton<sup>①②</sup>**



**4UXX20**

Outdoor Model Number Indoor Model Number	Power Supply	Nom. Cap. Cooling (BTUH)	Uncrated Dimensions(in.)			Shipping Weight (lbs.)	Sound PRESSURE Level**	MCA*	Max. Fuse*	Line Size (in)	
			W	D	H					OD Gas	OD Liq.
4UXX2018A10N0A	208/230/1/60	18,000	48.0	27.6	8.9	105.8	32-44			1/2	1/4
4UXX2024A10N0A	208/230/1/60	24,000	48.0	27.6	8.9	110.3	40-49			5/8	3/8
4UXX2030A10N0A	208/230/1/60	30,000	55.9	27.6	9.6	123.5	38-49			5/8	3/8
4UXX2036A10N0A	208/230/1/60	36,000	55.9	27.6	9.6	123.5	46-54			5/8	3/8
4UXX2042A10N0A	208/230/1/60	42,000	55.9	27.6	9.6	127.9	47-55			5/8	3/8
4UXX2048A10N0A	208/230/1/60	48,000	66.9	27.6	9.6	149.9	46-56			5/8	3/8

① See AHRI for approved combinations and ratings.

② Outdoor unit must be matched with one of the three corresponding indoor units listed. These are one-to-one matched systems.

\* Information subject to change. Please confirm with current Product Data/Service Facts for current factory production.

\*\* Sound PRESSURE Level @ 3.3 ft. dB (A)



# Ductless Single Zone System Pro Series Single Phase – 1-1/2-4 Tons

**Table DU-2-A — Features**

	4TXU20 Single Zone up to 20 SEER
• R410-A refrigerant.....	✓
• Nominal capacity 18-48 MBH .....	✓
• Cooling efficiency up to 20 SEER .....	✓
• Heating efficiency range 9-10 HSPF.....	✓
• Heat Pump .....	✓
• Low sound level.....	✓
• Blue fin anti-corrosion treatment.....	✓
• ETL and AHRI listed.....	✓
• Sleep mode function .....	✓
• Memory reset function .....	✓
• Low ambient heating and cooling to 0 degrees F .....	✓
• Improved air quality with active carbon and catechin filters.....	✓
• <b>Registered limited warranty 5-year on all other functional parts (Residential Use)</b> ①.....	✓
• <b>Optional extended warranties available</b> .....	✓

① Registered Limited Warranty terms are available when you register within 60 days of installation. You can register online at americanstandardair.com or by phone at 800-554-8005; otherwise American Standard Heating & Air Conditioning's Base Limited Warranty terms will apply. Base Limited Warranty information on specific products can be found on ASDealerNet.com.

**See the Service First Mini-Split Accessory Catalog for the complete accessory list.**

**Table DU-2-B — Optional outdoor unit accessories**

Model Number	Description	4TXU20 Single Zone up to 20 SEER
TAYREFLN560 .....	Lineset Kit 1/4 x 1/2 - 25' .....	✓
TAYREFLN565 .....	Lineset Kit 1/4 x 1/2 - 35' .....	✓
TAYREFLN570 .....	Lineset Kit 1/4 x 1/2 - 50' .....	✓
TAYREFLN955 .....	Lineset Kit 3/8 x 5/8 - 25' .....	✓
TAYREFLN960 .....	Lineset Kit 3/8 x 5/8 - 35' .....	✓
TAYREFLN965 .....	Lineset Kit 3/8 x 5/8 - 50' .....	✓
TAYREFLN970 .....	Lineset Kit 3/8 x 5/8 - 100' .....	✓

**Table DU-2-C — Optional indoor unit accessories**

Model Number	Description	4UXD20 Single Zone Indoor up to 20 SEER	4UXC20 Single Zone Indoor up to 20 SEER	4UXX20 Single Zone Indoor up to 20 SEER
AREMOTE2AHANDAA .....	Wireless controller.....	✓	✓	✓
AREWIRE2AHANDAA .....	Wired controller (shipped with, noted here for reorder reference).....	✓	✓	✓
APROWIREAHANDAA .....	Programmable Wired controller.....	✓	✓	✓

Ductless

# Ductless Single Zone System Single Phase – 3/4-3 Tons

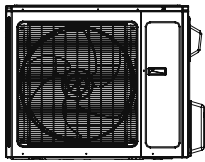

4TXK27



4MXW27

**Table DU-3-A — Up to 27 SEER R-410A Single Zone System HP — Single Phase, 3/4 to 2 Ton<sup>①</sup>**

Outdoor Model Number Indoor Model Number	Power Supply	Nom. Cap. Cooling (BTUH)	Uncrated Dimensions(in.)			Shipping Weight (lbs.)	Sound PRESSURE Level**	MCA*	Max. Fuse*	Line Size (in)	
			W	D	H					OD Gas	OD Liq.
4TXK2709A10N0A 4MXW2709A10N0A	208/230/1/60	9,000	35.4	14.9	23.5	91.5	49	10	15	1/2	1/4
4TXK2712A10N0A 4MXW2712A10N0A	208/230/1/60	12,000	34.1	8.2	11.5	30.9	23-42			1/2	1/4
4TXK2718A10N0A 4MXW2718A10N0A	208/230/1/60	18,000	37.6	15.6	27.6	119.0	56	15	20	5/8	1/4
4TXK2724A10N0A 4MXW2724A10N0A	208/230/1/60	24,000	40.0	9.1	12.6	38.6	33-51			5/8	1/4
4TXK2724A10N0A 4MXW2724A10N0A	208/230/1/60	24,000	38.6	16.8	31.1	165.3	59	20	30	5/8	1/4
4TXK2724A10N0A 4MXW2724A10N0A	208/230/1/60	24,000	46.4	10.4	12.8	47.4	38-52			5/8	1/4

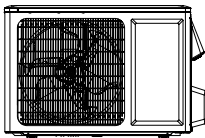

4TXK22



4MXW22

**Table DU-3-B — 115V Up to 22 SEER R-410A Single Zone System HP — Single Phase, 3/4 to 1 Ton<sup>①</sup>**

Outdoor Model Number Indoor Model Number	Power Supply	Nom. Cap. Cooling (BTUH)	Uncrated Dimensions(in.)			Shipping Weight (lbs.)	Sound PRESSURE Level**	MCA*	Max. Fuse*	Line Size (in)	
			W	D	H					OD Gas	OD Liq.
4TXK2209AL0N0A 4MXW2209AL0N0A	115/1/60	9,000	33.4	12.6	21.3	82.7	52	20	35	3/8	1/4
4TXK2212AL0N0A 4MXW2212AL0N0A	115/1/60	12,000	33.3	7.1	10.8	27.6	32-40			3/8	1/4
4TXK2218AL0N0A 4MXW2218AL0N0A	115/1/60	18,000	33.4	12.6	21.3	84.9	52	20	35	3/8	1/4
4TXK2224AL0N0A 4MXW2224AL0N0A	115/1/60	24,000	33.6	7.1	10.8	27.6	33-42			3/8	1/4

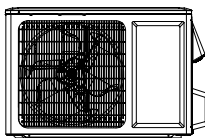

4TXK85

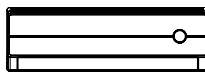

4MXW85

**Table DU-3-C — 18 SEER R-410A Single Zone System HP — Single Phase, 3/4 to 3 Ton<sup>①</sup>**

Outdoor Model Number Indoor Model Number	Power Supply	Nom. Cap. Cooling (BTUH)	Uncrated Dimensions(in.)			Shipping Weight (lbs.)	Sound PRESSURE Level**	MCA*	Max. Fuse*	Line Size (in)	
			W	D	H					OD Gas	OD Liq.
4TXK8509A10N0B 4MXW8509A10N0C	208/230/1/60	9,000	33.4	12.6	21.3	90.3	50	10	15	3/8	1/4
4TXK8512A10N0B 4MXW8512A10N0C	208/230/1/60	12,000	33.3	7.1	10.8	28.6	32-42			3/8	1/4
4TXK8518A10N0B 4MXW8518A10N0C	208/230/1/60	18,000	37.6	15.6	27.6	110.1	55	16	20	1/2	1/4
4TXK8524A10N0B 4MXW8524A10N0C	208/230/1/60	24,000	37.7	7.9	11.7	37.4	35-44			3/8	1/4
4TXK8524A10N0C 4MXW8524A10N0C	208/230/1/60	21,400	38.6	16.8	31.1	145.3	58	16	20	5/8	1/4
4TXK8536A10N0B <sup>②</sup> 4MXW8536A10N0C <sup>②</sup>	208/230/1/60	33,600	39.6	8.6	12.4	46.2	37-53			5/8	1/4
4TXK8536A10N0C <sup>②</sup> 4MXW8536A10N0C <sup>②</sup>	208/230/1/60	33,600	38.6	16.8	31.1	170	65	23	35	5/8	1/4
4TXK8536A10N0C <sup>②</sup> 4MXW8536A10N0C <sup>②</sup>	208/230/1/60	33,600	53.1	10	12.8	59.5	53-59			5/8	1/4

① See AHRI for approved combinations and ratings.

② Rated at 16 SEER

\* Information subject to change. Please confirm with current Product Data/Service Facts for current factory production.

\*\* Sound PRESSURE Level @3.3 ft. dB (A)

# Ductless Single Zone System Single Phase – 3/4-3 Tons

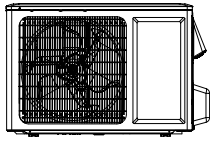

4TXK16



4MXW16

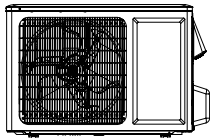

4TYK16



4MYW16

**Table DU-4-A — 16 SEER R-410A Single Zone System HP — Single Phase, 3/4 to 2 Ton<sup>①</sup>**

Outdoor Model Number Indoor Model Number	Power Supply	Nom. Cap. Cooling (BTUH)	Uncrated Dimensions(in.)			Shipping Weight (lbs.)	Sound PRESSURE Level**	MCA*	Max. Fuse*	Line Size (in)	
			W	D	H					OD Gas	OD Liq.
4TXK1609A10N0A	208/230/1/60	9,000	30.6	12.6	21.3	70.6	52	9	15	3/8	1/4
4MXW1609A10N0A	208/230/1/60		31.1	7.9	10.8	24.3	28-43			3/8	1/4
4TXK1612A10N0A	208/230/1/60	12,000	30.6	12.6	21.3	75	53	9	15	3/8	1/4
4MXW1612A10N0A	208/230/1/60		33.3	8.2	11.4	28.7	29-45			3/8	1/4
4TXK1618A10N0A	208/230/1/60	18,000	37.6	15.6	27.6	105.8	56	16	25	1/2	1/4
4MXW1618A10N0A	208/230/1/60		38.2	8.8	11.8	36.4	35-46			1/2	1/4
4TXK1624A10N0A	208/230/1/60	22,000	37.6	15.6	27.6	120.2	59	16	25	5/8	1/4
4MXW1624A10N0A	208/230/1/60		42.4	9.7	12.8	45.2	36-48			5/8	1/4

**Table DU-4-B — 16 SEER R-410A Single Zone System AC — Single Phase, 3/4 to 2 Ton<sup>①</sup>**

Outdoor Model Number Indoor Model Number	Power Supply	Nom. Cap. Cooling (BTUH)	Uncrated Dimensions(in.)			Shipping Weight (lbs.)	Sound PRESSURE Level**	MCA*	Max. Fuse*	Line Size (in)	
			W	D	H					OD Gas	OD Liq.
4TYK1609A10N0A	208/230/1/60	9,000	30.6	12.6	21.3	71.7	52	9	15	3/8	1/4
4MYW1609A10N0A	208/230/1/60		31.1	7.9	10.8	24.3	28-43			3/8	1/4
4TYK1612A10N0A	208/230/1/60	12,000	30.6	12.6	21.3	76.1	53	9	15	3/8	1/4
4MYW1612A10N0A	208/230/1/60		33.3	8.2	11.4	28.7	29-45			3/8	1/4
4TYK1618A10N0A	208/230/1/60	18,000	37.6	15.6	27.6	100.3	56	16	25	1/2	1/4
4MYW1618A10N0A	208/230/1/60		38.2	8.8	11.8	36.4	35-46			1/2	1/4
4TYK1624A10N0A	208/230/1/60	22,000	37.6	15.6	27.6	113.6	59	15	25	5/8	1/4
4MYW1624A10N0A	208/230/1/60		42.4	9.7	12.8	45.2	36-48			5/8	1/4

**Table DU-4-C — 16 SEER R-410A Single Zone System HP — Single Phase, 3/4 to 2 Ton<sup>①</sup>**

Outdoor Model Number Indoor Model Number	Power Supply	Nom. Cap. Cooling (BTUH)	Uncrated Dimensions(in.)			Shipping Weight (lbs.)	Sound PRESSURE Level**	MCA*	Max. Fuse*	Line Size (in)	
			W	D	H					OD Gas	OD Liq.
4TXK6509A10N0B	208/230/1/60	9,000	27.9	12.5	21.7	72.7	49	10	15	3/8	1/4
4MXW6509A10N0B	208/230/1/60		30.3	7.9	11.1	25.3	26-43			3/8	1/4
4TXK6512A10N0B	208/230/1/60	12,000	27.9	12.5	21.7	77.1	52	10	15	3/8	1/4
4MXW6512A10N0B	208/230/1/60		30.3	7.9	11.1	26.4	28-44			3/8	1/4
4TXK6518A10N0B	208/230/1/60	18,000	37.6	15.6	27.6	114.5	56	15	25	1/2	1/4
4MXW6518A10N0B	208/230/1/60		34.1	8.5	12	35.2	33-48			1/2	1/4
4TXK6524A10N0B	208/230/1/60	22,000	37.6	15.6	27.6	125.5	46	16	25	1/2	1/4
4MXW6524A10N0B	208/230/1/60		39.7	8.7	12.4	44	34-49			1/2	1/4

**Table DU-4-D — 16 SEER R-410A Single Zone System AC — Single Phase, 3/4 to 2 Ton<sup>①</sup>**

Outdoor Model Number Indoor Model Number	Power Supply	Nom. Cap. Cooling (BTUH)	Uncrated Dimensions(in.)			Shipping Weight (lbs.)	Sound PRESSURE Level**	MCA*	Max. Fuse*	Line Size (in)	
			W	D	H					OD Gas	OD Liq.
4TYK6509A10N0B	208/230/1/60	9,000	27.9	12.5	21.7	72.7	49	10	15	3/8	1/4
4MYW6509A10N0B	208/230/1/60		30.3	7.9	11.1	25.3	26-43			3/8	1/4
4TYK6512A10N0B	208/230/1/60	12,000	27.9	12.5	21.7	77.1	52	10	15	3/8	1/4
4MYW6512A10N0B	208/230/1/60		30.3	7.9	11.1	26.4	28-44			3/8	1/4
4TYK6518A10N0B	208/230/1/60	18,000	37.6	15.6	27.6	114.5	56	15	25	1/2	1/4
4MYW6518A10N0B	208/230/1/60		34.1	8.5	12	35.2	33-48			1/2	1/4
4TYK6524A10N0B	208/230/1/60	22,000	37.6	15.6	27.6	123.3	56	16	25	1/2	1/4
4MYW6524A10N0B	208/230/1/60		39.7	8.7	12.4	44	34-49			1/2	1/4

① See AHRI for approved combinations and ratings.

\* Information subject to change. Please confirm with current Product Data/Service Facts for current factory production.

\*\* Sound PRESSURE Level @3.3 ft. dB (A)

Ductless

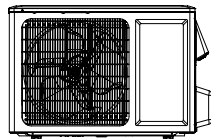

4TYK65



4MYW65

For complete equipment / combination selections, installation instructions and warranty information, please refer to Product Data/Ratings and/or Installers Guides and Limited Warranty Handbooks.

# Ductless Single-Zone Units

**Table DU-5-A — Features**

	4TXK27 Single Zone HP up to 27 SEER	4TXK85 Single Zone HP 18 SEER	4TXK16 & 65 Single Zone HP 16 SEER	4TYK16 & 65 Single Zone AC 16 SEER
• R410-A refrigerant.....	✓	✓	✓	✓
• Nominal capacity 9-24 MBH.....	✓	—	✓	✓
• Nominal capacity 9-36 MBH.....	—	✓	—	—
• Cooling efficiency 16 SEER.....	—	—	✓	✓
• Cooling efficiency range 16-22 SEER.....	—	✓	—	—
• Cooling efficiency range up to 27 SEER.....	✓	—	—	—
• Heating efficiency range 8-8.5 HSPF.....	—	—	4TXK65 only	—
• Heating efficiency range 8.2-10 HSPF.....	✓	✓	4TXK16 only	—
• Heat Pump.....	✓	✓	✓	—
• Cooling only.....	—	—	—	✓
• Low sound level.....	✓	✓	✓	✓
• Blue fin anti-corrosion treatment.....	✓	✓	✓	✓
• Energy Star qualified.....	✓	—	—	—
• ETL and AHRI listed.....	✓	✓	✓	✓
• Sleep mode function.....	✓	✓	✓	✓
• Memory reset function.....	✓	✓	✓	✓
• Low ambient cooling to 0 degrees F.....	✓	✓	✓	✓
• Low ambient heating to -4 degrees F.....	✓	—	4TXK16 only	—
• Low ambient heating to 5 degrees F.....	—	✓	4TXK65 only	—
• Improved air quality with active carbon and catechin filters.....	✓	✓	✓	✓
• <b>Registered limited warranty 5-year on all other functional parts (Residential Use)</b> ①.....	✓	✓	✓	✓
• <b>Optional extended warranties available</b> .....	✓	✓	✓	✓

① Registered Limited Warranty terms are available when you register within 60 days of installation. You can register online at americanstandardair.com or by phone at 800-554-8005; otherwise American Standard Heating & Air Conditioning's Base Limited Warranty terms will apply. Base Limited Warranty information on specific products can be found on ASDealerNet.com.

See the Service First Accessory Catalog for the complete accessory list.

**Table DU-5-B — Optional outdoor unit accessories**

Model Number	Description	4TXK27 Single Zone HP up to 27 SEER	4TXK85 Single Zone HP 18 SEER	4TXK16 & 65 Single Zone HP 16 SEER	4TYK16 & 65 Single Zone AC 16 SEER
TAYREFLN050.....	Lineset Kit 1/4 x 3/8 - 25'.....	—	✓	✓	✓
TAYREFLN055.....	Lineset Kit 1/4 x 3/8 - 35'.....	—	✓	✓	✓
TAYREFLN060.....	Lineset Kit 1/4 x 3/8 - 50'.....	—	✓	✓	✓
TAYREFLN560.....	Lineset Kit 1/4 x 1/2 - 25'.....	✓	✓	✓	✓
TAYREFLN565.....	Lineset Kit 1/4 x 1/2 - 35'.....	✓	✓	✓	✓
TAYREFLN570.....	Lineset Kit 1/4 x 1/2 - 50'.....	✓	✓	✓	✓
TAYREFLN155.....	Lineset Kit 1/4 x 5/8 - 25'.....	✓	—	—	—
TAYREFLN160.....	Lineset Kit 1/4 x 5/8 - 35'.....	✓	—	—	—
TAYREFLN165.....	Lineset Kit 1/4 x 5/8 - 50'.....	✓	—	—	—

**Table DU-5-C — Optional indoor unit accessories**

Model Number	Description	4MXW85 & 27 Single Zone Indoor 18 & 27 SEER	4MXW16 & 65 Single Zone Indoor 16 SEER	4MYW16 & 65 Single Zone Indoor 16 SEER
BAYFTHW01P2A.....	Active Carbon & Catechin filters (9 & 12 MBH) 16 SEER units.....	—	✓	✓
BAYFTHW02P2A.....	Active Carbon & Catechin filters (18 & 24 MBH) 16 SEER units and ..... 9, 12, 18 & 24 MBH 18 & 27 SEER units.....	✓	✓	✓
BAYFTHW03P2A.....	Active Carbon & Catechin filters for 36 MBH 18 & 27 SEER units.....	✓	✓	✓
AREMOTE2AHANDAA ...	Wireless controller.....	✓	✓	✓
AREWIRE1AHANDAA ....	Wired Controller (not compatible with 4MXW85 14th digit B models).....	✓	4MXW16	4MYW16

For complete equipment / combination selections, installation instructions and warranty information, please refer to Product Data/Ratings and/or Installers Guides and Limited Warranty Handbooks.

# Ductless Multi-Zone System Single Phase – 1½ - 3½ Tons

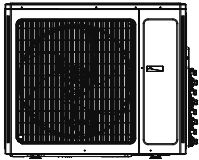

4TXM22

**Table DU-6-A — R-410A Up to 22 SEER Multi-Zone System HP — Single Phase, 1-1/2 to 3-1/2 Ton** ①②③

Outdoor Model Number	Power Supply	Nom. Cap. Cooling (BTUH)	Uncrated Dimensions(in.)			Shipping Weight (lbs.)	Sound PRESSURE Level**	MCA*	Fuse*	Line Size (in)		No of Circuits
			W	D	H				Max. OD Gas	OD Liq.		
4TXM2218A1020A	208/230/1/60	18,000	37.6	15.6	27.6	124.6	55	15	25	3/8	1/4	2
4TXM2221A1030A	208/230/1/60	21,000	38.6	16.8	31.1	164.3	59	21	30	3/8	1/4	3
4TXM2224A1040A	208/230/1/60	24,000	38.6	17.3	31.1	167.6	59	19	30	3/8	1/4	4
4TXM2230A1050A	208/230/1/60	30,000	42.8	17.3	43.4	216.1	61	24	35	3/8	1/4	5
4TXM2236A1050A	208/230/1/60	34,000	42.8	17.3	43.4	216.1	61	24	35	3/8	1/4	5
4TXM2242A1050A	208/230/1/60	42,000	42.8	17.3	43.4	216.1	61	24	35	3/8	1/4	5

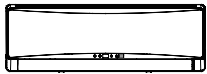

4MXW27

**Table DU-6-B — R-410A Multi-Zone High Wall System HP — Single Phase** ①

Outdoor Model Number	Power Supply	Nom. Cap. Cooling (BTUH)	Uncrated Dimensions(in.)			Shipping Weight (lbs.)	Sound PRESSURE Level**	MCA*	Fuse*	Line Size (in)	
Indoor Model Number			W	D	H				Max. OD Gas	OD Liq.	
4MXW2709A10N0A	208/230/1/60	9,000	34.1	8.2	11.5	30.9	23-42			1/2	1/4
4MXW2712A10N0A	208/230/1/60	12,000	34.1	8.2	11.5	30.9	24-44			1/2	1/4
4MXW2718A10N0A	208/230/1/60	18,000	40.0	9.1	12.6	38.6	33-51			5/8	1/4
4MXW2724A10N0A	208/230/1/60	24,000	46.4	10.4	12.8	47.4	38-52			5/8	1/4



4MXW85

**Table DU-6-C — R-410A Multi-Zone High Wall System HP — Single Phase** ①

Indoor Model Number ④	Power Supply	Nom. Cap. Cooling (BTUH)	Uncrated Dimensions(in.)			Shipping Weight (lbs.)	Sound PRESSURE Level**	MCA*	Fuse*	Line Size (in)	
			W	D	H				Max. OD Gas	OD Liq.	
4MXW8509A10N0C	208/230/1/60	9,000	33.3	7.1	10.8	28.6	32-42			3/8	1/4
4MXW8512A10N0C	208/230/1/60	12,000	33.3	7.1	10.8	28.6	33-44			3/8	1/4
4MXW8518A10N0C	208/230/1/60	18,000	37	7.9	11.7	37.4	35-49			1/2	1/4
4MXW8524A10N0C	208/230/1/60	24,000	39.6	8.6	12.4	46.2	37-53			5/8	1/4

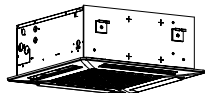

4MXC85

**Table DU-6-D — R-410A Multi-Zone System Cassette HP — Single Phase** ①

Indoor Model Number	Power Supply	Nom. Cap. Cooling (BTUH)	Uncrated Dimensions(in.)			Shipping Weight (lbs.)	Sound PRESSURE Level**	MCA*	Fuse*	Line Size (in)	
			W	D	H				Max. OD Gas	OD Liq.	
4MXC8512A10N0A	208/230/1/60	12,000	22.4	22.4	9.1	50.7	37-46			3/8	1/4
4MXC8518A10N0A	208/230/1/60	14,400	22.4	22.4	9.1	50.7	37-46			1/2	1/4
4MXC8524A10N0A	208/230/1/60	22,800	33.1	33.1	9.5	83.8	35-39			5/8	3/8

**Cassette Cover Panels** (must be ordered separately)

Model Number	Description	Matches Cassette HP Model(s)
4MXL8518A10N0A	..... Cover Panel 25.59 x 25.59 x 1.97	..... 4MXC8512 & 4MXC8518
4MXL8524A10N0A	..... Cover Panel 37.40 x 37.40 x 2.36	..... 4MXC8524

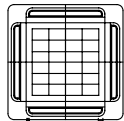

4MXL85

**Table DU-6-E — R-410A Multi-Zone System Console HP — Single Phase** ①

Indoor Model Number	Power Supply	Nom. Cap. Cooling (BTUH)	Uncrated Dimensions(in.)			Shipping Weight (lbs.)	Sound PRESSURE Level**	MCA*	Fuse*	Line Size (in)	
			W	D	H				Max. OD Gas	OD Liq.	
4MXF8509A10N0A	208/230/1/60	9,000	27.6	23.6	8.5	39.7	25-36			3/8	1/4
4MXF8512A10N0A	208/230/1/60	12,000	27.6	23.6	8.5	39.7	27-38			3/8	1/4
4MXF8518A10N0A	208/230/1/60	18,000	27.6	23.6	8.5	39.7	33-44			1/2	1/4

① See AHRI for allowable combinations and ratings.

② Because of limited capabilities, please refer to the product ratings for approved combinations.

③ Capacity varies depending on the indoor unit matches.

④ 4MXW85 High Wall Models with 14th digit C models are compatible with wired controller

\* Information subject to change. Please confirm with current Product Data/Service Facts for current factory production.

\*\* Sound PRESSURE Level @3.3 ft. dB (A)

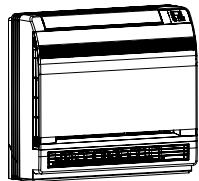

4MXF85

Ductless

# Ductless Multi-Zone System Single Phase – 1-1/2 - 3-1/2 Tons



4MXD85



4MXX85

**Table DU-7-A — R-410A Multi-Zone System Ceiling Concealed HP — Single Phase<sup>②</sup>**

Indoor Model Number	Power Supply	Nom. Cap. Cooling (BTUH)	Uncrated Dimensions(in.)			Shipping Weight (lbs.)	Sound PRESSURE Level**	MCA*	Max. Fuse*	Line Size (in)	
			W	D	H					OD Gas	OD Liq.
4MXD8509A10N0A	208/230/1/60	8,500	27.6	24.2	7.9	59.5	19-27			3/8	1/4
4MXD8512A10N0A	208/230/1/60	11,900	27.6	24.2	7.9	63.9	30-39			3/8	1/4
4MXD8518A10N0A	208/230/1/60	15,300	35.4	24.2	7.9	79.4	30-41			1/2	1/4
4MXD8521A10N0A	208/230/1/60	20,400	43.3	24.2	7.9	90.4	32-42			5/8	3/8
4MXD8524A10N0A	208/230/1/60	23,800	43.3	24.2	7.9	90.4	32-42			5/8	3/8

**Table DU-7-B — R-410A Multi-Zone System Floor/Ceiling HP — Single Phase<sup>②</sup>**

Indoor Model Number	Power Supply	Nom. Cap. Cooling (BTUH)	Uncrated Dimensions(in.)			Shipping Weight (lbs.)	Sound PRESSURE Level**	MCA*	Max. Fuse*	Line Size (in)	
			W	D	H					OD Gas	OD Liq.
4MXX8509A10N0A	208/230/1/60	8,500	48.0	27.6	8.9	110.2	33-40			3/8	1/4
4MXX8512A10N0A	208/230/1/60	11,900	48.0	27.6	8.9	110.2	33-40			3/8	1/4
4MXX8518A10N0A	208/230/1/60	17,000	48.0	27.6	8.9	110.2	38-45			1/2	1/4
4MXX8524A10N0A	208/230/1/60	22,800	48.0	27.6	8.9	119	29-48			5/8	3/8

- ① Units are matched with 4MXW85 indoor units.
- ② See AHRI for allowable combinations and ratings.
- ③ Because of limited capabilities, please refer to the product ratings for approved combinations.
- ④ Capacity varies depending on the indoor unit matches.
- ⑤ Includes two 3/8 x 1/4 circuits, two 1/2 x 1/4 circuits, and one 5/8 x 3/8 circuit.
- ⑥ Includes two 3/8 x 1/4 circuits, one 1/2 x 1/4 circuits, and one 5/8 x 3/8 circuit.
- ⑦ 4MXW85 High Wall Models with 14th digit C models are now compatible with wired controller
- \* Information subject to change. Please confirm with current Product Data/Service Facts for current factory production.
- \*\* Sound PRESSURE Level @3.3 ft. dB (A)

# Ductless Multi-Zone System Single Phase – 1-1/2 - 3-1/2 Tons

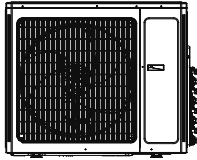

4TXM65

**Table DU-8-A — R-410A 16 SEER Multi-Zone System HP — Single Phase<sup>①②③</sup>**

Outdoor Model Number	Power Supply	Nom. Cap. Cooling (BTUH)	Uncrated Dimensions (in.)			Shipping Weight (lbs.)	Sound PRESSURE Level**	MCA*	Max. Fuse*	Line Size (in)		No of Circuits
			W	D	H					OD Gas	OD Liq.	
4TXM6518A1020B	208/230/1/60	18,000	35.4	14.9	23.5	105.6	56	15	20	3/8	1/4	2
4TXM6524A1030B	208/230/1/60	24,000	37.2	15.6	27.6	145.2	59	20	30	3/8	1/4	3
4TXM6530A1040B	208/230/1/60	30,000	37.2	15.6	27.6	147.4	59	26	45	3/8	1/4	4
4TXM6536A1040B	208/230/1/60	34,000	36.2	16.8	31.1	164.9	59	28	45	3/8	1/4	4 ⑥
4TXM6542A1050B	208/230/1/60	42,000	40.0	17.3	43.4	246.4	58	26	40	3/8	1/4	5 ⑤

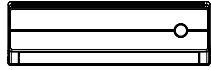

4MXW85

**Table DU-8-B — R-410A Multi-Zone High Wall System HP — Single Phase<sup>②</sup>**

Indoor Model Number ⑦	Power Supply	Nom. Cap. Cooling (BTUH)	Uncrated Dimensions (in.)			Shipping Weight (lbs.)	Sound PRESSURE Level**	MCA*	Max. Fuse*	Line Size (in)	
			W	D	H					OD Gas	OD Liq.
4MXW8509A10N0C	208/230/1/60	9,000	33.3	7.1	10.8	28.6	32-42			3/8	1/4
4MXW8512A10N0C	208/230/1/60	12,000	33.3	7.1	10.8	28.6	33-44			3/8	1/4
4MXW8518A10N0C	208/230/1/60	18,000	37	7.9	11.7	37.4	35-49			1/2	1/4
4MXW8524A10N0C	208/230/1/60	24,000	39.6	8.6	12.4	46.2	37-53			5/8	1/4

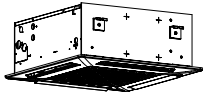

4MXC85

**Table DU-8-C — R-410A Multi-Zone System Cassette HP — Single Phase<sup>②</sup>**

Indoor Model Number	Power Supply	Nom. Cap. Cooling (BTUH)	Uncrated Dimensions (in.)			Shipping Weight (lbs.)	Sound PRESSURE Level**	MCA*	Max. Fuse*	Line Size (in)	
			W	D	H					OD Gas	OD Liq.
4MXC8512A10N0A	208/230/1/60	12,000	22.4	22.4	9.1	50.7	37-46			3/8	1/4
4MXC8518A10N0A	208/230/1/60	14,400	22.4	22.4	9.1	50.7	37-46			1/2	1/4
4MXC8524A10N0A	208/230/1/60	22,800	33.1	33.1	9.5	83.8	35-39			5/8	3/8

**Cassette Cover Panels** (must be ordered separately)

Model Number	Description	Matches Cassette HP Model(s)
4MXL8518A10N0A	..... Cover Panel 25.59 x 25.59 x 1.97 .....	4MXC8512 & 4MXC8518
4MXL8524A10N0A	..... Cover Panel 37.40 x 37.40 x 2.36 .....	4MXC8524

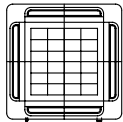

4MXL85

**Table DU-8-D — R-410A Multi-Zone System Console HP — Single Phase<sup>②</sup>**

Indoor Model Number	Power Supply	Nom. Cap. Cooling (BTUH)	Uncrated Dimensions (in.)			Shipping Weight (lbs.)	Sound PRESSURE Level**	MCA*	Max. Fuse*	Line Size (in)	
			W	D	H					OD Gas	OD Liq.
4MXF8509A10N0A	208/230/1/60	9,000	27.6	23.6	8.5	39.7	25-36			3/8	1/4
4MXF8512A10N0A	208/230/1/60	12,000	27.6	23.6	8.5	39.7	27-38			3/8	1/4
4MXF8518A10N0A	208/230/1/60	18,000	27.6	23.6	8.5	39.7	33-44			1/2	1/4

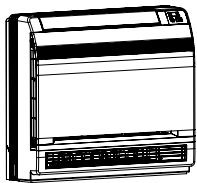

4MXF85

**Table DU-8-E — R-410A Multi-Zone System Ceiling Concealed HP — Single Phase<sup>②</sup>**

Indoor Model Number	Power Supply	Nom. Cap. Cooling (BTUH)	Uncrated Dimensions (in.)			Shipping Weight (lbs.)	Sound PRESSURE Level**	MCA*	Max. Fuse*	Line Size (in)	
			W	D	H					OD Gas	OD Liq.
4MXD8509A10N0A	208/230/1/60	8,500	27.6	24.2	7.9	59.5	19-27			3/8	1/4
4MXD8512A10N0A	208/230/1/60	11,900	27.6	24.2	7.9	63.9	30-39			3/8	1/4
4MXD8518A10N0A	208/230/1/60	15,300	35.4	24.2	7.9	79.4	30-41			1/2	1/4
4MXD8521A10N0A	208/230/1/60	20,400	43.3	24.2	7.9	90.4	32-42			5/8	3/8
4MXD8524A10N0A	208/230/1/60	23,800	43.3	24.2	7.9	90.4	32-42			5/8	3/8



4MXD85

**Table DU-8-F — R-410A Multi-Zone System Floor/Ceiling HP — Single Phase<sup>②</sup>**

Indoor Model Number	Power Supply	Nom. Cap. Cooling (BTUH)	Uncrated Dimensions (in.)			Shipping Weight (lbs.)	Sound PRESSURE Level**	MCA*	Max. Fuse*	Line Size (in)	
			W	D	H					OD Gas	OD Liq.
4MXX8509A10N0A	208/230/1/60	8,500	48.0	27.6	8.9	110.2	33-40			3/8	1/4
4MXX8512A10N0A	208/230/1/60	11,900	48.0	27.6	8.9	110.2	33-40			3/8	1/4
4MXX8518A10N0A	208/230/1/60	17,000	48.0	27.6	8.9	110.2	38-45			1/2	1/4
4MXX8524A10N0A	208/230/1/60	22,800	48.0	27.6	8.9	119	29-48			5/8	3/8



4MXX85

① Units are matched with 4MXW85 indoor units.  
 ② See AHRI for allowable combinations and ratings.  
 ③ Because of limited capabilities, please refer to the product ratings for approved combinations.  
 ④ Capacity varies depending on the indoor unit matches.  
 ⑤ Includes two 3/8 x 1/4 circuits, two 1/2 x 1/4 circuits, and one 5/8 x 3/8 circuit.  
 ⑥ Includes two 3/8 x 1/4 circuits, one 1/2 x 1/4 circuits, and one 5/8 x 3/8 circuit.  
 ⑦ 4MXW85 High Wall Models with 14th digit C models are now compatible with wired controller  
 \* Information subject to change. Please confirm with current Product Data/Service Facts for current factory production.  
 \*\* Sound PRESSURE Level @3.3 ft. dB (A)

Ductless

For complete equipment / combination selections, installation instructions and warranty information, please refer to Product Data/Ratings and/or Installers Guides and Limited Warranty Handbooks.

# Ductless Multi-Zone Outdoor Unit

**Table DU-9-A — Features**

	4TXM22 Multi-split 22 SEER	4TXM65 Multi-split 16 SEER
• R410-A refrigerant.....	✓	✓
• Flexibility to accommodate to different applications.....	✓	✓
• Connect up to 5 indoor units to a single condensing unit.....	✓	✓
• Nominal capacity 18-42 MBH.....	✓	✓
• Cooling efficiency up to 22 SEER.....	✓	—
• Cooling efficiency of 16 SEER.....	—	✓
• Heating efficiency of 9-10.5 HSPF.....	✓	—
• Heating efficiency of 8.2 HSPF.....	—	✓
• Heat Pump.....	✓	✓
• Low sound level.....	✓	✓
• Blue fin anti-corrosion treatment.....	✓	✓
• ETL and AHRI listed.....	✓	✓
• Sleep mode function.....	✓	✓
• Memory reset function.....	✓	✓
• Low ambient cooling to 0 degrees F.....	✓	✓
• Low ambient heating to -4 degrees F.....	✓	—
• Low ambient heating to 5 degrees F.....	—	✓
• Improved air quality with active carbon and catechin filters.....	✓	✓
• <b>Registered limited warranty 5-year on all other functional parts (Residential Use)</b> ①.....	✓	✓
• <b>Optional extended warranties available</b> .....	✓	✓

① Registered Limited Warranty terms are available when you register within 60 days of installation. You can register online at americanstandardair.com or by phone at 800-554-8005; otherwise American Standard Heating & Air Conditioning's Base Limited Warranty terms will apply. Base Limited Warranty information on specific products can be found on ASDealerNet.com.

See the Service First Accessory Catalog for the complete accessory list.

**Table DU-9-B — Optional outdoor unit accessories**

Model Number	Description	4TXM22 Multi-split 22 SEER	4TXM65 Multi-split 16 SEER
TAYREFLN050.....	Lineset Kit 1/4 x 3/8 - 25'	✓	✓
TAYREFLN055.....	Lineset Kit 1/4 x 3/8 - 35'	✓	✓
TAYREFLN060.....	Lineset Kit 1/4 x 3/8 - 50'	✓	✓
TAYREFLN560.....	Lineset Kit 1/4 x 1/2 - 25'	—	✓
TAYREFLN565.....	Lineset Kit 1/4 x 1/2 - 35'	—	✓
TAYREFLN570.....	Lineset Kit 1/4 x 1/2 - 50'	—	✓
TAYREFLN155.....	Lineset Kit 1/4 x 5/8 - 25'	—	✓
TAYREFLN160.....	Lineset Kit 1/4 x 5/8 - 35'	—	✓
TAYREFLN165.....	Lineset Kit 1/4 x 5/8 - 50'	—	✓

Ductless



**Table DU-10-A — R-410A VRF Software**

VRF Select	PC Windows Based	Download from <a href="http://www.asdealernet.com">www.asdealernet.com</a>
Technician Utility Software	PC Windows Based	Download from <a href="http://www.asdealernet.com">www.asdealernet.com</a>

**Table DU-10-B — R-410A VRF Slim One-Way Cassette**

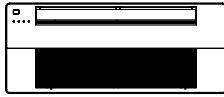

**4TVE00**

Indoor Model Number	Power Supply	Nom. Cap. Cooling (BTUH) ①	Uncrated Dimensions(in.)			Shipping Weight (lbs.)	Sound PRESSURE Level ②	MCA*	Max. Fuse*	Line Size (in)	
			W	D	H					OD Gas	OD Liq.
4TVE0007B100NB	208/230/1/60	7,500	38.2	16.2	5.3	29.8	23-27	0.29	15	1/2	1/4
4TVE0009B100NB	208/230/1/60	9,500	38.2	16.2	5.3	29.8	24-29	0.32	15	1/2	1/4
4TVE0012B100NB	208/230/1/60	12,000	38.2	16.2	5.3	29.8	27-35	0.35	15	1/2	1/4

**Cassette Cover Panels ③**

Model Number	Description	Matches Cassette HP Model(s)
TVEPANPC1NUSET	..... Cover Panel 46.5 x 18.2 x 1.0 .....	4TVE007B, 009B & 012B
TVEPANPC1NUAET	..... Cassette Panel Sliding one way 46.5 x 18.2 x 1.0	4TVE007B, 009B & 012B

**Table DU-10-C — R-410A VRF Mini Four-Way Cassette ④**

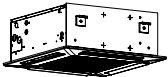

**4TVB00**

Indoor Model Number	Power Supply	Nom. Cap. Cooling (BTUH) ①	Uncrated Dimensions(in.)			Shipping Weight (lbs.)	Sound PRESSURE Level ②	MCA*	Max. Fuse*	Line Size (in)	
			W	D	H					OD Gas	OD Liq.
4TVB0009B100NB	208/230/1/60	9,500	22.8	22.8	9.8	30.9	26-34	0.22	15	1/2	1/4
4TVB0012B100NB	208/230/1/60	12,000	22.8	22.8	9.8	30.9	31-36	0.24	15	1/2	1/4
4TVB0018B100NB	208/230/1/60	18,000	22.8	22.8	9.8	30.9	34-40	0.34	15	1/2	1/4
4TVB0020B100NB	208/230/1/60	20,000	22.8	22.8	9.8	30.9	35-41	0.38	15	1/2	1/4

**Cassette Cover Panels ③**

Model Number	Description	Matches Cassette HP Model(s)
TVEPANPC4SUSSET	..... Cover Panel 26.4 x 26.4 x 1.97 .....	4TVB0009B - 4TVB0020B

**Table DU-10-D — R-410A VRF Four-Way Cassette**

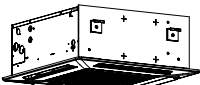

**4TVC00**

Indoor Model Number	Power Supply	Nom. Cap. Cooling (BTUH) ①	Uncrated Dimensions(in.)			Shipping Weight (lbs.)	Sound PRESSURE Level ②	MCA*	Max. Fuse*	Line Size (in)	
			W	D	H					OD Gas	OD Liq.
4TVC0009B100NB	208/230/1/60	9,000	33	33	8	40.8	31-34	0.32	15	1/2	1/4
4TVC0012B100NB	208/230/1/60	12,000	33	33	8	40.8	31-34	0.32	15	1/2	1/4
4TVC0018B100NB	208/230/1/60	18,000	33	33	8	40.8	31-34	0.32	15	1/2	1/4
4TVC0024B100NB	208/230/1/60	24,000	33	33	8	40.8	34-36	0.38	15	1/2	1/4
4TVC0030B100NB	208/230/1/60	30,000	33	33	11.3	50.7	30-39	0.63	15	5/8	3/8
4TVC0036B100NB	208/230/1/60	36,000	33	33	11.3	50.7	33-40	0.70	15	5/8	3/8
4TVC0048B100NB	208/230/1/60	48,000	33	33	11.3	50.7	39-44	0.94	15	5/8	3/8

**Cassette Cover Panels ③**

Model Number	Description	Matches Cassette HP Model(s)
TVEPANPC4NUSET	..... Cover Panel 37.4 x 37.4 x 1.8	4TVC009B, 0018B, 0024B, 0030B, 00036B & 0048B

**Table DU-10-E — R-410A VRF Slim Duct ⑤**



**4TVL00**

Indoor Model Number	Power Supply	Nom. Cap. Cooling (BTUH) ①	Uncrated Dimensions(in.)			Shipping Weight (lbs.)	Sound PRESSURE Level ②	MCA*	Max. Fuse*	Line Size (in)	
			W	D	H					OD Gas	OD Liq.
4TVL0007B100NB	208/230/1/60	7,500	35.4	23.6	7.8	62.8	21-26	0.40	15	1/2	1/4
4TVL0009B100NB	208/230/1/60	9,500	35.4	23.6	7.8	62.8	23-27	0.50	15	1/2	1/4
4TVL0012B100NB	208/230/1/60	12,000	35.4	23.6	7.8	62.8	27-29	0.64	15	1/2	1/4
4TVL0018B100NB	208/230/1/60	18,000	43.3	23.6	7.8	76.0	31-36	1.18	15	1/2	1/4
4TVL0024B100NB	208/230/1/60	24,000	43.3	23.6	7.8	76.0	33-38	1.23	15	5/8	3/8
4TVL0030B100NB	208/230/1/60	30,000	51.2	27.2	11.6	103.6	34-37	1.00	15	5/8	3/8
4TVL0036B100NB	208/230/1/60	36,000	51.2	27.2	11.6	103.6	34-37	1.32	15	5/8	3/8
4TVL0048B100NB	208/230/1/60	48,000	51.2	27.2	11.6	107.0	36-39	1.75	15	5/8	3/8

① Nominal capacity based on 25 ft. of equivalent refrigerant piping with 0 ft. level difference

- Cooling: Indoor temperature 80°F DB, 67°F WB/Outdoor temperature 95°F DB, 75°F WB

- Heating: Indoor temperature 70°F DB, 60°F WB/Outdoor temperature 47°F DB, 43°F WB

② Sound pressure was acquired in a dead room. Actual noise level may be different depending on installation conditions.

③ Cassette panel must be ordered separately.

④ Optional field installed motion detector sensor must be ordered separately.

⑤ Optional internal condensate drain pump must be ordered separately if gravity drain is not possible

\* Information subject to change. Please confirm with current Product Data for current factory production.

All VRF systems shall be selected using VRF Select software

Ductless

For complete equipment / combination selections, installation instructions and warranty information, please refer to Product Data/Ratings and/or Installers Guides and Limited Warranty Handbooks.

# American Standard AccuFlex™ VRF Indoor Units

**Table DU-11-A — R-410A VRF MSP (Middle Static Pressure) Duct** ③



**4TVD00-B**

Indoor Model Number	Power Supply	Nom. Cap. Cooling (BTUH) ①	Uncrated Dimensions(in.)			Shipping Weight (lbs.)	Sound PRESSURE Level ②	MCA*	Max. Fuse*	Line Size (in)	
			W	D	H					OD Gas	OD Liq.
4TVD0018B100NB	208/230/1/60	18,000	35.4	18.8	10.3	72.8	31-35	1.75	15	1/2	1/4
4TVD0024B100NB	208/230/1/60	24,000	35.4	18.8	10.3	72.8	31-39	1.88	15	5/8	3/8
4TVD0030B100NB	208/230/1/60	30,000	45.3	18.8	12.6	89.3	34-40	1.88	15	5/8	3/8
4TVD0036B100NB	208/230/1/60	36,000	45.3	18.8	12.6	89.3	38-41	2.00	15	5/8	3/8
4TVD0048B100NB	208/230/1/60	48,000	47.3	25.6	14.2	122.4	36-42	3.07	15	5/8	3/8

**Table DU-11-B — R-410A VRF MSP (Middle Static Pressure) Duct**



**4TVD00-C**

Indoor Model Number	Power Supply	Nom. Cap. Cooling (BTUH) ①	Uncrated Dimensions(in.)			Shipping Weight (lbs.)	Sound PRESSURE Level ②	MCA*	Max. Fuse*	Line Size (in)	
			W	D	H					OD Gas	OD Liq.
4TVD0007C100NB	208/230/1/60	7,500	45.3	18.9	12.6	103.6	26-36	1.10	15	1/2	1/4
4TVD0009C100NB	208/230/1/60	9,500	45.3	18.9	12.6	103.6	26-36	1.10	15	1/2	1/4
4TVD0012C100NB	208/230/1/60	12,000	45.3	18.9	12.6	103.6	30-39	1.10	15	1/2	1/4
4TVD0015C100NB	208/230/1/60	15,000	45.3	18.9	12.6	103.6	32-41	1.10	15	1/2	1/4
4TVD0018C100NB	208/230/1/60	18,000	45.3	18.9	12.6	103.6	35-42	1.10	15	1/2	1/4
4TVD0024C100NB	208/230/1/60	24,000	47.3	25.6	14.2	144.4	30-36	4.30	15	5/8	3/8
4TVD0027C100NB	208/230/1/60	27,000	47.3	25.6	14.2	144.4	30-38	4.30	15	5/8	3/8
4TVD0030C100NB	208/230/1/60	30,000	47.3	25.6	14.2	144.4	31-38	4.30	15	5/8	3/8
4TVD0036C100NB	208/230/1/60	36,000	47.3	25.6	14.2	148.8	35-41	4.30	15	5/8	3/8
4TVD0048C100NB	208/230/1/60	48,000	47.3	25.6	14.2	148.8	36-42	4.30	15	5/8	3/8

**Table DU-11-C — R-410A VRF HSP (High Static Pressure) Duct** ③



**4TVA00**

Indoor Model Number	Power Supply	Nom. Cap. Cooling (BTUH) ①	Uncrated Dimensions(in.)			Shipping Weight (lbs.)	Sound PRESSURE Level ②	MCA*	Max. Fuse*	Line Size (in)	
			W	D	H					OD Gas	OD Liq.
4TVA0036B100NB	208/230/1/60	36,000	47.2	25.6	14.2	138.9	37-40	1.59	15	5/8	3/8
4TVA0048B100NB	208/230/1/60	48,000	47.2	25.6	14.2	138.9	40-44	2.73	15	5/8	3/8
4TVA0076B100NB	208/230/1/60	76,000	48.8	40.9	18.5	218.3	41-45	4.75	15	3/4	3/8
4TVA0096B100NB	208/230/1/60	96,000	48.8	40.9	18.5	218.3	43-48	7.38	15	7/8	3/8

**Table DU-11-D — R-410A VRF Ceiling Suspended (Floor)** ⑤

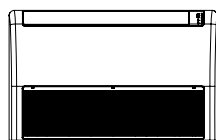

**4TVX00**

Indoor Model Number	Power Supply	Nom. Cap. Cooling (BTUH) ①	Uncrated Dimensions(in.)			Shipping Weight (lbs.)	Sound PRESSURE Level ②	MCA*	Max. Fuse*	Line Size (in)	
			W	D	H					OD Gas	OD Liq.
4TVX0018B100NB	208/230/1/60	18,000	39.4	7.9	25.5	56.2	34-40	0.53	15	1/2	1/4
4TVX0024B100NB	208/230/1/60	24,000	39.4	7.9	25.5	56.2	40-44	0.60	15	5/8	3/8

**Table DU-11-E — R-410A VRF High Wall** ⑤



**4TVW00**

Indoor Model Number	Power Supply	Nom. Cap. Cooling (BTUH) ①	Uncrated Dimensions(in.)			Shipping Weight (lbs.)	Sound PRESSURE Level ②	MCA*	Max. Fuse*	Line Size (in)	
			W	D	H					OD Gas	OD Liq.
4TVW0007B100NC	208/230/1/60	7,500	32.5	7.5	11.3	24.3	27-31	0.32	15	1/2	1/4
4TVW0009B100NC	208/230/1/60	9,500	32.5	7.5	11.3	24.3	27-31	0.32	15	1/2	1/4
4TVW0012B100NC	208/230/1/60	12,000	32.5	7.5	11.3	24.3	29-37	0.38	15	1/2	1/4
4TVW0018B100NC	208/230/1/60	18,000	41.9	8.6	11.8	34.2	38-44	0.45	15	1/2	1/4
4TVW0020B100NC	208/230/1/60	20,000	41.9	8.6	11.8	34.2	38-44	0.48	15	1/2	1/4
4TVW0024B100NC	208/230/1/60	23,200	41.9	8.6	11.8	34.2	38-45	0.50	15	5/8	3/8

① Nominal capacity based on 25 ft. of equivalent refrigerant piping with 0 ft. level difference  
 - Cooling: Indoor temperature 80°F DB, 67°F WB/Outdoor temperature 95°F DB, 75°F WB  
 - Heating: Indoor temperature 70°F DB, 60°F WB/Outdoor temperature 47°F DB, 43°F WB  
 ② Sound pressure was acquired in a dead room. Actual noise level may be different depending on installation conditions.  
 ③ Optional internal condensate drain pump must be ordered separately if gravity drain is not possible.  
 ④ EEV kit is required and must be ordered as a separate item.  
 ⑤ Condensate pump, if necessary, is available through sales.  
 \* Information subject to change. Please confirm with current Product Data for current factory production.

# American Standard AccuFlex™ VRF Indoor Units

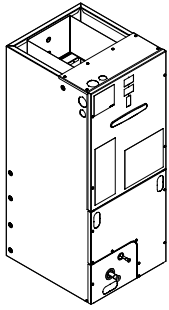

**Table DU-12-A — R-410A Convertible Ducted Air Handling Unit**

Indoor Model Number	Power Supply	Nom. Cap. Cooling (BTUH) ①	Uncrated Dimensions(in.)			Shipping Weight (lbs.)	Sound PRESSURE Level ②	MCA*	Max. Fuse*	Line Size (in)	
			W	D	H					OD Gas	OD Liq.
4TVM0024B100NB	208/230/1/60	18,000	35.4	18.8	10.3	72.8	31-35	1.75	15	1/2	1/4
4TVM0030B100NB	208/230/1/60	24,000	35.4	18.8	10.3	72.8	31-39	1.88	15	5/8	3/8
4TVM0036B100NB	208/230/1/60	30,000	45.3	18.8	12.6	89.3	34-40	1.88	15	5/8	3/8
4TVM0042B100NB	208/230/1/60	36,000	45.3	18.8	12.6	89.3	38-41	2.00	15	5/8	3/8
4TVM0048B100NB	208/230/1/60	36,000	45.3	18.8	12.6	89.3	38-41	2.00	15	5/8	3/8
4TVM0060B100NB	208/230/1/60	36,000	45.3	18.8	12.6	89.3	38-41	2.00	15	5/8	3/8

Note: Must be used with 4TVCTRLAHU0001A Controller for 4TVM

**Table DU-12-B — Controller for 4TVM**

4TVCTRLAHU0001A	208/230/1/60	All 4TVM's	15.0	5.0	11.0	11.0	Must be ordered as a separate item.
-----------------	--------------	------------	------	-----	------	------	-------------------------------------

**Table DU-12-C — Electric Heaters for 4TVM**

Model Number	Power Supply	Nominal Capacity Heating @ 240 volts				Nominal Capacity Heating @ 208 volts			
		Circuit 1 KW	Circuit 1 BTUH	Circuit 2 KW	Circuit 2 BTUH	Circuit 1 KW	Circuit 1 BTUH	Circuit 2 KW	Circuit 2 BTUH
BAYHTR1504	208-230/60/1	3.84	13100			2.88	9800		
BAYHTR1505	208-230/60/1	4.8	16400			3.6	12300		
BAYHTR1508	208-230/60/1	7.68	26200			5.76	19700		
BAYHTR1510	208-230/60/1	9.6	32800			7.2	24600		
BAYHTR1515	208-230/60/1	9.6	32800	4.8	16400	7.2	24600	3.6	12300
BAYHTR1519	208-230/60/1	9.6	32800	9.6	32800	7.2	24600	7.2	24600
BAYHTR1520	208-230/60/1	9.6	32800	9.6	32800	7.2	24600	7.2	24600
BAYHTR3510	208-230/60/1	9.6	32800			7.2	24600		
BAYHTR3515	208-230/60/1	14.4	49200			10.8	36900		

This page indicates available products, however, specific applications including 4TVM Indoor units with VRF outdoor systems shall be validated through VRF select.

Electric heater selections shall be validated by the unit nameplate, a listing of approved heaters may be obtained in product data catalog VRF-PRC025\*-EN. (\*will be A, B, C, etc. indicating the most current version).

Electrical Branch Circuits shall be validated by the unit nameplate data. This data is also listed in the product data catalog VRF-PRC025\*-EN.

Printed literature is updated periodically; however, product change and development may dictate a unit nameplate change; in all cases, the unit nameplate values rule.

Ductless

# American Standard AccuFlex™ VRF Outdoor Units

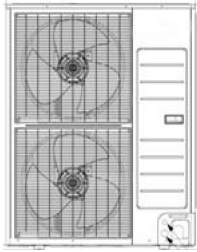

**Table DU-13-A — R-410A VRF 208~230V Heat Pump Single Modules**

Outdoor Model Number	Power Supply	Nom. Cap. Cooling (BTUH) ①③	Uncrated Dimensions(in.)			Shipping Weight (lbs.)	Sound PRESSURE Level ②			Line Size (in)	
			W	D	H		MCA*	MOP	OD Gas	OD Liq.	
4TVH0036B100NB	208/230/1/60	38,000	37	13	47.6	231.5	50	23	40	5/8	3/8
4TVH0048B100NB	208/230/1/60	48,000	37	13	47.6	231.5	51	29	50	5/8	3/8
4TVH0053B100NB	208/230/1/60	53,000	37	13	47.6	238	53	34	55	3/4	3/8

For model combinations not listed and unit details, please refer to the American Standard Product Catalog publication VRF-PRC019\*-EN (\*will be A, B, C, etc. indicating the most current version).

- ① Nominal capacity based on 25 ft. of equivalent refrigerant piping with 0 ft. level difference
  - Cooling: Indoor temperature 80°F DB, 67°F WB/Outdoor temperature 95°F DB, 75°F WB
  - Heating: Indoor temperature 70°F DB, 60°F WB/Outdoor temperature 47°F DB, 43°F WB
- ② Sound pressure was acquired in a dead room. Actual noise level may be different depending on installation conditions.
- ③ Rated per AHRI Unitary Small HP Standard 210/240

**Table DU-13-B — Optional outdoor unit accessory**

Model Number	Description
TVGARD003A	Hail Guard for 4TVH0036B100NB / 4TVH0048B100NB / 4TVH0053B100NB

# American Standard AccuFlex™ VRF Mode Control Unit (MCU)

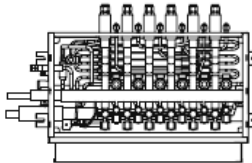

4MCUCUY6N (6 port unit)

**Table DU-13-C — R-410A VRF Mode Control Unit (MCU) ①②**

Outdoor Model Number	Power Supply	Max Capacity BTUH	Uncrated Dimensions(in.)			Shipping Weight (lbs.)	No. Of Ports	MCA	MOP
			L	W	H				
4MCUCUY2NCE000	208/230/1/60	192,000	32.6	7.9	18.5	63.9	2	0.63	15
4MCUCUY4NCE000	208/230/1/60	120,000	32.6	7.9	18.5	63.9	4	0.63	15
4MCUCUY6NCE000	208/230/1/60	180,000	32.6	7.9	18.5	70.5	6	0.63	15

- ① The MCA and MOP listed for the MCU applies to the MCU only.
- ② If the MCU is used to distribute high voltage power to the indoor units, the electrical branch circuit size and overcurrent protection device rating shall be calculated using the adopted National Electrical Code (NEPA 70E) per the Authority Having Jurisdiction (AHJ). The maximum current draw through the MCU and overcurrent protection device shall not exceed 15 AMPS.

# American Standard AccuFlex™ VRF Outdoor Units

**Table DU-14-A — R-410A VRF 208~230V Heat Pump Single Modules**

Outdoor Model Number	Power Supply	Nom. Cap. Cooling (BTUH)	Uncrated Dimensions(in.)			Shipping Weight (lbs.)	Sound PRESSURE			Line Size (in)	
			W	D	H		Level <sup>①</sup>	MCA <sup>②</sup>	MOP <sup>②</sup>	OD Gas	OD Liq.
4TVH0072B300NB	208/230/3/60	72,000	34.6	30.1	66.7	461	60	28.0	35	3/4	3/8
4TVH0096B300NB	208/230/3/60	96,000	50.9	30.1	66.7	666	61	37.8	50	7/8	3/8
4TVH0120B300NB	208/230/3/60	120,000	50.9	30.1	66.7	666	61	43.0	50	1 1/8	1/2
4TVH0144B300NB	208/230/3/60	144,000	50.9	30.1	66.7	699	62	52.6	70	1 1/8	1/2
4TVH0168B300NC	208/230/3/60	168,000	50.9	30.1	66.7	754	63	66.0	100	1 1/8	5/8
4TVH0192B300NC	208/230/3/60	192,000	50.9	30.1	66.7	772	64	80.3	100	1 1/8	5/8

**Table DU-14-B — R-410A VRF 208~230V Heat Recovery Single Modules**

Outdoor Model Number	Power Supply	Nom. Cap. Cooling (BTUH)	Uncrated Dimensions(in.)			Shipping Weight (lbs.)	Sound PRESSURE			Line Size (in)		
			W	D	H		Level <sup>①</sup>	MCA <sup>②</sup>	MOP <sup>②</sup>	OD Gas	OD Liq.	HOT Gas
4TVR0072B300NB	208/230/3/60	72,000	34.6	30.1	66.7	465	60	28.0	35	3/4	3/8	5/8
4TVR0096B300NB	208/230/3/60	96,000	50.9	30.1	66.7	679	61	37.8	50	7/8	3/8	3/4
4TVR0120B300NB	208/230/3/60	120,000	50.9	30.1	66.7	679	61	43.0	50	1 1/8	1/2	7/8
4TVR0144B300NB	208/230/3/60	144,000	50.9	30.1	66.7	714	62	52.6	70	1 1/8	1/2	7/8
4TVR0168B300NC	208/230/3/60	168,000	50.9	30.1	66.7	770	63	66.0	100	1 1/8	5/8	7/8
4TVR0192B300NC	208/230/3/60	192,000	50.9	30.1	66.7	778	64	80.3	100	1 1/8	1/2	1 1/8

**Table DU-14-C — R-410A VRF 460V Heat Pump Single Modules**

Outdoor Model Number	Power Supply	Nom. Cap. Cooling (BTUH)	Uncrated Dimensions(in.)			Shipping Weight (lbs.)	Sound PRESSURE			Line Size (in)	
			W	D	H		Level <sup>①</sup>	MCA <sup>②</sup>	MOP <sup>②</sup>	OD Gas	OD Liq.
4TVH0072B400NB	460/3/60	72,000	34.6	30.1	66.7	472	60	16.4	20	3/4	3/8
4TVH0096B400NB	460/3/60	96,000	50.9	30.1	66.7	582	61	19.0	25	7/8	3/8
4TVH0120B400NB	460/3/60	120,000	50.9	30.1	66.7	582	61	21.7	30	1 1/8	1/2
4TVH0144B400NB	460/3/60	144,000	50.9	30.1	66.7	714	62	26.4	40	1 1/8	1/2
4TVH0168B400NC	460/3/60	168,000	50.9	30.1	66.7	757	63	31.3	40	1 1/8	5/8
4TVH0192B400NC	460/3/60	192,000	50.9	30.1	66.7	774	64	37.5	50	1 1/8	5/8

**Table DU-14-D — R-410A VRF 460V Heat Recovery Single Modules**

Outdoor Model Number	Power Supply	Nom. Cap. Cooling (BTUH)	Uncrated Dimensions(in.)			Shipping Weight (lbs.)	Sound PRESSURE			Line Size (in)		
			W	D	H		Level <sup>①</sup>	MCA <sup>②</sup>	MOP <sup>②</sup>	OD Gas	OD Liq.	HOT Gas
4TVR0072B400NB	460/3/60	72,000	34.6	30.1	66.7	481	60	16.4	20	3/4	3/8	5/8
4TVR0096B400NB	460/3/60	96,000	50.9	30.1	66.7	595	61	19.0	25	7/8	3/8	3/4
4TVR0120B400NB	460/3/60	120,000	50.9	30.1	66.7	595	61	21.7	30	1 1/8	1/2	7/8
4TVR0144B400NB	460/3/60	144,000	50.9	30.1	66.7	734	62	26.4	40	1 1/8	1/2	7/8
4TVR0168B400NC	460/3/60	168,000	50.9	30.1	66.7	770	63	31.3	40	1 1/8	1/2	7/8
4TVR0192B400NC	460/3/60	192,000	50.9	30.1	66.7	788	64	37.5	50	1 1/8	1/2	1 1/8

For model combinations not listed and unit details, please refer to the American Standard Product Catalog publication VRF-PRC019\*-EN (\*will be A, B, C, etc. indicating the most current version).

- ① Sound pressure was acquired in a dead room. Actual noise level may be different depending on installation conditions.
- ② Information subject to change. Please confirm with current Product Data for current factory production.

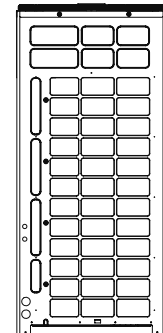
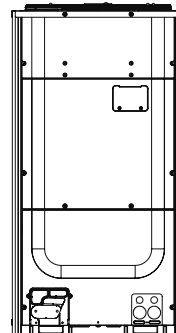
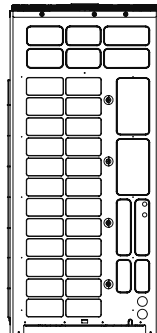

Ductless

For complete equipment / combination selections, installation instructions and warranty information, please refer to Product Data/Ratings and/or Installers Guides and Limited Warranty Handbooks.

## Controls

Family	Description	Model Number
Integrated System Management	VRF System Controller	TVCTRLTIMD00A0
	VRF Enterprise Management Software	TVCTRLTSTP3P00
Building Management System Gateways	VRF System Controller +BACnet	TVCTRLTIMB17A0
	VRF System Controller +LONTalk	TVCTRLTIMB18A0
Centralized Control Systems	VRF Central On/Off Controller	TVCTRLTCMA202D
	VRF System TouchScreen Control	TVCTRLTCMA300A
	VRF Mode Select Switch	TVCTRLTCMC2000
Zone Controllers	VRF Wireless Remote Control	TVCTRLTRDH00UA
	VRF Wired Control	TVCTRLTWRWD01A
	VRF Simple Wired Control	TVCTRLTWR001A
	VRF Simple Wired Touch Control	TVCTRLTWR0002A
	VRF Duct Signal Receiver & Wire	TVCTRLTRKA10N0
Interface Modules	VRF External Contact Interface Module	TVCTRLTIMB14A0
Sensors	VRF Ext. Room Temp Sensor	TVCTRLTRWTA000
Utility Kits	VRF Motion Sensor Mini 4Way	MOTIONSEN4TVB
	VRF Technician Utilities	TVCTRLTIMC0300

## EEV Kits

Table for use with 4TVW\*\*\*B100NB and TVX models. Please note that 4TVW\*\*\*B100NC models ship with internal EEV factory installed.

Indoor unit type and combinations

	EEV KIT	4TVW0007B100NB 4TVW0009B100NB 4TVW0012B100NB		4TVW0018B100NB 4TVW0020B100NB 4TVW0024B100NB  4TVX0018B100NB 4TVX0024B100NB
Single room application	4EEVEVA24SA000	Any 1		N/A
	4EEVEVA32SA000	N/A		Any 1
Double room application	4EEVXDA24K132A	Any 1	Plus	Any 1
	4EEVXDA24K200A	Any 2		N/A
	4EEVXDA32K200A	N/A		Any 2
Triple room application	4EEVXDA24K232A	Any 2	Plus	Any 1
	4EEVXDA24K300A	Any 3		N/A
	4EEVXDA32K224A	Any 1	Plus	Any 2
	4EEVXDA32K300A	N/A		Any 3

Note: Cassette and concealed (fan coil) type indoor units come with a factory installed EEV and cannot be installed with the above EEV kits.

## Accessories

Family	Description	Model Number
Indoor Y-Joint	VRF Y-Joint <51MBh	4YDK1509B0051A
	VRF Y-Joint 51-138MBh	4YDK2512B0138A
	VRF Y-Joint 138-160MBh	4YDK2812B0160A
	VRF Y-Joint 160-240MBh	4YDK2815B0240A
	VRF Y-Joint 240-336MBh	4YDK3419B0336A
	VRF Y-Joint 336-468MBh	4YDK4119B0468A
	VRF Y-Joint >468MBh	4YDK4422B0999A
Indoor Y-Joint (High Pressure Gas for HR)	VRF Y-Joint HR ≤80MBh	4YDK1500B0080A
	VRF Y-Joint HR 80-240MBh	4YDK2500B0240A
	VRF Y-Joint HR 240-468MBh	4YDK3100B0468A
	VRF Y-Joint HR >468MBh	4YDK3800B0999A
Outdoor Y-Joint (Outdoor Connection)	Outdoor VRF Y-Joint ≤468MBh	4TDK3819B0000A
	Outdoor VRF T-Joint HR ≤468MBh	4TDK3100B0000A
Header Joint	VRF Header Joint 4Units <160MBh	4HJK2512B0159A
	VRF Header Joint 8Units ≤240MBh	4HJK3115B0241A
	VRF Header Joint 8Units >240MBh	4HJK3819B0998A
MCU-Kit	VRF MCU Kit up to 6 IDU	4MCUCUY6NCE000
	VRF MCU Kit up to 4 IDU	4MCUCUY4NCE000
	VRF MCU Kit 2 IDU HSP Only	4MCUCUY2NCE000
EEV Kits (For Wall-mounted & Ceiling indoor unit)	VRF EEV 1x 7-15.5& 1x 17-31MBh	4EEVXDA24K132A
	VRF EEV Kit 2Unit 7-15.5MBh	4EEVXDA24K200A
	VRF EEV Kit 2Unit 17-31MBh	4EEVXDA32K200A
	VRF EEV 2x 7-15.5& 1x 17-31MBh	4EEVXDA24K232A
	VRF EEV Kit 3Unit 7-15.5MBh	4EEVXDA24K300A
	VRF EEV 1x 7-15.5& 2x 17-31MBh	4EEVXDA32K224A
	VRF EEV Kit 3Unit 17-31MBh	4EEVXDA32K300A
	VRF EEV Kit 1Unit 7-15.5MBh	4EEVEVA24SA000
	VRF EEV Kit 1Unit 17-31MBh	4EEVEVA32SA000
AHU Kit	VRF AHU Kit 24-30MBh	4EEVAKA40K1025
	VRF AHU Kit 48-60MBh	4EEVAKA40K1050
	VRF AHU Kit 72-90MBh	4EEVAKA64K1075
	VRF AHU Kit 96-112MBh	4EEVAKA64K1100
Drain Pump	VRF Drain Pump Slim Duct	CONDPUMPXVLB01
	VRF Drain Pump MSP 18/24MBh	CONDPUMPXVMB01
	VRF Drain Pump MSP 30/36MBh	CONDPUMPXVMB02
	VRF Drain Pump MSP48/ HSP36-48MBh	CONDPUMPXVDB01
	VRF Drain Pump HSP 76.8/96MBh	CONDPUMPXVHB01
Cassette Panel	VRF Cassette Panel Slim 1Way	TVEPANPC1NUSSET
	VRF Cassette Panel Sliding 1Way	TVEPANPC1NUAET
	VRF Cassette Panel Mini 4Way	TVEPANPC4SUSSET
	VRF Cassette Panel 4Way	TVEPANPC4NUSSET
Hail Guards	4TVH/4TVR0072B	TVGARD001A
	4TVH/4TVR0096B-192B	TVGARD002A
	4TVH0036B, 4TVH0048B, 4TVH0053B	TVGARD003A

Ductless

## Roof Curbs

### BAYCURB050A FULL PERIMETER ROOF MOUNTING CURB OUTLINE

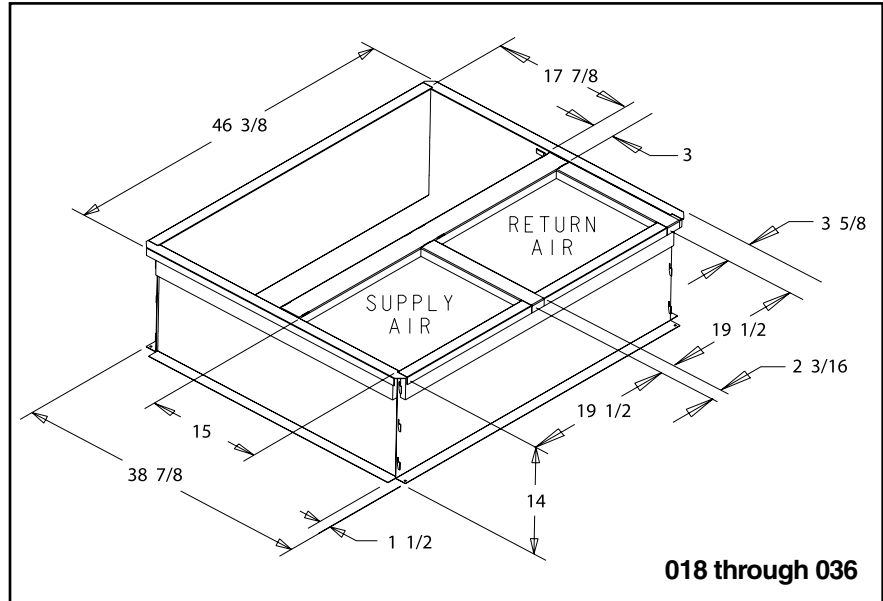

Full Perimeter BAYCURB050A	Full Perimeter BAYCURB051A
4TCY4024-036	4TCY4042-060
4TCX3018-036/4TCC3018-036	4TCX3042-060/4TCC3042-060
4WCZ6036/4DCZ6036	4WCZ6048-060/4DCZ6048-060
4WCY4024-036/4DCY4024-036	4WCY4042-060/4DCY4042-060
2/4WCX3018-036/2/4WCC3018-036	2/4WCX3042-060/2/4WCC3042-060
4YCZ6036	4YCZ6048-060
4YCY4024-036	4YCY4042-060
2/4YCX3018-036/2/4YCC3018-036	2/4YCX3042-060/2/4YCC3042-060

### BAYCURB051A FULL PERIMETER ROOF MOUNTING CURB OUTLINE

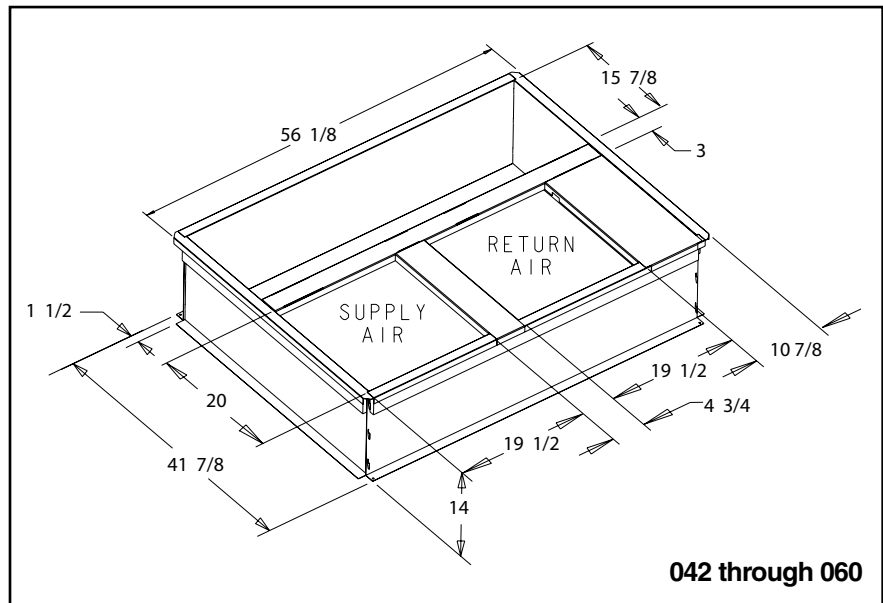



# Thermal Expansion Valves

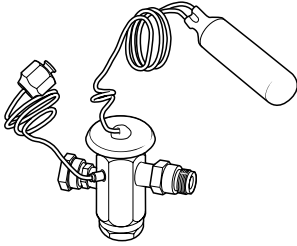

**Expansion Valve TXV  
Cooling/Heat Pump Kit**

**General Information**

This Thermostatic Expansion Valve Kit may be used on any indoor air handler or coil that is equipped with a current thermostatic expansion valve with an internal check valve and mechanical fittings. This kit can be used on split system heat pumps and air conditioning systems.

Thermostatic Expansion Valve Kits can be field installed to fit a variety of sizes and combinations of air handlers or coils and outdoor units to optimize performance.

This TXV kit will normally be used when a different refrigerant is going to be used in the air handler or coil than what is indicated on the unit name plate. The TXV type must always match the refrigerant type used in the outdoor unit.

**Kit Identification**

The first character in the kit model number indicates the type of refrigerant that the valve can be used with. Example a 2AYTXVH3D1830A is an R-22 valve.

The "3" in the eighth digit in the model number identifies the valve as a non-bleed TXV. When this TXV kit is installed with an outdoor unit that contains a reciprocating compressor, the outdoor unit must be equipped with a hard start kit if not factory installed. If the outdoor unit contains a scroll compressor, the installation of a hard start kit may be required.

**Inspection**

Check carefully for any shipping damage. Any such damage must be reported and claims made against the transportation company immediately. Any missing parts should be reported to your supplier at once and replaced with authorized parts only.

**Table AC/IN-2-A Cooling/Heat Pump Non-Bleed TXV Kits- Dual Direction Flow-TXA/C-BC Coils**

R-410 Model Number	R-22 Model Numbers	Used With 13 SEER Coils
4AYTXVH3D1831A	2AYTXVH3C1818A	2/4TXC, TXA018
4AYTXVH3D1831A	2AYTXVH3C2425A	2/4TXC, TXA024,025
4AYTXVH3D1831A	2AYTXVH3C3031A	2/4TXC, TXA031
4AYTXVH3D3343A	—4TXC, 4TXA-032	
4AYTXVH3D3343A	2AYTXVH3C3337A	2/4TXC, TXA036,037
4AYTXVH3D3343A	2AYTXVH3C4243A	2/4TXC, TXA042,043
4AYTXVH3D4863A	—4TXC, 4TXA-044	
4AYTXVH3D4863A	2AYTXVH3C4850A	2/4TXC, TXA048,049,050
4AYTXVH3D4863A	2AYTXVH3C5463A	2/4TXC, TXA060,061,064

**Table AC/IN-2-B Cooling/Heat Pump Non-Bleed TXV Kits- Dual Direction Flow**

R-410 Model Number	R-22 Model Number	Used With Horizontal Flat Coils
4AYTXVH3D1831A	2AYTXVH3C1818A	2/4TXF-018
4AYTXVH3D3343A	2AYTXVH3C3337A	2/4TXF-033
4AYTXVH3D3343A	2AYTXVH3C4243A	2/4TXF-041
4AYTXVH3D4863A	2AYTXVH3C5463A	2/4TXF-054
4AYTXVH3D4863A	2AYTXVH3C5463A	2/4TXF-063

**Table AC/IN-2-C Cooling/Heat Pump Non-Bleed TXV Kits- Dual Direction Flow-TXA/C-AS Coils**

R-410 Model Number	R-22 Model Number	Used With AS Aluminum Coils
4AYTXVH3B2531A	2AYTXVH3B2531A	2/4TXA, TXC-025
4AYTXVH3B2531A	2AYTXVH3B2531A	2/4TXA, TXC-031
4AYTXVH3B3654A	2AYTXVH3B3637A	2/4TXA, TXC-036
4AYTXVH3B3654A	2AYTXVH3B3637A	2/4TXA, TXC-037
4AYTXVH3B3654A	2AYTXVH3B5454A	2/4TXA, TXC-054
4AYTXVH3B6165A	2AYTXVH3B6565A	2/4TXA, TXC-065

**Table AC/IN-2-D Cooling/Heat Pump Non-Bleed TXV Kits – Dual Direction Flow 4NXA/4NXC**

R-22 Number	Used With 4NXA & 4NXC Coils
2AYTXVH3E1824AA	4NXA, NXC – 018 - 024
2AYTXVH3E2536AA	4NXA, NXC – 025 - 036
2AYTXVH3E6363AA	4NXC - 063

**Table AC/IN-2-E Cooling/Heat Pump Non-Bleed TXV Kits- Dual Direction Flow**

R-410 Number	R-22 Numbers	Used With Air Handlers
4AYTXVH3D1830A	2AYTXVH3D1830A	2TFB-018-030
4AYTXVH3D1831A	2AYTXVH3D1830A	2TFB-036
4AYTXVH3D1831A	2AYTXVH3D1830A	2/4TFE-025
4AYTXVH3D1831A	2AYTXVH3D1830A	2/4TEC-018-030
—	2AYTXVH3D3636A	2/4TEC-036
4AYTXVH3D3642A	—	2/4TEC-036-042
—	2AYTXVH3D4260A	2/4TEC-042-060
4AYTXVH3D4863A	—	2/4TEC-048-060
4AYTXVH3D1831A	2AYTXVH3D1830A	2/4TEH-018-030
—	2AYTXVH3D3636A	4TEH-036
4AYTXVH3D3642A	—	2TEH-036-042
—	2AYTXVH3D4260A	4TEH-042-060
4AYTXVH3D4863A	—	2TEH-048-060
4AYTXVH3D1800A	2AYTXVH3D1830A	2/4TGB-018
4AYTXVH3D1830A	2AYTXVH3D1830A	2/4TGB-025
4AYTXVH3D1831A	2AYTXVH3D1830A	2/4TGB-030
4AYTXVH3D3600A	2AYTXVH3D1830A	2/4TGB-036
4AYTXVH3D3343A	2AYTXVH3D4260A	2/4TGB-042
4AYTXVH3D4863A	2AYTXVH3D4260A	2/4TGB-048
4AYTXVH3D3642A	2AYTXVH3D4260A	2/4TEE-039
4AYTXVH3D4863A	2AYTXVH3D4260A	2/4TEE-048-064

For complete equipment / combination selections, installation instructions and warranty information, please refer to Product Data/Ratings and/or Installers Guides and Limited Warranty Handbooks.

# Thermal Expansion Valves

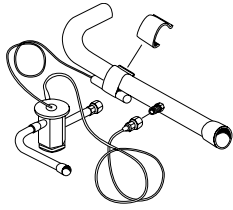

**Expansion Valve TXV Cooling Kit**

**Table AC/IN-3-A — Cooling Bleed TXV Kits – Single Direction Flow**

Model Number	Used With AC Units	Liquid Line Connection Dia. I.D. (In.)	Gas Line Connection Dia. I.D. (In.)	Shipping Weight (lbs.)	Refrigerant
TAYTXVA0B5C	1-1½ Ton	¼	⅝	2	R-22
TAYTXVA0C5C	2-2½ Ton	⅝ <sub>16</sub>	¾	2	R-22
TAYTXVA0E5C	3-3½ Ton	⅜	⅞	2	R-22
TAYTXVA0G5C	4 Ton	⅜	1⅛	2	R-22
TAYTXVA0H5C	5-6 Ton	⅜	1⅛	2	R-22

**Table AC/IN-3-B — Cooling Non-Bleed TXV Kits – Single Direction Flow**

Model Number	Used With AC Units	Liquid Line Connection Dia. I.D. (In.)	Gas Line Connection Dia. I.D. (In.)	Shipping Weight (lbs.)	Refrigerant
TAYTXVA0B3C	1-1½ Ton	¼	⅝	2	R-22
TAYTXVA0C3C	2-2½ Ton	⅝ <sub>16</sub>	¾	2	R-22
TAYTXVA0E3C	3-3½ Ton	⅜	⅞	2	R-22
TAYTXVA0G3C	4 Ton	⅜	1⅛	2	R-22
TAYTXVA0H3C	5-6 Ton	⅜	1⅛	2	R-22

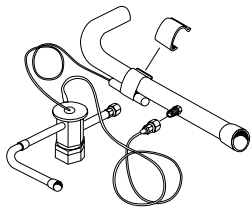

**Expansion Valve TXV Heat Pump Kit\***

**Table AC/IN-3-C — Heat Pump Non- Bleed TXV Kits (also for cooling) – Dual Direction Flow**

Model Number	Used With AC Units	Liquid Line Connection Dia. I.D. (In.)	Gas Line Connection Dia. I.D. (In.)	Shipping Weight (lbs.)	Refrigerant
TAYTXVH0B3C	1-1½ Ton	¼	⅝	3	R-22
TAYTXVH0C3C	2-2½ Ton	⅝ <sub>16</sub>	¾	3	R-22
TAYTXVH0E3C	3-3½ Ton	⅜	⅞	3	R-22
TAYTXVH0G3C	4 Ton	⅜	1⅛	3	R-22
TAYTXVH0H3C	5-6 Ton	⅜	1⅛	3	R-22

**Table AC/IN-3-D— Cooling/Heat Pump Non-Bleed TXV Kits - Dual Direction Flow\***

Model Number	Used With AC Units	Liquid Line Connection Dia. I.D. (In.)	Gas Line Connection Dia. I.D. (In.)	Shipping Weight (lbs.)	Refrigerant
TAYTXVH0D3C	2½ -3 Ton	⅜	1⅛	2	R-22
TAYTXVH0G3C	4-5 Ton	⅜	1⅛	2	R-22

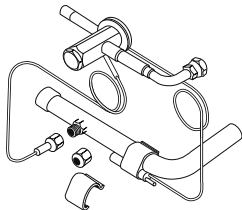

**Table AC/IN-3-E— R-410A Heat Pump Non-Bleed TXV Kits (also for cooling) - Dual direction flow**

Model Number	Used With HP/AC Units	Liquid Line Connection Dia. I.D. (In.)	Gas Line Connection Dia. I.D. (In.)	Shipping Weight (lbs.)	Refrigerant
4AYTXVH3A1830A	1½-2½ Ton	⅝ <sub>16</sub> ①	¾②	2	R-410A
4AYTXVH3A3654A	3-4 Ton	⅜	⅞③	2	R-410A
4AYTXVH3A6060A	5 Ton	⅜	⅞	2	R-410A

- ① 1 1/2 ton requires 1/4" liquid line; reducer fittings provided.
- ② 1 1/2 ton requires 1/2" suction line, 2 ton requires 5/8; reducer fittings provided.
- ③ 3 & 3 1/2 ton requires 3/4" suction line; reducer fitting provided.

\* Used with TXH coils only where approved for use with 2 compressor systems.

**Notes:**

- Use in place of FCCV (Above) on air handlers and coils
- Match TXV kit size to outdoor nominal cooling capacity
- Braze field connections

# Equipment Date Identification

## 1980 – 2009

The nine digit serial numbers on all American Standard central air conditioning and heating products are employed to identify the year and fiscal week of product manufacture.

Year of manufacture ..... First digit..... **M124X04CF**  
 Fiscal week of manufacture..... Second and third digit ..... **M124X04CF**  
 Day of week of manufacture..... Fourth digit ..... **M124X04CF**  
 Consecutive order of production ..... Last Five digits ..... **M124X04CF**

**Exception** – Accessories are an exception to the nine digit serial number assignment and may have only three digits to indicate date code. Coils which have only three digits to indicate date code are an exception to the nine digit serial number assignment.

Year	Residential, ID & OD <sup>①</sup> Light Commercial Products & Compressors	Ducane Oil <sup>①</sup> Horizontal Gas Furnaces <sup>②</sup>	Year	Residential, ID & OD <sup>①</sup> Light Commercial Products & Compressors	Ducane Oil <sup>①</sup> Horizontal Gas Furnaces <sup>②</sup>	Year	Residential, ID & OD <sup>①</sup> Light Commercial Products & Compressors	Ducane Oil <sup>①</sup> Horizontal Gas Furnaces <sup>②</sup>
1980	O, A	L	1997	M	97	2014	14	—
1981	T	M	1998	N	98	2015	15	—
1982	U	N	1999	P	99	2016	16	—
1983	W	9	2000	R	—	2017	17	—
1984	X	Q	2001	Z	—	2018	18	—
1985	Y	85	2002	2	—	2019	19	—
1986	S	86	2003	3	—			
1987	B	87	2004	4	—			
1988	C	88	2005	5	—			
1989	D	89	2006	6	—			
1990	E	90	2007	7	—			
1991	F	91	2008	8	—			
1992	G	92	2009	9 or 09	—			
1993	H	93	2010	10	—			
1994	J	94	2011	11	—			
1995	K	95	2012	12	—			
1996	K	96	2013	13	—			

① **Beginning with 1/1/96 (L01) Ducane oil furnace production uses same date code method as gas furnace. Prior to 1/1/96 Ducane serial number used last four digits = date code, example HA1234569540 1995, 40th week.**

Example: 123456-**8 5 4 0**

Year of manufacture \_\_\_\_\_ Fiscal week of manufacture \_\_\_\_\_

② **Dedicated horizontal gas furnaces, production ceased after introduction of convertible furnaces. 2010**

Digit	Description	Current Digit Value Options
1 <sup>ST</sup>	Second to Last integer of the current calendar year	1 through 9 and blank space, Blank Space used when 0 (zero)
2 <sup>ND</sup>	Last integer of the current calendar year	0 through 9
3 <sup>RD</sup>	Fiscal Week (Tens numeral)	0 through 5
4 <sup>TH</sup>	Fiscal Week (Units numeral)	0 through 9
5 <sup>TH</sup>	Day of the Week	1 through 7
6 <sup>TH</sup>	Time Stamp	A through Z and 0 through 9, excluding I, O, Q, V, Y, and Z
7 <sup>TH</sup>	Time Stamp	A through Z and 0 through 9, excluding I, O, Q, V, Y, and Z
8 <sup>TH</sup>	Time Stamp	A through Z and 0 through 9, excluding I, O, Q, V, Y, and Z
9 <sup>TH</sup>	Assembly Line Designator	A through Z and 0 through 9, excluding I, O, Q, V, Y, and Z
10 <sup>TH</sup>	Plant Code	A, D, F, G, H, V, Y, X

Plant Codes: (starting around 1995)
A = Monterrey
D = Springhill, LA (used to be the last character of a 10 digit serial on Ft. Smith products when they were sold commercially back in the late 1980's)
F = Tyler, TX
G = Trenton, NJ
H = Ft. Smith, AR
L = Lynn Haven, FL
V = Vidalia, GA
X = Sourced products

Accessories/Information

For complete equipment / combination selections, installation instructions and warranty information, please refer to Product Data/Ratings and/or Installers Guides and Limited Warranty Handbooks.

## Refrigerant Line Sets

**Table AC/IN-5-A — Refrigerant Line Sets**

Model Number	Gas Line <sup>①②</sup> Dia. O.D.	Liquid Line Dia. O.D.	Length	Shipping Weight
TAYREFLN325	7/8	3/8	25	20
TAYREFLN330	7/8	3/8	30	24
TAYREFLN340	7/8	3/8	40	30
TAYREFLN350	7/8	3/8	50	39
TAYREFLN725	3/4	3/8	25	19
TAYREFLN730	3/4	3/8	30	22
TAYREFLN740	3/4	3/8	40	28
TAYREFLN750	3/4	3/8	50	35
TAYREFLN950	5/8	3/8	50	30

① Gas line 90° bend one end.

② Gas line insulation 1/2" thickness.

**Note:** Contains a holding charge of Nitrogen.

# Refrigerant HFC 410A (R-410A)

Tables contain no allowances for vertical lift!

**Table AC/IN-6-A — Liquid Line Selection Table for R-410A Single Speed Systems**

Maximum Allowable Liquid Line Pressure Drop ..... =

Subtract .43 PSI for each foot of Liquid Lift (if any).....

Do Not Exceed this value when selecting Liquid Line. ....

Tube O.D.	Rated BTUH	Pressure Drop (PSI) For Total Equivalent Length											
		20'	40'	60'	80'	100'	120'	140'	160'	180'	200'	220'	240'
1/4"	15000	4.5	9.0	13.6	18.1	22.6	27.1	31.6	36.2	40.7	45.2	49.7	—
	18000	6.3	12.6	18.8	25.1	31.4	37.7	44.0	—	—	—	—	—
	24000	15.4	30.8	46.2	—	—	—	—	—	—	—	—	—
5/16"	15000	1.2	2.4	3.5	4.7	5.9	7.1	8.3	9.4	10.6	11.8	13.0	14.2
	18000	1.6	3.3	4.9	6.6	8.2	9.8	11.5	13.1	14.8	16.4	18.0	19.7
	24000	2.8	5.5	8.3	11.0	13.8	16.6	19.3	22.1	24.8	27.6	30.4	33.1
	30000	4.1	8.3	12.4	16.6	20.7	24.8	29.0	33.1	37.3	41.4	45.5	49.7
	36000	5.8	11.6	17.3	23.1	28.9	34.7	40.5	46.2	—	—	—	—
3/8"	24000	1.0	1.9	2.9	3.8	4.8	5.8	6.7	7.7	8.6	9.6	10.6	11.5
	30000	1.4	2.9	4.3	5.8	7.2	8.6	10.1	11.5	13.0	14.4	15.8	17.3
	36000	2.0	4.0	6.1	8.1	10.1	12.1	14.1	16.2	18.2	20.2	22.2	24.2
	42000	2.7	5.3	8.0	10.6	13.3	16.0	18.6	21.3	23.9	26.6	29.3	31.9
	48000	3.4	6.8	10.2	13.6	17.0	20.4	23.8	27.2	30.6	34.0	37.4	40.8
1/2"	42000	.5	1.1	1.6	2.2	2.7	3.2	3.8	4.3	4.9	5.4	5.9	6.5
	48000	.7	1.4	2.0	2.7	3.4	4.1	4.8	5.4	6.1	6.8	7.5	8.2
	60000	1.0	2.1	3.1	4.2	5.2	6.2	7.3	8.3	9.4	10.4	11.4	12.5

- Note 1: A blank space indicates a pressure drop of over 50 PSI.
- Note 2: Other existing sources of pressure drop, (solenoid valves, etc.) must be considered.
- Note 3: A vertical run with a heat pump system always results in a liquid lift (heating or cooling).
- Note 4: The smallest liquid line diameter that results in a total liquid line pressure drop of 50 PSI or less results in the most reliable system (fewer pounds of R-410A).
- Note 5: It is recommended to place units where 1/2" liquid line is not required due to the increased refrigerant volume imposed by the larger liquid line.
- Note 6: At the time this manual was printed all outdoor units were rated with 3/8" liquid line.

**Table AC/IN-6-B — Allowable Vapor Line Diameters and BTUH Loss (R-410A Single Speed Systems)**

Nominal Tons	Tube O.D. (Inches)	Press. Drop PSI/100 Ft.	BTUH Loss For Equivalent Length										
			40'	60'	80'	100'	120'	140'	160'	180'	200'	220'	240'
1.0	1/2	5.0	70	160	250	340	430	520	610	700	790	880	970
	5/8	1.5	20	50	73	100	130	155	180	210	235	265	290
1.5	1/2	10.8	173	410	640	875	1110	1340	1575	1810	2040	2275	2510
	5/8	3.1	50	120	185	250	320	385	450	520	585	655	720
	3/4	1.2	20	45	70	95	125	150	175	200	225	255	280
2.0	5/8	5.4	115	270	430	585	740	895	1050	1205	1360	1515	1670
	3/4	2.0	45	100	160	215	275	330	390	445	505	560	620
2.5	5/8	8.2	220	515	810	1110	1400	1695	1990	2290	2585	2880	3175
	3/4	3.0	80	190	295	405	515	620	730	840	945	1055	1160
	7/8	1.3	35	80	130	175	220	270	315	365	410	455	505
3.0	5/8	11.7	380	885	1390	1895	2400	2905	3410	3915	4425	4930	—
	3/4	4.3	140	325	510	700	880	1070	1255	1440	1625	1810	2000
	7/8	1.9	60	145	225	310	390	470	555	635	720	800	880
3.5	3/4	5.8	220	510	805	1095	1390	1680	1975	2265	2560	2850	3140
	7/8	2.5	95	220	345	475	600	725	850	975	1105	1230	1355
4.0	3/4	7.4	320	745	1170	1600	2025	2450	2875	3305	3730	4155	4580
	7/8	3.2	140	325	510	690	875	1060	1245	1430	1615	1795	1980
	1-1/8 <sup>③</sup>	.9	40	90	145	195	245	300	350	400	455	505	555
5.0	3/4	11.5	620	1450	2280	3105	3935	4760	5590	6415	7245	8073	8900
	7/8	4.9	265	615	970	1325	1675	2030	2380	2735	3080	3440	3795
	1-1/8	1.3	70	165	255	350	445	540	630	725	820	915	1005

- Note 1: Shaded value indicates more than 10% capacity loss.
- Note 2: Blank space indicates more than 15% capacity loss.
- Note 3: Only approved for cooling units, do not use 1 1/8" vapor lines on heat pumps less than 5 ton.
- Note 4: If linear length exceeds 150 feet, add 2 ounces of approved compressor oil per every 10 feet in excess of 150 feet. (Example: if the actual line length is 170 feet, add 4 ounces of oil to the system)

Accessories/Information

**This page contains limited data to fully determine if the application will work or to select required accessories. Please refer to publication 14-4050-01 for complete details and examples.**

For complete equipment / combination selections, installation instructions and warranty information, please refer to Product Data/Ratings and/or Installers Guides and Limited Warranty Handbooks.

# Refrigerant Piping Information for Two Stage Split Systems

**Table AC/IN-7-A — Allowable Vapor and Liquid Line Diameters for Multistage Split Systems**

OD Unit nominal capacity	Rated Vapor Line OD	Vapor Service Valve OD	Minimum Alternative Vapor Line OD	Maximum Alternative Vapor Line OD	Rated Liquid Line OD	Liquid Service Valve OD	Minimum Alternative Liquid Line OD	Maximum Alternative Liquid Line OD
<b>Platinum XM</b>								
2 ton CLG	5/8"	5/8"	5/8"	3/4"	5/16"	5/16"	5/16"	3/8"
3 ton CLG	3/4"	3/4"	5/8"	7/8"	3/8"	3/8"	5/16"	3/8"
4 ton CLG	7/8"	7/8"	3/4"	7/8"	3/8"	3/8"	3/8"	3/8"
5 ton CLG	7/8" or 1 1/8"	7/8"	3/4"	1 1/8"	3/8"	3/8"	3/8"	3/8"
2 ton HP	5/8"	5/8"	5/8"	3/4"	5/16"	5/16"	5/16"	3/8"
3 ton HP	3/4"	3/4"	5/8"	7/8"	3/8"	3/8"	5/16"	3/8"
4 ton HP	7/8"	7/8"	3/4"	7/8"	3/8"	3/8"	3/8"	3/8"
5 ton HP	7/8" or 1 1/8"	7/8"	3/4"	1 1/8"	3/8"	3/8"	3/8"	3/8"
<b>Platinum ZM</b>								
2 ton CLG	3/4"	5/8"	5/8"	3/4"	3/8"	3/8"	5/16"	3/8"
3 ton CLG	3/4"	3/4"	5/8"	7/8"	3/8"	3/8"	5/16"	3/8"
4 ton CLG	7/8"	3/4"	3/4"	7/8"	3/8"	3/8"	3/8"	3/8"
5 ton CLG	7/8"	3/4"	3/4"	7/8"	3/8"	3/8"	3/8"	3/8"
2 ton HP	5/8"	5/8"	5/8"	3/4" - 50 feet max length	3/8"	3/8"	5/16"	3/8"
3 ton HP	3/4"	3/4"	5/8"	3/4"	3/8"	3/8"	5/16"	3/8"
4 ton HP	3/4"	3/4"	3/4"	3/4"	3/8"	3/8"	3/8"	3/8"
5 ton HP	3/4"	3/4"	3/4"	7/8" - 50 feet max length	3/8"	3/8"	3/8"	3/8"

Two compressor models share the same refrigeration circuit, however, do not operate simultaneously. Therefore, it is crucial that refrigerant lines be properly sized and do not exceed the length set forth in this guide. Please note it is recommended to use the service valve connection size tubing.

**A. Limitations:**

1. Line length limits as shipped:
  - A. Vapor line = 80 feet linear length / of the linear length, 25 feet may be installed vertical.
  - B. Liquid line = 80 feet linear length / of the linear length, 25 feet may be installed vertical.

**B. Explanation:**

1. Refrigerant lines shall not exceed 80 feet total line length. / 25 feet of the 80 feet may be vertical.
  - A. Liquid sub-cooling may not be achieved on second stage if the liquid line exceeds 80 feet.
  - B. Oil return may be sacrificed during first stage operation if the vapor line exceeds 80 feet.

**Table AC/IN-7-B — Equivalent Length (Ft.) of Non-Ferrous Valves and Fittings (Brazed)**

O.D. Tube Size (Inches)	Globe Valve	Angle Valve	Short Radius Ell	Long Radius Ell	Tee Line Flow	Tee Branch Flow
1/2"	70	24	4.7	3.2	1.7	6.6
5/8	72	25	5.7	3.9	2.3	8.2
3/4	75	25	6.5	4.5	2.9	9.7
7/8	78	28	7.8	5.3	3.7	12.0
1-1/8	87	29	2.7	1.9	2.5	8.0
1-3/8	102	33	3.2	2.2	2.7	10.0
1-5/8	115	34	3.8	2.6	3.0	12.0

Information for this chart extracted by permission from A.R.I. Refrigerant Piping Data, page 28.  
\* For smaller sizes, use 1/2" values.

**This page contains limited data to fully determine if the application will work or to select required accessories. Please refer to publication SS-APG006-EN for complete details and examples.**

For complete equipment / combination selections, installation instructions and warranty information, please refer to Product Data/Ratings and/or Installers Guides and Limited Warranty Handbooks.

## Subcooling Charging

### Subcooling Charging in Cooling Above 55°F Outdoor Ambient Temperature

The manufacturer has always recommended installing American Standard approved matched indoor and outdoor systems.

All split systems are AHRI rated with TXV or EEV indoor systems.

The benefits of installing approved indoor and outdoor split systems are maximum efficiency, optimum performance and the best overall reliability.

The following charging methods are therefore prescribed for systems with indoor TXVs or EEVs.

1. Subcooling (in the cooling mode) is the only recommended method of charging between 55° and 120° ambient temperatures.
2. When charging for ambient temperatures above 120°, charge to 10° subcooling. It is important to return when outdoor ambient temperature is between 55° and 120° to verify system charge per these instructions.
3. For best results—the indoor temperature should be kept between 70° to 80°. Add system heat if needed.
4. Locate the designated subcooling target from the unit nameplate.
5. Run the system using the Charging Mode-Cooling test mode found in the 950 control. This is the only approved method for setting the system charge level. To access Charge Mode-Cooling from the 950 control home screen go to:
  - ▶ Menu
  - ▶ Service
  - ▶ Technician Access (hold for 5 seconds)
  - ▶ Proceed
  - ▶ Test Mode
  - ▶ Variable Speed
  - ▶ Charging Mode-Cooling and follow the on-screen prompts. Charging Mode-Cooling and follow the on-screen prompts.
6. At startup, or any time charge is removed or added, the system must be operated for a minimum of (20) minutes to stabilize before accurate measurements can be made.
7. Measure Liquid Line Temperature and Refrigerant Pressure at service valves.
8. Determine total refrigerant line length, and height (lift) if indoor section is above the condenser. Follow the Subcool Charging Corrections Table to calculate additional subcooling target value.
9. Locate your liquid line temperature in the left column of the table, and the intersecting liquid line gage pressure under the subcool selection column. Add refrigerant to raise the pressure to match the table, or remove refrigerant to lower the pressure. Always wait (20) minutes for the system conditions to stabilize before adjusting charge again.
10. When system is correctly charged, you can refer to System Pressure Curves to verify typical performance.

**Table AC/IN-8-A — 024 Units**

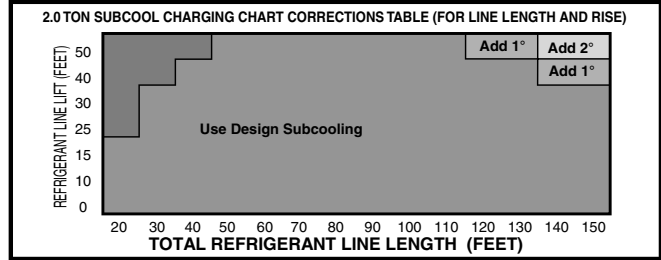

**Table AC/IN-8-B — 036 Units**

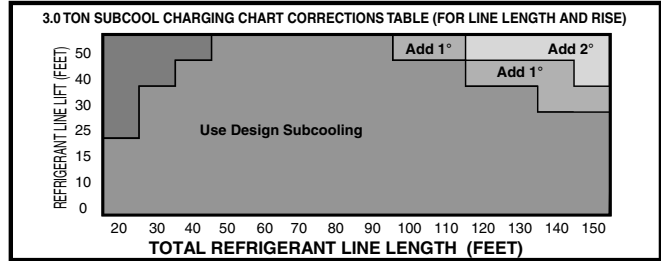

**Table AC/IN-8-C — 048 Units**

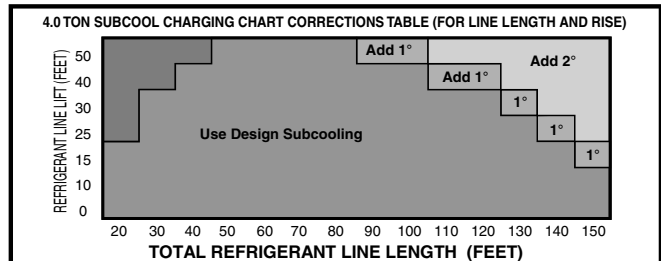

**Table AC/IN-8-D — 060 Units**

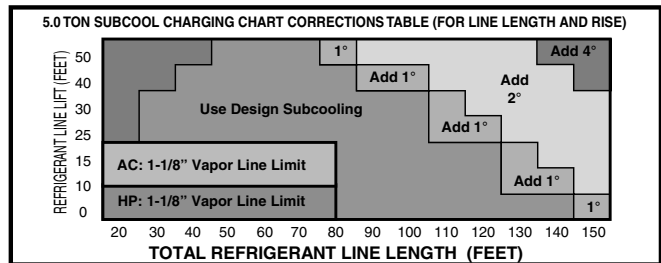

NOTE: 150 ft. length is approved ONLY with 7/8" vapor lines.

## B. Weigh-in Method

Weigh-in Method can be used for the initial installation or anytime a system charge is being replaced. Weigh-In Method can also be used when power to the equipment is not available or operation conditions (indoor/outdoor temperatures) are not in range to verify with the subcooling charging method. (Tables 15-17 assume 3/8" Liquid Line.)

**Table AC/IN-9-A**

18 SEER HEAT PUMPS			
A	B	C	D
Model	Factory Charge	Charge Adder for Indoor Coil	Charge Multiplier for Interconnecting Refrigerant Tube Length
024	7lb, 6oz	6oz	0.6oz per foot
036	8lb, 3oz	8oz	0.6oz per foot
037	9lb, 8oz	12oz	0.6oz per foot
048	9lb, 13oz	13oz	0.6oz per foot
049	10lb, 12oz	15oz	0.6oz per foot
060	11lb, 14oz	1lb, 2oz	0.6oz per foot

**Table AC/IN-9-B**

20 SEER HEAT PUMPS			
A	B	C	D
Model	Factory Charge	Charge Adder for Indoor Coil	Charge Multiplier for Interconnecting Refrigerant Tube Length
024	7lb, 6oz	6oz	0.6oz per foot
036	9lb, 8oz	12oz	0.6oz per foot
048	10lb, 12oz	15oz	0.6oz per foot
060	11lb, 14oz	1lb, 2oz	0.6oz per foot

Note: The only mode approved for setting or validating system charge is using Charging Mode-Cooling. Charging Mode-Cooling is a variable speed test mode found in the 950/850 comfort control Technician Menu. Outdoor Temperature must be between 55°F and 120°F with Indoor Temperature kept between 70°F and 80°F.

**Table AC/IN-9-C**

18 & 20 SEER AIR CONDITIONERS			
A	B	C	D
Model	Factory Charge	Charge Adder for Indoor Coil	Charge Multiplier for Interconnecting Refrigerant Tube Length
024	7lb, 6oz	6oz	0.6oz per foot
036	7lb, 14oz	7oz	0.6oz per foot
048	11lb, 1oz	1lb, 0oz	0.6oz per foot
060	11lb, 14oz	1lb, 2oz	0.6oz per foot

STEP 1 - Measure in feet and record the distance between the outdoor unit and the indoor unit. Include the entire length of the tubing from the service valve to the IDU.  
 STEP 2 - Record the Charge Multiplier from Column D.  
 STEP 3 - Multiply the total length of refrigerant tubing from Step 1 times the value from Step 2. Record the result.  
 STEP 4 - Locate the outdoor equipment size from Column A of the appropriate table above and record the value found in Column C.  
 STEP 5 - Add the values from Step 3 and Step 4 and record the resulting value. This is the amount of refrigerant to weigh-in prior to opening the service valves.

**New Installation Weigh-In Method Worksheet**

(Step 1) Line Length (ft) \_\_\_\_\_  
 (Step 2) Value from Column D      x \_\_\_\_\_  
 (Step 3) Step 1 times Step 2      = \_\_\_\_\_  
 (Step 4) Charge Adder (column C)    + \_\_\_\_\_  
 (Step 5) Refrigerant (Steps 3+4)    = \_\_\_\_\_

STEP 1 - Measure in feet and record the distance between the outdoor unit and the indoor unit. Include the entire length of the tubing from the service valve to the IDU.  
 STEP 2 - Record the Charge Multiplier from Column D.  
 STEP 3 - Multiply the total length of refrigerant tubing from Step 1 times the value from Step 2. Record the result.  
 STEP 4 - Locate the outdoor equipment size from Column A of the appropriate table above and record the value found in Column C.  
 STEP 5 - Record the value in Column B.  
 STEP 6 - Add the values from Step 3, Step 4 and Step 5 and record the resulting value. This is the amount of refrigerant to weigh-in.

**Sealed-System Weigh-In Method Worksheet**

(Step 1) Line Length (ft) \_\_\_\_\_  
 (Step 2) Value from Column D      x \_\_\_\_\_  
 (Step 3) Step 1 times Step 2      = \_\_\_\_\_  
 (Step 4) Charge Adder (column C)    + \_\_\_\_\_  
 (Step 5) Factory Charge (column B)    + \_\_\_\_\_  
 (Step 6) Refrigerant (Steps 3+4+5) = \_\_\_\_\_



# Split Systems with Variable Speed Compressor

**Table AC/IN-10-A — Charge Chart**

R-410A REFRIGERANT CHARGING CHART							
LIQUID TEMP (°F)	DESIGN SUBCOOLING (°F)						
	8	9	10	11	12	13	14
	LIQUID GAGE PRESSURE (PSI)						
55	179	182	185	188	191	195	198
60	195	198	201	204	208	211	215
65	211	215	218	222	225	229	232
70	229	232	236	240	243	247	251
75	247	251	255	259	263	267	271
80	267	271	275	279	283	287	291
85	287	291	296	300	304	309	313
90	309	313	318	322	327	331	336
95	331	336	341	346	351	355	360
100	355	360	365	370	376	381	386
105	381	386	391	396	402	407	413
110	407	413	418	424	429	435	441
115	435	441	446	452	458	464	470
120	464	470	476	482	488	495	501
125	495	501	507	514	520	527	533

Refer to Service Facts or Installer's Guide for charging method.

From Dwg. D154557P01 Rev. 3

**Table AC/IN-10-B — Line Sizes Rated Line Sizes**

MODEL	RATED LINE SIZE		SERVICE VALVE CONNECTION SIZE	
	Vapor Line	Liquid Line	Vapor Line	Liquid Line
HP 4A6V				
HP 024	5/8" (a)	3/8"	5/8"	3/8"
HP 036	3/4" (a)	3/8"	3/4"	3/8"
HP 037	3/4" (a)	3/8"	3/4"	3/8"
HP 048	7/8" (a)	3/8"	7/8"	3/8"
HP 049	7/8" (a)	3/8"	7/8"	3/8"
HP 060	1-1/8"(b)	3/8"	7/8"	3/8"
AC 4A7V				
AC 024	5/8" (a)	3/8"	5/8"	3/8"
AC 036	3/4" (a)	3/8"	3/4"	3/8"
AC 048	7/8"(a)	3/8"	7/8"	3/8"
AC 060	1-1/8"(c)	3/8"	7/8"	3/8"

- (a) The maximum length of refrigerant lines from outdoor to indoor unit must NOT exceed 150 feet. The maximum vertical change must NOT exceed 50 feet.
- (b) The maximum length of refrigerant lines from outdoor to indoor unit must NOT exceed 80 feet. The maximum vertical change must NOT exceed 10 feet.
- (c) The maximum length of refrigerant lines from outdoor to indoor unit must NOT exceed 80 feet. The maximum vertical change must NOT exceed 25 feet.

**Table AC/IN-10-C — Alternate Line Sizes**

MODEL	LINE SIZE		SERVICE VALVE CONNECTION SIZE	
	Vapor Line	Liquid Line	Vapor Line	Liquid Line
HP 4A6V				
HP 024	3/4" (a)	5/16" (d)	5/8"	3/8"
HP 036	5/8" (a)	5/16" (d)	3/4"	3/8"
	7/8" (c)	5/16" (d)	3/4"	3/8"
HP 037	5/8" (a)	5/16" (d)	3/4"	3/8"
	7/8" (c)	5/16" (d)	3/4"	3/8"
HP 048	3/4" (a)	3/8"	7/8"	3/8"
HP 049	3/4" (a)	3/8"	7/8"	3/8"
HP 060	3/4" (a)	3/8"	7/8"	3/8"
	7/8" (a)	3/8"	7/8"	3/8"
AC 4A7V				
AC 024	3/4" (a)	5/16"	5/8"	3/8"
AC 036	5/8" (a)	5/16"	3/4"	3/8"
	7/8" (c)	5/16"	3/4"	3/8"
AC 048	3/4" (a)	3/8"	7/8"	3/8"
AC 060	3/4" (a)	3/8"	7/8"	3/8"
	7/8" (a)	3/8"	7/8"	3/8"

- (a) The maximum length of refrigerant lines from outdoor to indoor unit must NOT exceed 150 feet. The maximum vertical change must NOT exceed 50 feet.
- (b) The maximum length of refrigerant lines from outdoor to indoor unit must NOT exceed 80 feet. The maximum vertical change must NOT exceed 10 feet.
- (c) The maximum length of refrigerant lines from outdoor to indoor unit must NOT exceed 80 feet. The maximum vertical change must NOT exceed 25 feet.
- (d) If using 5/16", the change adder is 0.0270 lbs/ft (0.43 oz/ft).

# Branch Circuit Wire Sizing Table/ Heater De-Rating Chart

## BRANCH CIRCUIT WIRE SIZING TABLE

(Based on 2% Voltage Drop)

Chart is based on 75° C. wire. (Types FEPW, RH, RHW, THHW, THW, THWN, XHHW, USE, AND ZW.)  
Use Chart For Wire Sizing Only. Refer To Electrical Code, (Or Product Specs.) For Fuse Sizing

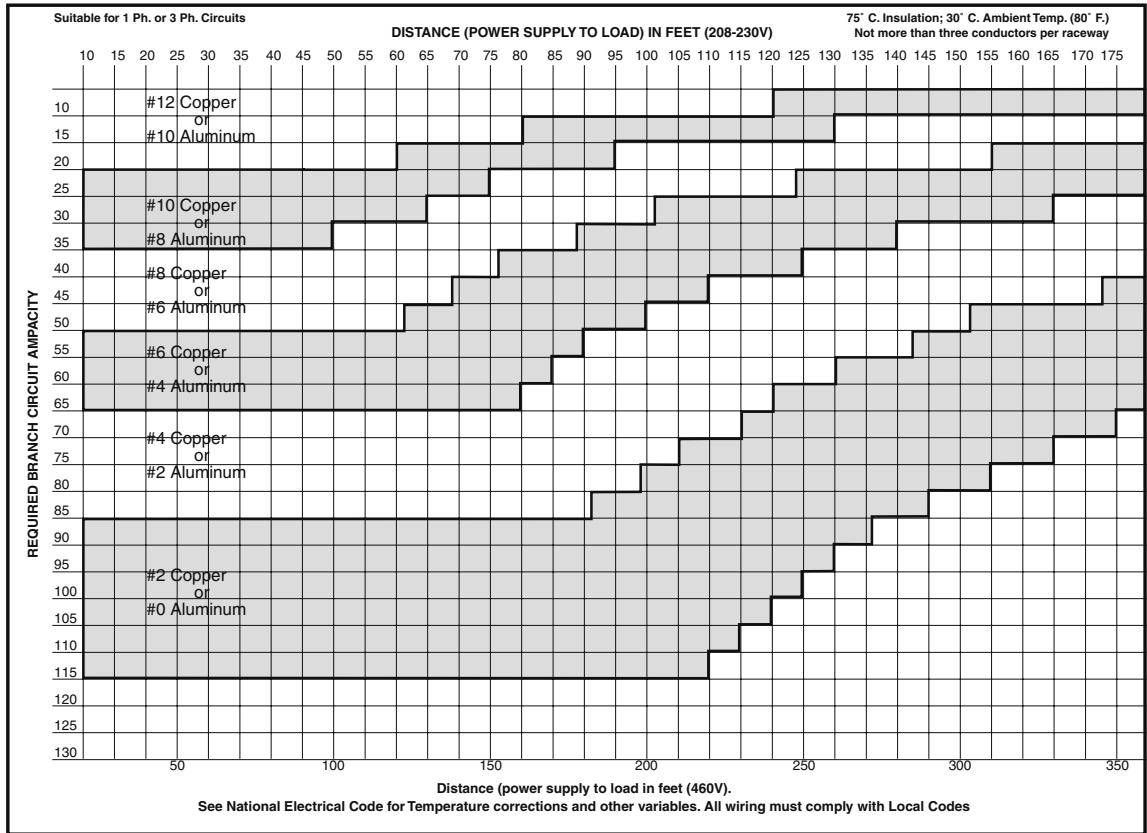

## Heater De-Rating Chart

The output of electric heaters, applied at voltages other than the rated 240 or 480 volts, can be easily determined with the use of this chart.

### ELECTRIC HEATER DE-RATING CHART

(for 240V or 480V Rated Heaters Installed on Lower Voltage Systems)

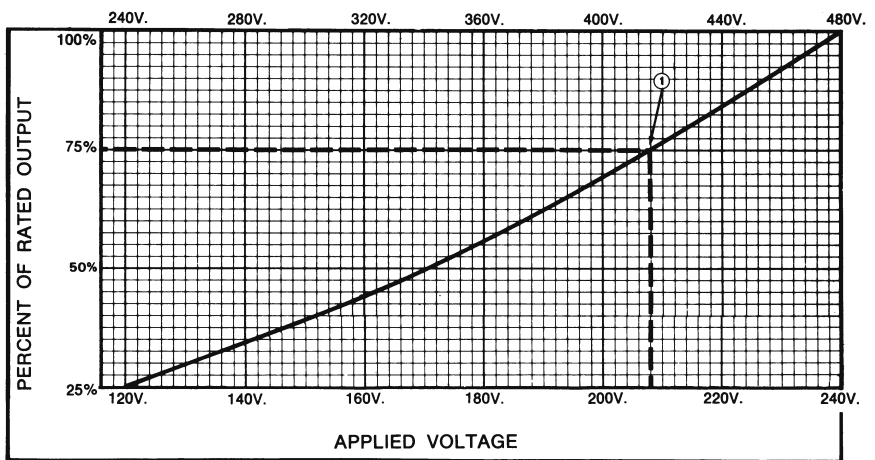

① EXAMPLE: Calculated Heat Loss — 29,200 BTUH Power Supply — 208V.  
The chart indicates that any 240V heater will deliver 75% of its rated capacity at 208V.

$$\frac{29,200 \text{ BTUH}}{.75} = 39,000 \text{ BTUH} \quad \left\{ \begin{array}{l} \text{Select a heater having AT LEAST 39,000 BTUH} \\ \text{capacity at 240V.} \end{array} \right.$$

For complete equipment / combination selections, installation instructions and warranty information, please refer to Product Data/Ratings and/or Installers Guides and Limited Warranty Handbooks.

# Basic Air Conditioning Formulas

## Basic Air Conditioning Formulas

TO DETERMINE	EXPRESSED AS	COOLING	HEATING and/or HUMIDIFYING
Total Airflow	CFM <sub>T</sub>	1. $CFM_T = \frac{N_T V}{60 \text{ min./hr.}}$	1. $CFM_T = \frac{N_T V}{60 \text{ min./hr.}}$
Infiltration or Ventilation	CFM <sub>O</sub>	2. $CFM_O = \frac{N_O V}{60 \text{ min./hr.}}$	2. $CFM_O = \frac{N_O V}{60 \text{ min./hr.}}$
Number of Air Changes Per Hour – Total	N <sub>T</sub>	3. $N_T = \frac{CFM_T (60 \text{ min./hr.})}{V}$	3. $N_T = \frac{CFM_T (60 \text{ min./hr.})}{V}$
Number of Air Changes Per Hour – Outdoor Air	N <sub>O</sub>	4. $N_O = \frac{CFM_O (60 \text{ min./hr.})}{V}$	4. $N_O = \frac{CFM_O (60 \text{ min./hr.})}{V}$
Total Heat (H <sub>T</sub> )	Btuh	5. $H_T = CFM_T \times 4.5 \times (h_1 - h_2) = \text{Btuh}$	6. $H_T = CFM_T \times 4.5 \times (h_2 - h_1) = \text{Btuh}$
Sensible Heat (H <sub>S</sub> )	Btuh	7. $H_S = CFM_T \times 1.08 \times (T_1 - T_2) = \text{Btuh}$	8. $H_S = CFM_T \times 1.08 \times (T_2 - T_1) = \text{Btuh}$
Latent Heat (H <sub>L</sub> )	Btuh	9. $H_L = CFM_T \times .68 \times (W_1 - W_2) = \text{Btuh}$	10. $H_L = CFM_T \times .68 \times (W_2 - W_1) = \text{Btuh}$
Entering Air Temperature (T <sub>1</sub> ) (Mixed Air)	°F. D.B.	11. $T_1 = t_1 + \frac{CFM_O}{CFM_T} \times (t_2 - t_1) = \text{°F.D.B.} \text{ ①}$ ① If duct heat gain is a factor, add to T <sub>1</sub> : $\frac{\text{Duct Heat Gain (Btuh)}}{CFM_T \times 1.08}$	12. $T_1 = t_1 - \frac{CFM_O}{CFM_T} \times (t_1 - t_2) = \text{°F.D.B.} \text{ ②}$ ② If duct heat loss is a factor, subtract from T <sub>1</sub> : $\frac{\text{Duct Heat Loss (Btuh)}}{CFM_T \times 1.08}$
Leaving Air D.B. Temperature (T <sub>2</sub> )	°F. D.B.	13. $T_2 = T_1 - \frac{H_S}{CFM_T \times 1.08} = \text{°F.D.B.}$	14. $T_2 = T_1 + \frac{H_S}{CFM_T \times 1.08} = \text{°F.D.B.}$
Required Airflow	CFM <sub>T</sub>	15. $CFM_T = \frac{H_S (\text{total})}{1.08 \times (T_1 - T_2)} = \text{CFM}$ OR $CFM_T = \frac{H_S (\text{internal}) \text{ ③}}{1.08 \times (t_1 - T_2)} = \text{CFM}$ ③ Sensible load of outside air not included	16. $CFM_T = \frac{H_S}{1.08 \times (T_2 - T_1)} = \text{CFM}$
Enthalpy – Leaving Air (h <sub>2</sub> )	Btu/lb. dry air	17. $h_2 = h_1 - \frac{H_T}{CFM_T \times 4.5} = \text{Btu/lb. dry air}$	18. $h_2 = h_1 + \frac{H_T}{CFM_T \times 4.5} = \text{Btu/lb. dry air}$
Leaving Air W.B. Temperature	°F.W.B.	19. Refer to Enthalpy Table and read W.B. temperature corresponding to enthalpy of leaving air (h <sub>2</sub> ) (see #17).	20. Refer to Enthalpy Table and read W.B. temperature corresponding to enthalpy of leaving air (h <sub>2</sub> ) (see #18).
Heat Required to Evaporate Water Vapor Added to Ventilation Air	Btuh	21. $H_L = CFM_O \times .68 (W_3 - W_O) = \text{Btuh}$	22. $H_L = CFM_O \times .68 (W_3 - W_O) = \text{Btuh}$
Humidification Requirements	Lbs. water/hr.	23. $\left( \begin{array}{l} \text{Make up} \\ \text{Moisture} \end{array} \right) = \frac{\text{Excess Latent Capacity of System} \times \% \text{ Run Time}}{1060 \text{ Btu/lb.}} = \text{lbs./hr.}$ (Industrial Process Work)	24. $\left( \begin{array}{l} \text{Make up} \\ \text{Moisture} \end{array} \right) = \frac{H_L \text{ loss Btuh (see #22)}}{1060 \text{ Btu/lb.}} = \text{lbs./hr.}$

LEGEND	DERIVATION OF AIR CONSTANTS
<p>CFM<sub>T</sub> = Total airflow cubic feet/min.            CFM<sub>O</sub> = Outdoor air cubic feet/min.            N<sub>T</sub> = Total air changes per hour            N<sub>O</sub> = Outdoor air, air changes per hour            V = Volume of space cubic feet            H<sub>T</sub> = Total heat Btuh            H<sub>S</sub> = Sensible heat Btuh            H<sub>L</sub> = Latent heat Btuh            * h<sub>1</sub> = Enthalpy or total heat of entering air            * h<sub>2</sub> = Enthalpy or total heat of leaving air            T<sub>1</sub> = Temperature of entering air            T<sub>2</sub> = Temperature of leaving air            T<sub>adp</sub> = Apparatus dewpoint            t<sub>1</sub> = Indoor design temperature            t<sub>2</sub> = Outdoor design temperature            W<sub>1</sub> = Grains of water/lb. of dry air at entering condition            W<sub>2</sub> = Grains of water/lb. of dry air at leaving condition            W<sub>3</sub> = Grains of water/lb. of dry air at indoor design conditions            W<sub>O</sub> = Grains of water/lb. of dry air at outdoor design conditions</p>	<p>The air constants below apply specifically to standard air which is defined as dry air at 70°F and 14.7 P.S.I.A. (29.92 in. mercury column). They can, however, be used in most cooling calculations unless extremely precise results are desired.</p> <p>4.5 (To convert CFM to lbs./hr.)</p> <p><math>4.5 = \frac{60 \text{ min./hr.}}{13.33}</math> or <math>60 \times .075</math></p> <p>Where 13.33 is the specific volume of standard air (cu.ft./lb.) and .075 is the density (lbs./cu.ft.)</p> <p><math>1.08 = \frac{.24 \times 60}{13.33}</math> or <math>.24 \times 4.5</math></p> <p>.24 BTU = specific heat of standard air (BTU/LB./°F)</p> <p><math>.68 = \frac{.60}{13.33} \times \frac{1060}{7000}</math> or <math>4.5 \times \frac{1060}{7000}</math></p> <p>Where: 1060 = Average Latent Heat of water vapor (BTU/LB.). 7000 = Grains per lb.</p>

\* See Enthalpy of air (Total Heat Content of Air) Table for exact values.

# Low Ambient Accessories Cooling and Heating Models

**Table AC/IN-13-A — Low Ambient Accessories Cooling Models**

Low Ambient Accessory For American Standard Residential Cooling Units													
Cooling Unit	55°F	30°F to 55°F				0°F to 30°F or 20°F to 30°F - Please Reference Lowest Approved Outdoor Operating Temperature per Model Family Table							
	As Manufactured	AY28X079	TXV-NB	CCHT	BAYACHP024	BAYLOAM103*	BAYLOAM107*	AY28X079	TXV-NB	Start Kit	Compressor Crankcase Heater	Windshield	Liquid Line Solenoid Valve
4TTA3 <sup>①</sup>	X	X	X	X		X		X	X	N/A	X	X	X
4TTB3 <sup>①</sup> 4TTB4 4TTB6	X	X	X	X		X		X	X	X	X	X	X
4A7A3 <sup>⑤</sup> 4A7A5	X	X	X	X		X		X	X	X	X	X	X
4A7A4-L <sup>⑤</sup>	X	X	X	X		X		X	X	X	X	X	X
4A7A6-H,J 4A7A7 <sup>⑤</sup>	X	X	X	X		X		X	X	X	X	X	X
4A7Z0 <sup>③</sup>	X	Not Approved											
4A7V8	X	Not Approved											
4A7V00	X	Not Approved											

**Table AC/IN-13-B — Low Ambient Accessories Heating Models**

Low Ambient Accessory For American Standard Residential Heat Pump Units Operating in Cooling													
Heat Pump Unit	55°F	30°F to 55°F				0°F to 30°F or 20°F to 30°F - Please Reference Lowest Approved Outdoor Operating Temperature per Model Family Table							
	As Manufactured	AY28X079	TXV-NB	CCHT	BAYACHP024	BAYLOAM103*	BAYLOAM107*	AY28X084	TXV-NB	Start Kit	Compressor Crankcase Heater	Windshield	Liquid Line Solenoid Valve
4TWA3 <sup>①</sup>	X	X	X	X		X		X	X	N/A	X	X	
4TWB3 <sup>①</sup> 4TWB4	X	X	X	X		X		X	X	X	X	X	
4A6H3 <sup>⑤</sup> 4A6H4-D 4A6H5	X	X	X	X		X	4A6H4024	X	X	X	X	X	
4A6H6-H <sup>⑤</sup>	X	X	X	X			X	X	X	X	X	X	
4A6H7 <sup>⑤</sup>	X	X	X	X		X		X	X	X	X	X	
4A6Z0 <sup>③</sup>	X	Not Approved											
4A6V8	X	Not Approved											
4A6V00	X	Not Approved											

Charts are for quick reference only. For complete application guidelines, consult the specific SSC-APG\*\*\*

- ① Reference AMSSP-APG001-EN for complete Low Ambient Guidelines.
- ② Reference AMSSP-APG002-EN for complete Low Ambient Guidelines.
- ③ Reference SSC-APG008-EN for complete Low Ambient Guidelines.
- ④ Reference APP-APG014-EN.
- ⑤ Reference SSC-APG012A-EN.

\* DO NOT apply BAYLOAM103/107 to model tonnages with variable speed condenser fan motors.

**Table AC/IN-13-C — Lowest Approved Outdoor Operating Temperature for Cooling Operation per Model Family Table**

Model Family	Lowest Approved OD Ambient	
	AC	HP
4A7V8 / 4A6V8 / 4A7V00 / 4A6V00	55°F	55°F
4A7Z0 / 4A6Z0	55°F	55°F
4TTA3 / 4TWA3	0°F	0°F
4TTB3 / 4TWB3	0°F	0°F
4TTB4 / 4TWB4 / 4TTB6 / 4TWB6	20°F	20°F
4A7A3 / 4A6H3	0°F	0°F
4A7A4 / 4A6H4 / 4A6H5	20°F	10°F
4A7A6 / 4A6H6 **	20°F	10°F
4A7A7 / 4A6H7	20°F	10°F

\*\* Models with variable speed condenser motors are approved to 30°F

**For a detailed Application Bulletin on required accessories and wind shields for low outdoor ambient operation, please contact your Territory Manager or Local FSR.**

## Wind Shields

Wind Shields are required to block prevailing winds across condenser coil. In applications where cooling

operation is required to 0°F, wind shields are a Must. Use the following guidelines for your application.

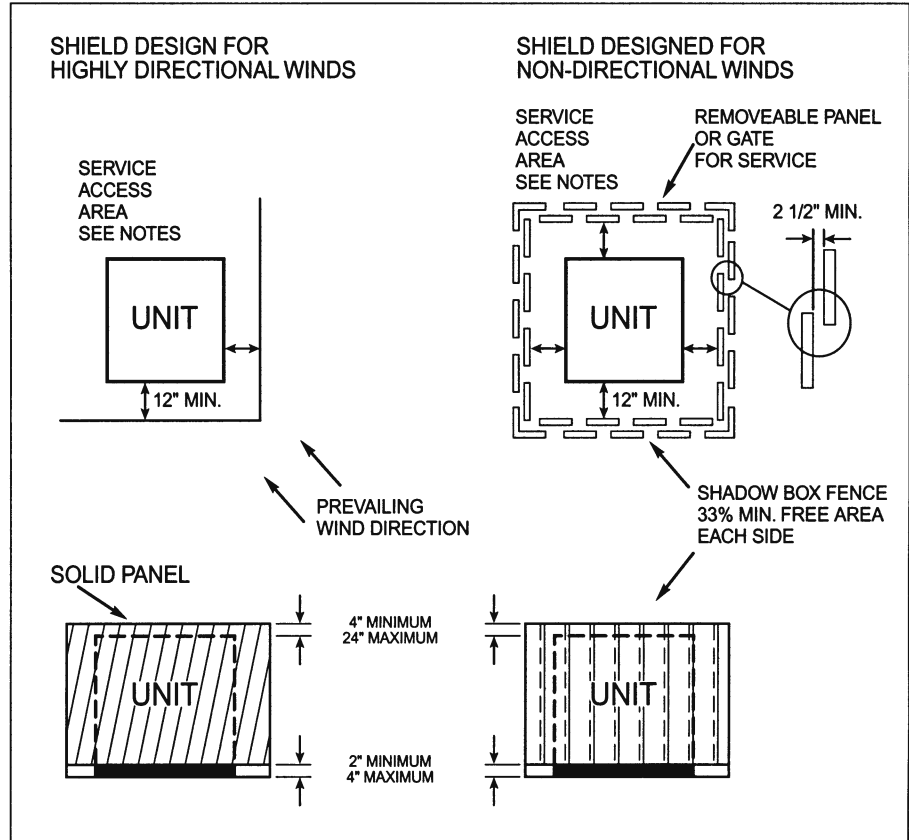

Notes:  
Minimum working clearance must be in compliance with the National Electric Code. Currently, the minimum clearance between a wood or suitable grounding material type fence requires minimum 3 feet. If other material is used to form the windshield, the minimum space may be increased to 3.5 feet. Please consult the 2006 Edition of the National Electric Code, Article 110 for the most up to date information, please refer to the most current National Electric Code.

**For a detailed Application Bulletin on required accessories and wind shields for low outdoor ambient operation, please contact your Territory Manager or Local FSR.**

# Split System Cooling Three Phase – 6-25 Tons, R-410A

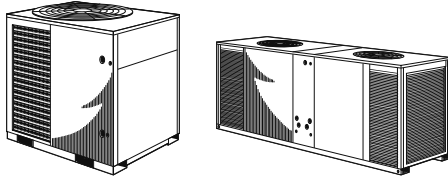

**TTA – 6-25 Tons**

- ReliaTel™ controls option
- (1) Scroll compressor (TTA073-120G)
- (2) Scroll compressors (TTA120H-240H) with independent refrigerant circuits
- (2) Manifolder scroll compressors (TTA120J, 180F-300J)
- Single point power
- Compressor motor overload protection
- Compressor discharge temperature limit switch
- Control transformer
- High and low pressure cut-out switches
- Liquid line filter drier, factory installed
- Service valves with pressure taps
- Electrical phase reversal protection
- Internal pressure relief valves
- Holding charge (Dry Nitrogen)
- All Aluminum microchannel coil
- Low ambient cooling to 50°F as shipped
- Low ambient cooling to 0°F with accessory head pressure control
- Mounting/lifting rails under base
- UL listed
- **5-year compressor warranty**
- **1-year limited parts warranty**
- **Optional Extended Warranties**

1 2 3 4 5 6 7 8 9 10 11 12  
T T A 0 9 0 G 3 0 0 A 0

**Compressor Type**

- G = Single Compressor/Single Refrigerant Circuit, R-410A
- H = Dual Compressor/Dual Refrigerant Circuit, R-410A
- J = Dual Compressor/Single Manifolder Refrigerant Circuit, R-410A

**Factory-Installed Options**

- 00 = Packed Stock
- 0S = Complete Coat Coated Coil
- 0R = ReliaTel™ Controls
- 0T = ReliaTel™ Controls and Complete Coat Coated Coil

1 2 3 4 5 6 7 8 9 10 11 12  
T T A 0 9 0 G 3 0 0 A 0

**Compressor Type**

- G = Single Compressor/Single Refrigerant Circuit, R-410A
- H = Dual Compressor/Dual Refrigerant Circuit, R-410A
- J = Dual Compressor/Single Manifolder Refrigerant Circuit, R-410A

**Factory-Installed Options**

- H0 = Hail Guard
- HS = Hail Guard and Complete Coat Coated Coil
- HR = Hail Guard and ReliaTel™ Controls
- HT = Hail Guard and ReliaTel™ Controls with Complete Coat Coated Coil

**Table LSC-1-A — TTA Split System Cooling — Single Compressor — R-410 Refrigerant**

Model Number	Power Supply	Nom. Cap. Cooling (BTUH)	Uncrated Dimensions(in.)			Shipping Weight (lbs.)	Sound <sup>①</sup> Rating	MCA*	Max. Fuse*	Line Size	
			H	W	L					OD Gas	OD Liq.
TTA073G300A	208-230/3/60	76,000	46	45	38	310	84	30.5	50	1 <sup>1</sup> / <sub>8</sub>	1/2
TTA090G300A	208-230/3/60	95,000	46	45	38	320	83	34.4	45	1 <sup>1</sup> / <sub>8</sub>	1/2
TTA120G300A	208-230/3/60	120,000	46	55	42	416	90	42.6	60	1 <sup>1</sup> / <sub>8</sub>	1/2
TTA073G400A	460/3/60	76,000	46	45	38	310	84	13	20	1 <sup>1</sup> / <sub>8</sub>	1/2
TTA090G400A	460/3/60	95,000	46	45	38	320	83	17.7	20	1 <sup>1</sup> / <sub>8</sub>	1/2
TTA120G400A	460/3/60	120,000	46	55	42	416	90	23.4	30	1 <sup>1</sup> / <sub>8</sub>	1/2
TTA073GW00A	575/3/60	76,000	46	45	38	310	84	10.5	15	1 <sup>1</sup> / <sub>8</sub>	1/2
TTA090GW00A	575/3/60	95,000	46	45	38	320	83	14.5	20	1 <sup>1</sup> / <sub>8</sub>	1/2
TTA120GW00A	575/3/60	120,000	46	55	42	416	90	17.5	25	1 <sup>1</sup> / <sub>8</sub>	1/2

**Table LSC-1-B — TTA Split System Cooling — Dual Compressors with Two Sets of Refrigerant Circuits — R-410 Refrigerant**

Model Number	Power Supply	Nom. Cap. Cooling (BTUH)	Uncrated Dimensions(in.)			Shipping Weight (lbs.)	Sound <sup>①</sup> Rating	MCA*	Max. Fuse*	Line Size	
			H	W	L					OD Gas	OD Liq.
TTA090H300A	208-230/3/60	95,000	46	45	38	384	91	36	50	1 <sup>1</sup> / <sub>8</sub>	1/2
TTA120H300A	208-230/3/60	124,000	46	55	42	428	91	41	45	1 <sup>1</sup> / <sub>8</sub>	1/2
TTA150H300A	208-230/3/60	153,000	52	55	42	514	91	56	70	1 <sup>1</sup> / <sub>8</sub>	1/2
TTA180H300A	208-230/3/60	186,000	52	96	48	750	93	67	90	1 <sup>3</sup> / <sub>8</sub>	1/2
TTA240H300A	208-230/3/60	256,000	52	96	48	904	94	98	125	1 <sup>3</sup> / <sub>8</sub>	1/2
TTA090H400A	460/3/60	95,000	46	45	38	384	91	16.9	20	1 <sup>1</sup> / <sub>8</sub>	1/2
TTA120H400A	460/3/60	124,000	46	55	42	428	91	20.1	25	1 <sup>1</sup> / <sub>8</sub>	1/2
TTA150H400A	460/3/60	153,000	52	55	42	514	91	27	35	1 <sup>1</sup> / <sub>8</sub>	1/2
TTA180H400A	460/3/60	186,000	52	96	48	750	93	33	40	1 <sup>3</sup> / <sub>8</sub>	1/2
TTA240H400A	460/3/60	256,000	52	96	48	904	94	47	60	1 <sup>3</sup> / <sub>8</sub>	1/2
TTA090HW00A	575/3/60	95,000	46	45	38	384	91	12.2	15	1 <sup>1</sup> / <sub>8</sub>	1/2
TTA120HW00A	575/3/60	124,000	46	55	42	428	91	15.5	20	1 <sup>1</sup> / <sub>8</sub>	1/2
TTA150HW00A	575/3/60	153,000	52	55	42	514	91	20	25	1 <sup>1</sup> / <sub>8</sub>	1/2
TTA180HW00A	575/3/60	186,000	52	96	48	750	93	25	30	1 <sup>3</sup> / <sub>8</sub>	1/2
TTA240HW00A	575/3/60	256,000	52	96	48	904	94	39	50	1 <sup>3</sup> / <sub>8</sub>	1/2

① Sound rating show is tested in accordance with ARI Standard 270 or 370.

\* Information subject to change. Please confirm with current Product Data/Service Facts for current factory production.

# Split System Cooling

## Three Phase – 6-25 Tons, R-22

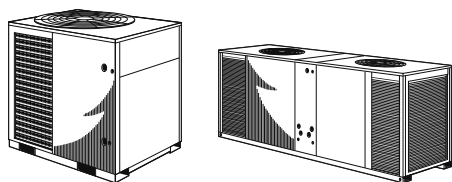

**TTA – 6-25 Tons**

- ReliaTel™ controls option (Heat Pump only)
- Single point power
- Compressor motor overload protection
- Compressor discharge temperature limit switch
- Control transformer
- High and low pressure cut-out switches
- Liquid line filter drier, factory installed
- Service valves with pressure taps
- Electrical phase reversal protection
- Internal pressure relief valves
- Holding charge (Dry Nitrogen)
- Copper tube, aluminum plate fin coils
- Low ambient cooling to 50°F as shipped
- Low ambient cooling to 0°F with accessory head pressure control
- Mounting/lifting rails under base
- UL listed
- **1-year limited parts warranty**
- **Optional Extended Warranties**

1 2 3 4 5 6 7 8 9 10 11 12  
T T A 0 9 0 A 3 0 0 A 0

**Compressor Type**  
A=Single Compressor/Single Circuit R-22  
B=Dual Compressor/Dual Circuit R-22

**Factory-Installed Options**  
00=ReliaTel™ Controls

**Table LSC-2-A — TTA Split System Heat Pumps - Single Compressors with Single Refrigerant Circuits - R-22 Refrigerant**

Model Number	Power Supply	Nom. Cap. Cooling (BTUH)	Uncrated Dimensions(in.)			Shipping Weight (lbs.)	Sound <sup>①</sup> Rating	MCA*	Max. Fuse*	Line Size	
			H	W	L					OD Gas	OD Liq.
TTA090A300G	208-230/3/60	90,000	39	36	42	363	83	31.1	45	1 <sup>3</sup> / <sub>8</sub>	5 <sup>5</sup> / <sub>8</sub>
TTA120A300G	208-230/3/60	120,000	45	40	52	467	90	42.6	60	1 <sup>3</sup> / <sub>8</sub>	1 <sup>1</sup> / <sub>2</sub>
TTA090A400G	460/3/60	90,000	39	36	42	363	83	15.2	25	1 <sup>3</sup> / <sub>8</sub>	1 <sup>1</sup> / <sub>2</sub>
TTA120A400G	460/3/60	120,000	45	40	52	467	90	21.9	30	1 <sup>3</sup> / <sub>8</sub>	1 <sup>1</sup> / <sub>2</sub>

**Table LSC-2-B — TTA Split System Heat Pumps - Dual Compressors with Dual Refrigerant Circuits - R-22 Refrigerant**

Model Number	Power Supply	Nom. Cap. Cooling (BTUH)	Uncrated Dimensions(in.)			Shipping Weight (lbs.)	Sound <sup>①</sup> Rating	MCA*	Max. Fuse*	Line Size	
			H	W	L					OD Gas	OD Liq.
TTA180B300G	208-230/3/60	180,000	46	45	95	850	93	60.4	80	1 <sup>3</sup> / <sub>8</sub>	1 <sup>1</sup> / <sub>2</sub>
TTA240B300G	208-230/3/60	240,000	46	45	95	970	94	77.7	100	1 <sup>3</sup> / <sub>8</sub>	1 <sup>1</sup> / <sub>2</sub>
TTA180B400G	460/3/60	180,000	46	45	95	850	93	29.5	40	1 <sup>3</sup> / <sub>8</sub>	1 <sup>1</sup> / <sub>2</sub>
TTA240B400G	460/3/60	240,000	46	45	95	970	94	39.9	50	1 <sup>3</sup> / <sub>8</sub>	1 <sup>1</sup> / <sub>2</sub>

① Sound rating show is tested in accordance with AHRI Standard 270 or 370.

\* Information subject to change. Please confirm with current Product Data/Service Facts for current factory production.

# Split System Cooling Three Phase – 6-25 Tons, R-410A

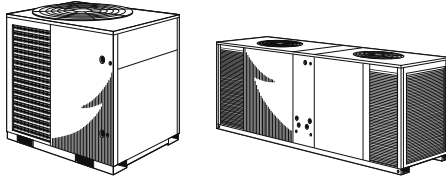

**TTA – 6-25 Tons**

- ReliaTel™ controls option
- (1) Scroll compressor (TTA073G-120G)
- (2) Scroll compressors (TTA120H-300H) with independent refrigerant circuits
- (2) Manifolder scroll compressors (TTA120J, 180-240J)
- Single point power
- Compressor motor overload protection
- Compressor discharge temperature limit switch
- Control transformer
- High and low pressure cut-out switches
- Liquid line filter drier, factory installed
- Service valves with pressure taps
- Electrical phase reversal protection
- Internal pressure relief valves
- Holding charge (Dry Nitrogen)
- Copper tube, aluminum plate fin coils
- Low ambient cooling to 50°F as shipped
- Low ambient cooling to 0°F with accessory head pressure control
- Mounting/lifting rails under base
- UL listed
- **5-year compressor warranty**
- **1-year limited parts warranty**
- **Optional Extended Warranties**

1 2 3 4 5 6 7 8 9 10 11 12  
T T A 0 9 0 G 3 0 0 A 0

1 2 3 4 5 6 7 8 9 10 11 12  
T T A 0 9 0 G 3 0 0 A 0

**Compressor Type**

- G = Single Microchannel Compressor/Single Refrigerant Circuit, R-410A
- H = Dual Microchannel Compressor/Dual Refrigerant Circuit, R-410A
- J = Dual Microchannel Compressor/Single Manifolder Refrigerant Circuit, R-410A

**Factory-Installed Options**

- 00 = Packed Stock
- 0S = Complete Coat Coated Coil
- 0R = ReliaTel™ Controls
- 0T = ReliaTel™ Controls and Complete Coat Coated Coil

**Compressor Type**

- G = Single Compressor/Single Refrigerant Circuit, R-410A
- H = Dual Compressor/Dual Refrigerant Circuit, R-410A
- J = Dual Compressor/Single Manifolder Refrigerant Circuit, R-410A

**Factory-Installed Options**

- H0 = Hail Guard
- HS = Hail Guard and Complete Coat Coil
- HR = Hail Guard and ReliaTel™ Controls
- HT = Hail Guard and ReliaTel™ Controls with Complete Coat Coil

**Table LSC-3-A — TTA Split System Cooling — Dual Manifolder Compressors with Single Refrigerant Circuits — R-410 Refrigerant**

Model Number	Power Supply	Nom. Cap. Cooling (BTUH)	Uncrated Dimensions(in.)			Shipping Weight (lbs.)	Sound <sup>①</sup> Rating	MCA*	Max. Fuse†	Line Size	
			H	W	L					Gas OD	Liq. OD
TTA120J300A	208-230/3/60	124,000	46	55	42	474	91	41	50	1 <sup>3</sup> / <sub>8</sub>	1/2
TTA180J300A	208-230/3/60	186,000	52	96	48	750	93	65	80	1 <sup>5</sup> / <sub>8</sub>	5/8
TTA240J300A	208-230/3/60	256,000	52	96	48	904	94	98	125	1 <sup>5</sup> / <sub>8</sub>	5/8
TTA300J300A	208-230/3/60	303,000	58	96	48	969	94	103	125	2 <sup>1</sup> / <sub>8</sub>	5/8
TTA120J400A	460/3/60	124,000	46	55	42	474	91	20	25	1 <sup>3</sup> / <sub>8</sub>	1/2
TTA180J400A	460/3/60	186,000	52	96	48	750	93	32	40	1 <sup>5</sup> / <sub>8</sub>	5/8
TTA240J400A	460/3/60	256,000	52	96	48	904	94	47	60	1 <sup>5</sup> / <sub>8</sub>	5/8
TTA300J400A	460/3/60	303,000	58	96	48	969	94	49	60	2 <sup>1</sup> / <sub>8</sub>	5/8
TTA120JW00A	575/3/60	124,000	46	55	42	474	91	15	20	1 <sup>3</sup> / <sub>8</sub>	1/2
TTA180JW00A	575/3/60	186,000	52	96	48	750	93	26	35	1 <sup>5</sup> / <sub>8</sub>	5/8
TTA240JW00A	575/3/60	256,000	52	96	48	904	94	39	50	1 <sup>5</sup> / <sub>8</sub>	5/8
TTA300JW00A	575/3/60	303,000	58	96	48	969	94	42	50	2 <sup>1</sup> / <sub>8</sub>	5/8

① Sound rating show is tested in accordance with ARI Standard 270 or 370.

\* Information subject to change. Please confirm with current Product Data/Service Facts for current factory production.



# Split System Cooling – R-410A

## Accessories Three Phase – 6-25 Tons

**Table LSC-4-A — R-410A Optional Accessories**

Model Number	Description	Used With
<b>Coil Guard</b>		
BAYGARD058A	Hail/Vandal Guard	TTA073G, TTA090G
BAYGARD059A	Hail/Vandal Guard	TTA120G/H/J
BAYGARD060A	Hail/Vandal Guard	TTA150H
BAYGARD061A	Hail/Vandal Guard	TTA180H/J, TTA240H/J
BAYGARD062A	Hail/Vandal Guard	TTA300J
<b>Hot Gas By-Pass</b>		
BAYHGBP010A	Universal Hot Gas Bypass Kit	TTA073G-TTA300J
<b>Isolators</b>		
BAYISLT004A	Rubber Isolator Floor (blue)	TTA073G-TTA090G
BAYISLT005A	Rubber Isolator Floor (black)	TTA120G/H/J
BAYISLT009A	Rubber Isolator Floor (red)	TTA150H, TTA180H/J
BAYISLT010A	Rubber Isolator Floor (green)	TTA240H/J, TTA300J
BAYISLT023A	Steel Spring Isolator Floor (red)	TTA073G, TTA090G, TTA120G
BAYISLT024A	Steel Spring Isolator Floor (black)	TTA120H/J, TTA150H, TTA180H/J
BAYISLT025A	Steel Spring Isolator Floor (yellow)	TTA240H/J, TTA300J
<b>Low Ambient</b>		
BAYLOAMU01A <sup>①②③④</sup>	On/Off Fan Control Mounted in External Enclosure (small cabinets)	TTA073-090 (all voltages)
BAYLOAMU02A <sup>②③④</sup>	On/Off Fan Control Mounted in Unit Control Box (large cabinets)	TTA120-300 (all voltages)
BAYLOAM335A <sup>③</sup>	Modulating ICM Head Pressure Control w/ 208-230V 0.5 HP Hi-Eff Motor (internal mount)	TTA073G3, TTA090G3
BAYLOAM336A <sup>③</sup>	Modulating ICM Head Pressure Control w/ 208-230V 1 HP Hi-Eff Motor (internal mount)	TTA120G3/H3/J3, TTA150H3, TTA180H3/J3, TTA240H3/J3, TTA300J3
BAYLOAM337A <sup>③</sup>	Modulating ICM Head Pressure Control w/ 208-230V 0.5 HP Hi-Eff Motor (internal mount)	TTA090H3
BAYLOAM435A <sup>③</sup>	Modulating ICM Head Pressure Control w/ 460V 0.5 HP Hi-Eff Motor (internal mount)	TTA073G4, TTA090G4
BAYLOAM436A <sup>③</sup>	Modulating ICM Head Pressure Control w/ 460V 1.0 HP Hi-Eff Motor (internal mount)	TTA120G4/H4/J4, TTA150H4, TTA180H4/J4, TTA240H4/J4, TTA300J4
BAYLOAM437A <sup>③</sup>	Modulating ICM Head Pressure Control w/ 380-460V 0.5 HP Hi-Eff Motor (internal mount)	TTA073H4, TTA090H4
BAYLOAMW36A <sup>③</sup>	Modulating ICM Head Pressure Control w/ 575V 1.0 HP Hi-Eff Motor (internal mount)	TTA120GW/HW/JW, TTA150HW, TTA180HW/JW, TTA240HW/FW, TTA300JW
BAYLOTR001A <sup>⑤</sup>	Additional Pressure Transducer for ICM Head Pressure Control	TTA120H/J, TTA150H
<b>Time Delay Relay</b>		
BAYRLAY002	Time Delay Relay	TTA090G-TTA300J
<b>BACnet™ Communications Interface</b>		
BAYBCIR001A	BACnet (BCI-R) Communications Interface	All

① Kit mounts external to the outdoor unit and operates by sensing ambient and liquid line temperatures.

② Cycles fan on/off, (no modulating).

③ Quantity of 1 required for each fan (2 total for TTA/TWA180-300).

④ ReliaTel™ requires onboard EDC function to be disabled when Bayloam is used, remove OA sensor from terminal J8-1&2.

⑤ BAYLOTR001A required when modulating BAYLOAM kits used with units that have 2 compressors and 1 condenser fan.

**Table LSC-5-A — ReliaTel™ Control Options**

Model Number	Description	Used With
ASYSTAT106A	Zone Sensor, Set Point, Fan System	TTA073-TTA300 with ReliaTel™ Controls
ASYSTAT107A	Zone Sensor, Set Point Adj, Fan, System, EH, LED	TTA073-TTA300
ASYSTAT108A	Zone Sensor, 2 Set Point, Fan System	TTA073-TTA300 with ReliaTel™ Controls
ASYSTAT109A	Zone Sensor, 2 Set Point Adj, Fan, System, EH, LED	TTA073-TTA300
ASYSTAT777A	Digital Programmable Zone Sensor with Night Setback	TTA073-TTA300 with ReliaTel™ Controls
BAYSENS050①	Wireless Zone Sensor	TTA073-TTA300 with ReliaTel™ Controls
BAYSENS073A	Room Sensor w/ Override and Cancel Button	TTA073-TTA300 with ReliaTel™ Controls
BAYSENS074A	Room Sensor w/ Temperature Adjustment and Override Button	TTA073-TTA300 with ReliaTel™ Controls
BAYSENS077A	Remote Sensor	ASYSTAT106A-ASYSTAT109A, ASYSTAT777A
BAYSENS110A	Dual Set Point w/ Manual/Auto Change Over	TTA073-TTA300 with ReliaTel™ Controls

**Table SC-5-B — Electromechanical Control Options**

Model Number	Description	Used With
ASYSTAT092A	2H/2C Touch Screen Digital Display Programmable Thermostat "Touch Screen"	All
ASYSTAT093A	3H/2C Digital Display Programmable Thermostat W/Humidity Sensor	All

① Kit comes with everything required for installation and operation.

## 6 - 25 Tons with ReliaTel™ Controls TTA073-120G, TTA120-240H, TTA120-300J

### Protection/Operation Timings and Features

**Anti Short Cycle Timer (ASCT) Function** — Provides a three (3) minute minimum “ON” time and a three (3) minute minimum “OFF” time for compressors, enhances compressor reliability by ensuring proper oil return. **Standard**

**Built In Fan Delay Relay (FDR) Function** — Provides custom indoor fan timing sequences for the different types of equipment, enhancing efficiency and reliability. **Standard**

**Built In Night Set Back and Unoccupied Functions**① — When using a standard dual setpoint/auto change over Zone Sensor Module (ZSM), this function is enabled by applying a short across terminal J6-11 and J6-12. Sets cooling setpoint up a minimum of 7°F, sets heating setpoint back a minimum of 7°F, and forces fan operation to automatic. **(requires time clock accessory or field supplied/installed switch or contacts).**

**Built In “TEST” Mode** — Aids in quick verification of system and control operation, exercises both hardware and software (no special tools required). **Standard**

**Built In Unoccupied Mode**① — When using a standard single setpoint/manual change over Zone Sensor Module (ZSM), this function is enabled by applying a short across terminal J6-11 and J6-12. Forces fan operation to automatic. **(requires time clock accessory or field supplied/installed switch or contacts.)**

**Direct Digital Control (DDC)**① — Proportional Integral (PI) control. Proportional – sets corrective action proportional to deviation from setpoint. Integral – fine tunes the rate of corrective action proportional to the error (results in superior space temperature control). **Standard**

**Increased Reliability** — Fewer components (moving electro-mechanical parts), less likelihood of equipment down time or failure. **Standard**

**Integral Electric Heat Staging**① — Stages electric heaters “OFF” and “ON”, eliminating the use of outdated sequencers. **Standard**

**Intelligent Fallback**① — A built in Default Control provides adaptive operation, which allows the equipment to continue to operate, providing comfort in the event of certain component failures. Also, allows emergency operation without a Zone Sensor Module (ZSM). **Standard**

**Low Ambient Start Timer (LAST) Function** — Bypasses low pressure control when a compressor starts, eliminating nuisance compressor lock outs. **Standard**

**Lower Installation Cost** — Using a standard Zone Sensor Module (ZSM), control voltage wiring may be run up to five (5) times further than any electromechanical system, with no increase in wire gauge. Example: Electromechanical System – 30 feet maximum using 22 gauge wire. Micro Control System – 150 feet using 22 gauge wire. **Standard**

**On Board Diagnostics**① — Assist with equipment troubleshooting, if a problem occurrence should take place. **Standard**

**Remote Sensing**① — All standard Zone Sensor Modules (ZSMs) have remote sensing capabilities, typically achieved by using an expensive program-mable thermostat and remote sensor with electromechanical equipment. **Accessory (requires use of remote sensor).**

**Space Temperature Averaging**① — All standard Zone Sensor Modules (ZSMs) have space temperature averaging capabilities, typically achieved by using an expensive programmable thermostat and minimum of four (4) remote sensors with electromechanical equipment. **Averaging with ReliaTel™ can be achieved with two (2) sensors.**

**Time Delay Relay (TDR) Function** — Provides an incremental staging delay between compressors, minimizes equipment current inrush and consumption by keeping compressors from starting simultaneously. **Standard**

**Low Pressure and High Pressure Compressor Lockout** — 3 trips will lockout control.

When the ReliaTel™ RTRM Thermostat Interface is used, equipment operation differs significantly. The basic equipment protection features remain intact, and the following features and benefits are lost:

- Direct Digital Control (DDC) – Proportional Integral (PI) control is lost, equipment is controlled by a thermostat or generic building automation system device.
- Intelligent Fall back is lost, if a failure occurs in the device controlling the equipment, operation will cease.
- Installation is more costly, with the addition of a thermostat or generic control, the control wiring size must be increased.
- Remote Sensing capabilities are lost, unless generic control being applied can accomplish this.
- Space Temperature Averaging capabilities are lost, unless generic control being applied can accomplish this.
- Built In Night Set Back and Unoccupied functions are lost, unless generic control being applied can accomplish this.
- Built In Unoccupied Mode is lost, unless generic control being applied can accomplish this.

① Denotes features lost from utilizing standard conventional stat.

# Split System Heat Pumps Three Phase – 6-20 Tons, R-410A

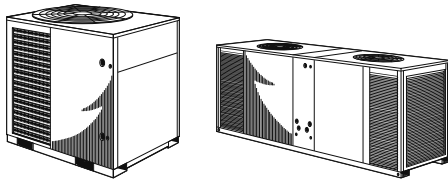

**TWA – 6-20 Tons**

- ReliaTel™ controls (standard)
- (1) Scroll compressor (TWA073-120D)
- (2) Scroll compressors (TWA180-240E) with independent refrigerant circuits
- Single point power
- Compressor motor overload protection
- Compressor discharge temperature limit switch
- Control transformer
- High and low pressure cut-out switches
- Liquid line filter drier, factory installed
- Service valves with pressure taps
- Demand Defrost Control
- Internal pressure relief valves
- Electrical phase reversal protection
- Holding charge (Dry Nitrogen)
- Copper tube, aluminum plate fin coils
- Low ambient cooling to 50°F as shipped
- Low ambient cooling to 0°F with accessory head pressure control
- Mounting/lifting rails under base
- UL listed
- **5-year compressor warranty (TWA073D, TWA090D, TWA120D, TWA180E, TWA240E)**
- **1-year limited parts warranty**
- **Optional Extended Warranties**

1 2 3 4 5 6 7 8 9 10 11 12  
T W A 0 9 0 D 3 0 0 A 0

**Compressor Type**

D = Single Compressor/Single Refrigerant Circuit, R-410A  
E = Dual Compressor/Dual Refrigerant Circuit, R-410A

**Factory-Installed Options**

OR = ReliaTel™ Controls  
OT = ReliaTel™ Controls and Black Epoxy Coated Coil

1 2 3 4 5 6 7 8 9 10 11 12  
T W A 0 9 0 D 3 0 0 A 0

**Compressor Type**

D = Single Compressor/Single Refrigerant Circuit, R-410A  
E = Dual Compressor/Dual Refrigerant Circuit, R-410A

**Factory-Installed Options**

HR = Hail Guard and ReliaTel™ Controls  
HT = Hail Guard and ReliaTel™ Controls with Black Epoxy Coated Coil

Light Commercial  
Split System Heat Pumps

**Table LSH-1-A — TWA Split System Heat Pumps — Single Compressors with Single Refrigerant Circuits — R-410 Refrigerant**

Model Number	Power Supply	Nom. Cap. Cooling (BTUH)	Uncrated Dimensions(in.)			Shipping Weight (lbs.)	Sound <sup>①</sup> Rating	MCA*	Max. Fuse*	Line Size (in)	
			H	W	L					OD Gas	OD Liq.
TWA073D30RA	208-230/3/60	78,000	39	36	42	382	84	31.1	40	1 <sup>1</sup> / <sub>8</sub>	1 <sup>1</sup> / <sub>2</sub>
TWA090D30RA	208-230/3/60	90,000	39	36	42	394	83	34.4	45	1 <sup>3</sup> / <sub>8</sub>	5 <sup>5</sup> / <sub>8</sub>
TWA120D30RA	208-230/3/60	120,000	45	40	52	509	90	42.6	60	1 <sup>3</sup> / <sub>8</sub>	1 <sup>1</sup> / <sub>2</sub>
TWA073D40RA	460/3/60	78,000	39	36	42	382	84	14.9	20	1 <sup>1</sup> / <sub>8</sub>	1 <sup>1</sup> / <sub>2</sub>
TWA090D40RA	460/3/60	90,000	39	36	42	394	83	17.9	25	1 <sup>3</sup> / <sub>8</sub>	5 <sup>5</sup> / <sub>8</sub>
TWA120D40RA	460/3/60	120,000	45	40	52	509	90	23.4	30	1 <sup>3</sup> / <sub>8</sub>	1 <sup>1</sup> / <sub>2</sub>
TWA073DW0RA	575/3/60	78,000	39	36	42	382	84	11.6	15	1 <sup>1</sup> / <sub>8</sub>	1 <sup>1</sup> / <sub>2</sub>
TWA090DW0RA	575/3/60	90,000	39	36	42	394	83	14.7	20	1 <sup>3</sup> / <sub>8</sub>	5 <sup>5</sup> / <sub>8</sub>
TWA120DW0RA	575/3/60	120,000	45	40	52	509	90	17.4	25	1 <sup>3</sup> / <sub>8</sub>	1 <sup>1</sup> / <sub>2</sub>

**Table LSH-1-B — TWA Split System Heat Pumps — Dual Compressors with Two Sets of Refrigerant Circuits — R-410 Refrigerant**

Model Number	Power Supply	Nom. Cap. Cooling (BTUH)	Uncrated Dimensions(in.)			Shipping Weight (lbs.)	Sound <sup>①</sup> Rating	MCA*	Max. Fuse*	Line Size (in)	
			H	W	L					OD Gas	OD Liq.
TWA180E30RA	208-230/3/60	180,000	46	45	95	898	93	66.3	80	1 <sup>3</sup> / <sub>8</sub>	1 <sup>1</sup> / <sub>2</sub>
TWA240E30RA	208-230/3/60	246,000	46	45	95	981	94	86.1	100	1 <sup>3</sup> / <sub>8</sub>	5 <sup>5</sup> / <sub>8</sub>
TWA180E40RA	460/3/60	180,000	46	45	95	898	93	33.4	40	1 <sup>3</sup> / <sub>8</sub>	1 <sup>1</sup> / <sub>2</sub>
TWA240E40RA	460/3/60	246,000	46	45	95	981	94	45.5	50	1 <sup>3</sup> / <sub>8</sub>	5 <sup>5</sup> / <sub>8</sub>
TWA180EW0RA	575/3/60	180,000	46	45	95	898	93	27.4	30	1 <sup>3</sup> / <sub>8</sub>	1 <sup>1</sup> / <sub>2</sub>
TWA240EW0RA	575/3/60	246,000	46	45	95	981	94	34.8	40	1 <sup>3</sup> / <sub>8</sub>	5 <sup>5</sup> / <sub>8</sub>

① Sound rating show is tested in accordance with AHRI Standard 270 or 370.

\* Information subject to change. Please confirm with current Product Data/Service Facts for current factory production.

# Split System Heat Pumps Three Phase – 7.5-20 Tons, R-22

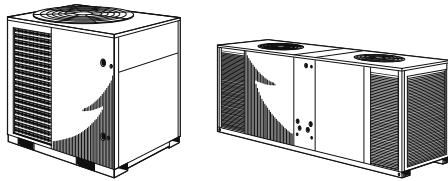

**TWA – 7.5-20 Tons**

- ReliaTel™ controls (standard)
- (1) Scroll compressor (TWA073-120A)
- (2) Scroll compressors (TWA180-240B) with independent refrigerant circuits
- Single point power
- Compressor motor overload protection
- Compressor discharge temperature limit switch
- Control transformer
- High and low pressure cut-out switches
- Liquid line filter drier, factory installed
- Service valves with pressure taps
- Demand Defrost Control
- Internal pressure relief valves
- Electrical phase reversal protection
- Holding charge (Dry Nitrogen)
- Copper tube, aluminum plate fin coils
- Low ambient cooling to 50°F as shipped
- Low ambient cooling to 0°F with accessory head pressure control
- Mounting/lifting rails under base
- UL listed

1 2 3 4 5 6 7 8 9 10 11 12  
T W A 0 9 0 A 3 0 0 A 0

**Compressor Type**

- A = Single Compressor/Single Refrigerant Circuit, R-22
- B = Dual Compressor/Dual Refrigerant Circuit, R-22

**Factory-Installed Options**

- OR = ReliaTel™ Controls

**Table LSH-2-A — TWA Split System Heat Pumps - Single Compressors with Single Refrigerant Circuits - R-22 Refrigerant**

Model Number	Power Supply	Nom. Cap. Cooling (BTUH)	Uncrated Dimensions(in.)			Shipping Weight (lbs.)	Sound <sup>Ⓢ</sup> Rating	MCA*	Max. Fuse*	Line Size (in)	
			H	W	L					OD Gas	OD Liq.
TWA090A30RG	208-230/3/60	90,000	39	36	42	394	83	31.1	45	1 <sup>3</sup> / <sub>8</sub>	5 <sup>5</sup> / <sub>8</sub>
TWA120A30RG	208-230/3/60	120,000	45	40	52	509	90	42.6	60	1 <sup>3</sup> / <sub>8</sub>	1 <sup>1</sup> / <sub>2</sub>
TWA090A40RG	460/3/60	90,000	39	36	42	394	83	15.2	25	1 <sup>3</sup> / <sub>8</sub>	5 <sup>5</sup> / <sub>8</sub>
TWA120A40RG	460/3/60	120,000	45	40	52	509	90	21.9	30	1 <sup>3</sup> / <sub>8</sub>	1 <sup>1</sup> / <sub>2</sub>

**Table LSH-2-B — TWA Split System Heat Pumps - Dual Compressors with Dual Refrigerant Circuits - R-22 Refrigerant**

Model Number	Power Supply	Nom. Cap. Cooling (BTUH)	Uncrated Dimensions(in.)			Shipping Weight (lbs.)	Sound <sup>Ⓢ</sup> Rating	MCA*	Max. Fuse*	Line Size (in)	
			H	W	L					OD Gas	OD Liq.
TWA180B30RG	208-230/3/60	180,000	46	45	95	898	93	60.4	80	1 <sup>3</sup> / <sub>8</sub>	5 <sup>5</sup> / <sub>8</sub>
TWA240B30RG	208-230/3/60	240,000	46	45	95	981	94	77.7	100	1 <sup>3</sup> / <sub>8</sub>	1 <sup>1</sup> / <sub>2</sub>
TWA180B40RG	460/3/60	180,000	46	45	95	898	93	29.5	40	1 <sup>3</sup> / <sub>8</sub>	5 <sup>5</sup> / <sub>8</sub>
TWA240B40RG	460/3/60	240,000	46	45	95	981	94	39.9	50	1 <sup>3</sup> / <sub>8</sub>	1 <sup>1</sup> / <sub>2</sub>

Ⓢ Sound rating show is tested in accordance with AHRI Standard 270 or 370.

\* Information subject to change. Please confirm with current Product Data/Service Facts for current factory production.

**Table LSH-3-A — R-410A Optional Accessories**

Model Number	Description	Used With
<b>Coil Guard</b>		
BAYGARD058A	Hail/Vandal Guard	TWA 073D,090D
BAYGARD060A	Hail/Vandal Guard	TWA120D
BAYGARD061A	Hail/Vandal Guard	TWA180E,240E
<b>Isolators</b>		
BAYISLT005A	Rubber Isolator Floor (black)	TWA073D-TWA120D
BAYISLT009A	Rubber Isolator Floor (red)	TWA180E
BAYISLT010A	Rubber Isolator Floor (green)	TWA240E
BAYISLT023A	Steel Spring Isolator Floor (red)	TWA073D, TWA090D, TWA120D
BAYISLT024A	Steel Spring Isolator Floor (black)	TWA180E
BAYISLT025A	Steel Spring Isolator Floor (yellow)	TWA240E
<b>Low Ambient</b>		
BAYLOAMU01A <sup>①②③</sup>	On/Off Fan Control Mounted in External Enclosure (small cabinets)	TWA073D-090D (all voltages)
BAYLOAMU02A <sup>②③</sup>	On/Off Fan Control Mounted in Unit Control Box (large cabinets)	TWA120D-240E (all voltages)
BAYLOAM335A <sup>③</sup>	Modulating ICM Head Pressure Control w/ 208-230V 0.5 HP Hi-Eff Motor (internal mount)	TWA073D, TWA090D3
BAYLOAM336A <sup>③</sup>	Modulating ICM Head Pressure Control w/ 208-230V 1 HP Hi-Eff Motor (internal mount)	TWA120D3
BAYLOAM435A <sup>③</sup>	Modulating ICM Head Pressure Control w/ 460V 0.5 HP Hi-Eff Motor (internal mount)	TWA073D4, TWA090D4
BAYLOAM436A <sup>③</sup>	Modulating ICM Head Pressure Control w/ 460V 1.0 HP Hi-Eff Motor (internal mount)	TWA120D4
BAYLOAMW36A <sup>③</sup>	Modulating ICM Head Pressure Control w/ 575V 1.0 HP Hi-Eff Motor (internal mount)	TWA120DW
<b>BACnet™ Communications Interface</b>		
BAYBCIR001A	BACnet (BCI-R) Communications Interface	All
<b>Time Delay Relay</b>		
BAYRLAY002	Time Delay Relay	TWA090D-TWA240E
BAYRLAY005	Heat Pump interlock relay	All TWA Units with BAYLOAM Application Requirements
<b>Wire Kit</b>		
BAYWRKT003A <sup>④</sup>	Heat Pump configuration wiring harness	TWA180E, TWA240E

① Kit mounts external to the outdoor unit and operates by sensing ambient and liquid line temperatures.

② Cycles fan on/off, (no modulating).

③ Quantity of 1 required for each fan (2 total for TTA/TWA180-240).

④ Used on Dual circuit HP condensers with a field installed LCI card for independent mechanical heating operation configuration.

# Split System Heat Pumps Three Phase – 6-20 Tons

**Table LSC-4-A — ReliaTel™ Control Options**

Model Number	Description	Used With
ASYSTAT107A	Zone Sensor, Set Point Adj, Fan, System, EH, LED	TWA073-TWA240 with ReliaTel™ Controls
ASYSTAT109A	Zone Sensor, 2 Set Point Adj, Fan, System, EH, LED	TWA073-TWA240 with ReliaTel™ Controls
ASYSTAT777A	Digital Programmable Zone Sensor with Night Setback	TWA073-TWA240, TTA073-TTA240 with ReliaTel™ Controls
BAYSENS050 <sup>①</sup>	Wireless Zone Sensor	TWA073-TWA240 with ReliaTel™ Controls
BAYSENS073A	Room Sensor w/ Override and Cancel Button	TWA073-TWA240 with ReliaTel™ Controls
BAYSENS074A	Room Sensor w/ Temperature Adjustment and Override Button	TWA073-TWA240 with ReliaTel™ Controls
BAYSENS077A	Remote Sensor	ASYSTAT107A, ASYSTAT109A, ASYSTAT777A
BAYSENS110A	Dual Set Point w/ Manual/Auto Change Over	TWA073-TWA240 with ReliaTel™ Controls

**Table LSC-4-B — Electromechanical Control Options**

Model Number	Description	Used With
ASYSTAT092A	2H/2C Touch Screen Digital Display Programmable Thermostat "Touch Screen"	All
ASYSTAT093A	3H/2C Digital Display Programmable Thermostat W/Humidity Sensor	All

<sup>①</sup> Kit comes with everything required for installation and operation.

# 6 - 20 Tons with ReliaTel™ Controls TWA073, TWA090, TWA120, TWA180, TWA240

## Protection/Operation Timings and Features

**Anti Short Cycle Timer (ASCT) Function** — Provides a three (3) minute minimum “ON” time and a three (3) minute minimum “OFF” time for compressors, enhances compressor reliability by ensuring proper oil return. **Standard**

**Built In Fan Delay Relay (FDR) Function** — Provides custom indoor fan timing sequences for the different types of equipment, enhancing efficiency and reliability. **Standard**

**Built In Night Set Back and Unoccupied Functions**① — When using a standard dual setpoint/auto change over Zone Sensor Module (ZSM), this function is enabled by applying a short across terminal J6-11 and J6-12. Sets cooling setpoint up a minimum of 7°F, sets heating setpoint back a minimum of 7°F, and forces fan operation to automatic. **(requires time clock accessory or field supplied/installed switch or contacts).**

**Built In “TEST” Mode** — Aids in quick verification of system and control operation, exercises both hardware and software (no special tools required). **Standard**

**Built In Unoccupied Mode**① — When using a standard single setpoint/manual change over Zone Sensor Module (ZSM), this function is enabled by applying a short across terminal J6-11 and J6-12. Forces fan operation to automatic. **(requires time clock accessory or field supplied/installed switch or contacts.)**

**Direct Digital Control (DDC)**① — Proportional Integral (PI) control. Proportional – sets corrective action proportional to deviation from setpoint. Integral – fine tunes the rate of corrective action proportional to the error (results in superior space temperature control). **Standard**

**Increased Reliability** — Fewer components (moving electro-mechanical parts), less likelihood of equipment down time or failure. **Standard**

**Integral Electric Heat Staging**① — Stages electric heaters “OFF” and “ON”, eliminating the use of outdated sequencers. **Standard**

**Intelligent Fallback**① — A built in Default Control provides adaptive operation, which allows the equipment to continue to operate, providing comfort in the event of certain component failures. Also, allows emergency operation without a Zone Sensor Module (ZSM). **Standard**

**Low Ambient Start Timer (LAST) Function** — Bypasses low pressure control when a compressor starts, eliminating nuisance compressor lock outs. **Standard**

**Lower Installation Cost** — Using a standard Zone Sensor Module (ZSM), control voltage wiring may be run up to five (5) times further than any electromechanical system, with no increase in wire gauge. Example: Electromechanical System – 30 feet maximum using 22 gauge wire. Micro Control System – 150 feet using 22 gauge wire. **Standard**

**On Board Diagnostics**① — Assist with equipment troubleshooting, if a problem occurrence should take place. **Standard**

**Remote Sensing**① — All standard Zone Sensor Modules (ZSMs) have remote sensing capabilities, typically achieved by using an expensive program-mable thermostat and remote sensor with electromechanical equipment. **Accessory (requires use of remote sensor).**

**Space Temperature Averaging**① — All standard Zone Sensor Modules (ZSMs) have space temperature averaging capabilities, typically achieved by using an expensive programmable thermostat and minimum of four (4) remote sensors with electromechanical equipment. **Averaging with ReliaTel™ can be achieved with two (2) sensors.**

**Time Delay Relay (TDR) Function** — Provides an incremental staging delay between compressors, minimizes equipment current inrush and consumption by keeping compressors from starting simultaneously. **Standard**

**Low Pressure and High Pressure Compressor Lockout** — 3 trips will lockout control.

When the ReliaTel™ RTRM Thermostat Interface is used, equipment operation differs significantly. The basic equipment protection features remain intact, and the following features and benefits are lost:

- Direct Digital Control (DDC) – Proportional Integral (PI) control is lost, equipment is controlled by a thermostat or generic building automation system device.
- Intelligent Fall back is lost, if a failure occurs in the device controlling the equipment, operation will cease.
- Installation is more costly, with the addition of a thermostat or generic control, the control wiring size must be increased.
- Remote Sensing capabilities are lost, unless generic control being applied can accomplish this.
- Space Temperature Averaging capabilities are lost, unless generic control being applied can accomplish this.
- Built In Night Set Back and Unoccupied functions are lost, unless generic control being applied can accomplish this.
- Built In Unoccupied Mode is lost, unless generic control being applied can accomplish this.

**Demand Defrost** — Defrosts only if needed, not based on time like most other systems, optimizing and lowering operating costs.

① Denotes features lost from utilizing standard conventional stat.



# Split System Air Handlers, R-410A

## Single Phase – 5-10 Tons

## Three Phase – 5-25 Tons

- Ships in horizontal configuration, but quickly and easily converts to upflow
- Expansion valve factory installed
- Check valves for heat pump applications
- Belt drive blower
- Factory installed motor, belt, sheaves, contactor, low voltage terminal board
- One inch filters on 5 to 10 ton units (rack convertible for field supplied two inch)
- Captive screws remain on the panels for service ease

- Low voltage terminal board
- Drain Pan
- Factory Installed (EDC) Evaporator Defrost Control
- IAQ (Indoor Air Quality) sloped/free draining pan, no standing water
- Two inch filters factory installed on 12½, 15, 20, 25 ton units
- Supplemental heaters (electric, water, steam) fits directly on unit discharge for low installation cost

- Single point power entry for reduced electrical power installation cost
- Unit fully assembled to reduce field installation costs
- Compact design with low service clearance to reduce building requirements
- Brazed refrigerant piping connections
- Fan relay UL listed and CSA Certified
- **Optional extended warranties**

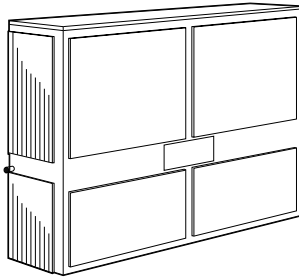

**5, 7½, 10, 12½, 15, 20, 25 Ton TWE Convertible Air Handlers (Upflow or Horizontal Only)**

1 2 3 456 7 8 9 10 11 12  
T W E 180 D 3 R 3 A A

**Capacity**

061 = 5 Tons      180 = 15 Tons  
090 = 7.5 Tons    240 = 20 Tons  
120 = 10 Tons    300 = 25 Tons  
150 = 12.5 Tons

**Factory-Installed Options**

- 00 = Standard Motor - Electromechanical Controls
- 03 = 2 speed VFD Standard Motor - Electromechanical Controls
- 04 = 2 speed VFD Oversized Motor - Electromechanical Controls
- R3 = SZVAV VFD Standard Motor - ReliaTel™ Controls
- R4 = SZVAV VFD Oversized Motor - ReliaTel™ Controls

**Table LAH-1-A — Single Circuit Coil - R-410A<sup>⑤</sup>**

Tons	Unit Model No.	Power Supply Volts/Phase/Hz	Capacity (Btuh)	FCCV	Drive Type	Dimensions (in.) <sup>④</sup> H x W x D	Shipping Weight (lbs.)	MCA*	Max Fuse Size or Max Circuit Breaker <sup>③</sup> *
<b>Single Phase</b>									
5	TWE061D100AA	208-230/1/60	60,000	TXV	Belt	48 x 39 x 23	263	7.5	15
7½	TWE090D100AA <sup>①</sup>	208-230/1/60	90,000	TXV	Belt	54 x 49 x 26	360	8.5	15
10	TWE120D100AA <sup>①</sup>	208-230/1/60	120,000	TXV	Belt	54 x 65 x 26	429	10.6	15
<b>Three Phase</b>									
5	TWE061D300AA	208-230/3/60	60,000	TXV	Belt	48 x 39 x 23	263	3.1	15
5	TWE061D400AA	460/3/60	60,000	TXV	Belt	48 x 39 x 23	263	1.6	15
5	TWE061DW00AA	575/3/60	60,000	TXV	Belt	48 x 39 x 23	263	1.6	15
7½	TWE090D300AA <sup>①②</sup>	208-230/3/60	90,000	TXV	Belt	54 x 49 x 26	360	6.6	15
7½	TWE090DW00AA <sup>①</sup>	575/3/60	90,000	TXV	Belt	54 x 49 x 26	360	2.3	15
10	TWE120D300AA <sup>①②</sup>	208-230/3/60	120,000	TXV	Belt	54 x 65 x 26	429	7.8	15
10	TWE120DW00AA <sup>①</sup>	575/3/60	120,000	TXV	Belt	54 x 65 x 26	429	2.9	15

<sup>①</sup> Control transformer not included. Order control transformer accessory when matching these air handlers with 3-5 ton condensing units.

<sup>②</sup> Ships wired for 208-230/3/60. Field convertible to 460/3/60.

<sup>③</sup> HACR type circuit breaker per NEC.

<sup>④</sup> Dimensions based on Upflow position.

<sup>⑤</sup> All air handlers are shipped with the drain pan installed in the horizontal position. For vertical configuration, the drain pan should be repositioned before setting the air handler.

\* Information subject to change. Please confirm with current Product Data/Service Facts for current factory production.

# Split System Air Handlers, R-410A

## Single Phase – 5-10 Tons

## Three Phase – 5-25 Tons

- Ships in horizontal configuration, but quickly and easily converts to upflow
- Expansion valve factory installed
- Check valves for heat pump applications
- Belt drive blower
- Factory installed motor, belt, sheaves, contactor, low voltage terminal board
- One inch filters on 5 to 10 ton units (rack convertible for field supplied two inch)
- Captive screws remain on the panels for service ease
- Low voltage terminal board
- Drain Pan

- Factory Installed (EDC) Evaporator Defrost Control
- IAQ (Indoor Air Quality) sloped/free draining pan, no standing water
- Two inch filters factory installed on 12½, 15, 20, 25 ton units
- Supplemental heaters (electric, water, steam) fits directly on unit discharge for low installation cost
- Single point power entry for reduced electrical power installation cost
- Unit fully assembled to reduce field installation costs

- Compact design with low service clearance to reduce building requirements
- Brazed refrigerant piping connections
- Fan relay UL listed and CSA Certified
- Factory installed 2 speed variable frequency drive (VFD) option available for enhanced part load performance and minimum REQUIRED for CA Title 24 Compliance®
- Factory installed Single Zone VAV (SZVAV) option available for enhanced part load performance and space temperature control via varying airflow®
- **Optional extended warranties**

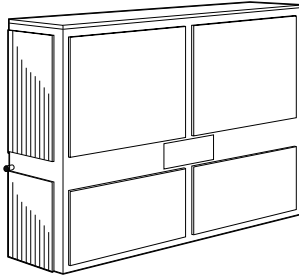

**5, 7½, 10, 12½, 15, 20, 25 Ton TWE Convertible Air Handlers (Upflow or Horizontal Only)**

1 2 3 456 7 8 9 10 11 12  
T W E 180 D 3 R 3 A A

**Capacity**

061 = 5 Tons      180 = 15 Tons  
090 = 7.5 Tons    240 = 20 Tons  
120 = 10 Tons    300 = 25 Tons  
150 = 12.5 Tons

**Factory-Installed Options**

00 = Standard Motor - Electromechanical Controls  
03 = 2 speed VFD Standard Motor - Electromechanical Controls  
04 = 2 speed VFD Oversized Motor - Electromechanical Controls  
R3 = SZVAV VFD Standard Motor - ReliaTel™ Controls  
R4 = SZVAV VFD Oversized Motor - ReliaTel™ Controls

**Table LAH-2-A — Dual Circuit Coil — R-410A**

Tons	Unit Model No.	Power Supply Volts/Phase/Hz	Capacity (Btuh)	FCCV	Drive Type	Dimensions (in.) <sup>④</sup> H x W x D	Shipping Weight (lbs.)	MCA <sup>*</sup>	Max Fuse Size or Max Circuit Breaker <sup>③*</sup>
<b>Single Phase</b>									
5	TWE061E100AA	208-230/1/60	60,000	TXV	Belt	48 x 39 x 23	263	7.5	15
7½	TWE090E100AA <sup>①</sup>	208-230/1/60	90,000	TXV	Belt	54 x 49 x 26	360	8.5	15
10	TWE120E100AA <sup>①</sup>	208-230/1/60	120,000	TXV	Belt	54 x 65 x 26	429	10.6	15
<b>Three Phase</b>									
5	TWE061E300AA	208-230/3/60	60,000	TXV	Belt	48 x 39 x 23	263	3.1	15
5	TWE061E400AA	460/3/60	60,000	TXV	Belt	48 x 39 x 23	263	1.6	15
7½	TWE090E300AA <sup>①②</sup>	208-230/3/60	90,000	TXV	Belt	54 x 49 x 26	360	6.6	15
10	TWE120E300AA <sup>①②</sup>	208-230/3/60	120,000	TXV	Belt	54 x 65 x 26	429	7.8	15
10	TWE120EW00AA <sup>①</sup>	575/3/60	120,000	TXV	Belt	54 x 65 x 26	429	2.9	15
12½	TWE150E300AA <sup>③</sup>	208-230/3/60	150,000	TXV	Belt	69 x 81 x 30	730	7.4	15
12½	TWE150EW00AA	575/3/60	150,000	TXV	Belt	69 x 81 x 30	730	2.8	15
15	TWE180E300AA <sup>③</sup>	208-230/3/60	180,000	TXV	Belt	69 x 81 x 30	729	11.8	20
15	TWE180EW00AA	575/3/60	180,000	TXV	Belt	69 x 81 x 30	729	4.3	15
20	TWE240E300BA	208-230/3/60	246,000	TXV	Belt	72 x 94 x 32	891	18.1	25
20	TWE240E400BA	460/3/60	246,000	TXV	Belt	72 x 94 x 32	891	8.4	15
20	TWE240EW00BA	575/3/60	246,000	TXV	Belt	72 x 94 x 32	891	6.5	15
25	TWE300E300A	208-230/3/60	292,000	TXV	Belt	72 x 94 x 32	972	24.5	30
25	TWE300E400A	460/3/60	292,000	TXV	Belt	72 x 94 x 32	972	11.2	20
25	TWE300EW00A	575/3/60	292,000	TXV	Belt	72 x 94 x 32	972	8.9	15

① Control transformer not included. Order control transformer accessory when matching these air handlers with 3-5 ton condensing units.

② Ships wired for 208-230/3/60. Field convertible to 460/3/60.

③ HACR type circuit breaker per NEC.

④ Dimensions based on Upflow position.

⑤ All air handlers are shipped with the drain pan installed in the horizontal position. For vertical configuration, the drain pan should be repositioned before setting the air handler.

⑥ 460V motors (digit 8=4) are only available on TWE150E and TWE180 when Title 24 or SZVAV is selected in digits 9 and 10.

\* Information subject to change. Please confirm with current Product Data/Service Facts for current factory production.

# Split System Air Handlers, R-410A

## Single Phase – 5-10 Tons

## Three Phase – 5-25 Tons

**Table LAH-3-A — 6 - 10 Ton Electric Heater Selection**

Model Number	Description	Used With
BAYHTRL106A	4.33/5.76 kW Heater 208/240/1 Phase	TWE061D1-TWE120E1
BAYHTRL112A	8.65/11.52 kW Heater 208/240/1 Phase	TWE061D1-TWE120E1
BAYHTRL117A	12.98/17.28 kW Heater 208/240/1 Phase	TWE061D1-TWE120E1
BAYHTRL123A	17.30/23.04 kW Heater 208/240/1 Phase	TWE061D1-TWE120E1
BAYHTRL129A	21.65/28.80 kW Heater 208/240/1 Phase	TWE061D1-TWE120E1
BAYHTRL305A	3.75/5.00 kW Heater 208/240/3 Phase	TWE061D3-TWE120E3
BAYHTRL310A	7.45/9.96 kW Heater 208/240/3 Phase	TWE061D3-TWE120E3
BAYHTRL315A	11.25/14.96 kW Heater 208/240/3 Phase	TWE061D3-TWE120E3
BAYHTRL325A	18.71/24.92 kW Heater 208/240/3 Phase	TWE061D3-TWE120E3
BAYHTRL335A	26.20/34.88 kW Heater 208/240/3 Phase	TWE061D3-TWE120E3
BAYHTRL405A	5.00 kW Heater 460/3 Phase	TWE061D4-TWE120E3①
BAYHTRL410A	9.96 kW Heater 460/3 Phase	TWE061D4-TWE120E3①
BAYHTRL415A	14.96 kW Heater 460/3 Phase	TWE061D4-TWE120E3①
BAYHTRL425A	24.92 kW Heater 460/3 Phase	TWE061D4-TWE120E3①
BAYHTRL435A	34.88 kW Heater 460/3 Phase	TWE061D4-TWE120E3①
BAYHTRLW05A	5 kW Heater 575/3 Phase	TWE061DW-TWE120EW
BAYHTRLW10A	9.96 kW Heater 575/3 Phase	TWE061DW-TWE120EW
BAYHTRLW15A	14.96 kW Heater 575/3 Phase	TWE061DW-TWE120EW
BAYHTRLW25A	24.92 kW Heater 575/3 Phase	TWE061DW-TWE120EW
BAYHTRLW35A	34.88 kW Heater 575/3 Phase	TWE061DW-TWE120EW

**Table LAH-3-B — 12½ - 20 Ton Electric Heater Selection**

Model Number	Description	Used With
BAYHTRM310A	7.50/10.0 kW Heater 208/230 3 Phase	TWE150E3-TWE300E3
BAYHTRM320A	14.96/19.92 kW Heater 208/230 3 Phase	TWE150E3-TWE300E3
BAYHTRM330A	22.50/29.92 kW Heater 208/230 3 Phase	TWE150E3-TWE300E3
BAYHTRM350A	37.42/49.84 kW Heater 208/230 3 Phase	TWE150E3-TWE300E3
BAYHTRM410A	10.0 kW Heater 460/3 Phase	TWE150E3①-TWE300E4
BAYHTRM420A	19.92 kW Heater 460/3 Phase	TWE150E3①-TWE300E4
BAYHTRM430A	29.92 kW Heater 460/3 Phase	TWE150E3①-TWE300E4
BAYHTRM450A	49.84 kW Heater 460/3 Phase	TWE150EW-TWE300EW
BAYHTRMW10A	10.0 kW Heater 575/3 Phase	TWE150EW-TWE300EW
BAYHTRMW20A	19.92 kW Heater 575/3 Phase	TWE150EW-TWE300EW
BAYHTRMW30A	29.92 kW Heater 575/3 Phase	TWE150EW-TWE300EW
BAYHTRMW50A	49.84 kW Heater 575/3 Phase	TWE150EW-TWE300EW

① Field convertible to 460/3/60.

# Split System Air Handlers, R-410A

## Single Phase – 5-10 Tons

## Three Phase – 5-25 Tons

**Table LAH-4-A — 5 – 20 Ton Accessory Selection**

Model Number	Description	Used With
<b>Subbase</b>		
BAYBASE009A	Vertical Air Handler Subbase	TWE061D, TWE061E
BAYBASE010A	Vertical Air Handler Subbase	TWE090D, TWE090E
BAYBASE011A	Vertical Air Handler Subbase	TWE120D, TWE120E
BAYBASE012A	Vertical Air Handler Subbase	TWE150E, TWE180E
BAYBASE013A	Vertical Air Handler Subbase	TWE240E, TWE300E
<b>Grille</b>		
BAYGRLE001A	Return Air Grille	TWE061D/E
BAYGRLE002A	Return Air Grille	TWE090D/E
BAYGRLE003A	Return Air Grille	TWE120D/E
BAYGRLE004A	Return Air Grille	TWE150E, TWE180E
BAYGRLE005A	Return Air Grille	TWE240E, TWE300E
<b>High Static Motor</b>		
BAYHSMT104A	1.5HP (230/1) w/ 1VL44 motor sheave w/ AK54 fan sheave w/ A44 belt	TWE061D1/E1
BAYHSMT105A	1.5HP (230-460/3) w/ 1VL44 motor sheave w/ AK54 fan sheave w/ A44 belt	TWE061D3-4/E3-4
BAYHSMT106A	1.5HP (575/3) w/ 1VL44 motor sheave w/ AK54 fan sheave w/ A44 belt	TWE061DW/EW
BAYHSMT107A	2 HP (230/1) w/ 1VL44 motor sheave w/ AK66 fan sheave w/ A50 belt	TWE090D1/E1
BAYHSMT108A	2 HP (230/460/3) w/ 1VL44 motor sheave w/ AK66 fan sheave w/ A50 belt	TWE090D3/E3
BAYHSMT109A	2 HP (575/3) w/ 1VL44 motor sheave w/ AK66 fan sheave w/ A50 belt	TWE090DW/EW
BAYHSMT110A	3 HP (230/460/3) w/ 1VP44 motor sheave w/ AK54 fan sheave w/ AX48 belt	TWE090D3/E3
BAYHSMT111A	3 HP (575/3) w/ 1VP44 motor sheave w/ AK54 fan sheave w/ AX48 belt	TWE090DW/EW
BAYHSMT112A	3 HP (230/460/3) w/ 1VP44L motor sheave w/ AK74 fan sheave w/ A51 belt	TWE120D3/E3
BAYHSMT113A	3 HP (575/3) w/ 1VP44L motor sheave w/ AK74 fan sheave w/ A51 belt	TWE120DW/EW
BAYHSMT114A	3 HP (230/460/3) w/ 1VP44L motor sheave w/ BK72 fan sheave w/ A51 belt	TWE150E3
BAYHSMT115A	3 HP (575/3) w/ 1VP44L motor sheave w/ BK72 fan sheave w/ A51 belt	TWE150EW
BAYHSMT116A	5 HP (230/3) w/ 1VP50L motor sheave w/ BK72 fan sheave w/ BX55 belt	TWE150E3
BAYHSMT117A	5 HP (460/3) w/ 1VP50L motor sheave w/ BK72 fan sheave w/ BX55 belt	TWE150E4
BAYHSMT118A	5 HP (575/3) w/ 1VP50L motor sheave w/ BK72 fan sheave w/ BX55 belt	TWE150EW
BAYHSMT119A	5 HP (230/3) w/ 1VP50L motor sheave w/ BK85 fan sheave w/ BX58 belt	TWE180E3
BAYHSMT120A	5 HP (460/3) w/ 1VP50L motor sheave w/ BK85 fan sheave w/ BX58 belt	TWE180E4
BAYHSMT121A	5 HP (575/3) w/ 1VP50L motor sheave w/ BK85 fan sheave w/ BX58 belt	TWE180EW
BAYHSMT122A	7.5 HP (230/460/3) w/ 1VP60 motor sheave w/ BK90 fan sheave w/ BX60 belt	TWE240E3/4
BAYHSMT123A	7.5 HP (575/3) w/ 1VP60 motor sheave w/ BK90 fan sheave w/ BX60 belt	TWE240EW
<b>Isolators</b>		
BAYISLT004A①②③④	Rubber Isolator Floor (blue)	TWE061D-TWE120E
BAYISLT009A①②③	Rubber Isolator Floor (red)	TWE150E, TWE180E
BAYISLT010A①②③	Rubber Isolator Floor (green)	TWE240E, TWE300E
BAYISLT012B③	Rubber Isolator Suspended (red/green)	TWE150E, TWE180E
BAYISLT013B③④	Rubber Suspended (red/green)	TWE061D/E
BAYISLT014A③④	Rubber Suspended (green)	TWE090D/E
BAYISLT015B③④	Rubber Suspended (green/black)	TWE120D/E
BAYISLT016B③	Rubber Suspended (red/green)	TWE240E, TWE300E
BAYISLT019A①②③	Steel Spring Isolator Floor (red)	TWE061D/E, TWE090D/E, TWE120D/E
BAYISLT021A①②③	Steel Spring Isolator Floor (black)	TWE150E, TWE180E
BAYISLT032A①②③	Steel Spring Isolator Floor (black/yellow)	TWE240E
BAYISLT028A③	Steel Spring Isolator Suspended (tan)	TWE061D/E
BAYISLT029A③	Steel Spring Isolator Suspended (red)	TWE090D/E, TWE120D/E
BAYISLT030A③	Steel Spring Isolator Suspended (black)	TWE150E, TWE180E
BAYISLT031B③	Steel Spring Isolator Suspended (black/yellow)	TWE240E, TWE300E
<b>Low Static Drive Kit</b>		
BAYLSMT001A	Low Static Drive Kit	TWE240E

① When the Air handler is in the vertical position and close proximity trapping of condensate is required, use of subbase is required.

② Requires use of subbase accessory.

③ Units having steam of hot water coils applied vertically or horizontally check IOM for proper Isolator kit selection.

④ Do not use if blower will operate less than 600 RPM.

# Split System Air Handlers, R-410A

## Single Phase – 5-10 Tons

## Three Phase – 5-25 Tons

**Table LAH-5-A — 5 – 20 Ton Accessory Selection**

Model Number	Description	Used With
<b>Plenum</b>		
BAYPLNM015B <sup>②</sup>	Discharge Plenum & Grille	TWE061D/E
BAYPLNM016B <sup>②</sup>	Discharge Plenum & Grille	TWE090D/E
BAYPLNM017B <sup>②</sup>	Discharge Plenum & Grille	TWE120D/E
BAYPLNM018B <sup>②</sup>	Discharge Plenum/Hydronic Coil Plenum & Grille	TWE150E, TWE180E
BAYPLNM019B <sup>②</sup>	Discharge Plenum/Hydronic Coil Plenum & Grille	TWE240E, TWE300E
BAYPLNM020B <sup>②</sup>	Hydronic Coil Discharge Plenum & Grille	TWE061D/E
BAYPLNM021B <sup>②</sup>	Hydronic Coil Discharge Plenum & Grille	TWE090D/E
BAYPLNM022B <sup>②</sup>	Hydronic Coil Discharge Plenum & Grille	TWE120D/E
BAYPLNM030A <sup>②</sup>	Electric Heat Discharge Plenum & Grille	TWE061D/E
BAYPLNM031A <sup>②</sup>	Electric Heat Discharge Plenum & Grille	TWE090D/E
BAYPLNM032A <sup>②</sup>	Electric Heat Discharge Plenum & Grille	TWE120D/E
BAYPLNM033A <sup>②</sup>	Electric Heat Discharge Plenum & Grille	TWE150E, TWE180E
BAYPLNM034A <sup>②</sup>	Electric Heat Discharge Plenum & Grille	TWE240E, TWE300E
<b>Transformer</b>		
BAYTFMR011A <sup>①</sup>	75va transformer (230V)	TWE090D3, TWE090E3, TWE120D3, TWE120E3
BAYTFMR012A <sup>①</sup>	75va transformer	TWE090D4/W, TWE090E4/W, TWE120D4/W, TWE120E4/W
BAYTFMR013A <sup>①</sup>		TWE090DK, TWE090EK, TWE120DK, TWE120EK
<b>Water Kits</b>		
BAYWATR022A <sup>②</sup>	Steam Coil Enclosure	TWE061D/E
BAYWATR023A <sup>②</sup>		TWE090D/E
BAYWATR024A <sup>②</sup>		TWE120D/E
BAYWATR025A <sup>②</sup>		TWE150E, TWE180E
BAYWATR026A <sup>②</sup>		TWE240E, TWE300E
BAYWATR027A <sup>②</sup>	Hot Water Coil Enclosure	TWE061D/E
BAYWATR028A <sup>②</sup>		TWE090D/E
BAYWATR029A <sup>②</sup>		TWE120D/E
BAYWATR030A <sup>②</sup>		TWE150E, TWE180E
BAYWATR031A <sup>②</sup>		TWE240E, TWE300E
<b>Wire Kit</b>		
BAYWRKT002A <sup>③</sup>	180 Blower Discharge Reversal Kit	TWE061D-TWE120E

① Required when 6 -10 Ton Air Handlers are matched with 3-5 Ton condensing units.

② When installed horizontally, plenum/water coil must be self supported.

③ Cannot be used on TWE150-240, due to motor mount location.

# Split System Air Handlers 5-25 Tons

## Factory Supplied Accessories

- (A) Air Handler (TWE 5 – 20 Tons)
- (B) Outdoor Condensing Unit (TTA – Cooling 6 – 25 Tons)  
(TWA – Heat Pump 6 – 20 Tons)
- (P) Discharge Plenum and Grille (BAYPLNM)
- (EH) Electric Heater and Casing (BAYHTRL)  
Fits on Top of Unit (13 H x 30 W x 17 D)
- (SB) Subbase (BAYBASE)
- (I) Isolators (BAYISLT)
- (RG) Return Grille (BAYGRLE)
- (CG) Coil Guards (BAYLOAM)
- (WC) Steam/Hot Water Coil (BAYWATR)

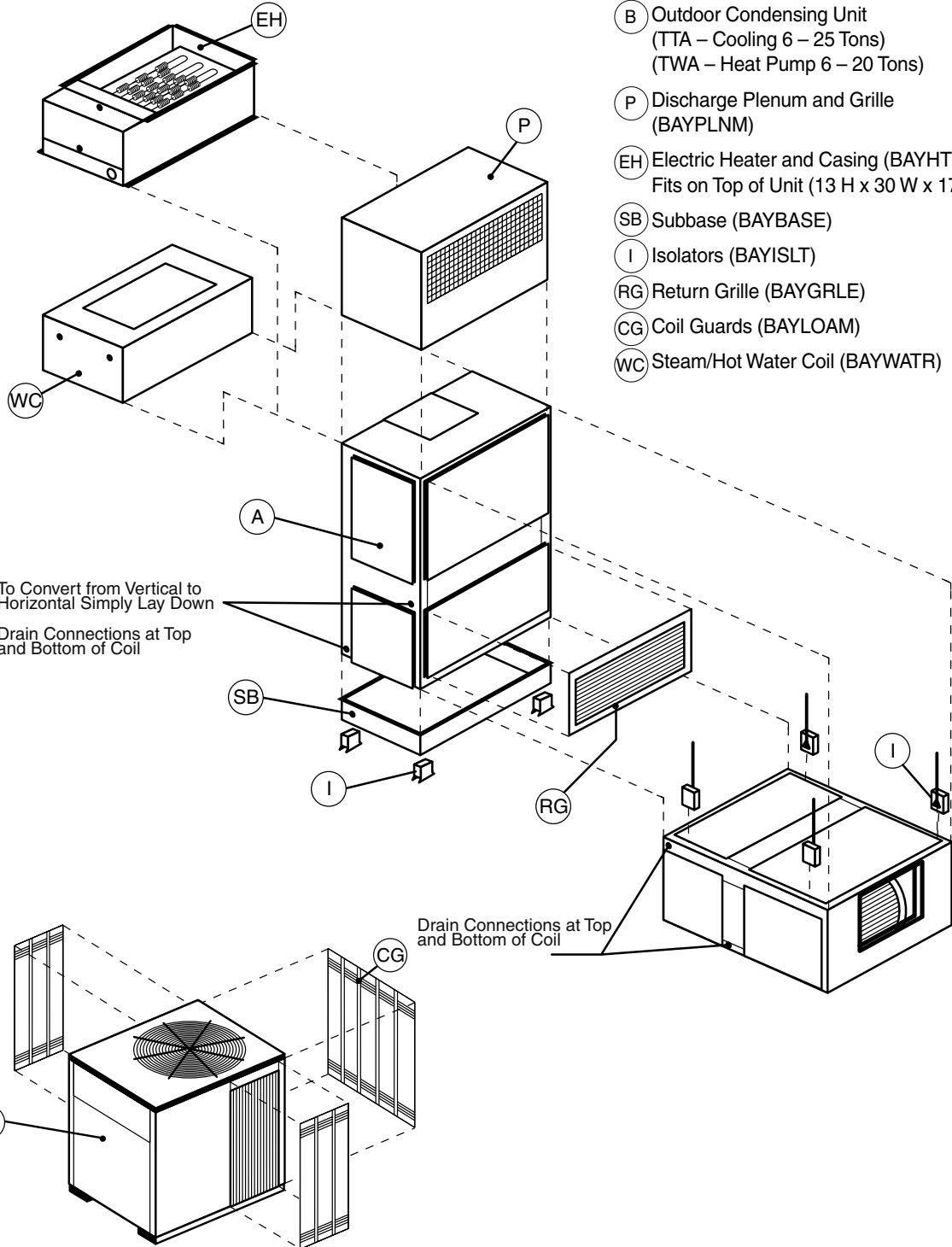

Light Commercial  
Air Handlers/Heaters

## Non-Programmable Comfort Controls for ReliaTel™ Units



**ASYSSTAT095A**

### ASYSSTAT095A

- One-touch temperature control.
- Large, clear, backlit display is easy to read, even in the dark.
- Displays both room temperature and temperature setting.
- Removable battery holder for fast, easy replacement.
- Built-in compressor protection.
- **Focus Pro 3 Heat/ 2 Cool**

## Programmable Comfort Controls for ReliaTel™ Units



**ASYSSTAT090A**

### ASYSSTAT090A

- Large, Clear Display with Backlighting — Current temperature, set temperature and time are easy-to-read and all are displayed on the main screen.
- Menu Driven Programming — Provides guidance through the scheduling process, showing only necessary information and choices on each screen.
- Ability to Select Multiple Days — Allows easy customizing for unique schedules.
- Real-Time Clock—Keeps time during power failure; automatically updates for daylight saving time.
- Armchair Programming — Can remove thermostat from wall to set the schedule.
- Precise Temperature Control ( $\pm 1$  °F) — reliable, consistent comfort.
- Multiple OVERRIDE options — Can modify schedule for a specific period of time (up to 365 days).
- Outdoor Temperature Indication — Displays current outdoor temperature to help plan outdoor activities.
- **2 Heat/2 Cool**

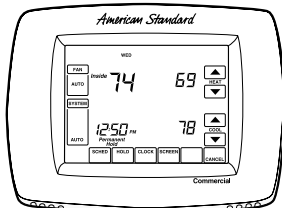

**ASYSSTAT092A**

### ASYSSTAT092A

- Large, Clear Display with Backlighting — Current temperature, set temperature and time are easy-to-read and all are displayed on the main screen.
- Menu Driven Programming — Provides guidance through the scheduling process, showing only necessary information and choices on each screen.
- Ability to Select Multiple Days — Allows easy customizing for unique schedules.
- Real-Time Clock — Keeps time during power failure; automatically updates for daylight savings.
- Armchair Programming — Can remove thermostat from wall to set the schedule. Precise Temperature Control ( $\pm 1$  °F) — reliable, consistent comfort.
- Multiple OVERRIDE options — Can modify schedule indefinitely or for a specific period of time.
- Programmable Fan — Increases indoor air quality when combined with air cleaning equipment.
- Outdoor Temperature Indication — Displays current outdoor temperature to help plan outdoor activities.
- **2 Heat/2 Cool Commercial Vision Pro**

## Programmable Comfort Controls for ReliaTel™ Units

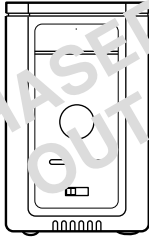

**ASYSTAT800A**

### ASYSTAT800A

- Wall mounted remote space sensor
- For use with ASYSTAT090A, ASYSTAT092A, and ASYSTAT093A programmable thermostats



# Zone Sensor Unit Installation

---

The zone sensor provides the operator control and zone temperature sensing functions for use with electronic unit controls. Refer to the appropriate unit installation manual for interconnecting wiring instructions.

## ZONE SENSOR LOCATION

To ensure proper operation, select a location on an interior wall, at a height approximately 5 feet above the floor, with freely circulating air of average temperature.

### Avoid Locations:

- Behind doors or in corners where air does not freely circulate.
- On an outside wall or any wall with unheated (uncooled) areas behind the zone sensor.
- Where direct sunlight or any Source: of radiant heat could affect the temperature measurements.
- In line with the discharge air from the unit being controlled.

Mount the zone sensor base on the wall or optional mounting plate with the wires routed through the wire access hole in the base of the zone sensor.

## ZONE SENSOR CONTROLS

### Emergency Heat/Heat/Auto/Off/Cool

This switch determines whether the unit operates in emergency heat (EM. HEAT - for heat pumps only), heating (HEAT), automatically changing from heating to cooling as required (AUTO), heating and cooling functions disabled (OFF), or cooling (COOL).

### Fan Auto/Fan On

This switch determines whether the indoor fan operates during cooling and heating cycles only (FAN AUTO) or runs continuously (FAN ON).

### Temperature Adjustments

One or two temperature adjustment controls are provided to set the desired temperature or temperature range (for unit mode AUTO). If two controls are present, the blue control sets the desired temperature for cooling and the red control sets the desired temperature for heating.

### Temperature Indicator

This indicates the temperature in the zone. The indicator has been factory calibrated and should not normally require adjustment. If adjustment is needed, it can be accomplished by slowly rotating a small screwdriver in the slot on the back of the indicator until the correct temperature is obtained.

### Optional Remote Sensor

When using the optional remote sensor (BAYSENS077A), it should be located in the space that is to be controlled. Wire according to the interconnecting wiring diagrams in the unit IOM.

Installation: 18-HD60D41

Source: Clarksville

# Micro Control Zone Sensors



**ASYSSTAT106A**  
**Manual Changeover**

- 4 wires required.
- Single Setpoint for 3-25 Tons Electric/Electric and Gas/Electric Systems
- Can be used with Remote Sensor (ASYSSTAT669)



**ASYSSTAT107A**  
**Manual Changeover**

- 4-6 wires required.
- Single Setpoint for W- Heat Pump Systems (3-20 Tons)
- Can be used with Remote Sensor (ASYSSTAT669)



**ASYSSTAT108A**  
**Automatic Changeover**

- 5 wires required.
- Dual Setpoint for Electric/Electric and Gas Electric Systems (3-25 Tons)
- Can be used with Remote Sensor (ASYSSTAT669)



**ASYSSTAT109A**  
**Automatic Changeover**

- 5-7 wires required.
- Dual Setpoint for W- Heat Pump Systems (3-20 Tons)
- Can be used with Remote Sensor (ASYSSTAT669)



**ASYSSTAT709A/707A**  
**LCD Digital Display Zone Sensor**

- 3-7 wires required.
- Non-Programmable Zone Sensor with a digital display
- ASYSSTAT709A - Cool/Gas
- ASYSSTAT707A - Heat Pumps

Zone Sensors must be used with Micro Control units. Vendor Thermostats which use Triac outputs are not recommended with Micro Control units. Major features lost by using a Conventional Thermostat include the following:

- No diagnostics
- Proportional Integral control
- No smart recovery in the heating mode (heat pumps)
- 2-stage electric heat (heat pumps)
- Stand alone set up and set back for unoccupied features
- Intelligent fall back (unit can run on default value with outdoor air sensor)
- Control wiring size may be increased
- Remote sensing capability
- Space temperature averaging
- Supply air tempering
- Economizer preferred cooling is lost (compressor operation is locked out below 50°F)

For complete equipment / combination selections, installation instructions and warranty information, please refer to Product Data/Ratings and/or Installers Guides and Limited Warranty Handbooks.

## Electronic Programmable Zone Sensors For ReliaTel™ Units

---



### ASYSSTAT777A

- **Automatic or Manual Changeover with System Lights**
- Use With:
  - 3 – 10 Ton Precedent™ Units
  - 12.5 – 25 Ton Voyager™ Units
- Digital display indicating the time of day, the day of the week, room temperature, current program operating mode, and current active stage
- Continuous or 3 hour timed override
- Two occupied, two unoccupied programs per day
- L.C.D. readout in F or C (Celsius) and 12 or 24-hour clock
- Keyboard disable to prevent tampering
- Programming on a 7-day basis
- Status indication lights displayed in Digital Display
- Auxiliary relay (Form 1C)
- Auto Fan During Setback
- No Anticipator Required
- No Battery Required
- No accessories required. Each unit is complete and ready for installation
- Remote Room Sensor (ASYSSTAT669)
- Finish: Pantone Cool Gray #2C
- Replacement: SEN-0415
- Installation: 18-HD60D29
- Source: Clarksville

## Integrated Comfort™ Systems Sensors For ReliaTel™ Units

---



### ASYSSTAT669

- **Room Sensor**
- Used with Integrated Comfort™ Systems
- Used With:
  - 3 - 10 Ton Precedent™ Units
  - 12.5 - 25 Ton Voyager™ Units
- Finish: Pantone Cool Gray #2C
- Replacement: SEN01448
- Installation: Included with sensor
- Source: St. Paul GCC/Clarksville

## Packaged Cooling Convertible 3-10 Tons



Beveled Top  
Smoother Design  
Small compact cabinet  
Recessed access handles

### Standard Features:

- American Standard Heating & Air Conditioning scroll compressors on all 3-10 ton units
- Colored and numbered wiring
- Phase Monitor, R-410A 3 Phase Units
- Provisions for through the Base Condensate Drain Connections
- 2" throwaway filters provided on all ton units
- Liquid Line Refrigerant Drier
- Operating Charge of R-410A
- IAQ Sloped Drain Pans
- Single point power for Electric Heat
- Low Ambient to 40°F on Electromechanical models
- Low Ambient to 0°F on ReliaTel™ models
- 5 - year Limited Compressor Warranty
- 1 - year Limited Parts Warranty

### Added Flexibility

- Electromechanical or ReliaTel™ controls (**See page LPC-14 for ReliaTel™ Control Information**)
- Standard or high efficiency cooling models available. 17+ available in 3T to 5T. For reference to 17+ please refer to publications RT-PRC048-EN and RT-SLB020-EN
- Convertible airflow (ships in downflow application)
- Fork lift openings on three sides of unit
- Direct or belt drive - standard or oversized motors (Direct for 3-5 ton only)
- We don't prepackage options
- Choose options tailored to suit each job —pay only for what is needed
- Units ship with options installed —and within our standard ship cycle time

### Factory Installed Options

- Through-the-Base — Electrical
- Convenience Outlet — Powered or unpowered
- Unit Disconnect Switch
- Smoke Detectors — Supply, return, or both
- Condenser Coil Coating
- Hinged Access Service Panels
- Discharge Air Sensor
- Fan Fail and Clogged Filter Switches
- Condenser Coil Guard — Hail Protection Quality
- Dehumidification Hot Gas Reheat Coil
- Froststat
- Novar Controls
- Comm 3/4 Communications Interface
- 2" Pleated Media filters
- 2" MERV 8 filters or 2" MERV 13 filters
- Multi-Speed & Single Zone VAV ID Airflow
- Demand Control Ventilation
- Stainless Steel Drainpan
- Condensate Drainpan Overflow Switch

**The same American Standard Heating & Air Conditioning Quality and Reliability ... with added Flexibility!**

# Packaged Cooling Convertible 3-5 Tons, R-410A

**Table LPC-2-A — 17 Plus — R-410A — ReliaTel™ Controls Only**

Tons	Unit Ordering No.	Performance SEER	Cooling Capacity (Btuh)	Cabinet Dimensions (in.) H x W x L	Downflow Supply	Downflow Return	Shipping Weight (lbs.)	MCA**	Max Fuse**
<b>THC - 208-230/3/60 - Three Phase - No Heat</b>									
3	THC037E3R0A0000	17.5	36,500	36 x 44 x 69	16 x 15.5	24 x 14	614	23.3	30
4	THC047E3R0A0000	17.5	50,500	41 x 53 x 88	33 x 17.5	32 x 17.5	787	29.4	40
5	THC067E3R0A0000	17.2	60,000	41 x 53 x 88	33 x 17.5	32 x 17.5	841	32.2	45
<b>THC - 460/3/60 - Three Phase - No Heat</b>									
3	THC037E4R0A0000	17.5	36,500	36 x 44 x 69	16 x 15.5	24 x 14	614	11.4	15
4	THC047E4R0A0000	17.5	50,500	41 x 53 x 88	33 x 17.5	32 x 17.5	787	13.7	20
5	THC067E4R0A0000	17.2	60,000	41 x 53 x 88	33 x 17.5	32 x 17.5	841	15.2	20

**Table PC-2-B — Base Unit — 15 SEER High Efficiency — R-410A — Electromechanical or ReliaTel™**

Tons	Unit Ordering No.	Performance <sup>②</sup> SEER	Cooling Capacity (Btuh)	Cabinet Dimensions (in.) H x W x L	Downflow Supply	Downflow Return	Shipping Weight (lbs.)	MCA**	Max <sup>①</sup> Fuse**
<b>THC - 208-230/1/60 - Single Phase - No Heat</b>									
3	THC036E1*0A0000	15.2	38,490	36 x 44 x 69	16 x 15.5	24 x 14	555	26.7	40
4	THC048E1*0A0000	15.0	48,930	41 x 53 x 88	33 x 17.5	32 x 17.5	798	35.7	50
5	THC060E1*0A0000	15.0	62,480	41 x 53 x 88	33 x 17.5	32 x 17.5	823	43.8	70
<b>THC - 208/3/60 - Three Phase - No Heat</b>									
3	THC036E3*0A0000	15.0	38,490	36 x 44 x 69	16 x 15.5	24 x 14	555	21.9	30
4	THC048E3*0A0000	15.0	48,930	41 x 53 x 88	33 x 17.5	32 x 17.5	637	28.3	40
5	THC060E3*0A0000	15.0	62,480	41 x 53 x 88	33 x 17.5	32 x 17.5	869	32.1	45
<b>THC - 460/3/60 - Three Phase - No Heat</b>									
3	THC036E4*0A0000	15.0	38,490	36 x 44 x 69	16 x 15.5	24 x 14	555	10.2	15
4	THC048E4*0A0000	15.0	48,930	41 x 53 x 88	33 x 17.5	32 x 17.5	637	13.8	20
5	THC060E4*0A0000	15.0	62,480	41 x 53 x 88	33 x 17.5	32 x 17.5	869	17.0	25

**Table LPC-2-C — Base Unit — 14 SEER — R-410A — Electromechanical or ReliaTel™**

Tons	Unit Ordering No.	Performance SEER	Cooling Capacity (Btuh)	Cabinet Dimensions (in.) H x W x L	Downflow Supply	Downflow Return	Shipping Weight (lbs.)	MCA**	Max Fuse**
<b>TSC - 208-230/3/60 - Three Phase - No Heat</b>									
3	TSC036G3*0A0000	14.0	38,490	36 x 44 x 69	16 x 15.5	24 x 14	555	21.9	30
4	TSC048G3*0A0000	14.0	48,930	41 x 53 x 88	33 x 17.5	32 x 17.5	637	28.3	40
5	TSC060G3*0A0000	14.0	62,480	41 x 53 x 88	33 x 17.5	32 x 17.5	869	32.1	45
<b>TSC - 460/3/60 - Three Phase - No Heat</b>									
3	TSC036G4*0A0000	14.0	38,490	36 x 44 x 69	16 x 15.5	24 x 14	555	10.2	15
4	TSC048G4*0A0000	14.0	48,930	41 x 53 x 88	33 x 17.5	32 x 17.5	637	13.8	20
5	TSC060G4*0A0000	14.0	62,480	41 x 53 x 88	33 x 17.5	32 x 17.5	869	17.0	25

**Table LPC-2-D — Base Unit — 13 SEER — R-410A — Electromechanical or ReliaTel™**

Tons	Unit Ordering No.	Performance SEER	Cooling Capacity (Btuh)	Cabinet Dimensions (in.) H x W x L	Downflow Supply	Downflow Return	Shipping Weight (lbs.)	MCA**	Max Fuse**
<b>TSC - 208-230/3/60 - Three Phase - No Heat</b>									
3	TSC033G3*0A0000	13.0	38,490	36 x 44 x 69	16 x 15.5	24 x 14	555	21.9	30
4	TSC043G3*0A0000	13.0	48,930	41 x 53 x 88	33 x 17.5	32 x 17.5	637	28.3	40
5	TSC063G3*0A0000	13.0	62,480	41 x 53 x 88	33 x 17.5	32 x 17.5	869	32.1	45
<b>TSC - 460/3/60 - Three Phase - No Heat</b>									
3	TSC033G4*0A0000	13.0	38,490	36 x 44 x 69	16 x 15.5	24 x 14	555	10.2	15
4	TSC043G4*0A0000	13.0	48,930	41 x 53 x 88	33 x 17.5	32 x 17.5	637	13.8	20
5	TSC063G4*0A0000	13.0	62,480	41 x 53 x 88	33 x 17.5	32 x 17.5	869	17.0	25

① HACR breaker per NEC.

② SEER applies, 3-5 tons; EER applies 6-10 tons.

\* Digit 9 - E = Electromechanical or R = ReliaTel™.

\*\* Information subject to change. Please confirm with current Product Data/Service Facts for current factory production.

# Packaged Cooling Convertible 3-5 Tons, R-410A

**Table LPC-3-A — Base Unit — 13 SEER — R-410A — Electromechanical or ReliaTel™**

Tons	Unit Ordering No.	Performance SEER	Cooling Capacity (Btuh)	Cabinet Dimensions (in.) H x W x L	Downflow Supply	Downflow Return	Shipping Weight (lbs.)	MCA**	Max Fuse**
<b>TSC - 208-230/3/60 - Three Phase - No Heat</b>									
3	TSC036E3*0A0000	13.0	37,150	36 x 44 x 69	16 x 15.5	24 x 14	555	23.0	35
4	TSC048E3*0A0000	13.0	49,450	36 x 44 x 69	16 x 15.5	24 x 14	586	25.2	35
5	TSC060E3*0A0000	13.0	62,270	36 x 44 x 69	16 x 15.5	24 x 14	636	29.5	45
<b>TSC - 460/3/60 - Three Phase - No Heat</b>									
3	TSC036E4*0A0000	13.0	37,150	36 x 44 x 69	16 x 15.5	24 x 14	555	11.7	15
4	TSC048E4*0A0000	13.0	49,450	36 x 44 x 69	16 x 15.5	24 x 14	586	12.5	15
5	TSC060E4*0A0000	13.0	62,270	36 x 44 x 69	16 x 15.5	24 x 14	636	15.5	25
<b>TSC - 575/3/60 - Three Phase - No Heat</b>									
3	TSC036EW*0A0000	13.0	37,150	36 x 44 x 69	16 x 15.5	24 x 14	555	9.4	15
4	TSC048EW*0A0000	13.0	49,450	36 x 44 x 69	16 x 15.5	24 x 14	586	9.0	15
5	TSC060EW*0A0000	13.0	62,270	36 x 44 x 69	16 x 15.5	24 x 14	636	10.1	15

① HACR breaker per NEC.

② SEER applies, 3-5 tons; EER applies 6-10 tons.

\* Digit 9 - E = Electromechanical or R = ReliaTel™.

\*\* Information subject to change. Please confirm with current Product Data/Service Facts for current factory production.

# Packaged Cooling Convertible 6 - 10 Tons, R-410A

**Table LPC-4-A — Base Unit — High Efficiency — R-410A — Electromechanical or ReliaTel™**

Tons	Unit Ordering No.	Performance EER	Cooling Capacity (Btuh)	Cabinet Dimensions (in.) H x W x L	Downflow Supply	Downflow Return	Shipping Weight (lbs.)	MCA**	Max <sup>①</sup> Fuse**
<b>THC – 208-230/3/60 – Three Phase High Efficiency</b>									
6	THC072F3*0A0000	12.6	72,000	47 x 53 x 88	33 x 17.5	32 x 17.5	997	33.9	50
6	THC074F3*0A0000	13.1	73,000	47 x 53 x 88	33 x 17.5	32 x 17.5	1016	37.4	50
7½	THC092F3*0A0000	12.6	92,000	47 x 53 x 88	33 x 17.5	32 x 17.5	1026	41.9	50
8½	THC102F3*0A0000	12.5	103,000	47 x 53 x 88	33 x 17.5	32 x 17.5	1026	42.0	50
10	THC120E3*0A0000	12.5	119,000	51 x 63 x 100	33 x 17.5	32 x 17.5	1563	50.3	60
<b>THC – 460/3/60 – Three Phase</b>									
6	THC072F4*0A0000	12.6	72,000	47 x 53 x 88	33 x 17.5	32 x 17.5	997	16.3	25
6	THC074F4*0A0000	13.1	73,000	47 x 53 x 88	33 x 17.5	32 x 17.5	1016	18.7	25
7½	THC092F4*0A0000	12.6	92,000	47 x 53 x 88	33 x 17.5	32 x 17.5	1026	19.9	25
8½	THC102F4*0A0000	12.5	103,000	47 x 53 x 88	33 x 17.5	32 x 17.5	1026	19.9	25
10	THC120E4*0A0000	12.5	119,000	51 x 63 x 100	33 x 17.5	32 x 17.5	1563	24.9	30

**Table LPC-4-B — Base Unit — Standard Efficiency — R-410A — Electromechanical or ReliaTel™**

Tons	Unit Ordering No.	Performance SEER/EER	Cooling Capacity (Btuh)	Cabinet Dimensions (in.) H x W x L	Downflow Supply	Downflow Return	Shipping Weight (lbs.)	MCA**	Max Fuse**
<b>TSC – 208-230/3/60 – Three Phase – No Heat</b>									
6	TSC072F3*0A0000	11.2	75,000	42 x 53 x 88	33 x 17.5	32.13 x 17.5	898	36.5	50
7½	TSC090F3*0A0000	11.2	89,000	42 x 53 x 88	33 x 17.5	32.13 x 17.5	815	38.2	60
7½	TSC092F3*0A0000	11.2	94,000	46 x 53 x 88	33 x 17.5	32.13 x 17.5	1009	41.2	50
8½	TSC102F3*0A0000	11.2	102,000	46 x 53 x 88	33 x 17.5	32.13 x 17.5	1048	46.3	60
10	TSC120F3*0A0000	11.3	119,000	46 x 53 x 88	33 x 17.5	32.13 x 17.5	1058	49.6	60
<b>TSC – 460/3/60 – Three Phase – No Heat</b>									
6	TSC072F4*0A0000	11.2	75,000	42 x 53 x 88	33 x 17.5	32.13 x 17.5	898	18.2	25
7½	TSC090F4*0A0000	11.2	89,000	42 x 53 x 88	33 x 17.5	32.13 x 17.5	815	19.5	30
7½	TSC092F4*0A0000	11.2	94,000	46 x 53 x 88	33 x 17.5	32.13 x 17.5	1009	21.5	25
8½	TSC102F4*0A0000	11.2	102,000	46 x 53 x 88	33 x 17.5	32.13 x 17.5	1048	21.9	25
10	TSC120F4*0A0000	11.3	119,000	46 x 53 x 88	33 x 17.5	32.13 x 17.5	1058	22.7	35
<b>TSC – 575/3/60 – Three Phase – No Heat</b>									
6	TSC072FW*0A0000	11.2	75,000	42 x 53 x 88	33 x 17.5	32.13 x 17.5	898	12.7	20
7½	TSC090FW*0A0000	11.2	89,000	42 x 53 x 88	33 x 17.5	32.13 x 17.5	815	14.7	20
7½	TSC092FW*0A0000	11.2	94,000	46 x 53 x 88	33 x 17.5	32.13 x 17.5	1009	15.0	20
8½	TSC102FW*0A0000	11.2	102,000	46 x 53 x 88	33 x 17.5	32.13 x 17.5	1048	17.5	20
10	TSC120FW*0A0000	11.3	119,000	46 x 53 x 88	33 x 17.5	32.13 x 17.5	1058	18.9	25

① HACR breaker per NEC.

\* Digit 9-E=Electromechanical or R=ReliaTel™.

\*\* Information subject to change. Please confirm with current Product Data/Service Facts for current factory production.

# Packaged Cooling Convertible 3-10 Tons (Model Digit Numbers)

Digit	Description	Order Number	Digit	Description	Order Number
1-8	<b>Main Assembly (see previous page)</b>		21	<b>Communications Options</b> <sup>⑫</sup>	
9	<b>Unit Controls</b>			No Communications Interface .....	0
	Electro-Mechanical .....	E		Comm 3/4 Communications Interface .....	1
	ReliaTel™ Micro-processor .....	R		Novar 2024 Controls .....	3
10	<b>(See Heater Table below)</b>			Novar 3051 Controls .....	4
11	<b>Minor Design Sequence</b>			Novar 3051 Controls Interface with DCV .....	5
	First Sequence .....	A		BACnet™ Communications Interface .....	6
12-13	<b>Service Sequence</b>		22	<b>Refrigeration System Option</b>	
	First Sequence (Factory Supplied) .....	* *		Standard Refrigeration System .....	0
14	<b>Fresh Air Selection</b>			Dehumidification (Hot Gas Reheat Coil) <sup>⑯</sup> .....	B
	No Fresh Air .....	0	23	<b>Refrigeration Controls</b>	
	0-50% Manual Outside Air Damper <sup>⑩</sup> .....	A		<b>Note: Applicable to Digit 7 = E, F</b>	
	0-50% Motorized Outside Air Damper .....	B		No Refrigeration Control .....	0
	0-100% Economizer, Dry Bulb without			Froststat <sup>④</sup> .....	1
	Barometric Relief <sup>②</sup> .....	C		Crankcase Heater .....	2
	0-100% Economizer, Dry Bulb with			Froststat and Crankcase Heater .....	3
	Barometric Relief <sup>②</sup> .....	D	24	<b>Smoke Detector</b> <sup>⑤ ⑫</sup>	
	0-100% Economizer, Reference Enthalpy			No Smoke Detector .....	0
	without Barometric Relief <sup>① ②</sup> .....	E		Return Air Smoke Detector <sup>⑥ ⑦</sup> .....	A
	0-100% Economizer, Reference Enthalpy			Supply Air Smoke Detector .....	B
	with Barometric Relief <sup>① ②</sup> .....	F		Supply and Return Air Smoke Detectors <sup>⑥ ⑦</sup> .....	C
	0-100% Economizer, Comparative Enthalpy			Plenum Smoke Detector .....	D
	without Barometric Relief <sup>① ②</sup> .....	G	25	<b>Monitoring Controls</b> <sup>⑫</sup>	
	0-100% Economizer, Comparative Enthalpy			No Monitoring Control <sup>⑧</sup> .....	0
	with Barometric Relief <sup>① ②</sup> .....	H		Clogged Filter Switch <sup>⑧</sup> .....	1
	Low Leak Economizer, Dry Bulb			Fan Failure Switch <sup>⑧</sup> .....	2
	with Barometric Relief .....	K		Discharge Air Sensing Tube <sup>⑧</sup> .....	3
	Low Leak Economizer, Comparative Enthalpy			Clogged Filter Switch and Fan Fail Switch <sup>⑧</sup> .....	4
	with Barometric Relief .....	M		Clogged Filter Switch and Discharge	
	Low Leak Economizer, Reference Enthalpy			Air Sensing Tube <sup>⑧</sup> .....	5
	with Barometric Relief .....	P		Fan Fail Switch and Discharge Air Sensing Tube <sup>⑧</sup> .....	6
15	<b>Supply Fan/Drive Type/Motor</b>			Clogged Filter and Fan Fail Switches	
	Standard Drive .....	0		and Discharge Air Sensing Tube <sup>⑧</sup> .....	7
	Oversized Motor .....	1		Novar Return Air Sensor <sup>⑨</sup> .....	8
	Optional Belt Drive Motor (3 phase only) .....	2		Novar 3051 Zone Sensor <sup>⑩</sup> .....	9
	Single Zone VAV .....	6		Condensate Drain Pan Overflow Switch .....	A
	Multi-Speed Indoor Fan .....	7		Clogged Filter Switch <sup>⑩</sup> and	
	VAV Supply Air Temperature Control Standard Motor ..	E		Condensate Drain Pan Overflow Switch .....	B
16	<b>Hinged Service Access &amp; Filters</b>			Fan Failure Switch <sup>⑩</sup> and Condensate	
	Standard Panels & Filters .....	0		Drain Pan Overflow Switch .....	C
	Hinged Access Panels & Standard Filters .....	A		Discharge Air Sensing <sup>⑩</sup> and	
	Standard Panels & 2" Pleated Filters MERV 8 .....	B		Condensate Drain Pan Overflow Switch .....	D
	Hinged Access Panels & 2" Pleated Filters MERV 8 .....	C		Clogged Filter Switch <sup>⑩</sup> , Fan Failure Switch <sup>⑩</sup>	
	Standard Panels/2" MERV 13 Filters .....	D		and Condensate Drain Pan Overflow Switch .....	E
	Hinged Access Panels/2" MERV 13 Filters .....	E		Clogged Filter Switch <sup>⑩</sup> , Discharge Air	
17	<b>Condenser Coil Protection</b>			Sensing Tube <sup>⑩</sup> and Condensate Drain	
	Standard Coil .....	0		Overflow Switch .....	F
	Standard Coil with Hail Guard .....	1		Fan Failure Switch, Discharge Air Sensing Tube <sup>⑩</sup>	
	Black Epoxy Pre-Coated Condenser Coil .....	2		and Condensate Drain Pan Overflow Switch .....	G
	Black Epoxy Pre-Coated Condenser Coil			Clogged Filter Switch <sup>⑩</sup> , Fan Failure Switch <sup>⑩</sup> ,	
	with Hail Guard .....	3		Discharge Air Sensing <sup>⑩</sup> and Condensate Drain	
	Complete Coat™ Condenser Coil .....	4		Pan Overflow Switch .....	H
	Complete Coat™ Condenser Coil with Hail Guard .....	5	26	<b>System Monitoring Controls</b>	
18	<b>Through the Base Provisions</b>			No Monitoring Controls .....	0
	No Through the Base Provisions .....	0		Demand Control Ventilation (CO <sub>2</sub> ) <sup>⑭ ⑮</sup> .....	A
	Through the Base Electric <sup>⑩</sup> .....	A	27	<b>Unit Hardware Enhancements</b>	
19	<b>Disconnect/Circuit Breaker /Phase Monitor (3 phase only)</b>			No Enhancements .....	0
	No Disconnect/ Circuit Breaker .....	0		Stainless Steel Drain Pan .....	1
	Unit Mounted Non-Fused Disconnect <sup>⑩</sup> .....	1		Fault Detection and Diagnostics (FDD) .....	B
	Unit Mounted Circuit Breaker <sup>⑩</sup> .....	2		Fault Detection and Diagnostics (FDD)	
20	<b>Convenience Outlet</b>			with Demand Control Ventilation .....	C
	No Convenience Outlet .....	0	31	<b>Advanced Unit Controls</b>	
	Unpowered Convenience Outlet .....	A		Standard Unit Controls .....	0
	Powered Convenience Outlet (3 phase only) <sup>⑩</sup> .....	B		Human Interface .....	1

① Enthalpy control not available factory installed with electro-mechanical controls.  
 ② Economizer with Barometric Relief is for downflow configured units only. Order Economizer without Barometric Relief for horizontal configuration. Barometric relief for horizontal configured units must be ordered as field installed accessory BAYBARM010A.  
 ③ Requires use of Disconnect or Circuit Breaker.  
 ④ Froststat cannot be field installed in electro-mechanical units.  
 ⑤ Not available with BAYFRST001A High Temperature Stat accessory.  
 ⑥ The return air smoke detector may not fit up or work properly on the Convertible units when used in conjunction with 3rd party accessories such as bolt on heat wheels, economizers and power exhaust. Do not order the return air smoke detectors when using this type of accessory.  
 ⑦ Return Air Smoke Detector cannot be ordered with Novar Controls.  
 ⑧ These options are standard when ordering Novar Controls.  
 ⑨ This options for use when ordering Novar Control only.  
 ⑩ The manual outside air damper will ship factory supplied within the unit, but must be field installed.  
 ⑪ Through the base electric required when ordering disconnect/circuit breaker options.  
 ⑫ Not available with electro-mechanical unit controls.  
 ⑬ Novar Sensor utilized with digit 21 = (4) Novar 3051 Controls without Zone Sensor.  
 ⑭ Available for T/Y 10 ton standard efficiency models only.  
 ⑮ Available for T/Y 3, 4, 5, 6, 7½, 8½ ton standard/high efficiency models only.  
 ⑯ Requires selection of 2" Pleated Filters (option B or C) for Digit 16.  
 ⑰ Not available on 6 ton units and all single phase or standard efficiency.  
 ⑱ Standard on T/YSC 6, 7½ (single and dual systems), 8½, 10 ton standard efficiency models and T/YHC 4, 5, 6, 7½ ton high efficiency models (except for dehumidification models).  
 ⑲ Epoxy coil and epoxy with hailguard options are not available for units with microchannel condenser coil.  
 ⑳ Single Zone VAV is only available on 7.5-10 ton high efficiency and 10 ton standard efficiency products with ReliaTel™ controls.  
 ㉑ Multi-speed indoor fan available only on 7.5 & 8.5 ton high efficiency, and 10 ton products with ReliaTel™ controls.  
 ㉒ Motorized Outside Air Damper is not available on Multi-Speed or SZVAV (Single Zone Variable Air Volume) products.  
 ㉓ Froststat standard on Multi-Speed and SZVAV (Single Zone Variable Air Volume) products.  
 ㉔ Novar is not available with SZVAV products.  
 ㉕ Demand Control Ventilation not available with electromechanical controls.  
 ㉖ Demand Control Ventilation Option includes wiring only. The CO<sub>2</sub> sensor is a field-installed only option.  
 ㉗ When ordering Dehumidification option, Digit #7 will revert back to E, not F.



# Packaged Cooling Convertible 3-10 Tons (Model Digit Numbers)

## Heaters (Digit 10)

kW Rating	Digit	Nominal BTUH	No. Stages	Used With	kW Rating	Digit	Nominal BTUH	No. Stages	Used With
<b>208/240/1/60</b>					<b>460/3/60</b>				
3.7/5.0	(A)	12,800/17,100	1	T*C036-060*1	6.0	(B)	20,500	1	T*C036-060*4
7.5/10.0	(D)	25,600/34,100	2	T*C036-060*1	12.0	(E)	41,000	2	T*C036-060*4
10.3/13.8	(F)	35,300/47,100	2	T*C036-060*1	17.6	(G)	59,400	2	T*C036-060*4
13.2/17.6	(G)	45,100/60,100	2	T*C048-060*1	23.0	(J)	78,500	2	T*C060*4
<b>208/240/3/60</b>					<b>575/3/60</b>				
4.5/6.0	(B)	13,400/20,500	1	T*C036-060*3	9.0	(C)	30,700	1	T*C072-102,*4
9.0/12.0	(E)	30,800/59,400	2	T*C036-060*3	18.0	(G)	61,400	1	T*C072-120*4
13.2/17.6	(G)	44,600/59,400	2	T*C036-060*3	27.0	(K)	92,100	2	T*C072-120*4
17.2/23.0	(J)	58,900/78,500	2	T*C060*3	36.0	(N)	122,900	2	T*C072-120*4
6.75/9.0	(C)	23,000/30,700	1	T*C072-102*3	54.0	(P)	184,300	2	T*C120*4
13.5/18.0	(G)	46,100/61,400	1	T*C072-120*3	6.0	(B)	20,500	1	T*C036-060*W
20.3/27.0	(K)	69,000/92,100	2	T*C072-120*3	12.0	(E)	41,000	2	T*C036-060*W
27.0/36.0	(N)	92,200/122,900	2	T*C072-120*3	17.6	(G)	59,400	2	T*C036-060*W
40.5/54.0	(P)	138,200/184,300	2	T*C120*3	23.0	(J)	78,500	2	T*C060*W
					9.0	(C)	30,700	1	T*C072-102*W
					18.0	(G)	61,400	1	T*C072-120*W
					27.0	(K)	92,100	2	T*C072-120*W
					36.0	(N)	122,900	2	T*C072-120*W
					54.0	(P)	184,300	2	T*C120*W

# Packaged Cooling Convertible 3-10 Tons, R-410A Electric Heaters

**Table LPC-7-A — Accessory Electric Heaters – Unit with heater is single circuit / single point power entry**

Model Number	Power Supply	kW Rating	Nominal BTUH	No. Stages	Used With
BAYHTRE105A	208-230/1/60	3.8/5.0	12,900/13,400	1	T*C036E1, TSC048-060E1
BAYHTRE110A	208-230/1/60	7.5/10.0	25,600/34,000	2	T*C036E1, TSC048-060E1
BAYHTRE114A	208-230/1/60	10.4/13.8	35,000/47,100	2	T*C036E1, TSC048-060E1
BAYHTRE118A	208-230/1/60	13.2/17.6	45,100/60,100	2	TSC048-060E1
BAYHTRE306B	208-230/3/60	4.5/6.0	13,400/20,500	1	T*C036E3, TSC048-060E3, THC037E3
BAYHTRE312B	208-230/3/60	9.0/12.0	30,800/41,000	2	T*C036E3, TSC048-060E3, THC037E3
BAYHTRE318B	208-230/3/60	13.0/17.4	44,600/59,400	2	T*C036E3, TSC048-060E3, THC037E3
BAYHTRE323B	208-230/3/60	17.3/23.0	44,600/59,400	2	TSC060E3
BAYHTRE406B	460/3/60	6.0	20,500	1	T*C036E4, TSC048-060E4, THC037E4
BAYHTRE412B	460/3/60	12.0	41,000	2	T*C036E4, TSC048-060E4, THC037E4
BAYHTRE418B	460/3/60	17.4	59,400	2	T*C036E4, TSC048-060E4, THC037E4
BAYHTRE423B	460/3/60	17.3/23.0	59,400	2	TSC060E4
BAYHTREW06B	575/3/60	6.0	20,500	1	T*C036EW, TSC048-060EW
BAYHTREW12B	575/3/60	12.0	41,000	2	T*C036EW, TSC048-060EW
BAYHTREW18B	575/3/60	17.4	59,400	2	T*C036EW, TSC048-060EW
BAYHTREW23B	575/3/60	17.3/23.0	59,400	2	TSC060EW
BAYHTRX105A	208-230/1/60	3.8/5.0	12,900/13,400	1	THC048-060F1
BAYHTRX110A	208-230/1/60	7.5/10.0	25,600/34,000	2	THC048-060F1
BAYHTRX114A	208-230/1/60	10.4/13.8	35,000/47,100	2	THC048-060F1
BAYHTRX118A	208-230/1/60	13.2/17.6	45,100/60,100	2	THC048-060F1
BAYHTRX306B	208-230/1/60	4.5/6.0	13,400/20,500	1	THC048-060F3, THC047E3, THC067E3
BAYHTRX312B	208-230/3/60	9.0/12.0	30,800/41,000	2	THC048-060F3, THC047E3, THC067E3
BAYHTRX318B	208-230/3/60	13.0/17.4	44,600/59,400	2	THC048-060F3, THC047E3, THC067E3
BAYHTRX323B	208-230/3/60	17.3/23.0	59,000/78,500	2	THC060F3
BAYHTRX406B	460/3/60	6.0	20,500	1	THC048-060F4, THC047E4, THC067E4
BAYHTRX412B	460/3/60	12.0	41,000	2	THC048-060F4, THC047E4, THC067E4
BAYHTRX418B	460/3/60	18.0	59,400	2	THC048-060F4, THC047E4, THC067E4
BAYHTRX423B	460/3/60	23.0	78,500	2	THC060F4, THC067E4

# Packaged Cooling Convertible 6-10 Tons, R-410A Electric Heaters

**Table LPC-8-A — Accessory Electric Heaters – Unit with heater is single circuit / single point power entry**

Model Number	Power Supply	kW Rating	Nominal BTUH	No. Stages	Used With
BAYHTRS309B	208-230/3/60	6.75/9.0	23,000/30,700	1	TSC072F3
BAYHTRS318B	208-230/3/60	13.5/18.0	46,100/61,400	2	TSC072F3
BAYHTRS327B	208-230/3/60	20.3/27.0	69,000/92,100	2	TSC072F3
BAYHTRS336B	208-230/3/60	27.0/36.0	92,200/122,900	2	TSC072F3
BAYHTRW309A	208-230/3/60	6.75/9.0	23,000/30,700	1	TSC090F3
BAYHTRW318A	208-230/3/60	13.5/18.0	46,100/61,400	1	TSC090F3
BAYHTRW327A	208-230/3/60	20.3/27.0	69,000/92,100	2	TSC090F3
BAYHTRW336A	208-230/3/60	27.0/36.0	92,200/122,900	2	TSC090F3
BAYHTRT309B	208-230/3/60	6.75/9.0	23,000/30,700	1	TSC092F3, TSC102F3
BAYHTRT318B	208-230/3/60	13.5/18.0	46,100/61,400	2	TSC092F3, TSC102F3
BAYHTRT327B	208-230/3/60	20.3/27.0	69,000/92,100	2	TSC092F3, TSC102F3
BAYHTRT336B	208-230/3/60	27.0/36.0	92,200/122,900	2	TSC092F3, TSC102F3
BAYHTRA318A	208-230/3/60	13.5/18	46,100/61,400	1	TSC120F3
BAYHTRA327A	208-230/3/60	20.3/27	69,000/92,100	2	TSC120F3
BAYHTRA336A	208-230/3/60	27/36	92,200/122,900	2	TSC120F3
BAYHTRA354A	208-230/3/60	40.5/54	138,200/184,300	2	TSC120F3
BAYHTRS409B	460/3/60	9.0	30,700	1	TSC072F4
BAYHTRS418B	460/3/60	18.0	61,400	2	TSC072F4
BAYHTRS427B	460/3/60	27.0	92,100	2	TSC072F4
BAYHTRS436B	460/3/60	36.0	122,900	2	TSC072F4
BAYHTRW409A	460/3/60	9	30,700	1	TSC090F4
BAYHTRW418A	460/3/60	18	61,400	1	TSC090F4
BAYHTRW427A	460/3/60	27	92,100	2	TSC090F4
BAYHTRW436A	460/3/60	36	122,900	2	TSC090F4
BAYHTRT409B	460/3/60	9.0	30,700	1	TSC092F4, TSC102F4
BAYHTRT418B	460/3/60	18.0	61,400	2	TSC092F4, TSC102F4
BAYHTRT427B	460/3/60	27.0	92,100	2	TSC092F4, TSC102F4
BAYHTRT436B	460/3/60	36.0	122,900	2	TSC092F4, TSC102F4
BAYHTRA418A	460/3/60	18	61,400	1	TSC120F4**B
BAYHTRA427A	460/3/60	27	92,100	2	TSC120F4**B
BAYHTRA436A	460/3/60	36	122,900	2	TSC120F4**B
BAYHTRA454A	460/3/60	54	184,300	2	TSC120F4**B

## Packaged Cooling Convertible 6-10 Tons, R-410A Electric Heaters

**Table LPC-9-A — Accessory Electric Heaters – Unit with heater is single circuit / single point power entry**

Model Number	Power Supply	kW Rating	Nominal BTUH	No. Stages	Used With
BAYHTRSW09B	575/3/60	9.0	30,700	1	TSC072FW
BAYHTRSW18B	575/3/60	18.0	61,400	2	TSC072FW
BAYHTRSW27B	575/3/60	27.0	92,100	2	TSC072FW
BAYHTRSW36B	575/3/60	36.0	122,900	2	TSC072FW
BAYHTRWW18A	575/3/60	18	61,400	1	TSC090FW
BAYHTRWW27A	575/3/60	27	92,100	2	TSC090FW
BAYHTRWW36A	575/3/60	36	122,900	2	TSC090FW
BAYHTRTW18B	575/3/60	18.0	61,400	2	TSC092FW, TSC102FW
BAYHTRTW27B	575/3/60	27.0	92,100	2	TSC092FW, TSC102FW
BAYHTRTW36B	575/3/60	36.0	122,900	2	TSC092FW, TSC102FW
BAYHTRAW18A	575/3/60	18	61,400	1	TSC120FW
BAYHTRAW36A	575/3/60	36	122,900	2	TSC120FW
BAYHTRAW54A	575/3/60	54	184,300	2	TSC120FW
BAYHTRU309A	208-230/3/60	6.8/9.0	23,000/30,700	1	THC072F3
BAYHTRU318A	208-230/3/60	13.5/18.0	46,100/61,400	1	THC072F3
BAYHTRU327A	208-230/3/60	20.3/27.0	69,000/92,100	2	THC072F3
BAYHTRU336A	208-230/3/60	27.0/36.0	92,100/122,900	2	THC072F3



HEATING & AIR CONDITIONING

# Packaged Cooling Convertible 6-10 Tons, High Efficiency R-410A Electric Heaters

**Table LPC-10-A — Accessory Electric Heaters – Unit with heater is single circuit / single point power entry**

Model Number	Power Supply	kW Rating	Nominal BTUH	No. Stages	Used With
BAYHTRA309A	208-230/3/60	9.0	30,700	1	THC092F3, THC102F3
BAYHTRA318A	208-230/3/60	18.0	61,400	1	THC092F3, THC102F3
BAYHTRA327A	208-230/3/60	27.0	92,100	2	THC092F3, THC102F3
BAYHTRA336A	208-230/3/60	36.0	122,900	2	THC092F3, THC102F3
BAYHTRA409A	460/3/60	9.0	30,700	1	THC092F4, THC102F4
BAYHTRA418A	460/3/60	18.0	61,400	1	THC092F4, THC102F4
BAYHTRA427A	460/3/60	27.0	92,100	2	THC092F4, THC102F4
BAYHTRA436A	460/3/60	36.0	122,900	2	THC092F4, THC102F4
BAYHTRD318A	208-230/3/60	13.5/18.0	46,100/61,400	1	THC120E3
BAYHTRD327A	208-230/3/60	20.3/27.0	69,000/92,100	2	THC120E3
BAYHTRD336A	208-230/3/60	27.0/36.0	92,100/122,900	2	THC120E3
BAYHTRD354A	208-230/3/60	40.6/54.0	138,000/184,300	2	THC120E3
BAYHTRU409A	460/3/60	9.0	30,700	1	THC072F4
BAYHTRU418A	460/3/60	18.0	61,400	1	THC072F4
BAYHTRU427A	460/3/60	27.0	92,100	2	THC072F4
BAYHTRU436A	460/3/60	36.0	122,900	2	THC072F4
BAYHTRD418A	460/3/60	18.0	61,400	1	THC120E4
BAYHTRD427A	460/3/60	27.0	92,100	2	THC120E4
BAYHTRD436A	460/3/60	36.0	122,900	2	THC120E4
BAYHTRD454A	460/3/60	54.0	184,300	2	THC120E4

For complete equipment / combination selections, installation instructions and warranty information, please refer to Product Data/Ratings and/or Installers Guides and Limited Warranty Handbooks.

**Table LPC-11-A — Accessories**

Model Number	Description	Used With
BAYABRD001C.....	ReliaTel™ Options Module.....	All T*036-120* (ReliaTel™) See Note⑤
BAYASCT001⑥⑦*	Anti-Short-Cycle Timer.....	All T*036-120* (Electro Mechanical)
BAYBARM010A④ .....	Barometric Relief .....	THC036-060*, THC036E
BAYBARM011A④ .....	Barometric Relief .....	TSC072-102*, THC092F, TSC120F, THC048*-120*
BAYBCIR001A.....	Bacnet™ Communication Interface .....	ReliaTel™ Controller (BCI-R)
BAYCCHT010B .....	Crankcase Heater .....	TSC036-048*1, 3
BAYCCHT011B .....	Crankcase Heater .....	TSC036-048*4, W
BAYCCHT017A .....	Crankcase Heater .....	TSC060F1, 3
BAYCCHT018A .....	Crankcase Heater .....	TSC060F4, EW
ASYSTAT712B③④ .....	CO <sub>2</sub> Sensor Kit, Wall Mounted.....	All T*036-120* (ReliaTel™)
ASYSTAT714B③⑧ .....	CO <sub>2</sub> Sensor Kit, Duct Mounted.....	All T*036-120* (ReliaTel™)
BAYCURB042A② .....	Roof Curb.....	THC036E, TSC036*-060*
BAYCURB043A② .....	Roof Curb.....	THC048F-072F, TSC072-102F, THC092F, TSC120F, THC102
BAYCURB044A .....	Roof Curb.....	THC120
BAYDFPS003B③⑤ .....	Clogged Filter Switch .....	All T*036-120* (ReliaTel™)
BAYDFPS004A③⑥ .....	Fan Failure Switch.....	All T*036-120* (ReliaTel™)
BAYDFPS014A .....	Clogged Filter Switch (w/MERV 13 Filter).....	All T*036-120* (ReliaTel™)
BAYDMPPR053B⑨ .....	0-50% Manual Outside Air Damper .....	THC036E, TSC036*-060*
BAYDMPPR056B⑨ .....	0-50% Manual Outside Air Damper .....	THC048*-120*, TSC072-102*, TSC120F
BAYDMPPR051A③ .....	0-50% Motorized Outside Air Damper .....	THC036E_R, TSC036-060*_R (ReliaTel™)
BAYDMPPR052A③ .....	0-50% Motorized Outside Air Damper .....	THC036E_E, TSC036E-060*_E (Electro Mechanical)
BAYDMPPR054A③ .....	0-50% Motorized Outside Air Damper .....	THC048-120*_R, TSC072-120F_R (ReliaTel™)
BAYDMPPR055A③ .....	0-50% Motorized Outside Air Damper .....	THC048-120*_E, TSC072-120F_E (Electro Mechanical)
BAYECON085A③ .....	0-100% Dry Bulb Economizer without Barometric Relief ...	THC036E_R, TSC036*-060*_R (ReliaTel™)
BAYECON086A③ .....	0-100% Dry Bulb Economizer without Barometric Relief ...	THC036E_E, TSC036*-060*_E (Electro Mechanical)
BAYECON087A③ .....	0-100% Dry Bulb Economizer without Barometric Relief ...	THC048-120*_R, TSC072*-120_R (ReliaTel™)
BAYECON088A③ .....	0-100% Dry Bulb Economizer without Barometric Relief ...	THC048-120*_E, TSC072*-120_E (Electro Mechanical)
BAYECON704A.....	Downflow Low Leak Economizer .....	THC047E-067E*R, THC048-060E*R, THC072-102F*R, THC120E*R, YSC(072-120)F*R, THC048-060F*R, THC048E-120E*E, TSC(072-120)F*E, THC(048-060)F*E, THC092F*E (ReliaTel™)
BAYECON705A.....	Downflow Low Leak Economizer .....	TSC036-060E*R, THC036E*R, THC037E*R, THC036E*E, TSC036-060E*E (ReliaTel™)
BAYENTH300A.....	Reference Enthalpy Kit (Solid State).....	BAYECON086A, 088A (Electro-Mechanical)
BAYENTH301A.....	Comparative Enthalpy Kit (Solid State) .....	BAYECON086A, 088A (Electro-Mechanical)
BAYENTH005A① .....	Reference Enthalpy Kit.....	BAYECON085A, 087A (ReliaTel™)
BAYENTH006A① .....	Comparative Enthalpy Kit.....	BAYECON086A, 087A (ReliaTel™)
BAYFRST003A③⑥ .....	High Temperature Stat .....	All T*036-120E

- ① Kits contain all necessary parts to achieve desired level of enthalpy control.
- ② Lynn Haven Manufacturing has a No-Return policy for this roof curb.
- ③ For use with ReliaTel™ controlled units only.
- ④ Barometric Relief accessory installs in ductwork for horizontal configuration. For downflow configuration, installs in the unit's horizontal return duct. See Installer's Guide for complete instructions.
- ⑤ BAYABRD001C is required when ordering field installed accessories Clogged Filter Switch (BAYDFPS003A), Fan Fail Switch (BAYDFPS004A), Discharge Air Sensing Kit (BAYTUBE004A) or Evaporator Defrost Control (Frostat) (BAYLOAM020B) Ventilation Override Kit (BAYVNOR001B) unless the following options are factory installed: Froststat, Smoke Detector, Clogged Filter Switch, Fan Failure Switch, Discharge Air Sensing Kit. These factory installed options include the ReliaTel™ Options Module.
- ⑥ For use with electromechanical controlled units only.
- ⑦ Activated on Power On.
- ⑧ Field installed accessory requires economizer.
- ⑨ The manual outside air damper will ship factory supplied within the unit, but must be field installed.

For complete equipment / combination selections, installation instructions and warranty information, please refer to Product Data/Ratings and/or Installers Guides and Limited Warranty Handbooks.

# Packaged Cooling Convertible 3-10 Tons Accessories

**Table LPC-12-A — Accessories**

Model Number	Description	Used With
BAYGARD037B	Condenser Coil Hail Guard	TSC036-060*, THC036E
BAYGARD040A	Condenser Coil Hail Guard	THC048-060F, TSC072F-090F
BAYGARD041A	Condenser Coil Hail Guard	TSC102, THC102, THC072
BAYGARD070A	Condenser Coil Hail Guard	TSC092, THC120E
BAYGARD141A	Condenser Coil Hail Guard	TSC120F, THC092F
BAYHSDR012A	High Static Drive Kit	THC072F
BAYHSMT082A	2 HP Oversized Motor Kit (208-230/460V)	TSC072F3, 4
BAYHSMT083A	2 HP Oversized Motor Kit (575V)	TSC072FW
BAYHSMT086A	3 HP Oversized Motor Kit (208-230/460V)	TSC090F-102F3, 4
BAYHSMT087A	3 HP Oversized Motor Kit (575V)	TSC090F-102FW
BAYHSMT402A	2 HP Oversized Motor Kit	THC072F3, 4
BAYKSKT255B	Start Kit	TSC036*1-060*1
BAYLMSW001A <sup>ⓐ</sup>	Power Exhaust Limit Switch	All T*036-120*, R
BAYLOAM020B <sup>①③④</sup>	Evaporator Defrost Control (Frostat)	All T*036-120*, R (ReliaTel™)
BAYLSDR006B	Low Static Drive Kit: 3-5T High Efficiency	THC036*-060*
BAYLSDR009A	Low Static Drive Kit	TSC092-102*, THC072*
BAYPWRX026A <sup>ⓐ</sup>	Power Exhaust (208-230/3 VAC)	TSC072-102F3, TSC120F3, THC072F3, THC092F3, THC102F3, THC120E3
BAYPWRX027A <sup>ⓐ</sup>	Power Exhaust (460/3 VAC)	TSC072-102F4, TSC120F4, THC072F4, THC092F4, THC102F4, THC120E4
BAYPWRX028A <sup>ⓐ</sup>	Power Exhaust (575/3 VAC)	TSC072-102FW, TSC120FW
BAYPWRX070A <sup>ⓐ</sup>	Power Exhaust (208-230/3 VAC)	TSC036-060*3, TCH036-THC060*3, THC037*3, THC047E3, THC067E3
BAYPWRX071A <sup>ⓐ</sup>	Power Exhaust (460/3 VAC)	TSC036-060*4, TCH036-THC060*4, THC037E4, THC047E4, THC067E4
BAYPWRX072A <sup>ⓐ</sup>	Power Exhaust (575/3 VAC)	TSC036-060*W
BAYQACB009A <sup>②⑤</sup>	Quick Adapt Roof Curb	TSC036-060E, THC036E, THC037E
BAYQACB010A <sup>②⑤</sup>	Quick Adapt Roof Curb	TSC036-060E, THC036E, THC037E
BAYQACB011A <sup>②⑦</sup>	Quick Adapt Roof Curb	TSC072-102F, TSC120F, THC048-072F, THC047E, THC067E
BAYQACB012A <sup>②⑦</sup>	Quick Adapt Roof Curb	TSC072-102F, TSC120F, THC048-072F, THC047E, THC067E
BAYQACB013A <sup>②⑦</sup>	Quick Adapt Roof Curb	TSC072-102F, TSC120F, THC048-072F, THC047E, THC067E
BAYRTEM001A <sup>ⓐ</sup>	Fully Featured ReliaTel™ Economizer Logic Model	All T*036-120*, R
BAYSTAT023 <sup>③</sup>	Remote Potentiometer	All T*036-120*, R
BAYSERV001A <sup>③</sup>	Selective Resistance Service Tester	All T*036-120*, R
BAYSENS016A <sup>③</sup>	Temperature Sensor	All T*036-120*, R
BAYSENS250A <sup>③②</sup>	CO <sub>2</sub> Duct Mounted, Sensor Only	All T*036-120*, R (ReliaTel™)
BAYSENS251A <sup>③②</sup>	CO <sub>2</sub> Wall Mounted, Sensor Only	All T*036-120*, R (ReliaTel™)
BAYTUBE005A	Discharge Air Sensing Kit	TSC036-060*R, THC036-037E*R
BAYTUBE007A	Discharge Air Sensing Kit	TSC072-102F*R, THC047E-072E*R
BAYTUBE401A	Discharge Air Sensing Kit	TSC120F*R, THC092F*R
BAYTUBE403A	Discharge Air Sensing Kit	TSC102-120F*R
BAYVNOR001B <sup>③④⑤</sup>	Ventilation Override Kit w/ReliaTel™ options module	All T*036-120*, R

- ① For ReliaTel™ microprocessor controlled units only. Must be factory installed for electromechanical controlled units.
- ② Lynn Haven Manufacturing has a No-Return policy for this roof curb.
- ③ For use with ReliaTel™ controlled units only.
- ④ BAYABRD001C is required when ordering field installed accessories Clogged Filter Switch (BAYDFPS003A), Fan Fail Switch (BAYDFPS004A), Discharge Air Sensing Kit (BAYTUBE004A) or Evaporator Defrost Control (Frostat) (BAYLOAM020B) Ventilation Override Kit (BAYVNOR001B) unless the following options are factory installed: Frostat, Smoke Detector, Clogged Filter Switch, Fan Failure Switch, Discharge Air Sensing Kit. These factory installed options include the ReliaTel™ Options Module.
- ⑤ BAYQACB009A adapts YCD units BAYCURB021B to accept T°C3-5 ton unit. BAYQACB010A adapts YCD units BAYCURB022B to accept T°C unit.
- ⑥ Cannot be used in conjunction with Barometric Relief. Order Economizer without Barometric Relief.
- ⑦ BAYQACB012A adapts YCD units BAYCURB025A to accept T°C 6-10 ton unit. BAYQACB013A adapts YCD units BAYCURB026A to accept T°C 6-10 ton unit.
- ⑧ Interface allows a unit with ReliaTel™ Controls to communicate with Tracer 100, Tracker, VariTrac II, and is the preferred method of communication to Tracer Summit.
- ⑨ Field installed accessory requires economizer.
- ⓐ When ordering a field installed power exhaust on a unit with electromechanical controls, BAYLMSW001A must be ordered.
- ⓑ If any version of comparative or reference enthalpy is ordered, BAYRTEM001A does not need to be ordered.
- ⓒ Order only when unit has factory installed Demand Control Ventilation option.

For complete equipment / combination selections, installation instructions and warranty information, please refer to Product Data/Ratings and/or Installers Guides and Limited Warranty Handbooks.

# Packaged Cooling Convertible 3-10 Tons, R-410A Zone Sensors / Thermostats

**Table LPC-13-A — Zone Sensors for ReliaTel™ Controlled Units**

Model Number	Description	Used With
ASYSTAT106A	Single Setpoint Manual Changeover	T*C036-120*R
ASYSTAT107A	Single Setpoint	T*C036-120*, R
ASYSTAT108A	Dual Setpoint Manual or Auto Changeover	T*C036-120*R
ASYSTAT109A	Dual Setpoint Changeover Sensor	T*C036-120*, R
ASYSTAT111A	Remote Room Sensor	
ASYSTAT777A	Programmable Night Setback w/System Function Lights (Vertical Style)	T*C036-120*R
ASYSTAT708A	Programmable Night Setback w/System Function Lights	T*C036-120*R
ASYSTAT710A	Wall Mounted Humidity Sensor	T*C036,120A,3,4,W-R,T*C036-120*_R
ASYSTAT711A	Duct Mounted Humidity Sensor	T*C036-120*,T*C036-120*_R
BAYMTPL110A	Retrofit Wall Cover Plate Kit 7.25" x 6.0"	ASYSTAT111A

\*Either standard or high efficiency models.

**Table LPC-13-B — Thermostats — Electromechanical**

Model Number	Description	Used With
ASYSTAT712B	CO2 Sensor Kit (Wall Mounted)	T*C036-120*R
ASYSTAT714B	CO2 Sensor Kit (Duct Mounted)	T*C036-120*R



### Alternating Lead/Lag – Dual Compressor Models Only —

During periods of part load operation, each compressor cycles alternately as circuit number one, equalizing compressor wear and run time. Enabled by cutting the wire (BLUE) at (RTRM) junction number J3-8. **Standard**

**Anti Short Cycle Timer (ASCT) Function** — Provides a three (3) minute minimum “ON” time and a three (3) minute minimum “OFF” time for compressors, enhances compressor reliability by ensuring proper oil return. **Standard**

**Built In Evaporator Defrost Control (EDC) Function** — Provides low ambient cooling down to 0°F. **Standard**

**Built In Fan Delay Relay (FDR) Function** — Provides custom indoor fan timing sequences for the different types of equipment, enhancing efficiency and reliability. **Standard**

**Built In Night Set Back and Unoccupied Functions**① — When using a standard dual setpoint/auto change over Zone Sensor Module (ZSM), this function is enabled by applying a short across terminal J6-11 and J6-12. Sets cooling setpoint up a minimum of 7°F, sets heating setpoint back a minimum of 7°F, forces outside air damper (if present) minimum position to zero, and forces fan operation to automatic. **Accessory (requires time clock accessory or field supplied/installed switch or contacts).**

**Built In “TEST” Mode** — Aids in quick verification of system and control operation, exercises both hardware and software (no special tools required). **Standard**

**Built In Unoccupied Mode**① — When using a standard single setpoint/manual change over Zone Sensor Module (ZSM), this function is enabled by applying a short across terminal J6-11 and J6-12. Forces outside air damper (if present) minimum position to zero, forces fan operation to automatic. **Accessory (requires time clock accessory or field supplied/installed switch or contacts).**

**Direct Digital Control (DDC)**① — Proportional Integral (PI) control. Proportional – sets corrective action proportional to deviation from setpoint. Integral – fine tunes the rate of corrective action proportional to the error (results in superior space temperature control). **Standard**

**Economizer Preferred Cooling**① — Provides fully integrated operation if required. Will not turn on a compressor with the economizer, if the space is recovering adequately with the economizer alone (0.2°F/minute). Allows the equipment to be utilized in more varied applications. **Standard with economizer accessory.**

**Emergency Stop Terminals On Low Voltage Terminal Board (LTB-5 and LTB-6)** — Provides a convenient point to disable the equipment completely, and immediately. Still provides communication to BAS. **Standard**

**Heat Pump Smart Recovery and Smart Staging**① — Inhibits auxiliary heat operation if the space is recovering adequately (0.1°F/minute) with the heat pump alone, providing considerable savings in operating costs. **Standard**

**Heat Pump Soft Start** — Provides a smooth transition into heating after defrost, minimizing noise and compressor stress associated with switch over. **Standard**

**Increased Reliability** — Fewer components (moving electro-mechanical parts), less likelihood of equipment down time or failure. **Standard**

**Integral Electric Heat Staging**① — Stages electric heaters “OFF” and “ON”, eliminating the use of outdated sequencers. **Standard**

**Intelligent Fallback**① — A built in Default Control provides adaptive operation, which allows the equipment to continue to operate, providing comfort in the event of certain component failures. Also, allows emergency operation without a Zone Sensor Module (ZSM). **Standard**

**Low Ambient Start Timer (LAST) Function** — Bypasses low pressure control when a compressor starts, eliminating nuisance compressor lock outs. **Standard**

**Lower Installation Cost** — Using a standard Zone Sensor Module (ZSM), control voltage wiring may be run up to five (5) times further than any electromechanical system, with no increase in wire gauge. Example: Electromechanical System – 30 feet maximum using 22 gauge wire. Micro Control System – 150 feet using 22 gauge wire. **Standard**

**On Board Diagnostics**① — Assist with equipment troubleshooting, if a problem occurrence should take place. **Standard**

**Remote Sensing**① — All standard Zone Sensor Modules (ZSMs) have remote sensing capabilities, typically achieved by using an expensive program-mable thermostat and remote sensor with electromechanical equipment. **Accessory (requires use of remote sensor).**

**Selectable Economizer Dry Bulb Change Over** — Allows the capability of selecting the following dry bulb change over points: 63, 67, 70 or 73°F. **Standard with economizer accessory.**

**Space Temperature Averaging**① — All standard Zone Sensor Modules (ZSMs) have space temperature averaging capabilities, typically achieved by using an expensive programmable thermostat and minimum of four (4) remote sensors with electromechanical equipment. **Averaging with ReliaTel™ can be achieved with two (2) sensors.**

**Supply Air Tempering**① — A built in feature, once enabled only through an ICS device, may also be enabled using a digital or programmable Zone Sensor Module. When in the HEAT mode (and not actively heating), if supply air temperature drops 10°F below the heating setpoint, heat is turned on until supply air temperature rises to a point 10°F above the heating setpoint. Provides temperate air during the “OFF” cycle, and eliminates cold air dumping from supply ducts. Extremely effective when introducing any quantity of fresh air. **Standard when using a RTOM, ICS device, digital, or programmable Zone Sensor Module.**

**Time Delay Relay (TDR) Function** — Provides an incremental staging delay between compressors, minimizes equipment current inrush and consumption by keeping compressors from starting simultaneously. **Standard**

**Low Pressure and High Pressure Compressor Lockout** — 3 trips will lockout control.

① Denotes features lost from utilizing standard conventional stat.

## ReliaTel™ Controls

### Operation With An Electromechanical Thermostat

---

When the ReliaTel™ RTRM Thermostat Interface is used, equipment operation differs significantly. The basic equipment protection features remain intact, and the following features and benefits are **LOST**:

- **Direct Digital Control (DDC)** – Proportional Integral (PI) control is lost, equipment is controlled by a thermostat or generic building automation system device.
- **Intelligent Fall back** is lost, if a failure occurs in the device controlling the equipment, operation will cease.
- Installation is more costly, with the addition of a thermostat or generic control, the control wiring size must be increased.
- **Heat Pump Smart Recovery and Smart Staging** is lost, Heat Pump operation becomes more costly unless generic control being applied can accomplish this.
- **Remote Sensing** capabilities are lost, unless generic control being applied can accomplish this.
- **Low ambient disabled economizer and second condensing fan cycling capability.**
- **Space Temperature Averaging** capabilities are lost, unless generic control being applied can accomplish this.
- **Supply Air Tempering** feature is lost, discharge air temperature may be cold when not actively heating if outdoor air is being introduced through the equipment.
- **Built In Night Set Back and Unoccupied** functions are lost, unless generic control being applied can accomplish this.
- **Built In Unoccupied Mode** is lost, unless generic control being applied can accomplish this.
- **Economizer Preferred Cooling Feature** is lost, all compressor operation is locked out below 50°F.

# Packaged Cooling with ReliaTel™ Controls 12½-25 Tons, R-410A

**12½-25 Ton T\*D-F – Downflow**

**12½-25 Ton T\*H-F – Horizontal**

- ReliaTel™ control features are listed on page LPC-14
- Built-in anti-short cycle, time-delay relay and minimum on time controls
- 2" throwaway filters
- Liquid line drier
- Built-in fork lift holes

- Operating charge of R-410A
- Quick-Access on 12½ – 25
- Sloped sheet metal drain pan
- Dedicated horizontal and downflow units
- Single point power for electric heat
- Complete line of optional electric heaters
- Internally enhanced coil tubing
- Low ambient to 0°F standard
- Colored and numbered wiring

- Phase monitor
- Quick-adjust idler arm pulley. Adjust belt tension, change belts, adjust airflow quickly (12½ – 25 tons), downflow only
- UL listed and CSA certified
- **5-year limited compressor warranty (12½ – 25 tons)**

**Table LPC-16-A — High Efficiency ReliaTel™ Units (R-410A)**

Tons	Unit Model No.	Power Supply Volts/Phase/Hz	Performance EER	Cooling Capacity (Btuh)	Dimensions (in.) H x W x L	Shipping Weight (lbs.)	MCA <sup>②</sup>	Max Fuse Size or Max Circuit Breaker <sup>①</sup>	Downflow <sup>③</sup> Roofcurb
12½	TH*150F3R0A000	208-230/3/60	12.1	140,000	54 x 85 <sup>5</sup> / <sub>16</sub> x 122 <sup>5</sup> / <sub>16</sub>	2373	65	80	BAYCURB027B
15	TH*180F3R0A000	208-230/3/60	12.0	172,000	64 1/8 x 85 <sup>5</sup> / <sub>16</sub> x 122 <sup>5</sup> / <sub>16</sub>	2322	72	90	BAYCURB027B
17½	TH*210F3R0A0000	208-230/3/60	11.8	198,000	64 1/8 x 85 <sup>5</sup> / <sub>16</sub> x 122 <sup>5</sup> / <sub>16</sub>	2396	88	110	BAYCURB027B
20	TH*240F3R0A0000	208-230/3/60	11.0	242000	64 1/8 x 85 <sup>5</sup> / <sub>16</sub> x 122 <sup>5</sup> / <sub>16</sub>	2399	104	125	BAYCURB027B
25	TH*300F3R0A0000	208-230/3/60	10.6	272000	64 1/8 x 85 <sup>5</sup> / <sub>16</sub> x 122 <sup>5</sup> / <sub>16</sub>	2365	116	150	BAYCURB027B
12½	TH*150F4R0A0000	460/3/60	12.1	140,000	54 x 85 <sup>5</sup> / <sub>16</sub> x 122 <sup>5</sup> / <sub>16</sub>	2373	32	40	BAYCURB027B
15	TH*180F4R0A0000	460/3/60	12.0	172,000	64 <sup>1</sup> / <sub>8</sub> x 85 <sup>5</sup> / <sub>16</sub> x 122 <sup>5</sup> / <sub>16</sub>	2322	36	45	BAYCURB027B
17½	TH*210F4R0A0000	460/3/60	11.8	198,000	64 <sup>1</sup> / <sub>8</sub> x 85 <sup>5</sup> / <sub>16</sub> x 122 <sup>5</sup> / <sub>16</sub>	2396	42	50	BAYCURB027B
20	TH*240F4R0A0000	460/3/60	11.0	242000	64 <sup>1</sup> / <sub>8</sub> x 85 <sup>5</sup> / <sub>16</sub> x 122 <sup>5</sup> / <sub>16</sub>	2399	50	60	BAYCURB027B
25	TH*300F4R0A0000	460/3/60	10.6	272000	64 <sup>1</sup> / <sub>8</sub> x 85 <sup>5</sup> / <sub>16</sub> x 122 <sup>5</sup> / <sub>16</sub>	2365	56	70	BAYCURB027B
12½	TH*150FWR0A0000	575/3/60	12.1	140,000	54 x 85 <sup>5</sup> / <sub>16</sub> x 122 <sup>5</sup> / <sub>16</sub>	2373	25	30	BAYCURB027B
15	TH*180FWR0A0000	575/3/60	12.0	172,000	64 <sup>1</sup> / <sub>8</sub> x 85 <sup>5</sup> / <sub>16</sub> x 122 <sup>5</sup> / <sub>16</sub>	2322	29	40	BAYCURB027B
17½	TH*210FWR0A0000	575/3/60	11.8	198,000	64 <sup>1</sup> / <sub>8</sub> x 85 <sup>5</sup> / <sub>16</sub> x 122 <sup>5</sup> / <sub>16</sub>	2396	36	45	BAYCURB027B
20	TH*240FWR0A0000	575/3/60	11.0	242000	64 <sup>1</sup> / <sub>8</sub> x 85 <sup>5</sup> / <sub>16</sub> x 122 <sup>5</sup> / <sub>16</sub>	2399	42	50	BAYCURB027B
25	TH*300FWR0A0000	575/3/60	10.6	272000	64 <sup>1</sup> / <sub>8</sub> x 85 <sup>5</sup> / <sub>16</sub> x 122 <sup>5</sup> / <sub>16</sub>	2365	47	60	BAYCURB027B

**Table LPC-16-B — High Efficiency ReliaTel™ Units (R-410A) - Multi Speed Indoor Fan**

Tons	Unit Model No.	Power Supply Volts/Phase/Hz	Performance EER	Cooling Capacity (Btuh)	Dimensions (in.) H x W x L	Shipping Weight (lbs.)	MCA <sup>②</sup>	Max Fuse Size or Max Circuit Breaker <sup>①</sup>	Downflow Roofcurb
12½	TH*150F3R0A1B8B	208-230/3/60	12.1	140,000	54 x 85 <sup>5</sup> / <sub>16</sub> x 122 <sup>5</sup> / <sub>16</sub>	2398	65	80	BAYCURB027B
15	TH*180F3R0A1B8B	208-230/3/60	12.0	172,000	64 <sup>1</sup> / <sub>8</sub> x 85 <sup>5</sup> / <sub>16</sub> x 122 <sup>5</sup> / <sub>16</sub>	2347	72	90	BAYCURB027B
17½	TH*210F3R0A1B8B	208-230/3/60	11.8	198,000	64 <sup>1</sup> / <sub>8</sub> x 85 <sup>5</sup> / <sub>16</sub> x 122 <sup>5</sup> / <sub>16</sub>	2421	88	110	BAYCURB027B
20	TH*240F3R0A1B8B	208-230/3/60	11.0	242000	64 <sup>1</sup> / <sub>8</sub> x 85 <sup>5</sup> / <sub>16</sub> x 122 <sup>5</sup> / <sub>16</sub>	2424	104	125	BAYCURB027B
25	TH*300F3R0A1B8B	208-230/3/60	10.6	272000	64 <sup>1</sup> / <sub>8</sub> x 85 <sup>5</sup> / <sub>16</sub> x 122 <sup>5</sup> / <sub>16</sub>	2430	116	150	BAYCURB027B
12½	TH*150F4R0A1B8B	460/3/60	12.1	140,000	54 x 85 <sup>5</sup> / <sub>16</sub> x 122 <sup>5</sup> / <sub>16</sub>	2398	32	40	BAYCURB027B
15	TH*180F4R0A1B8B	460/3/60	12.0	172,000	64 <sup>1</sup> / <sub>8</sub> x 85 <sup>5</sup> / <sub>16</sub> x 122 <sup>5</sup> / <sub>16</sub>	2347	36	45	BAYCURB027B
17½	TH*210F4R0A1B8B	460/3/60	11.8	198,000	64 <sup>1</sup> / <sub>8</sub> x 85 <sup>5</sup> / <sub>16</sub> x 122 <sup>5</sup> / <sub>16</sub>	2421	42	50	BAYCURB027B
20	TH*240F4R0A1B8B	460/3/60	11.0	242000	64 <sup>1</sup> / <sub>8</sub> x 85 <sup>5</sup> / <sub>16</sub> x 122 <sup>5</sup> / <sub>16</sub>	2424	50	60	BAYCURB027B
25	TH*300F4R0A1B8B	460/3/60	10.6	272000	64 <sup>1</sup> / <sub>8</sub> x 85 <sup>5</sup> / <sub>16</sub> x 122 <sup>5</sup> / <sub>16</sub>	2410	56	70	BAYCURB027B
12½	TH*150FWR0A1B8B	575/3/60	12.1	140,000	54 x 85 <sup>5</sup> / <sub>16</sub> x 122 <sup>5</sup> / <sub>16</sub>	2398	25	30	BAYCURB027B
15	TH*180FWR0A1B8B	575/3/60	12.0	172,000	64 <sup>1</sup> / <sub>8</sub> x 85 <sup>5</sup> / <sub>16</sub> x 122 <sup>5</sup> / <sub>16</sub>	2347	29	40	BAYCURB027B
17½	TH*210FWR0A1B8B	575/3/60	11.8	198,000	64 <sup>1</sup> / <sub>8</sub> x 85 <sup>5</sup> / <sub>16</sub> x 122 <sup>5</sup> / <sub>16</sub>	2421	36	45	BAYCURB027B
20	TH*240FWR0A1B8B	575/3/60	11.0	242000	64 <sup>1</sup> / <sub>8</sub> x 85 <sup>5</sup> / <sub>16</sub> x 122 <sup>5</sup> / <sub>16</sub>	2424	42	50	BAYCURB027B
25	TH*300FWR0A1B8B	575/3/60	10.6	272000	64 <sup>1</sup> / <sub>8</sub> x 85 <sup>5</sup> / <sub>16</sub> x 122 <sup>5</sup> / <sub>16</sub>	2410	47	60	BAYCURB027B

① HACR type circuit breaker per NEC.

② Information subject to change. Please confirm with current Product Data/Service Facts for current factory production.

③ Downflow only.

④ 278,000 in the horizontal airflow configuration.

\* Digit 3 - H = Horizontal or D = Downflow.

# Packaged Cooling with ReliaTel™ Controls 12½-25 Tons, R-410A

**12½-25 Ton T\*D-F – Downflow**

**12½-25 Ton T\*H-F – Horizontal**

- ReliaTel™ control features are listed on page LPC-14
- Built-in anti-short cycle, time-delay relay and minimum on time controls
- 2" throwaway filters
- Liquid line drier
- Built-in fork lift holes

- Operating charge of R-410A
- Quick-Access on 12½ – 25
- Sloped sheet metal drain pan
- Dedicated horizontal and downflow units
- Single point power for electric heat
- Complete line of optional electric heaters
- Internally enhanced coil tubing
- Low ambient to 0°F standard
- Colored and numbered wiring

- Phase monitor
- Quick-adjust idler arm pulley. Adjust belt tension, change belts, adjust airflow quickly (12½ – 25 tons), downflow only
- UL listed and CSA certified
- **5-year limited compressor warranty (12½ – 25 tons)**

**Table LPC-17-A — ReliaTel™ Units (R-410A) - Standard Efficiency**

Tons	Unit Model No.	Power Supply Volts/Phase/Hz	Performance EER	Cooling Capacity (Btu/h)	Dimensions (in.) H x W x L	Shipping Weight (lbs.)	MCA <sup>②</sup>	Max Fuse Size or Max Circuit Breaker <sup>①</sup>	Downflow <sup>③</sup> Roofcurb
12½	TS*150F3R0A0000	208-230/3/60	11.0	140,000	50½ x 71½ x 107½	1781	64	80	BAYCURB026B
15	TS*180F3R0A0000	208-230/3/60	11.0	176,000	54 x 85½ x 122½	2281	75	100	BAYCURB027B
17½	TS*210F3R0A0000	208-230/3/60	11.0	193,000	54 x 85½ x 122½	2292	93	125	BAYCURB027B
20	TS*240F3R0A0000	208-230/3/60	10.0	240,000	54 x 85½ x 122½	2353	108	125	BAYCURB027B
25	TS*300F3R0A0000	208-230/3/60	10.0	272,000	54 x 85½ x 122½	2337	124	150	BAYCURB027B
12½	TS*150F4R0A0000	460/3/60	11.0	140,000	50½ x 71½ x 107½	1781	31	40	BAYCURB026B
15	TS*180F4R0A0000	460/3/60	11.0	176,000	54 x 85 5/16 x 122½	2281	28	50	BAYCURB027B
17½	TS*210F4R0A0000	460/3/60	11.0	193,000	54 x 85 5/16 x 122½	2292	44	60	BAYCURB027B
20	TS*240F4R0A0000	460/3/60	10.0	240,000	54 x 85 5/16 x 122½	2353	52	70	BAYCURB027B
25	TS*300F4R0A0000	460/3/60	10.0	272,000	54 x 85 5/16 x 122½	2337	59	70	BAYCURB027B
12½	TS*150FWR0A0000	575/3/60	11.0	140,000	50½ x 71½ x 107½	1781	23	30	BAYCURB026B
15	TS*180FWR0A0000	575/3/60	11.0	176,000	54 x 85½ x 122½	2281	31	40	BAYCURB027B
17½	TS*210FWR0A0000	575/3/60	11.0	193,000	54 x 85½ x 122½	2292	35	50	BAYCURB027B
20	TS*240FWR0A0000	575/3/60	10.0	240,000	54 x 85½ x 122½	2353	44	60	BAYCURB027B
25	TS*300FWR0A0000	575/3/60	10.0	272,000	54 x 85½ x 122½	2337	48	60	BAYCURB027B

**Table LPC-17-B — ReliaTel™ Units (R-410A) - Standard Efficiency - Multi Speed Indoor Fan**

Tons	Unit Model No.	Power Supply Volts/Phase/Hz	Performance EER	Cooling Capacity (Btu/h)	Dimensions (in.) H x W x L	Shipping Weight (lbs.)	MCA <sup>②</sup>	Max Fuse Size or Max Circuit Breaker <sup>①</sup>	Downflow Roofcurb
12½	TS*150F3R0A1B8B	208-230/3/60	11.0	140,000	50½ x 71½ x 107½	1806	64	80	BAYCURB026B
15	TS*180F3R0A1B8B	208-230/3/60	11.0	176,000	54 x 85½ x 122½	2306	75	100	BAYCURB027B
17½	TS*210F3R0A1B8B	208-230/3/60	11.0	193,000	54 x 85½ x 122½	2317	93	125	BAYCURB027B
20	TS*240F3R0A1B8B	208-230/3/60	10.0	240,000	54 x 85½ x 122½	2378	108	125	BAYCURB027B
25	TS*300F3R0A1B8B	208-230/3/60	10.0	272,000	54 x 85½ x 122½	2402	124	150	BAYCURB027B
12½	TS*150F4R0A1B8B	460/3/60	11.0	140,000	50½ x 71½ x 107½	1806	31	40	BAYCURB026B
15	TS*180F4R0A1B8B	460/3/60	11.0	176,000	54 x 85½ x 122½	2306	28	50	BAYCURB027B
17½	TS*210F4R0A1B8B	460/3/60	11.0	193,000	54 x 85½ x 122½	2317	44	60	BAYCURB027B
20	TS*240F4R0A1B8B	460/3/60	10.0	240,000	54 x 85½ x 122½	2378	52	70	BAYCURB027B
25	TS*300F4R0A1B8B	460/3/60	10.0	272,000	54 x 85½ x 122½	2382	59	70	BAYCURB027B
12½	TS*150FWR0A1B8B	575/3/60	11.0	140,000	50½ x 71½ x 107½	1806	23	30	BAYCURB026B
15	TS*180FWR0A1B8B	575/3/60	11.0	176,000	54 x 85½ x 122½	2306	31	40	BAYCURB027B
17½	TS*210FWR0A1B8B	575/3/60	11.0	193,000	54 x 85½ x 122½	2317	35	50	BAYCURB027B
20	TS*240FWR0A1B8B	575/3/60	10.0	240,000	54 x 85½ x 122½	2378	44	60	BAYCURB027B
25	TS*300FWR0A1B8B	575/3/60	10.0	272,000	54 x 85½ x 122½	2382	48	60	BAYCURB027B

① HACR type circuit breaker per NEC.

② Information subject to change. Please confirm with current Product Data/Service Facts for current factory production.

③ Downflow only.

④ 278,000 in the horizontal airflow configuration.

\* Digit 3 - H = Horizontal or D = Downflow.

# Packaged Cooling with ReliaTel™ Controls 12½-25 Tons (Model Digit Numbers)

Digit	Description	Order Number	Digit	Description	Order Number
1	<b>Unit Type</b>			Through The Base Electric/Gas <sup>①</sup> .....	C
	Packaged Cooling, Electric Heat.....	T		Through The Base Access <sup>①</sup> .....	D
2	<b>Efficiency</b>		19	<b>Disconnect Switch/Circuit Breaker</b>	
	Standard Efficiency.....	S		No Disconnect/circuit break.....	0
3	<b>Airflow Configuration</b>			Unit Mounted Non-Fused Disconnect Switch.....	1
	Downflow.....	D		Unit Mounted Circuit Breaker.....	2
4-6	<b>Nominal Gross Cooling Capacity (MBh)</b>		20	<b>Convenience Outlet Option</b>	
	12½ Tons.....	150		Without Convenience Outlet.....	0
	15 Tons.....	180		Unpowered Convenience Outlet.....	A
	17½ Tons.....	210		Powered Convenience Outlet.....	B
	20 Tons.....	240			
7	<b>Major Design Sequence</b>		21	<b>Communications Options</b>	
	Microchannel Type Condenser Coils.....	F		Without Communications Options.....	0
8	<b>Voltage Selection</b>			Novar 2024 Controls Interface <sup>④</sup> .....	3
	208-230/60/3.....	3		Novar 3051 Controls Interface <sup>④</sup> .....	4
	460/60/3.....	4		Novar 3051 Communications Interface with Demand Control Ventilation <sup>③</sup> .....	5
	575/60/3.....	W		Building Automation Control Network Communications Interface.....	6
9	<b>Unit Controls</b>		22	<b>Refrigeration System Option</b>	
	ReliaTel™.....	R		Standard refrigeration system.....	0
10	<b>Heating Capacity</b>			Thermal Expansion Valve (TXV).....	A
	No Heat <sup>②</sup> .....	0		Dehumidification (Hot Gas Reheat).....	B
	18 kW Electric Heat <sup>②</sup> .....	G	23	<b>Refrigeration Controls</b>	
	27 kW Electric Heat <sup>②</sup> .....	K		Without Refrigeration Controls.....	0
	36 kW Electric Heat <sup>②</sup> .....	N		Frostat.....	1
	54 kW Electric Heat <sup>②</sup> .....	P	24	<b>Smoke Detector</b>	
	72 kW Electric Heat <sup>②</sup> .....	R		Without Smoke Detector.....	0
	Gas Heat - Low <sup>①</sup> .....	L		Return Air Smoke Detector.....	A
Gas Heat - SS Ht Ex - Modulating <sup>①</sup> .....	V		Supply Air Smoke Detector.....	B	
Gas Heat - SS Ht Ex - Low <sup>①</sup> .....	X	25	<b>System Monitoring Controls</b>		
Gas Heat - SS Ht Ex - High <sup>①</sup> .....	Z		No Monitoring Controls.....	0	
11	<b>Minor Design Sequence</b>			Clogged Filter Switch.....	1
12-13	<b>Service Sequence</b>			Fan Failure Switch.....	2
14	<b>Fresh Air Selection</b>			Discharge Air Sensing.....	3
	No Fresh Air.....	0		Clogged Filter Switch and Fan Failure switch.....	4
	Econ Dry Bulb w/ Barometric Relief.....	D		Clogged Filter Switch and Discharge Air Sensing.....	5
	Econ Reference Enthalpy w/Barometric Relief.....	F		Fan Failure Switch and Discharge Air Sensing.....	6
	Econ Comparative Enthalpy w/Barometric Relief.....	H		Clogged Filter Switch, Fan Failure Switch and Discharge Air Sensing.....	7
	Low Leak Economizer, Dry Bulb with Barometric Relief.....	K		NOVAR Return Air Sensor (Novar 2024) <sup>④</sup> .....	8
	Low Leak Economizer, Comparative Enthalpy with Barometric Relief.....	M		NOVAR Zone Temp Sensor(Novar 3051) <sup>④</sup> .....	9
	Low Leak Economizer, Reference Enthalpy with Barometric Relief.....	P		Condensate Drain Pan Overflow Switch.....	A
				Clogged Filter Switch and Condensate Drain Pan Overflow Switch.....	B
				Fan Failure Switch and Condensate Drain Pan Overflow Switch.....	C
				Discharge Air Sensing and Condensate Drain Pan Overflow Switch.....	D
	15	<b>Supply Fan/Drive Type/Motor</b>			Clogged Filter Switch, Fan Failure Switch and Condensate Drain Pan Overflow Switch.....
Standard Motor.....		0		Clogged Filter Switch, Discharge Air Sensing Tube and Condensate Drain Pan Overflow Switch.....	F
Oversized Motor.....		1		Fan Failure Switch, Discharge Air Sensing Tube and Condensate Drain Pan Overflow Switch.....	G
High Efficiency Motor.....		3	26	<b>System Monitoring Controls</b>	
Single Zone Variable Air Volume Standard Motor.....		6		No Monitoring Controls.....	0
Multi-Speed Standard Motor.....		7		Demand Control Ventilation (CO <sub>2</sub> ) <sup>⑤</sup> .....	A
Single Zone Variable Air Volume Oversized Motor.....		8		Fault Detection and Diagnostics (FDD).....	B
Multi-Speed Oversized Motor.....		9		Fault Detection and Diagnostics (FDD) with Demand Control Ventilation.....	C
Single Zone Variable Air Volume Standard Motor w/Shaft Ground Ring.....		A	27	<b>Unit Hardware Enhancements</b>	
Multi-Speed Standard Motor w/Shaft Ground Ring.....		B		No Enhancements.....	0
Single Zone Variable Air Volume Oversized Motor w/Shaft Ground Ring.....	C		Stainless Steel Drain Pan.....	1	
Multi-Speed Oversized Motor w/Shaft Ground Ring.....	D	28	<b>Short Circuit Current Rating (SCCR)</b>		
			Standard SCCR.....	0	
16	<b>Hinged Service Access / Filters</b>			65 kA SCCR.....	A
	Standard Panels/Standard Filters.....	0	31	<b>Advanced Unit Controls</b>	
	Hinged Access/Standard Filters.....	A		Standard Unit Controls.....	0
	Standard Panels/MERV 8 Filters.....	B		Human Interface.....	1
	Hinged Access/MERV 8 Filters.....	C			
Standard Panels/MERV 13 Filters.....	D				
Hinged Access/MERV 13 Filters.....	E				
17	<b>Condenser Coil Protection</b>				
	Standard Coil.....	0			
	Standard Coil With Hail Guard.....	1			
	CompleteCoat™ Condenser Coil.....	4			
CompleteCoat™ Condenser Coil with Hail Guard.....	5				
18	<b>Through The Base Provisions.</b>				
	No Through The Base Provisions <sup>③</sup> .....	0			
	Through The Base Electric <sup>③</sup> .....	A			
	Through The Base Gas <sup>①</sup> .....	B			

**Note:** Most Factory Installed Options available for Downflow Air Discharge units only. Please verify with ordering system for availability.

① Applicable to Digit 1 Y models only.  
② Applicable to Digit 1 T models only.  
③ Applicable to Digit 1, T or Y models.

④ Novar is not available with SZ VAV products.  
⑤ Demand Control Ventilation Option includes wiring only. The CO<sub>2</sub> sensor is a field-installed only option.

**For additional Controls Information:  
See ReliaTel™ and Micro Control features on PC-17 and PC-18.**

For complete equipment / combination selections, installation instructions and warranty information, please refer to Product Data/Ratings and/or Installers Guides and Limited Warranty Handbooks.

## Packaged Cooling with ReliaTel™ Controls 12½-25 Tons, R-410A Zone Sensors / Thermostats

**Table LPC-19-B — Zone Sensors for ReliaTel™**

Model Number	Description	Used With
ASYSTAT106A	Single Setpoint Manual Changeover	YC*150-301
ASYSTAT108A	Dual Setpoint Manual or Automatic Changeover	YC*150-301
ASYSTAT111A	Remote Room Sensor	ASYSTAT777A
ASYSTAT777A	Programmable Night Setback	YC*150-301
ASYSTAT710A	Wall Mounted Humidity Sensor	YFD151,181,241 (with Reheat)
ASYSTAT711A	Duct Mounted Humidity Sensor	YFD151,181,241 (with Reheat)
BAYMTPL110A	Retrofit Wall Cover Plate Kit 7.25" x 6.0"	ASYSTAT777A

# Packaged Cooling with ReliaTel™ Controls 12½-25 Tons Accessories

**Table LPC-20-A — Field Installed Accessories**

For complete list of of All Factory Installed Options refer to FIOPS section of this book.

Model Number	Description	Used With
BAYBCIR001A	BACnet™ Communication Interface	All Voyagers
BAYABRD002B <sup>⑨</sup>	ReliaTel™ Options Module	All Voyagers
BAYCO2K002B <sup>⑩</sup>	CO <sub>2</sub> Sensor Wall Mounted	All Voyagers w/Economizers
BAYCO2K004B <sup>⑩</sup>	CO <sub>2</sub> Sensor Duct Mounted	All Voyagers w/Economizers
BAYCURB026B <sup>⑤⑥</sup>	Downflow Roof Curb (Can not be adapted for horizontal use)	TSD150F
BAYCURB027B <sup>⑤⑥</sup>	Downflow Roof Curb (Can not be adapted for horizontal use)	THD150F-300F, TSD180-300F
BAYDFPS005A <sup>③④</sup>	Clogged Filter Switch (MERV 7)	All Voyagers
BAYDFPS006A <sup>③④</sup>	Fan Failure Switch	All Voyagers
BAYDFPS013A	Clogged Filter Switch (MERV 13)	All Voyagers
BAYDMPR029C	0-25% Manual Outside Air Damper	All Voyagers
BAYDMPR057A	0-50% Motorized Outside Air Damper	TSD150F
BAYDMPR058A	0-50% Motorized Outside Air Damper	TSD151F-300F, TSD180F-300F
BAYECON089A <sup>②</sup>	Downflow Economizer with Barometric Relief	TSD150F
BAYECON090A <sup>②</sup>	Downflow Economizer with Barometric Relief	TSD151F-300F, TSD180F-300F
BAYECON091A	Horizontal Economizer	TSH150F
BAYECON092A	Horizontal Economizer	TSH151F-300F, TSF180F-300F
BAYECON700A	Downflow Low Leak Economizer	TSD150F
BAYECON701A	Downflow Low Leak Economizer	TSD180F-300F, THD150F, THD180-300F
BAYENTH007A <sup>①②</sup>	Reference Enthalpy Kit	All BAYECON089-92A
BAYENTH008A <sup>①③</sup>	Comparative Enthalpy Kit	All BAYECON089-92A
BAYFRST003A <sup>⑦</sup>	High Temperature Stat	All Voyagers
BAYGARD144A <sup>④</sup>	Tool-less Hail Guard	TS*150F
BAYGARD145A <sup>④</sup>	Tool-less Hail Guard	TH*150F, TS*210F, TS*240F, TS*300F
BAYGARD150A	Tool-less Hail Guard	TH*180F, TH*210F, TH*240F, TH*300F
BAYHSDR005B <sup>④</sup>	High Static Drive	TS*150F, TH*150F, TH*180F
BAYHSDR010A <sup>④</sup>	High Static Drive	TH*210F, TH*240F, TS*300F
BAYHSDR011A <sup>④</sup>	High Static Drive	TS*210F, TS*240F, TH*300F
BAYHSDR016A	High Static Drive	TS*180F

- ① Kit contains all necessary parts to achieve desired level of Enthalpy Control.
- ② Reference Enthalpy senses outside temperature/humidity and inside return/mixed air temperature/humidity.
- ③ Comparative Enthalpy senses outside temperature/humidity and inside return/mixed air temperature/humidity.
- ④ High static drive and oversized motors are mutually exclusive, Do Not Combine.
- ⑤ Clarksville manufacturing has a no return policy for this roof curb.
- ⑥ For downflow use only. Can not be adapted for horizontal units.
- ⑦ Must be used with either field or factory installed TCI (Trane Communications Interface).
- ⑧ BAYABRD002B is required when ordering field installed BAYDFPS005A or 006A, BAYTUBE008A or 009A and BAYLOAM023A or BAYVNOR002B.
- ⑨ Field or factory installed option.
- ⑩ Field installed accessory. Requires an economizer.

**Table LPC-21-A — Field Installed Accessories**

For complete list of of All Factory Installed Options refer to FIOPS section of this book.

Model Number	Description	Used With
BAYHSMT039B①⑥	5HP Oversized Motor Kit (208-230/460V)	TS*150F
BAYHSMT040B①⑥	5HP Oversized Motor Kit (575V)	TS*150F
BAYHSMT055B①⑥	5HP Oversized Motor Kit (208-230/460V)	TS*180F
BAYHSMT042A①⑥	7-1/2HP Oversized Motor Kit (575V)	TS*210F, TH*210F, TS*240F, TH*240F
BAYHSMT072A①⑥	7-1/2HP Oversized Motor Kit (575V)	TS*180F, TH*180F
BAYHSMT098A①⑥	7-1/2HP Oversized Motor Kit (208-230V)	TH*210F, TH*240F
BAYHSMT099A①⑥	7-1/2HP Oversized Motor Kit (460V)	TH*210F, TH*240F
BAYLOAM023A⑥	Evaporator Defrost Control Frostat	TS*150F, TH*150F, TS*180F TS*210F, TS*240F, TS*300F
BAYLOAM031A	Evaporator Defrost Control Frostat	TH*180F, TH*210F, TH*240F, TH*300F
BAYLSDR004A②	Low Static Drive	TS*150F, TS*180F, TS*210F TH*210F, TH*240F, TS*240F
BAYLSDR002A②	Low Static Drive	TH*150F, TH*180F, TH*300F
BAYPWRX029A	Power Exhaust for all Voyagers 12½-25 Ton 230V units	BAYECON089-090A, TCD150-301
BAYPWRX030A	Power Exhaust for all Voyagers 12½-25 Ton 460V units	BAYECON089-090A, TCD150-301
BAYPWRX031A	Power Exhaust for all Voyagers 12½-25 Ton 575V units	BAYECON089-090A, TCD150-301
BAYSERV001A	Selective Resistance Service Tester	All TC*150F-TC*301F
BAYSTAT023③	Remote Potentiometer	All Economizers and 0-50% Motorized Air Dampers
BAYTUBE008A④⑤⑥	Discharge Air Sensing Kit	All TCD150F-TCD301F
BAYTUBE009A④⑤⑥	Discharge Air Sensing Kit	All TCH150F-TCH301F
BAYQACB044A	Adapter Curb	BAYCURB026A/B to BAYCURB027A/B
BAYVNOR002B⑤	Ventilation Override Kit	TC*150-301 w/ReliaTel™ Options Module

- ① High static drive and oversized motors are mutually exclusive, Do Not Combine.
- ② Low static drive and oversized motors are mutually exclusive, Do Not Combine.
- ③ Cannot be used with Integrated Comfort™ Systems.
- ④ Used for true discharge air sensing in both heating and cooling models.
- ⑤ BAYABRD002B is required when ordering field installed BAYDFPS005A or 006A, BAYTUBE008A or 009A and BAYLOAM031A or BAYVNOR002B.
- ⑥ Field or factory installed option.



# Packaged Cooling with ReliaTel™ Controls 12½-25 Tons Heaters

**Table LPC-22-A — Downflow Supplementary Heaters:**

Model Number	Power Supply	kW Rating	Nominal BTUH	No. Stages	Used With
AYDHTRK318A	208-230/3/60	13.5/18.0	46,100/61,400	1	TSD150F-180F, THD150F-180F
AYDHTRK336A	208-230/3/60	27.0/36.0	92,200/122,900	2	TSD150F-180F, THD150F-180F
AYDHTRK354A	208-230/3/60	40.5/54.0	138,200/184,300	2	TSD150F-180F, THD150F-180F
AYDHTRL418A	460/3/60	18.0	61,400	1	TSD150F-180F, THD150F-180F
AYDHTRK427A	460/3/60	27.0	92,150	2	THD180F
AYDHTRK436A	460/3/60	36.0	122,900	2	TSD150F-180F, THD150F-180F
AYDHTRK454A	460/3/60	54.0	184,300	2	TSD150F-180F, THD150F-180F
AYDHTRL336A	208-230/3/60	27.0/36.0	92,200/122,900	2	TSD210F-300F, THD210-300F
AYDHTRL354A	208-230/3/60	40.5/54.0	138,200/184,300	2	TSD210F-300F, THD210-300F
AYDHTRK372A	208-230/3/60	54.0/72.0	184,300/245,700	2	TSD210F-300F, THD210-300F
AYDHTRL427A	460/3/60	27.0	92,150	2	THD210F, THD240-300F
AYDHTRL436A	460/3/60	36.0	122,900	2	TSD210F-300F, THD210-300F
AYDHTRL454A	460/3/60	54.0	184,300	2	TSD210F-300F, THD210-300F
AYDHTRK472A	460/3/60	72.0	245,700	2	TSD210F-300F, THD210-300F

**Table LPC-22-B — Horizontal Supplementary Heaters:**

Model Number	Power Supply	kW Rating	Nominal BTUH	No. Stages	Used With
AYHHTRN318A	208-230/3/60	13.5/18.0	46,000/61,400	1	TSH150F, TSH180F
AYHHTRP336A	208-230/3/60	27.0/36.0	92,200/122,900	2	TSH150F, TSH180F
AYHHTRP354A	208-230/3/60	40.5/54.0	138,200/184,300	2	TSH150F, TSH180F
AYHHTRN418A	460/3/60	18.0	61,400	1	TSH150F, TSH180F
AYHHTRP436A	460/3/60	36.0	122,900	2	TSH150F, TSH180F
AYHHTRP454A	460/3/60	54.0	184,300	2	TSH150F, TSH180F
AYHHTRN336A	208-230/3/60	27.0/36.0	92,200/122,900	2	TSH210-300F, THH210-300F
AYHHTRN354A	208-230/3/60	40.5/54.0	138,200/184,300	2	TSH210-300F, THH210-300F
AYHHTRN372A	208-230/3/60	54.0/72.0	184,300/245,700	2	TSH210-300F, THH210-300F
AYHHTRN436A	460/3/60	36.0	122,900	2	TSH210-300F, THH210-300F
AYHHTRN454A	460/3/60	54.0	184,300	2	TSH210-300F, THH210-300F
AYHHTRN472A	460/3/60	72.0	245,700	2	TSH210-300F, THH210-300F
AYHHTRM318A	208-230/3/60	13.5/18.0	46,100/61,400	1	THH150F, THH180F
AYHHTRM336A	208-230/3/60	27.0/36.0	92,200/122,900	2	THH150F, THH180F
AYHHTRM354A	208-230/3/60	40.5/54.0	138,200/184,300	2	THH150F, THH180F
AYHHTRM418A	460/3/60	18.0	61,400	1	THH150F, THH180F
AYHHTRM436A	460/3/60	36.0	122,900	2	THH150F, THH180F
AYHHTRM454A	460/3/60	54.0	184,300	2	THH150F, THH180F

Note: Unit with heater is single circuit/single point.

# Packaged Cooling with ReliaTel™ Controls 12½-25 Tons Heaters

**Table LPC-23-A — Downflow Supplementary Heaters:**

Model Number	Power Supply	kW Rating	Nominal BTUH	No. Stages	Used With
AYDHTRLW54A	575/3/60	54.0	184,300	2	TSD210-300F, THD210-300F
AYDHTRKW18A	575/3/60	18.0	61,400	1	TSD150-180F, THD150-180F
AYDHTRKW54A	575/3/60	54.0	184,300	2	TSD150-180F, THD150-180F
AYDHTRKW72A	575/3/60	72.0	245,700	2	TSD210-300F, THD210-300F
AYDHTRMW36A	575/3/60	36.0	122,900	2	TSD150-300F, THD150-300F

**Table LPC-23-B — Horizontal Supplementary Heaters:**

Model Number	Power Supply	kW Rating	Nominal BTUH	No. Stages	Used With
AYHHTRMW18A	575/3/60	18.0	61,400	1	THH150F, THH180F
AYHHTRMW36A	575/3/60	36.0	122,900	2	TSH210F-300F, TSH150F-300F
AYHHTRMW54A	575/3/60	54.0	184,300	2	THH150F, THH180F
AYHHTRNW18A	575/3/60	18.0	61,400	1	TSH150F, TSH180F
AYHHTRNW54A	575/3/60	54.0	184,300	2	TSH210F-300F, THH210F-300F
AYHHTRNW72A	575/3/60	72.0	245,700	2	TSH210F-300F, THH210F-300F
AYHHTRPW36A	575/3/60	36.0	122,900	2	TSH150F, TSH180F
AYHHTRPW54A	575/3/60	54.0	184,300	2	TSH150F, TSH180F

Note: Unit with heater is single circuit/single point.

**For additional Controls Information:  
See ReliaTel™ and Micro Control features on LPC-14 and LPC-15.**

For complete equipment / combination selections, installation instructions and warranty information, please refer to Product Data/Ratings and/or Installers Guides and Limited Warranty Handbooks.

# Foundation™ Packaged Cooling 15-25 Tons, R-410A



- Scroll compressors on all units
- Operating charge of R-410A
- Low ambient operation to 40°F as standard
- Color coded and numbered wiring
- Single side service access
- Molded handles on service access doors
- Separated high and low voltage compartments
- Liquid Line Refrigerant Drier
- Provisions for through the base connections
- Phase monitor on all units
- Convertible airflow
- Two inch throwaway filters as standard
- Non-corrosive & removable drain pan
- **5-year limited compressor warranty (15-25 tons)**

**Table PC-24-A — Foundation™ — R-410A — Electromechanical Controls**

Tons	Unit Model No.	Power Supply Volts/Phase/Hz	Performance EER	Cooling Capacity (Btuh)	Dimensions (in.) H x W x L	Shipping Weight (lbs.)	MCA	Max Fuse Size or Max Circuit Breaker <sup>Ⓞ</sup>	Downflow Roofcurb
15	EAC180A3E0A0000	208-230/3/60	11.0	183,000	58 <sup>5</sup> / <sub>8</sub> x 86 <sup>15</sup> / <sub>16</sub> x 123 <sup>1</sup> / <sub>8</sub>	2,020	79	100	BAYCURB027B
17 <sup>1</sup> / <sub>2</sub>	EAC210A3E0A0000	208-230/3/60	11.0	212,000	58 <sup>5</sup> / <sub>8</sub> x 86 <sup>15</sup> / <sub>16</sub> x 123 <sup>1</sup> / <sub>8</sub>	2,074	91	110	BAYCURB027B
20	EAC240A3E0A0000	208-230/3/60	10.0	252,000	58 <sup>5</sup> / <sub>8</sub> x 86 <sup>15</sup> / <sub>16</sub> x 123 <sup>1</sup> / <sub>8</sub>	2,163	117	150	BAYCURB027B
25	EAC300A3E0A0000	208-230/3/60	10.0	290,000	58 <sup>5</sup> / <sub>8</sub> x 86 <sup>15</sup> / <sub>16</sub> x 123 <sup>1</sup> / <sub>8</sub>	2,208	124	150	BAYCURB027B
15	EAC180A4E0A0000	460/3/60	11.0	183,000	58 <sup>5</sup> / <sub>8</sub> x 86 <sup>15</sup> / <sub>16</sub> x 123 <sup>1</sup> / <sub>8</sub>	2,020	37	45	BAYCURB027B
17 <sup>1</sup> / <sub>2</sub>	EAC210A4E0A0000	460/3/60	11.0	212,000	58 <sup>5</sup> / <sub>8</sub> x 86 <sup>15</sup> / <sub>16</sub> x 123 <sup>1</sup> / <sub>8</sub>	2,074	42	50	BAYCURB027B
20	EAC240A4E0A0000	460/3/60	10.0	252,000	58 <sup>5</sup> / <sub>8</sub> x 86 <sup>15</sup> / <sub>16</sub> x 123 <sup>1</sup> / <sub>8</sub>	2,163	53	70	BAYCURB027B
25	EAC300A4E0A0000	460/3/60	10.0	290,000	58 <sup>5</sup> / <sub>8</sub> x 86 <sup>15</sup> / <sub>16</sub> x 123 <sup>1</sup> / <sub>8</sub>	2,208	56	70	BAYCURB027B
15	EAC180AWE0A0000	575/3/60	11.0	183,000	58 <sup>5</sup> / <sub>8</sub> x 86 <sup>15</sup> / <sub>16</sub> x 123 <sup>1</sup> / <sub>8</sub>	2,020	31	40	BAYCURB027B
17 <sup>1</sup> / <sub>2</sub>	EAC210AWE0A0000	575/3/60	11.0	212,000	58 <sup>5</sup> / <sub>8</sub> x 86 <sup>15</sup> / <sub>16</sub> x 123 <sup>1</sup> / <sub>8</sub>	2,074	34	40	BAYCURB027B
20	EAC240AWE0A0000	575/3/60	10.0	252,000	58 <sup>5</sup> / <sub>8</sub> x 86 <sup>15</sup> / <sub>16</sub> x 123 <sup>1</sup> / <sub>8</sub>	2,163	42	50	BAYCURB027B
25	EAC300AWE0A0000	575/3/60	10.0	290,000	58 <sup>5</sup> / <sub>8</sub> x 86 <sup>15</sup> / <sub>16</sub> x 123 <sup>1</sup> / <sub>8</sub>	2,208	47	60	BAYCURB027B

<sup>Ⓞ</sup> HACR Circuit Breaker Type Per NEC.

Information subject to change. Please confirm with current Product Data for current factory production.

**Table LPC-25-A — Foundation™ - R-410A - Field Installed Accessories**

Model Number	Description	Used With
BAYTBUE300A.....	Through the Base Electrical Connections .....	All Foundation 15-25 Ton Units
BAYDSCF300A.....	Unit Mounted Disconnect, 100 Amp .....	EAC180A4* - EAC300A4*, EAC180AW* - EAC300AW*
	Not for use when electric heat installed	
BAYDSCF301A.....	Unit Mounted Disconnect, 150 Amp .....	EAC180A3* - EAC300A3*
	Not for use when electric heat installed	
BAYDSCF302A	Unit Mounted Disconnect, 100 Amp .....	BAYHTFA318A, BAYHTFA418A, BAYHTFAW18A, BAYHTFA436A, BAYHTFA454A, BAYHTFBW36A, BAYHTFAW54A, BAYHTFBW54A, BAYHTFBW72A, BAYHTFAW72A
BAYDSCF303A.....	Unit Mounted Disconnect, 150 Amp .....	BAYHTFA472A, BAYHTF4372A, BAYHTFA336A, BAYHTFB336A, BAYHTFB454A
BAYDSCF304A.....	Unit Mounted Disconnect, 250 Amp .....	BAYHTFA372A, BAYHTFB372A, BAYHTFA354A, BAYHTFAW36A
BAYDMPR301A.....	Damper, Manual .....	EAC180A* - EAC300A*
BAYDMPR300A.....	Damper, Motorized .....	EAC180A* - EAC300A*
BAYECON300A.....	Economizer, Dry Bulb, Downflow.....	EAC180A* - EAC300A*
BAYECON301A.....	Economizer, Dry Bulb, Horizontal.....	EAC180A* - EAC300A*
BAYECON350A③.....	Low Leak Economizer w/FDD, Dry Bulb, Downflow .....	EAC180A* - EAC300A*
BAYECON351A.....	Low Leak Economizer w/FDD, Dry Bulb, Horizontal.....	EAC180A* - EAC300A*
BAYHZCN300A.....	Horizontal Economizer Conversion Kit .....	EAC180A* - EAC300A*
BAYBARO300A.....	Barometric Relief Damper, 15-25T .....	EAC180A* - EAC300A*
BAYENTH300A.....	Reference Enthalpy Economizer Kit.....	EAC180A* - EAC300A*
BAYENTH301A.....	Comparative Enthalpy Economizer Kit .....	EAC180A* - EAC300A*
BAYENTH302A③.....	Reference Enthalpy Economizer Kit .....	EAC180A* - EAC300A* w/Low Leak Economizer & FDD
BAYENTH303A③.....	Comparative Enthalpy Economizer Kit .....	EAC180A* - EAC300A* w/Low Leak Economizer & FDD
BAYCURB027B.....	Roof Curb .....	EAC180A* - EAC300A*
BAYHZRT001A.....	Horizontal Duct Conversion Kit.....	EAC180A* - EAC300A*
BAYCARR001A.....	Carrier Replacement Conversion Kit .....	EAC180A* - EAC300A*
BAYGARD300A.....	Condenser Hail Guard.....	EAC180A* - EAC300A*
BAYCCHT300A.....	Crankcase Heater, 70W, 230V .....	EAC180A3* - EAC300A3*
BAYCCHT301A.....	Crankcase Heater, 70W, 460V .....	EAC180A4* - EAC300A4*
BAYCCHT302A.....	Crankcase Heater, 70W, 575V .....	EAC180AW* - EAC300AW*
BAYASCT001.....	Compressor Short Cycle Timer .....	EAC180A* - EAC300A*
BAYLOAM300A.....	Low Ambient Control .....	EAC180A* - EAC300A*
BAYLOAM310A.....	Evaporator Defrost Control .....	EAC180A* - EAC300A*
BAYPWRX300A①.....	Power Exhaust, 15-25T, DF, 230V .....	EAC180A3* - EAC300A3*
BAYPWRX301A①.....	Power Exhaust, 15-25T, DF, 460V .....	EAC180A4* - EAC300A4*
BAYPWRX302A①.....	Power Exhaust, 15-25T, DF, 575V .....	EAC180AW* - EAC300AW*
BAYHSMT300A.....	High Static Motor & Drv, 5HP 230/460V .....	EAC180A3, EAC180A4
BAYHSMT301A.....	High Static Motor & Drv, 5HP 575V .....	EAC180AW
BAYHSMT302A.....	High Static Motor & Drv, 7.5HP 230/460V .....	EAC210A3, EAC240A3
BAYHSMT303A.....	High Static Motor & Drv, 7.5HP 460V .....	EAC210A4, EAC240A4
BAYHSMT304A.....	High Static Motor & Drv, 7.5HP 575V .....	EAC210AW, EAC240AW
BAYSHGR003A②.....	Shaft Grounding Ring, 0.875" Shaft .....	Used With 5HP VFD Motors
BAYSHGR002A②.....	Shaft Grounding Ring, 1.125" Shaft .....	Used With 7.5HP VFD Motors
BAYLSDR300A.....	Low Static Drive Option .....	EAC180A* - EAC300A*
BAYHSDR300A.....	High Static Drive Option .....	EAC180A* - EAC300A*
BAYCO2K300A.....	Wall Mounted CO2 Sensor .....	EAC180A* - EAC300A* with economizer
BAYCO2K301A.....	Duct Mounted CO2 Sensor.....	EAC180A* - EAC300A* with economizer
BAYPALT001A.....	Reuseable Pallet for Condenser End Unit Lifting.....	All Foundation 15-25 Ton Units
BAYCOSW300A.....	Drain Pan Overflow Switch .....	EAC180A* - EAC300A*
BAYSTAT300A.....	BACNet Enabled Thermostat.....	EAC180A* - EAC300A*

① Please check availability.

② See HVAC Knowledge Center for a list of compatible Carrier units.

③ FDD = Fault Detection & Diagnostics.

Information subject to change. Please confirm with current Product Data for current factory production.

# Foundation™ Packaged Cooling 15-25 Tons Heaters

**Table LPC-26-A — Foundation™ - R-410A - Field Installed Accessories**

Model Number	Power Supply	kW Rating	Nominal BTUH	No. Stages	Used With
BAYHTFA318A	208-230/3/60	13.5/18	46,100/64,400	1	EAC180A3*
BAYHTFA336A	208-230/3/60	27/36	92,200/122,900	2	EAC180A3*, EAC210A3*
BAYHTFB336A	208-230/3/60	27/36	92,200/122,900	2	EAC240A3*, EAC300A3*
BAYHTFA354A	208-230/3/60	40.5/54	138,200/184,300	2	EAC180A3*, EAC210A3*
BAYHTFB354A	208-230/3/60	40.5/54	138,200/184,300	2	EAC240A3*, EAC300A3*
BAYHTFA372A	208-230/3/60	54/72	184,300/245,700	2	EAC210A3*
BAYHTFB372A	208-230/3/60	54/72	184,300/245,700	2	EAC240A3*, EAC300A3*
BAYHTFA418A	460/3/60	18	64,000	1	EAC180A4*
BAYHTFA436A	460/3/60	36	122,900	2	EAC180A4*, EAC210A4*
BAYHTFB436A	460/3/60	36	122,900	2	EAC240A4*, EAC400A4*
BAYHTFA454A	460/3/60	54	184,300	2	EAC180A4*, EAC210A4*
BAYHTFB454A	460/3/60	54	184,300	2	EAC240A4*, EAC400A4*
BAYHTFA472A	460/3/60	72	245,700	2	EAC210A4*
BAYHTFB472A	460/3/60	72	245,700	2	EAC240A4*, EAC400A4*
BAYHTFAW18A	575/3/60	18	64,000	1	EAC180AW*
BAYHTFAW36A	575/3/60	36	122,900	2	EAC180AW*, EAC210AW*
BAYHTFBW36A	575/3/60	36	122,900	2	EAC240AW*, EACW00AW*
BAYHTFAW54A	575/3/60	54	184,300	2	EAC180AW*, EAC210AW*
BAYHTFBW54A	575/3/60	54	184,300	2	EAC240AW*, EACW00AW*
BAYHTFAW72A	575/3/60	72	245,700	2	EAC210AW*
BAYHTFBW72A	575/3/60	72	245,700	2	EAC240AW*, EACW00AW*

Information subject to change. Please confirm with current Product Data for current factory production.

## Packaged Heat Pump Convertible 3-10 Tons



Beveled Top  
Smoother Design  
Small compact cabinet  
Recessed access handles

### Standard Features:

- American Standard Heating & Air Conditioning scroll compressors on all 3-10 ton units
- ReliaTel™ Controls (See page LPC-14 for ReliaTel™ Control Information)
- Thermal Expansion Valve
- Colored and numbered wiring
- Phase Monitor, R-410A, 3 Phase Units
- Provisions for through the Base Condensate Drain Connections
- Patented Hybrid Condenser Coil for easy cleaning
- 2" throwaway filters provided on 3-10 ton units
- Liquid Line Refrigerant Drier
- Operating Charge of R-410A
- IAQ Sloped Drain Pans
- Single point power for electric Heat
- Low Ambient cooling to 0°F
- Anti-Short Cycle Timer (Standard with ReliaTel™)
- 5 - year Limited Compressor Warranty
- 1 - year Limited Parts Warranty

### Added Flexibility

- Convertible airflow
- Fork lift openings on three sides of unit
- Direct or belt drive - standard or oversized motors (Direct for 3-5 ton only)
- We don't prepackage options
- Choose options tailored to suit each job —pay only for what is needed
- Units ship with options installed —and within our standard ship cycle time

### Factory Installed Options

- Through-the-Base — Electrical
- Convenience Outlet — Powered or unpowered
- Unit Disconnect Switch
- Circuit Breaker
- Smoke Detectors — Supply, return, or both
- Condenser Coil Coating
- Hinged Access Service Panels
- Discharge Air Sensor
- Fan Fail and Clogged Filter Switches
- Condenser Coil Guard — Hail Protection Quality
- Comm 3/4 Communication Interface
- Froststat
- 2" MERV 8 filters or 2" MERV 13 filters
- Black Epoxy Pre-Coated Coils
- Crankcase Heaters
- Multi-Speed & Single Zone VAV ID Airflow
- Demand Control Ventilation
- Stainless Steel Drainpan
- Condensate Drainpan Overflow Switch

**The same American Standard Heating & Air Conditioning Quality and Reliability ... with added Flexibility!**

# Packaged Heat Pump Convertible 3-10 Tons

**Table LPH-2-A — Base Unit — Standard Efficiency — ReliaTel™ Microprocessor Controls**

Tons	Unit Ordering No.	Performance <sup>②</sup> SEER/EER	Cooling Capacity (Btuh)	Cabinet Dimensions (in.) H x D x W	Downflow Supply	Downflow Return	Shipping Weight (lbs.)	MCA*	Max <sup>①</sup> Fuse*
<b>WSC – 208-230/3/60 – Three Phase – No Heat</b>									
3	WSC036E3R0A0000	13.0	38,030	36 x 43 x 69	16 x 15.5	24 x 14	589	23.8	35
4	WSC048E3R0A0000	13.0	50,130	36 x 43 x 69	16 x 15.5	24 x 14	600	27.5	40
5	WSC060E3R0A0000	13.0	63,440	41 x 53 x 89	33 x 17.5	32.13 x 17.5	825	30.2	45
6	WSC072E3*0A0000	11.4	78,000	41 x 53 x 89	33 x 17.5	32.13 x 17.5	835	36.3	50
7½	WSC090E3*0A0000	11.1	94,000	47 x 53 x 89	33 x 17.5	32.13 x 17.5	902	38.4	60
10	WSC120E3*0A0000	11.2	126,000	51 x 63 x 100	33 x 17.5	32.25 x 17.5	1388	51.9	60
<b>WSC – 460/3/60 – Three Phase – No Heat</b>									
3	WSC036E4R0A0000	13.0	38,030	36 x 43 x 69	16 x 15.5	24 x 14	589	11.4	15
4	WSC048E4R0A0000	13.0	50,130	36 x 43 x 69	16 x 15.5	24 x 14	600	12.3	15
5	WSC060E4R0A0000	13.0	63,440	41 x 53 x 89	33 x 17.5	32.13 x 17.5	825	14.7	20
6	WSC072E4*0A0000	11.4	78,000	41 x 53 x 89	33 x 17.5	32.13 x 17.5	835	20.3	30
7½	WSC090E4*0A0000	11.1	94,000	47 x 53 x 89	33 x 17.5	32.13 x 17.5	902	19	30
10	WSC120E4*0A0000	11.2	126,000	51 x 63 x 100	33 x 17.5	32.25 x 17.5	1388	26.1	35
<b>WSC – 575/3/60 – Three Phase – No Heat</b>									
3	WSC036EWR0A0000	13.0	38,030	36 x 43 x 69	16 x 15.5	24 x 14	589	8.8	15
4	WSC048EWR0A0000	13.0	50,130	36 x 43 x 69	16 x 15.5	24 x 14	600	9.5	15
5	WSC060EWR0A0000	13.0	63,440	41 x 53 x 89	33 x 17.5	32.13 x 17.5	825	11.0	15
6	WSC072EW0A0000	11.4	78,000	41 x 53 x 89	33 x 17.5	32.13 x 17.5	835	12.4	20
7½	WSC090EW0A0000	11.1	94,000	47 x 53 x 89	33 x 17.5	32.13 x 17.5	902	14.5	20
10	WSC120EW0A0000	11.2	126,000	51 x 63 x 100	33 x 17.5	32.25 x 17.5	1388	21.1	25

\* Information subject to change. Please confirm with current Product Data/Service Facts for current factory production.

① HCAR breaker per NEC.

② SEER applies, 3-5 tons; EER applies 6-10 tons.

Light Commercial  
Packaged Heat Pumps

# Packaged Heat Pump Convertible 3-10 Tons (Model Digit Numbers)

Digit	Description	Order Number	Digit	Description	Order Number
1-8	<b>Main Assembly (see previous page)</b>		21	<b>Communications Options</b>	
9	<b>Unit Controls</b>			No Communications Interface.....	0
	ReliaTel™ Micro-processor.....	R		BACnet™ Communications Interface .....	6
10	<b>(See Heater Table below)</b>		22	<b>Refrigeration System Option</b>	
11	<b>Minor Design Sequence</b>			Standard Refrigeration System®.....	0
	First Sequence .....	A	23	<b>Refrigeration Controls</b>	
12-13	<b>Service Sequence</b>			No Refrigeration Control③.....	0
	First Sequence (Factory Assigned).....	*,*		Frostat③.....	1
14	<b>Fresh Air Selection</b>			Crankcase Heater⑩.....	2
	No Fresh Air.....	0		Frostat and Crankcase Heater⑩③.....	3
	Manual Outside Air Damper 0-50%②.....	A	24	<b>Smoke Detector</b>	
	Motorized Outside Air Damper 0-50%②.....	B		No Smoke Detector.....	0
	Economizer, Dry Bulb 0-100% without			Return Air Smoke Detector⑨.....	A
	Barometric Relief⑤.....	C		Supply Air Smoke Detector.....	B
	Economizer, Dry Bulb 0-100% with			Supply and Return Air Smoke Detectors⑨.....	C
	Barometric Relief⑤.....	D		Plenum Smoke Detector.....	D
	Economizer, Reference Enthalpy 0-100%		25	<b>System Monitoring Controls</b>	
	without Barometric Relief⑤.....	E		No Monitoring Control.....	0
	Economizer, Reference Enthalpy 0-100%			Clogged Filter Switch.....	1
	with Barometric Relief⑤.....	F		Fan Failure Switch.....	2
	Economizer, Comparative Enthalpy 0-100%			Discharge Air SensingTube.....	3
	without Barometric Relief⑤.....	G		Clogged Filter Switch and Fan Fail Switch.....	4
	Economizer, Comparative Enthalpy 0-100%			Clogged Filter Switch and Discharge Air	
	with Barometric Relief⑤.....	H		SensingTube.....	5
	Low Leak Economizer, Dry Bulb			Fan Fail Switch and Discharge Air SensingTube.....	6
	with Barometric Relief.....	K		Clogged Filter and Fan Fail Switches and	
	Low Leak Economizer, Comparative Enthalpy			Discharge Air SensingTube.....	7
	with Barometric Relief.....	M		Condensate Drain Pan Overflow Switch.....	A
	Low Leak Economizer, Reference Enthalpy			Clogged Filter Switch and Condensate Drain	
	with Barometric Relief.....	P		Pan Overflow Switch.....	B
15	<b>Supply Fan/Drive Type/Motor</b>			Fan Failure Switch and Condensate Drain	
	Standard Drive④.....	0		Pan Overflow Switch.....	C
	Oversized Motor.....	1		Discharge Air Sensing and Condensate Drain	
	Optional Belt Drive Motor.....	2		Pan Overflow Switch.....	D
	Single Zone Variable Air Volume (SZVAV).....	6		Clogged Filter Switch, Fan Failure Switch and	
	Multi-Speed Indoor Fan⑭.....	7		Condensate Drain Pan Overflow Switch.....	E
16	<b>Hinged Service Access/Filters</b>			Clogged Filter Switch, Discharge Air SensingTube	
	Standard Panels/Standard Filters.....	0		and Condensate Drain Pan Overflow Switch.....	F
	Hinged Access Panels/Standard Filters.....	A		Fan Failure Switch, Discharge Air SensingTube	
	Standard Panels/2" MERV 8 Filters.....	B		and Condensate Drain Pan Overflow Switch.....	G
	Hinged Access Panels/2" MERV 8 Filters.....	C		Clogged Filter Switch, Fan Failure Switch,	
	Standard Panels/2" MERV 13 Filters.....	D		Discharge Air Sensing and Condensate	
	Hinged Access Panels/2" MERV 13 Filters.....	E		Drain Pan Overflow Switch.....	H
17	<b>Condenser Coil Protection</b>		26	<b>System Monitoring Controls</b>	
	Standard Coil.....	0		No Monitoring Controls.....	0
	Standard Coil with Hail Guard.....	1		Demand Control Ventilation (CO <sub>2</sub> )⑤.....	A
	Black Epoxy Pre-Coated Condenser Coil.....	2		Fault Detection and Diagnostics (FDD).....	B
	Black Epoxy Pre-Coated Condenser Coil			Fault Detection and Diagnostics (FDD)	
	with Hail Guard.....	3		with Demand Control Ventilation.....	C
18	<b>Through the Base Provisions</b>		27	<b>Unit Hardware Enhancements</b>	
	No Through the Base Provisions.....	0		No Enhancements.....	0
	Through the Base Electric⑥.....	A		Stainless Steel Drain Pan.....	1
19	<b>Disconnect/Circuit Breaker (three-phase only)</b>		31	<b>Advanced Unit Controls</b>	
	No Disconnect/No Circuit Breaker.....	0		Standard Unit Controls.....	0
	Unit Mounted Non-Fused Disconnect⑥.....	1		Human Interface.....	1
	Unit Mounted Circuit Breaker⑥.....	2			
20	<b>Convenience Outlet</b>				
	No Convenience Outlet.....	0			
	Unpowered Convenience Outlet.....	A			
	Powered Convenience Outlet (three-phase only)⑦.....	B			

Light Commercial  
Packaged Heat Pumps

① Available on 3-5 ton models.  
 ② Manual outside air damper will ship factory supplied within the unit, but must be field installed.  
 ③ High pressure control is standard on all units.  
 ④ Multispeed direct drive standard on single-phase products. Belt drive standard on three-phase 3-7½ ton. Variable speed direct drive standard on 10 ton.  
 ⑤ Economizer with Barometric Relief is for downflow configured units only. Order Economizer without Barometric Relief for horizontal configuration. Barometric Relief for horizontal configured units must be ordered as field installed accessory.  
 ⑥ Through the base electric required when ordering disconnect/circuit breaker options.  
 ⑦ Requires use of Disconnect or Circuit Breaker.  
 ⑧ Standard metering devices are TXVs.  
 ⑨ The return air smoke detector may not fit up or work properly on the Precedent units when used in conjunction with 3rd party accessories such as bolt on heat wheels, economizers and power exhaust. Do not order the return air smoke detectors when using this type of accessory.  
 ⑩ Requires hinged access panels.  
 ⑪ Crankcase heaters are only available as option on WSC036E, WSC048E1, & WSC060E1. CCH are standard on all other units.  
 ⑫ Motorized outside air damper is not available on Multi-Speed or SZVAV (Single Zone Variable Air Volume) products.  
 ⑬ Frostat standard on Multi-speed and SZVAV (Single Zone Variable Air Volume) products.  
 ⑭ Multi-speed indoor fan only available on 10 ton products.  
 ⑮ Demand Control Ventilation Option includes wiring only. The CO<sub>2</sub> sensor is a field-installed only option.



# Packaged Heat Pump Convertible 3-10 Tons (Model Digit Numbers)

**Heaters (Digit 10)**

kW Rating	Digit	Nominal BTUH	No. Stages	Used With	kW Rating	Digit	Nominal BTUH	No. Stages	Used With																																																		
<b>208/240/1/60</b>					<b>460/3/60</b>																																																						
3.8/5.0	(A)	12,800/17,100	1	WSC036-060E1	6.0	(B)	20,500	1	WSC036-060E4																																																		
7.5/10.0	(D)	25,600/34,100	2	WSC036-060E1	12.0	(E)	41,000	2	WSC036-060E4																																																		
10.4/13.8	(F)	35,300/47,100	2	WSC036-060E1	17.4	(G)	59,400	2	WSC036-060E4																																																		
13.2/17.6	(G)	45,100/60,100	2	WSC048-060E1	23.0	(J)	78,500	2	WSC060E4																																																		
<b>208/240/3/60</b>					<b>575/3/60</b>																																																						
4.5/6.0	(B)	13,400/20,500	1	WSC036-060E3	18.0	(G)	61,400	1	W*C072-120E4																																																		
9.0/12.0	(E)	30,800/59,400	2	WSC036-060E3	27.0	(K)	92,100	2	W*C072-120E4																																																		
13.1/17.4	(G)	44,600/59,400	2	WSC036-060E3	36.0	(N)	122,900	2	W*C072-120E4																																																		
17.3/23.0	(J)	58,900/78,500	2	WSC060E3	54.0	(P)	184,300	2	W*C120E4																																																		
6.75/9.0	(C)	23,000/30,700	1	W*C072-090E3	<table border="1"> <tr> <td colspan="5"><b>575/3/60</b></td> </tr> <tr> <td>6.0</td> <td>(B)</td> <td>20,500</td> <td>1</td> <td>WSC036-060EW</td> </tr> <tr> <td>12.0</td> <td>(E)</td> <td>41,000</td> <td>2</td> <td>WSC036-060EW</td> </tr> <tr> <td>17.4</td> <td>(G)</td> <td>59,400</td> <td>2</td> <td>WSC036-060EW</td> </tr> <tr> <td>23.0</td> <td>(J)</td> <td>78,500</td> <td>2</td> <td>WSC060EW</td> </tr> <tr> <td>9.0</td> <td>(C)</td> <td>30,700</td> <td>1</td> <td>W*C072-090EW</td> </tr> <tr> <td>18.0</td> <td>(G)</td> <td>61,400</td> <td>1</td> <td>W*C072-120EW</td> </tr> <tr> <td>27.0</td> <td>(K)</td> <td>92,100</td> <td>2</td> <td>W*C072-120EW</td> </tr> <tr> <td>36.0</td> <td>(N)</td> <td>122,900</td> <td>2</td> <td>W*C072-120EW</td> </tr> <tr> <td>54.0</td> <td>(P)</td> <td>184,300</td> <td>2</td> <td>W*C120EW</td> </tr> </table>					<b>575/3/60</b>					6.0	(B)	20,500	1	WSC036-060EW	12.0	(E)	41,000	2	WSC036-060EW	17.4	(G)	59,400	2	WSC036-060EW	23.0	(J)	78,500	2	WSC060EW	9.0	(C)	30,700	1	W*C072-090EW	18.0	(G)	61,400	1	W*C072-120EW	27.0	(K)	92,100	2	W*C072-120EW	36.0	(N)	122,900	2	W*C072-120EW	54.0	(P)	184,300	2	W*C120EW
<b>575/3/60</b>																																																											
6.0	(B)	20,500	1	WSC036-060EW																																																							
12.0	(E)	41,000	2	WSC036-060EW																																																							
17.4	(G)	59,400	2	WSC036-060EW																																																							
23.0	(J)	78,500	2	WSC060EW																																																							
9.0	(C)	30,700	1	W*C072-090EW																																																							
18.0	(G)	61,400	1	W*C072-120EW																																																							
27.0	(K)	92,100	2	W*C072-120EW																																																							
36.0	(N)	122,900	2	W*C072-120EW																																																							
54.0	(P)	184,300	2	W*C120EW																																																							
13.5/18.0	(G)	46,100/61,400	1	W*C072-120E3																																																							
20.3/27.0	(K)	69,000/92,100	2	W*C072-120E3																																																							
27.0/36.0	(N)	92,200/122,900	2	W*C072-120E3																																																							
40.5/54.0	(P)	138,200/184,300	2	W*C120E3																																																							

Light Commercial  
Packaged Heat Pumps

# Packaged Heat Pump Convertible 3-5 Tons, Electric Heaters

**Table LPH-5-A — Accessory Electric Heaters – Unit with heater is single circuit / single point power entry**

Model Number	Power Supply	kW Rating	Nominal BTUH	No. Stages	Used With
BAYHTRE105A	208-230/1/60	3.8/5.0	12,900/13,400	1	WSC036-048E1
BAYHTRE110A	208-230/1/60	7.5/10.0	25,600/34,000	2	WSC036-048E1
BAYHTRE114A	208-230/1/60	10.4/13.8	35,000/47,100	2	WSC036-048E1
BAYHTRE118A	208-230/1/60	13.2/17.6	45,100/60,100	2	WSC048E1
BAYHTRE306C	208-230/3/60	4.5/6.0	13,400/20,500	1	WSC036-048E3
BAYHTRE312C	208-230/3/60	9.0/12.0	30,800/41,000	2	WSC036-048E3
BAYHTRE318C	208-230/3/60	13.0/17.4	44,600/59,400	2	WSC036-048E3
BAYHTRE406C	460/3/60	6.0	20,500	1	WSC036-048E4
BAYHTRE412C	460/3/60	12.0	41,000	2	WSC036-048E4
BAYHTRE418C	460/3/60	17.4	59,400	2	WSC036-048E4
BAYHTREW06C	575/3/60	6.0	20,500	1	WSC036-048EW
BAYHTREW12C	575/3/60	12.0	41,000	2	WSC036-048EW
BAYHTREW18C	575/3/60	17.4	59,400	2	WSC036-048EW

**Table LPH-5-B — Accessory Electric Heaters – Unit with heater is single circuit / single point power entry (5 Ton Only)**

Model Number	Power Supply	kW Rating	Nominal BTUH	No. Stages	Used With
BAYHTRX105A	208-230/1/60	3.8/5.0	12,900/13,400	1	WSC060E1
BAYHTRX110A	208-230/1/60	7.5/10.0	25,600/34,000	2	WSC060E1
BAYHTRX114A	208-230/1/60	10.4/13.8	35,000/47,100	2	WSC060E1
BAYHTRX118A	208-230/1/60	13.2/17.6	45,100/60,100	2	WSC060E1
BAYHTRX306B	208-230/3/60	4.5/6.0	13,400/20,500	1	WSC060E3
BAYHTRX312B	208-230/3/60	9.0/12.0	30,800/41,000	2	WSC060E3
BAYHTRX318B	208-230/3/60	13.0/17.4	44,600/59,400	2	WSC060E3
BAYHTRX323B	208-230/3/60	17.3/23.0	59,000/78,500	2	WSC060E3
BAYHTRX406B	460/3/60	6.0	20,500	1	WSC060E4
BAYHTRX412B	460/3/60	12.0	41,000	2	WSC060E4
BAYHTRX418B	460/3/60	18.0	59,400	2	WSC060E4
BAYHTRX423B	460/3/60	23.0	78,500	2	WSC060E4
BAYHTRXW06B	575/3/60	6.0	20,500	1	WSC060EW
BAYHTRXW12B	575/3/60	12.0	41,000	2	WSC060EW
BAYHTRXW18B	575/3/60	18.0	59,400	2	WSC060EW
BAYHTRXW23B	575/3/60	23.0	78,500	2	WSC060EW

# Packaged Heat Pump Convertible 6-10 Tons, Electric Heaters and Zone Sensors

**Table LPH-6-A — Accessory Electric Heaters – Unit with heater is single circuit / single point power entry**

Model Number	Power Supply	kW Rating	Nominal BTUH	No. Stages	Used With
BAYHTRW309A	208-230/3/60	6.8/9.0	23,000/30,700	1	WSC072E3
BAYHTRW318A	208-230/3/60	13.5/18.0	46,100/61,400	1	WSC072E3
BAYHTRW327A	208-230/3/60	20.3/27.0	69,000/92,100	2	WSC072E3
BAYHTRW336A	208-230/3/60	27.0/36.0	92,100/122,900	2	WSC072E3
BAYHTRU309A	208-230/3/60	6.8/9.0	23,000/30,700	1	WSC090E3
BAYHTRU318A	208-230/3/60	13.5/18.0	46,100/61,400	1	WSC090E3
BAYHTRU327A	208-230/3/60	20.3/27.0	69,000/92,100	2	WSC090E3
BAYHTRU336A	208-230/3/60	27.0/36.0	92,100/122,900	2	WSC090E3
BAYHTRB318A	208-230/3/60	13.5/18.0	46,100/61,400	1	WSC120E3
BAYHTRB327A	208-230/3/60	20.3/27.0	69,000/92,100	2	WSC120E3
BAYHTRB336A	208-230/3/60	27.0/36.0	92,100/122,900	2	WSC120E3
BAYHTRB354A	208-230/3/60	40.6/54.0	138,000/184,300	2	WSC120E
BAYHTRW409A	460/3/60	9.0	30,700	1	WSC072E4
BAYHTRW418A	460/3/60	18.0	61,400	1	WSC072E4
BAYHTRW427A	460/3/60	27.0	92,100	2	WSC072E4
BAYHTRW436A	460/3/60	36.0	122,900	2	WSC072E4
BAYHTRU409A	460/3/60	9.0	30,700	1	WSC090E4
BAYHTRU418A	460/3/60	18.0	61,400	1	WSC090E4
BAYHTRU427A	460/3/60	27.0	92,100	2	WSC090E4
BAYHTRU436A	460/3/60	36.0	122,900	2	WSC090E4
BAYHTRB418A	460/3/60	18.0	61,400	1	WSC120E4
BAYHTRB427A	460/3/60	27.0	92,100	2	WSC120E4
BAYHTRB436A	460/3/60	36.0	122,900	2	WSC120E4
BAYHTRB454A	460/3/60	54.0	184,300	2	WSC120E4
BAYHTRWW18A	575/3/60	18.0	61,400	1	WSC072EW
BAYHTRWW27A	575/3/60	27.0	92,100	2	WSC072EW
BAYHTRWW36A	575/3/60	36.0	122,900	2	WSC072EW
BAYHTRUW18A	575/3/60	18.0	61,400	1	WSC090EW
BAYHTRUW27A	575/3/60	27.0	92,100	2	WSC090EW
BAYHTRUW36A	575/3/60	36.0	122,900	2	WSC090EW
BAYHTRBW18A	575/3/60	18.0	61,400	1	WSC120EW
BAYHTRBW36A	575/3/60	36.0	122,900	2	WSC120EW
BAYHTRBW54A	575/3/60	54.0	184,300	2	WSC120EW

**Table LPH-6-B — Zone Sensors for ReliaTel™ Controlled Units**

Model Number	Description	Used With
BAYMTPL103A	Retrofit Wall Cover Plate Kit 7.25" x 6.0"	ASYSTAT777A
ASYSTAT107A	Single Setpoint Manual Changeover	WSC036-120E
ASYSTAT109A	Dual Setpoint Manual or Auto Changeover	WSC036-120E
ASYSTAT111A	Remote Room Sensor	ASYSTAT777A
ASYSTAT777A	Programmable Night Setback w/System Function Lights (Vertical Style)	WSC036-120E

# Packaged Heat Pump Convertible 3-10 Tons Accessories

**Table LPH-7-A — Accessories**

Model Number	Description	Used With
BAYABRD001C <sup>④</sup>	ReliaTel™ Options Module	All WSC036-120E, See Note <sup>④</sup>
BAYBARM010A <sup>②</sup>	Barometric Relief	WSC036-048E
BAYBARM011A <sup>②</sup>	Barometric Relief	WSC060-120E
BAYBCIR001A	Bacnet™ Communication Interface	ReliaTel™ Controller (BCI-R)
BAYCCHT010B	Crankcase Heater	WSC036E1, E3, WSC048E1
BAYCCHT011B	Crankcase Heater	WSC036E4, EW
BAYCCHT017A	Crankcase Heater	WSC060E1
ASYSTAT712B	CO <sub>2</sub> Sensor Kit, Wall Mounted	All WSC036-120E
ASYSTAT714B	CO <sub>2</sub> Sensor Kit, Duct Mounted	All WSC036-120E
BAYCURB042A <sup>③</sup>	Roof Curb	WSC036-048E
BAYCURB043A <sup>③</sup>	Roof Curb	WSC060-090E
BAYCURB044A <sup>③</sup>	Roof Curb	WSC120E
BAYDFPS003B <sup>④</sup>	Clogged Filter Switch (w/Standard & MERV 8 Filter)	All WSC036-120E
BAYDFPS014A <sup>④</sup>	Clogged Filter Switch (MERV 13 Filter)	All WSC036-120E
BAYDFPS004A <sup>④</sup>	Fan Failure Switch	All WSC036-120E
BAYDMPR053B <sup>⑥</sup>	0-50% Manual Outside Air Damper	WSC036-048E
BAYDMPR056B <sup>⑥</sup>	0-50% Manual Outside Air Damper	WSC060-120E
BAYDMPR051A	0-50% Motorized Outside Air Damper	WSC036-048E
BAYDMPR054A	0-50% Motorized Outside Air Damper	WSC060-120E
BAYECON085A	0-100% Economizer without Barometric Relief	WSC036-048E
BAYECON087A	0-100% Economizer without Barometric Relief	WSC060-120E
BAYECON704A	Downflow Low Leak Economizer	WSC060E(3/4/W)R, WSC072-120E*R (ReliaTel™)
BAYECON705B	Downflow Low Leak Economizer	WSC060EDR, WSC036E-048E*R (ReliaTel™)
BAYENTH005A <sup>①</sup>	Reference Enthalpy Kit	BAYECON085A, 087A
BAYENTH006A <sup>①</sup>	Comparative Enthalpy Kit	BAYECON085A, 087A
BAYFRST003A <sup>⑤</sup>	High Temperature Stat	All WSC036-120E
BAYGARD037B	Condenser Coil Hail Guard	WSC036-048E
BAYGARD040A	Condenser Coil Hail Guard	WSC060E-072E
BAYGARD041A	Condenser Coil Hail Guard	WSC090E
BAYGARD070A	Condenser Coil Hail Guard	WSC120E

<sup>①</sup> Kits contain all necessary parts to achieve desired level of enthalpy control.

<sup>②</sup> Barometric Relief accessory installs in ductwork for horizontal configuration. For downflow configuration, installs on the unit's horizontal return duct. Panel see Installer's Guide for complete instructions.

<sup>③</sup> Lynn Haven manufacturing has a no return policy for this roof curb.

<sup>④</sup> BAYABRD001C is required when ordering field installed accessories Clogged Filter Switch (BAYDFPS003A), Fan Fail Switch (BAYDFPS004A), Discharge Air Sensing Kit (BAYTUBE005A or BAYTUBE007A) or Evaporator Defrost Control (Frostat) (BAYLOAM020B) Ventilation Override Kit (BAYVNOR001B) unless the following options are factory installed: Frostat, Smoke Detector, Clogged Filter Switch, Fan Failure Switch, Discharge Air Sensing Kit. These factory installed options include the ReliaTel™ Options Module.

<sup>⑤</sup> Cannot be used in conjunction with factory installed smoke detector.

<sup>⑥</sup> The manual outside air damper will ship factory supplied within the unit, but must be field installed.

# Packaged Heat Pump Convertible 3-10 Tons Accessories

**Table LPH-8-A — Accessories**

Model Number	Description	Used With
BAYHSMT403A	2 HP Belt Drive Oversized Motor	WSC072E3, E4
BAYHSMT404A	2 HP Belt Drive Oversized Motor	WSC072EW
BAYHSMT400A	3 HP Belt Drive Oversized Motor	WSC090E3, E4
BAYHSMT401A	3 HP Belt Drive Oversized Motor	WSC090EW
BAYLSDR009A	Low Static Drive	WSC090E*
BAYKSKT255B	Start Kit	WSC036-060E1
BAYPWRX070A	Power Exhaust (208-230/3)	WSC036-060E3
BAYPWRX071A	Power Exhaust (460/3)	WSC036-060E4
BAYPWRX072A	Power Exhaust (575/3)	WSC036-060EW
BAYPWRX026A <sup>⑥</sup>	Power Exhaust (208-230/3)	WSC072-120E3
BAYPWRX027A <sup>⑥</sup>	Power Exhaust (460/3)	WSC072-120E4
BAYPWRX028A <sup>⑥</sup>	Power Exhaust (575/3)	WSC072-120EW
BAYQACB009A <sup>②③</sup>	Quick Adapt Roof Curb	WSC036-048E
BAYQACB010A <sup>②③</sup>	Quick Adapt Roof Curb	WSC036-048E
BAYQACB011A <sup>②⑧</sup>	Quick Adapt Roof Curb	WSC060-090E
BAYQACB012A <sup>②⑧</sup>	Quick Adapt Roof Curb	WSC060-090E
BAYQACB013A <sup>②⑧</sup>	Quick Adapt Roof Curb	WSC060-090E
BAYQACB111A <sup>②③</sup>	Quick Adapt Roof Curb	WSC120E
BAYQACB112A <sup>②③</sup>	Quick Adapt Roof Curb	WSC120E
BAYQACB113A <sup>②③</sup>	Quick Adapt Roof Curb	WSC120E
BAYRTEM001A <sup>⑧</sup>	Fully Featured ReliaTel™ Economizer Logic Model	WSE036-120E
BAYSENS250A <sup>③⑩</sup>	CO <sub>2</sub> Duct Mounted, Sensor Only	WSC036-120E (ReliaTel™)
BAYSENS251A <sup>③⑩</sup>	CO <sub>2</sub> Wall Mounted, Sensor Only	WSC036-120E (ReliaTel™)
BAYSERV001A	Selective Resistance Service Tester	All WSC036-120E
BAYSTAT023	Remote Potentiometer	All WSC036-120E
BAYTUBE005A <sup>①④</sup>	Discharge Air Sensing Kit	WSC036-048E
BAYTUBE007A <sup>①④</sup>	Discharge Air Sensing Kit	WSC060-090E
BAYTUBE403A <sup>①④</sup>	Discharge Air Sensing Kit	WSC120E
BAYVNOR001B <sup>⑨④</sup>	Ventilation Override Kit w/ReliaTel™ options module	All WSC036-120E

- ① Used for true discharge air sensing in both heating and cooling. Required for supply air tempering.
- ② Lynn Haven manufacturing has a no return policy for this roof curb.
- ③ BAYQACB009A adapts WCD models BAYCURB021A roof curb to accept WSC036-048 units. BAYQACB010A adapts WCD models BAYCURB022A roof curb to accept WSC036-048 units. BAYQACB111A adapts WCD models BAYCURB022 roof curb to accept WSC120E. BAYQACB112A adapts WCD models BAYCURB025 roof curb to accept WSC120E. BAYQACB113A adapts WCD models BAYCURB026 roof curb to accept WSC120E.
- ④ BAYABRD001C is required when ordering field installed accessories Clogged Filter Switch (BAYDFPS003A), Fan Fail Switch (BAYDFPS004A), Discharge Air Sensing Kit (BAYTUBE005A or BAYTUBE007A) or Evaporator Defrost Control (Frostat) (BAYLOAM020B) Ventilation Override Kit (BAYVNOR001B) unless the following options are factory installed: Frostat, Smoke Detector, Clogged Filter Switch, Fan Failure Switch, Discharge Air Sensing Kit. These factory installed options include the ReliaTel™ Options Module.
- ⑤ Power Exhaust cannot be used with Barometric Relief. Order Economizer without Barometric Relief.
- ⑥ BAYQACB012A adapts WCD models BAYCURB025 roof curb to accept WSC072-120 units. BAYQACB011A adapts WCD models BAYCURB022B roof curb to accept WSC072-120 units.
- ⑦ BAYQACB013A adapts WCD models BAYCURB026 roof curb to accept WSC060-090E. Field installed accessory. Requires an economizer.
- ⑧ If any version of comparative or reference enthalpy is ordered, BAYRTEM001A does not need to be ordered.

# Packaged Heat Pump with ReliaTel™ Controls 12½-20 Tons

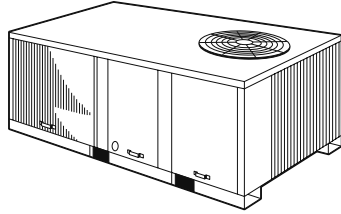

**12½ – 20 Ton WSD—Downflow**  
**12½ – 20 Ton WSH—Horizontal**

- EER up to 10.6
- ReliaTel™ processor control features are listed on page LPC-14
- Built-in anti-short cycle, time-delay relay and minimum on time controls
- 2" filters for 12½ - 20 ton units
- Liquid line drier
- Built-in fork lift holes
- Operating charge of R-410A
- Quick-Access service panels slide in and out
- Scroll compressors
- Dedicated horizontal and downflow designs
- Single-side access
- Single point power for electric heat
- Complete line of optional electric heaters
- Internally enhanced coil tubing
- Low ambient to 0°F standard
- Colored and numbered wiring
- Common cabinet and accessories Cooling only and Gas/Electric Heat models
- Quick-adjust idler arm pulley
- **5-year limited compressor warranty (12½ – 20 tons)**

**Table LPH-9-A — Standard — ReliaTel™ Units (R-410A)**

Tons	Unit Model No.	Power Supply Volts/Phase/Hz	Performance EER (10)	Cooling Capacity (Btuh)	Dimensions (in.) H x W x L	Shipping Weight (lbs.)	MCA <sup>⑤</sup>	Max Fuse Size or <sup>④</sup> Max Circuit Breaker	Downflow Roofcurb	
12½	WS*150E3R0A0000	208-230/3/60	10.6	148,000	54 x 85 <sup>5</sup> / <sub>16</sub> x 122 <sup>5</sup> / <sub>16</sub>	2340	68	80	BAYCURB027B	
15	WS*180E3R0A0000	208-230/3/60	10.6	177,000	54 x 85 <sup>5</sup> / <sub>16</sub> x 122 <sup>5</sup> / <sub>16</sub>	2435	74	90	BAYCURB027B	
20	WS*240E3R0A0000	208-230/3/60	9.7	249,000	64 <sup>1</sup> / <sub>8</sub> x 85 <sup>5</sup> / <sub>16</sub> x 122 <sup>5</sup> / <sub>16</sub>	2566	116	150	BAYCURB027B	
12½	WS*150E4R0A0000	460/3/60	10.6	148,000	54 x 85 <sup>5</sup> / <sub>16</sub> x 122 <sup>5</sup> / <sub>16</sub>	2340	32	40	BAYCURB027B	
15	WS*180E4R0A0000	460/3/60	10.6	177,000	54 x 85 <sup>5</sup> / <sub>16</sub> x 122 <sup>5</sup> / <sub>16</sub>	2435	36	45	BAYCURB027B	
20	WS*240E4R0A0000	460/3/60	9.7	249,000	64 <sup>1</sup> / <sub>8</sub> x 85 <sup>5</sup> / <sub>16</sub> x 122 <sup>5</sup> / <sub>16</sub>	2566	53	60	BAYCURB027B	
12½	WS*150EWR0A0000	575/3/60	10.6	148,000	54 x 85 <sup>5</sup> / <sub>16</sub> x 122 <sup>5</sup> / <sub>16</sub>	2340	25	30	BAYCURB027B	
15	WS*180EWR0A0000	575/3/60	10.6	177,000	54 x 85 <sup>5</sup> / <sub>16</sub> x 122 <sup>5</sup> / <sub>16</sub>	2435	30	35	BAYCURB027B	
20	WS*240EWR0A0000	575/3/60	9.7	249,000	64 <sup>1</sup> / <sub>8</sub> x 85 <sup>5</sup> / <sub>16</sub> x 122 <sup>5</sup> / <sub>16</sub>	2566	45	60	BAYCURB027B	
Tons	Supply Downflow W x L <sup>①②</sup>	Return Downflow W x L <sup>①②</sup>	Supply Horizontal H x W <sup>①②</sup>	Return Horizontal H x W <sup>①②</sup>	Curb Size H x W x L <sup>②③</sup>	Roof Opening W x L <sup>①②</sup>				
20	28 <sup>9</sup> / <sub>16</sub> x 69 <sup>1</sup> / <sub>2</sub>	22 <sup>1</sup> / <sub>4</sub> x 77	46 <sup>7</sup> / <sub>16</sub> x 26 <sup>1</sup> / <sub>2</sub>	46 <sup>7</sup> / <sub>16</sub> x 27 <sup>9</sup> / <sub>16</sub>	14 <sup>1</sup> / <sub>16</sub> x 81 x 117 <sup>9</sup> / <sub>16</sub>	76 <sup>1</sup> / <sub>2</sub> x 81				

**Table LPH-9-B — Standard — ReliaTel™ Units (R-410A) — Multi-Speed Indoor Fan**

Tons	Unit Model No.	Power Supply Volts/Phase/Hz	Performance EER (10)	Cooling Capacity (Btuh)	Dimensions (in.) H x W x L	Shipping Weight (lbs.)	MCA <sup>⑤</sup>	Max Fuse Size or <sup>④</sup> Max Circuit Breaker	Downflow Roofcurb
12½	WS*150E3R0A1B8B	208-230/3/60	10.6	148,000	54 x 85 <sup>5</sup> / <sub>16</sub> x 122 <sup>5</sup> / <sub>16</sub>	2365	68	80	BAYCURB027B
15	WS*180E3R0A1B8B	208-230/3/60	10.6	177,000	54 x 85 <sup>5</sup> / <sub>16</sub> x 122 <sup>5</sup> / <sub>16</sub>	2460	74	90	BAYCURB027B
20	WS*240E3R0A1B8B	208-230/3/60	9.7	249,000	64 <sup>1</sup> / <sub>8</sub> x 85 <sup>5</sup> / <sub>16</sub> x 122 <sup>5</sup> / <sub>16</sub>	2591	116	150	BAYCURB027B
12½	WS*150E4R0A1B8B	460/3/60	10.6	148,000	54 x 85 <sup>5</sup> / <sub>16</sub> x 122 <sup>5</sup> / <sub>16</sub>	2365	32	40	BAYCURB027B
15	WS*180E4R0A1B8B	460/3/60	10.6	177,000	54 x 85 <sup>5</sup> / <sub>16</sub> x 122 <sup>5</sup> / <sub>16</sub>	2460	36	45	BAYCURB027B
20	WS*240E4R0A1B8B	460/3/60	9.7	249,000	64 <sup>1</sup> / <sub>8</sub> x 85 <sup>5</sup> / <sub>16</sub> x 122 <sup>5</sup> / <sub>16</sub>	2591	53	60	BAYCURB027B
12½	WS*150EWR0A1B8B	575/3/60	10.6	148,000	54 x 85 <sup>5</sup> / <sub>16</sub> x 122 <sup>5</sup> / <sub>16</sub>	2365	25	30	BAYCURB027B
15	WS*180EWR0A1B8B	575/3/60	10.6	177,000	54 x 85 <sup>5</sup> / <sub>16</sub> x 122 <sup>5</sup> / <sub>16</sub>	2460	30	35	BAYCURB027B
20	WS*240EWR0A1B8B	575/3/60	9.7	249,000	64 <sup>1</sup> / <sub>8</sub> x 85 <sup>5</sup> / <sub>16</sub> x 122 <sup>5</sup> / <sub>16</sub>	2591	45	60	BAYCURB027B

① Dimensions are in inches. See Outline Dimensions.

② Interior Dimension.

③ Measurement Includes Curb Flange.

④ HACR type circuit breaker per NEC.

⑤ Information subject to change. Please confirm with current Product Data/Service Facts for current factory production.

\* Digit 3 - H = Horizontal or D = Downflow.

# Packaged Heat Pump with ReliaTel™ Controls 12½-25 Tons (Model Digit Numbers)

Light Commercial Packaged Heat Pumps

Digit	Description	Order Number	Digit	Description	Order Number
1	<b>Unit Type</b>		19	<b>Disconnect Switch/Circuit Breaker</b>	
	Packaged Cooling, Electric Heat.....	W		No Disconnect/circuit break.....	0
2	<b>Efficiency</b>			Unit Mounted Non-Fused Disconnect Switch.....	1
	Standard Efficiency.....	S		Unit Mounted Circuit Breaker.....	2
3	<b>Airflow Configuration</b>		20	<b>Convenience Outlet Option</b>	
	Downflow.....	D		Without Convenience Outlet.....	0
	Horizontal.....	H		Unpowered Convenience Outlet.....	A
4-6	<b>Nominal Gross Cooling Capacity (MBh)</b>			Powered Convenience Outlet.....	B
	12½ Tons.....	150	21	<b>Communications Options</b>	
	15 Tons.....	180		Without Communications Options.....	0
	17½ Tons.....	210		Building Automation Control Network	
	20 Tons.....	240		Communications Interface.....	6
7	<b>Major Design Sequence</b>		22	<b>Refrigeration System Option</b>	
	R-410A Refrigerant.....	E		Standard refrigeration system.....	0
8	<b>Voltage Selection</b>		23	<b>Refrigeration Controls</b>	
	208-230/60/3.....	3		Without Refrigeration Controls.....	0
	460/60/3.....	4		Frostat.....	1
	575/60/3.....	W	24	<b>Smoke Detector</b>	
9	<b>Unit Controls</b>			Without Smoke Detector.....	0
	ReliaTel™.....	R		Return Air Smoke Detector.....	A
10	<b>Heating Capacity</b>			Supply Air Smoke Detector.....	B
	No Heat.....	0		Return/Supply Air Smoke Detector.....	C
	18 kW Electric Heat.....	G		Plenum Smoke Detector.....	D
	36 kW Electric Heat.....	N	25	<b>System Monitoring Controls</b>	
	54 kW Electric Heat.....	P		No Monitoring Controls.....	0
	72 kW Electric Heat.....	R		Clogged Filter Switch.....	1
11	<b>Minor Design Sequence</b>			Fan Failure Switch.....	2
12-13	<b>Service Sequence</b>			Discharge Air Sensing.....	3
14	<b>Fresh Air Selection</b>			Clogged Filter Switch and Fan Failure.....	4
	No Fresh Air.....	0		Clogged Filter Switch and Discharge Air Sensing.....	5
	Manual Damper.....	A		Fan Failure Switch and Discharge Air Sensing.....	6
	Motorized Damper.....	B		Clogged Filter Switch, Fan Failure Switch and	
	Econ Dry Bulb w/Barometric Relief.....	D		Discharge Air Sensing.....	7
	Econ Reference Enthalpy w/Barometric Relief.....	F		Condensate Drain Pan Overflow Switch.....	A
	Econ Comparative Enthalpy w/Barometric Relief.....	H		Clogged Filter Switch and Condensate Drain	
	Low Leak Economizer, Dry Bulb			Pan Overflow Switch.....	B
	with Barometric Relief.....	K		Fan Failure Switch and Condensate Drain	
	Low Leak Economizer, Comparative Enthalpy			Pan Overflow Switch.....	C
	with Barometric Relief.....	M		Discharge Air Sensing and Condensate	
	Low Leak Economizer, Reference Enthalpy			Drain Pan Overflow Switch.....	D
	with Barometric Relief.....	P		Clogged Filter Switch, Fan Failure Switch and	
15	<b>Supply Fan/Drive Type/Motor</b>			Condensate Drain Pan Overflow Switch.....	E
	Standard Motor.....	0		Clogged Filter Switch, Discharge Air Sensing	
	Oversized Motor.....	1		Tube and Condensate Drain Pan Overflow Switch....	F
	High Efficiency Motor.....	3		Fan Failure Switch, Discharge Air Sensing Tube and	
	Single Zone Variable Air Volume Standard Motor.....	6		Condensate Drain Pan Overflow Switch.....	G
	Multi-Speed Standard Motor.....	7		Clogged Filter Switch, Fan Failure Switch, Discharge	
	Single Zone Variable Air Volume Oversized Motor.....	8		Air Sensing and Condensate Drain Pan Overflow	
	Multi-Speed Oversized Motor.....	9		Switch.....	H
	Single Zone Variable Air Volume Standard		26	<b>System Monitoring Controls</b>	
	Motor w/Shaft Ground Ring.....	A		No Monitoring Controls.....	0
	Multi-Speed Standard Motor w/Shaft Ground Ring.....	B		Demand Control Ventilation (CO <sub>2</sub> )Ⓞ.....	A
	Single Zone Variable Air Volume Oversized			Fault Detection and Diagnostics (FDD).....	B
	Motor w/Shaft Ground Ring.....	C		Fault Detection and Diagnostics (FDD)	
	Multi-Speed Oversized Motor w/Shaft Ground Ring.....	D		with Demand Control Ventilation.....	C
16	<b>Hinged Service Access / Filters</b>		27	<b>Unit Hardware Enhancements</b>	
	Standard Panels/Standard Filters.....	0		No Enhancements.....	0
	Hinged Access/Standard Filters.....	A		Stainless Steel Drain Pan.....	1
	Standard Panels/2" MERV 8 Filters.....	B	28	<b>Short Circuit Current Rating (SCCR)</b>	
	Hinged Access/2" MERV 8 Filters.....	C		Standard SCCR.....	0
	Standard Panels/MERV 13 Filters.....	D		65 kA SCCR.....	A
	Hinged Access/MERV 13 Filters.....	E	31	<b>Advanced Unit Controls</b>	
17	<b>Condenser Coil Protection</b>			Standard Unit Controls.....	0
	Standard Coil.....	0		Human Interface.....	1
	Standard Coil With Hail Guard.....	1			
	Black Epoxy Pre-Coated Coil.....	2			
	Black Epoxy Pre-Coated Coil with Hail Guard.....	3			
18	<b>Through The Base Provisions</b>				
	No Through The Base Provisions.....	0			
	Through The Base Electric.....	A			
	Through The Base Access.....	D			

**Note:** Most Factory Installed Options available for Downflow Air Discharge units only. Please verify with ordering system for availability.

Ⓞ Demand Control Ventilation Option includes wiring only. The CO<sub>2</sub> sensor is a field-installed only option.

# Packaged Heat Pump with ReliaTel™ Controls 12½-20 Tons Zone Sensors

**Table LPH-11-A — Zone Sensors**

Model Number	Description	Used With
ASYSTAT107A	Single Setpoint Manual Changeover	WC*150-240
ASYSTAT109A	Dual Setpoint Manual or Automatic Changeover	WC*150-240
ASYSTAT111A	Remote Room Sensor	ASYSTAT777A
ASYSTAT777A	Programmable Night Setback	WC*150-240
BAYMTPL110A	Retrofit Wall Cover Plate Kit 7.25" x 6.0"	ASYSTAT777A



# Packaged Heat Pump with ReliaTel™ Controls 12½-20 Tons Accessories

Light Commercial Packaged Heat Pumps

**Table LPH-12-A — Field Installed Accessories**

Model Number	Description	Used With
BAYABRD002B <sup>⑥</sup>	ReliaTel™ Options Module	All Voyager Heat Pumps
BAYBCIR001A	Bacnet™ Communication Interface	ReliaTel™ Controller (BCI-R)
BAYCO2K002B <sup>⑦</sup>	CO <sub>2</sub> Sensor Wall Mounted	All Voyager Heat Pumps w/Economizers
BAYCO2K004B <sup>⑦</sup>	CO <sub>2</sub> Sensor Duct Mounted	All Voyager Heat Pumps w/Economizers
BAYCURB027B <sup>③④</sup>	Downflow Only Roof Curb	WSD150E-240E
BAYDFPS005A <sup>⑤⑥</sup>	Clogged Filter Switch (MERV 7)	WS*150E-240E
BAYDFPS006A <sup>⑤⑥</sup>	Fan Failure Switch	WS*150E-240E
BAYDFPS013A	Clogged Filter Switch (MERV 13)	WS*150E-240E
BAYDMPR029C	0-25% Manual Outside Air Damper	All Packaged Rooftops 12½-20 Tons
BAYDMPR058A	0-50% Motorized Outside Air Damper	WS*150E-240E
BAYECON090A <sup>⑥</sup>	Downflow Economizer with Barometric Relief	WSD150E-240E
BAYECON092A	Horizontal Economizer	WSH150E-240E
BAYECON701A	Downflow Low Leak Economizer	WSD150F-240F
BAYENTH007A	Reference Enthalpy Kit	All BAYECON089-92A
BAYENTH008A	Comparative Enthalpy Kit	All BAYECON089-92A
BAYFRST003A	High Temperature Stat	WS*150E-240E
BAYGARD045A <sup>⑥</sup>	Tool-less Hail Guard	WS*150E, WS*180E
BAYGARD050A <sup>⑥</sup>	Tool-less Hail Guard	WS*240E
BAYHSDR005B <sup>①</sup>	High Static Drive	WS*150E-240E
BAYHSMT055B	5HP OVERSIZED MOTOR KIT (208-230/460)	WS*150E, WS*180E
BAYHSMT072A	5HP OVERSIZED MOTOR KIT (575)	WS*150E, WS*180E
BAYHSMT100A	7.5HP OVERSIZED MOTOR KIT (208-230)	WS*240E
BAYHSMT101A	7.5HP OVERSIZED MOTOR KIT (460)	WS*240E
BAYHSMT102A	7.5HP OVERSIZED MOTOR KIT (575)	WS*240E
BAYLOAM023A <sup>⑤⑥</sup>	Evaporator Defrost Control (Frostat)	WS*150E, WS*180E
BAYLOAM031A	Evaporator Defrost Control	WS*240E
BAYLSDR004A	Low Static Drive	WS*240E
BAYLSDR011A	Low Static Drive	WS*150E, WS*180E
BAYPWRX029A	Power Exhaust for all Voyagers 12½-20 Ton 230V units	Downflow Only
BAYPWRX030A	Power Exhaust for all Voyagers 12½-20 Ton 460V units	Downflow Only
BAYPWRX031A	Power Exhaust for all Voyagers 12½-20 Ton 575V units	Downflow Only
BAYQACB044A	Adapter Curb	BAYCURB026A/B to BAYCURB027A/B
BAYSERV001A	Selective Resistance Service Tester	All Voyagers 12½-20 Tons
BAYSTAT023	Remote Potentiometer	All BAYECON089-92A
BAYTUBE008A <sup>②⑤⑥</sup>	Discharge Air Sensing Kit	All Voyagers 12½-20 Tons Downflow
BAYTUBE009A <sup>②⑤⑥</sup>	Discharge Air Sensing Kit	All Voyagers 12½-20 Tons Horizontal
BAYVNOR002B <sup>⑤</sup>	Ventilation Override Kit	WS*150-240E w/ReliaTel™ Options Module

① High static drive and oversized motors are mutually exclusive. Do not Combine.  
 ② Used for true discharge air sensing in both heating and cooling models.  
 ③ Clarksville Manufacturing has a no-return policy for this roof curb.  
 ④ For downflow use only. Can not be adapted for horizontal units.  
 ⑤ BAYABRD002B is required when ordering field installed accessories BAYDFPS005A or 006A, BAYTUBE008A or 009A and BAYLOAM023A, BAYLOAM031A or BAYVNOR002B.  
 ⑥ Field or factory installed option.  
 ⑦ Field installed accessory. Requires an economizer.  
 \* Information subject to change. Please confirm with current Product Data/Service Facts for current factory production.

# Packaged Heat Pump with ReliaTel™ Controls 12½-20 Tons Heaters

**Table LPH-13-A — Downflow Supplementary Heaters:**

Model Number	Power Supply	kW Rating	BTUH	Nominal Stages	Used With
AYDHTRK318A	208-230/3/60	13.5/18.0	46,100/61,400	1	WSD150-180E
AYDHTRK336A	208-230/3/60	27.0/36.0	92,200/122,900	2	WSD150-180E
AYDHTRK354A	208-230/3/60	40.5/54.0	138,200/184,300	2	WSD150-180E
AYDHTRK418A	460/3/60	18.0	61,400	1	WSD150-180E
AYDHTRK436A	460/3/60	36.0	122,900	2	WSD150-180E
AYDHTRK454A	460/3/60	54.0	184,300	2	WSD150-180E
AYDHTRL336A	208-230/3/60	27.0/36.0	92,200/122,900	2	WSD240E
AYDHTRL354A	208-230/3/60	40.5/54.0	138,200/184,300	2	WSD240E
AYDHTRK372A	208-230/3/60	54.0/72.0	184,300/245,700	2	WSD240E
AYDHTRL436A	460/3/60	36.0	122,900	2	WSD240E
AYDHTRL454A	460/3/60	54.0	184,300	2	WSD240E
AYDHTRK472A	460/3/60	72.0	245,700	2	WSD240E
AYDHTRKW18A	575/3/60	18.0	61,400	1	WSD150-180E
AYDHTRKW36A	575/3/60	36.0	122,900	2	WSD150-180E
AYDHTRKW54A	575/3/60	54.0	184,300	2	WSD150-180E
AYDHTRLW36A	575/3/60	36.0	122,900	2	WSD240E
AYDHTRLW54A	575/3/60	54.0	184,300	2	WSD240E
AYDHTRKW72A	575/3/60	72.0	245,700	2	WSD240E

**Table LPH-13-B — Horizontal Supplementary Heaters:**

AYHHTRM318A	208-230/3/60	13.5/18.0	46,100/61,400	1	WSH150-180E
AYHHTRM336A	208-230/3/60	27.0/36.0	92,200/122,900	2	WSH150-180E
AYHHTRM354A	208-230/3/60	40.5/54.0	138,200/184,300	2	WSH150-180E
AYHHTRM418A	460/3/60	18.0	61,400	1	WSH150-180E
AYHHTRP436A	460/3/60	36.0	122,900	2	WSH150-180E
AYHHTRM454A	460/3/60	54.0	184,300	2	WSH150-180E
AYHHTRN336A	208-230/3/60	27.0/36.0	92,200/122,900	2	WSH240E
AYHHTRN354A	208-230/3/60	40.5/54.0	138,200/184,300	2	WSH240E
AYHHTRN372A	208-230/3/60	54.0/72.0	184,300/245,700	2	WSH240E
AYHHTRN436A	460/3/60	36.0	122,900	2	WSH240E
AYHHTRN454A	460/3/60	54.0	184,300	2	WSH240E
AYHHTRN472A	460/3/60	72.0	245,700	2	WSH240E
AYHHTRMW18A	575/3/60	18.0	61,400	1	WSH150-180E
AYHHTRMW36A	575/3/60	36.0	122,900	2	WSH150-180E
AYHHTRMW54A	575/3/60	54.0	184,300	2	WSH150-180E
AYHHTRNW36A	575/3/60	36.0	122,900	2	WSH240E
AYHHTRNW54A	575/3/60	54.0	184,300	2	WSH240E
AYHHTRNW72A	575/3/60	72.0	245,700	2	WSH240E

Note: Unit with heater is single circuit/single point.

**See ReliaTel™ and Micro Control features on LPC-14 and LPC-15.**

## Packaged Gas/Electric Convertible 3-10 Tons



Beveled Top  
Smoother Design  
Small compact cabinet  
Recessed access handles

### Standard Features:

- American Standard Heating & Air Conditioning scroll compressors on all 3-10 ton units
- Colored and numbered wiring
- Phase Monitor, R-410A, 3 Phase Units
- Provisions for through the Base Gas and Condensate Drain Connections
- 2" throwaway filters provided on all units
- Liquid Line Refrigerant Drier
- Operating Charge of R-410A
- IAQ Sloped Drain Pans
- Low Ambient to 40°F on Electromechanical models
- Low Ambient to 0°F on ReliaTel™ models
- 5 - year Limited Compressor Warranty
- 5 - year Limited Heat Exchanger Warranty
- 1 - year Limited Parts Warranty

### Added Flexibility

- Electromechanical or ReliaTel™ controls (**See page LPC-14 for ReliaTel™ Control Information**)
- Standard or high efficiency cooling models available. 17+ available in 3T to 5T. For reference to 17+ please refer to publications RT-PRC048-EN and RT-SLB020-EN.
- Low, medium or high heat, single or two stage
- Convertible airflow
- Fork lift openings on three sides of unit
- Direct or belt drive - standard or oversized motors
- We don't prepackage options
- Choose options tailored to suit each job —pay only for what is needed
- Units ship with options installed —and within our standard ship cycle time

### Factory Installed Options

- Through-the-Base — Electrical
- Convenience Outlet — Powered or unpowered
- Unit Disconnect Switch
- Circuit Breaker
- Smoke Detectors — Supply, return, or both
- Condenser Coil Coating
- Hinged Access Service Panels
- Discharge Air Sensor
- Fan Fail and Clogged Filter Switches
- Condenser Coil Guard — Hail Protection Quality
- Hot Gas Reheat Coil - Dehumidification
- Expansion valve and split face evaporator coil
- Novar Controls
- Comm 3/4 Communications Interface
- 2" Pleated Media filters (MERV 8 & 13)
- Froststat
- Multi-Speed & Single Zone VAV ID Airflow
- Demand Control Ventilation
- Stainless Steel Drainpan
- Condensate Drainpan Overflow Switch

**The same American Standard Heating & Air Conditioning Quality and Reliability ... with added Flexibility!**

# Packaged Gas/Electric Convertible 3-5 Tons, 17 SEER, R-410A

**Table LPG-2-A — 17 Plus - R-410A - ReliaTel™ Controls Only**

Tons	Unit Ordering No.	Performance SEER	Cooling Capacity (Btuh)	Heating Output Capacity (Btuh) <sup>①</sup>	AFUE%	Cabinet Dimensions (in.) H x W x L	Downflow Supply	Downflow Return	Shipping Weight (lbs.)	MCA**	Max. Fuse**
<b>YHC - 208-230/3/60 - Three Phase - Low Heat</b>											
3	YHC037E3RLA0000	17.5	36,500	48,000	78	36 x 44 x 69	16 x 15.5	24 x 14	676	23.3	30
4	YHC047E3RLA0000	17.5	50,500	49,000	80	41 x 53 x 88	33 x 17.5	32 x 17.5	858	29.4	40
5	YHC067E3RLA0000	17.2	60,000	49,000	80	41 x 53 x 88	33 x 17.5	32 x 17.5	917	32.2	45
<b>YHC - 460/3/60 - Three Phase - Low Heat</b>											
3	YHC037E4RLA0000	17.5	36,500	48,000	78	36 x 44 x 69	16 x 15.5	24 x 14	676	23.3	15
4	YHC047E4RLA0000	17.5	50,500	49,000	80	41 x 53 x 88	33 x 17.5	32 x 17.5	858	29.4	20
5	YHC067E4RLA0000	17.2	60,000	49,000	80	41 x 53 x 88	33 x 17.5	32 x 17.5	917	32.2	20
<b>YHC - 575/3/60 - Three Phase - Low Heat</b>											
3	YHC037EWRLA0000	17.5	36,500	48,000	78	36 x 44 x 69	16 x 15.5	24 x 14	676	8.7	15
4	YHC047EWRLA0000	17.5	50,500	49,000	80	41 x 53 x 88	33 x 17.5	32 x 17.5	858	10.4	15
5	YHC067EWRLA0000	17.2	60,000	49,000	80	41 x 53 x 88	33 x 17.5	32 x 17.5	917	11.2	15
<b>YHC - 208-230/3/60 - Three Phase - Medium Heat</b>											
3	YHC037E3RMA0000	17.5	36,500	64,000	78	36 x 44 x 69	16 x 15.5	24 x 14	676	23.3	30
4	YHC047E3RMA0000	17.5	50,500	64,000	80	41 x 53 x 88	33 x 17.5	32 x 17.5	858	29.4	40
5	YHC067E3RMA0000	17.2	60,000	64,000	80	41 x 53 x 88	33 x 17.5	32 x 17.5	917	32.2	45
<b>YHC - 460/3/60 - Three Phase - Medium Heat</b>											
3	YHC037E4RMA0000	17.5	36,500	64,000	78	36 x 44 x 69	16 x 15.5	24 x 14	676	23.3	15
4	YHC047E4RMA0000	17.5	50,500	64,000	80	41 x 53 x 88	33 x 17.5	32 x 17.5	858	29.4	20
5	YHC067E4RMA0000	17.2	60,000	64,000	80	41 x 53 x 88	33 x 17.5	32 x 17.5	917	32.2	20
<b>YHC - 575/3/60 - Three Phase - Medium Heat</b>											
3	YHC037EWRMA0000	17.5	36,500	64,000	78	36 x 44 x 69	16 x 15.5	24 x 14	676	8.7	15
4	YHC047EWRMA0000	17.5	50,500	64,000	80	41 x 53 x 88	33 x 17.5	32 x 17.5	858	10.4	15
5	YHC067EWRMA0000	17.2	60,000	64,000	80	41 x 53 x 88	33 x 17.5	32 x 17.5	917	11.2	15
<b>YHC - 208-230/3/60 - Three Phase - High Heat</b>											
3	YHC037E3RMA0000	17.5	36,500	80,000	78	36 x 44 x 69	16 x 15.5	24 x 14	676	23.3	30
4	YHC047E3RMA0000	17.5	50,500	96,000	80	41 x 53 x 88	33 x 17.5	32 x 17.5	858	29.4	40
5	YHC067E3RMA0000	17.2	60,000	104,000	80	41 x 53 x 88	33 x 17.5	32 x 17.5	917	32.2	45
<b>YHC - 460/3/60 - Three Phase - High Heat</b>											
3	YHC037E4RMA0000	17.5	36,500	80,000	78	36 x 44 x 69	16 x 15.5	24 x 14	676	23.3	15
4	YHC047E4RMA0000	17.5	50,500	96,000	80	41 x 53 x 88	33 x 17.5	32 x 17.5	858	29.4	20
5	YHC067E4RMA0000	17.2	60,000	104,000	80	41 x 53 x 88	33 x 17.5	32 x 17.5	917	32.2	20
<b>YHC - 575/3/60 - Three Phase - High Heat</b>											
3	YHC037EWRMA0000	17.5	36,500	80,000	78	36 x 44 x 69	16 x 15.5	24 x 14	676	8.7	15
4	YHC047EWRMA0000	17.5	50,500	96,000	80	41 x 53 x 88	33 x 17.5	32 x 17.5	858	10.4	15
5	YHC067EWRMA0000	17.2	60,000	104,000	80	41 x 53 x 88	33 x 17.5	32 x 17.5	917	11.2	15

① Downflow Airflow/Horizontal Airflow

\*\* Information subject to change. Please confirm with current Product Data/Service Facts for current factory production.

# Packaged Gas/Electric Convertible 3-5 Tons, 15 SEER, R-410A

**Table LPG-3-A - Base Unit - 15 SEER High Efficiency - Electromechanical or ReliaTel™**

Tons	Unit Ordering No.	Performance SEER	Cooling Capacity (Btuh)	Heating Output <sup>①</sup> Capacity (Btuh)	AFUE%	Cabinet Dimensions (in.) H x W x L	Downflow Supply	Downflow Return	Shipping Weight (lbs.)	MCA**	Max. Fuse**
<b>YHC - 208-230/1/60 - Single Phase - Low Heat</b>											
3	YHC036E1*LB0000	15.2	38,490	48,000	81	36 x 44 x 69	16 x 15.5	24 x 14	555	26.7	40
4	YHC048F1*LB0000	15.0	48,930	48,000	81	41 x 53 x 88	33 x 17.5	32 x 17.5	798	35.7	50
5	YHC060F1*LB0000	15.0	62,490	48,000	81	41 x 53 x 88	33 x 17.5	32 x 17.5	823	43.8	70
<b>YHC - 208-230/3/60 - Three Phase - Low Heat</b>											
3	YHC036E3*LA0000	15.0	38,490	48,000	78	36 x 44 x 69	16 x 15.5	24 x 14	637	21.9	30
4	YHC048F3*LA0000	15.0	48,930	48,000	80	41 x 53 x 88	33 x 17.5	32 x 17.5	869	28.3	40
5	YHC060F3*LA0000	15.0	62,490	48,000	80	41 x 53 x 88	33 x 17.5	32 x 17.5	894	32.1	45
<b>YHC - 460/3/60 - Three Phase - Low Heat</b>											
3	YHC036E4*LA0000	15.0	38,490	48,000	78	36 x 44 x 69	16 x 15.5	24 x 14	637	10.2	15
4	YHC048F4*LA0000	15.0	48,930	48,000	80	41 x 53 x 88	33 x 17.5	32 x 17.5	869	13.8	20
5	YHC060F4*LA0000	15.0	62,490	48,000	80	41 x 53 x 88	33 x 17.5	32 x 17.5	894	17.0	20
<b>YHC - 575/3/60 - Three Phase - Medium Heat</b>											
3	YHC036EW*LA0000	14.4	38,490	48,000	78	36 x 44 x 69	16 x 15.5	24 x 14	637	7.9	15
4	YHC048FW*LA0000	15.0	48,930	48,000	80	41 x 53 x 88	33 x 17.5	32 x 17.5	869	9.8	15
5	YHC060FW*LA0000	15.0	62,490	48,000	80	41 x 53 x 88	33 x 17.5	32 x 17.5	894	10.2	15
<b>YHC - 208-230/1/60 - Single Phase - Medium Heat</b>											
3	YHC036E1*MB0000	15.2	38,490	65,000	81	36 x 44 x 69	16 x 15.5	24 x 14	555	26.7	40
4	YHC048F1*MB0000	15.0	48,930	64,000	81	41 x 53 x 88	33 x 17.5	32 x 17.5	798	35.7	50
5	YHC060F1*MB0000	15.0	62,490	64,000	81	41 x 53 x 88	33 x 17.5	32 x 17.5	823	43.8	70
<b>YHC - 208-230/3/60 - Three Phase - Medium Heat</b>											
3	YHC036E3*MA0000	15.0	36,500	64,000	78	36 x 44 x 69	16 x 15.5	24 x 14	676	21.9	30
4	YHC048F3*MA0000	15.0	50,500	64,000	79	41 x 53 x 88	33 x 17.5	32 x 17.5	858	28.3	40
5	YHC060F3*MA0000	15.0	60,000	64,000	79	41 x 53 x 88	33 x 17.5	32 x 17.5	917	32.1	45
<b>YHC - 460/3/60 - Three Phase - High Heat</b>											
3	YHC036E4*MA0000	15.0	36,500	64,000	78	36 x 44 x 69	16 x 15.5	24 x 14	676	10.2	15
4	YHC048F4*MA0000	15.0	50,500	64,000	79	41 x 53 x 88	33 x 17.5	32 x 17.5	858	13.8	20
5	YHC060F4*MA0000	15.0	60,000	64,000	79	41 x 53 x 88	33 x 17.5	32 x 17.5	917	17.0	20
<b>YHC - 575/3/60 - Three Phase - High Heat</b>											
3	YHC036EW*MA0000	14.4	36,500	64,000	78	36 x 44 x 69	16 x 15.5	24 x 14	676	7.9	15
4	YHC048FW*MA0000	15.0	50,500	64,000	79	41 x 53 x 88	33 x 17.5	32 x 17.5	858	9.8	15
5	YHC060FW*MA0000	15.0	60,000	64,000	79	41 x 53 x 88	33 x 17.5	32 x 17.5	917	10.2	15
<b>YHC - 208-230/1/60 - Single Phase - High Heat</b>											
3	YHC036E1*HB0000	15.2	38,490	96,000	81	36 x 44 x 69	16 x 15.5	24 x 14	555	26.7	40
4	YHC048F1*HB0000	15.0	48,930	96,000	81	41 x 53 x 88	33 x 17.5	32 x 17.5	798	35.7	50
5	YHC060F1*HB0000	15.0	62,490	104,000	81	41 x 53 x 88	33 x 17.5	32 x 17.5	823	43.8	70
<b>YHC - 208-230/3/60 - Three Phase - High Heat</b>											
3	YHC036E3*HA0000	15.0	36,500	96,000	78	36 x 44 x 69	16 x 15.5	24 x 14	676	23.3	30
4	YHC048F3*HA0000	15.0	50,500	96,000	79	41 x 53 x 88	33 x 17.5	32 x 17.5	858	29.4	40
5	YHC060F3*HA0000	15.0	60,000	104,000	80	41 x 53 x 88	33 x 17.5	32 x 17.5	917	32.2	45
<b>YHC - 460/3/60 - Three Phase - High Heat</b>											
3	YHC036E4*HA0000	15.0	36,500	96,000	78	36 x 44 x 69	16 x 15.5	24 x 14	676	23.3	15
4	YHC048F4*HA0000	15.0	50,500	96,000	79	41 x 53 x 88	33 x 17.5	32 x 17.5	858	29.4	20
5	YHC060F4*HA0000	15.0	60,000	104,000	80	41 x 53 x 88	33 x 17.5	32 x 17.5	917	32.2	20
<b>YHC - 575/3/60 - Three Phase - High Heat</b>											
3	YHC036EW*HA0000	14.4	36,500	96,000	78	36 x 44 x 69	16 x 15.5	24 x 14	676	7.9	15
4	YHC048FW*HA0000	15.0	50,500	96,000	79	41 x 53 x 88	33 x 17.5	32 x 17.5	858	9.8	15
5	YHC060FW*HA0000	15.0	60,000	104,000	80	41 x 53 x 88	33 x 17.5	32 x 17.5	917	10.2	15

① Downflow Airflow/Horizontal Airflow

\* Digit 9-E=Electromechanical or R=ReliaTel™.

\*\* Information subject to change. Please confirm with current Product Data/Service Facts for current factory production.

For complete equipment / combination selections, installation instructions and warranty information, please refer to Product Data/Ratings and/or Installers Guides and Limited Warranty Handbooks.

# Packaged Gas/Electric Convertible 3-5 Tons, 14 SEER, R-410A

**Table LPG-4-A - Base Unit - 14 SEER - Electromechanical or ReliaTel™**

Tons	Unit Ordering No.	Performance SEER	Cooling Capacity (Btuh)	Heating Output <sup>①</sup> Capacity (Btuh)	AFUE%	Cabinet Dimensions (in.) H x W x L	Downflow Supply	Downflow Return	Shipping Weight (lbs.)	MCA**	Max. Fuse**
<b>YSC - 208-230/3/60 - Three Phase - Low Heat</b>											
3	YSC036G3*LA0000	14.0	38,490	48,000	82	36 x 44 x 69	16 x 15.5	24 x 14	555	19.9	30
4	YSC048G3*LA0000	14.0	48,930	48,000	82	41 x 53 x 88	33 x 17.5	32 x 17.5	798	25.4	35
5	YSC060G3*LA0000	14.0	62,490	48,000	82	41 x 53 x 88	33 x 17.5	32 x 17.5	823	28.3	40
<b>YSC - 460/3/60 - Three Phase - Low Heat</b>											
3	YSC036G4*LA0000	14.0	38,490	48,000	82	36 x 44 x 69	16 x 15.5	24 x 14	637	9.5	15
4	YSC048G4*LA0000	14.0	48,930	48,000	82	41 x 53 x 88	33 x 17.5	32 x 17.5	869	11	15
5	YSC060G4*LA0000	14.0	62,490	48,000	82	41 x 53 x 88	33 x 17.5	32 x 17.5	894	12	15
<b>YSC - 575/3/60 - Three Phase - Low Heat</b>											
3	YSC036GW*LA0000	14.0	38,490	48,000	82	36 x 44 x 69	16 x 15.5	24 x 14	637	7.6	15
4	YSC048GW*LA0000	14.0	48,930	48,000	82	41 x 53 x 88	33 x 17.5	32 x 17.5	869	9.4	15
5	YSC060GW*LA0000	14.0	62,490	48,000	82	41 x 53 x 88	33 x 17.5	32 x 17.5	894	9.9	15
<b>YSC - 208-230/3/60 - Three Phase - Low Heat</b>											
3	YSC036G3*MA0000	14.0	38,490	48,000	82	36 x 44 x 69	16 x 15.5	24 x 14	637	19.9	30
4	YSC048G3*MA0000	14.0	48,930	48,000	82	41 x 53 x 88	33 x 17.5	32 x 17.5	869	25.4	35
5	YSC060G3*MA0000	14.0	62,490	48,000	82	41 x 53 x 88	33 x 17.5	32 x 17.5	894	28.3	40
<b>YSC - 460/3/60 - Three Phase - Low Heat</b>											
3	YSC036G4*MA0000	14.0	38,490	65,000	82	36 x 44 x 69	16 x 15.5	24 x 14	555	9.5	15
4	YSC048G4*MA0000	14.0	48,930	64,000	82	41 x 53 x 88	33 x 17.5	32 x 17.5	798	11	15
5	YSC060G4*MA0000	14.0	62,490	64,000	82	41 x 53 x 88	33 x 17.5	32 x 17.5	823	12	15
<b>YSC - 575/3/60 - Three Phase - Low Heat</b>											
3	YSC036GW*MA0000	14.0	36,500	64,000	82	36 x 44 x 69	16 x 15.5	24 x 14	676	7.6	15
4	YSC048GW*MA0000	14.0	50,500	64,000	82	41 x 53 x 88	33 x 17.5	32 x 17.5	858	9.4	15
5	YSC060GW*MA0000	14.0	60,000	64,000	82	41 x 53 x 88	33 x 17.5	32 x 17.5	917	9.9	15
<b>YSC - 208-230/3/60 - Three Phase - Low Heat</b>											
3	YSC036G3*HA0000	14.0	36,500	64,000	82	36 x 44 x 69	16 x 15.5	24 x 14	676	19.9	30
4	YSC048G3*HA0000	14.0	50,500	64,000	82	41 x 53 x 88	33 x 17.5	32 x 17.5	858	25.4	35
5	YSC060G3*HA0000	14.0	60,000	64,000	82	41 x 53 x 88	33 x 17.5	32 x 17.5	917	28.3	40
<b>YSC - 460/3/60 - Three Phase - Low Heat</b>											
3	YSC036G4*HA0000	14.0	36,500	64,000	82	36 x 44 x 69	16 x 15.5	24 x 14	676	9.5	15
4	YSC048G4*HA0000	14.0	50,500	64,000	82	41 x 53 x 88	33 x 17.5	32 x 17.5	858	11	15
5	YSC060G4*HA0000	14.0	60,000	64,000	82	41 x 53 x 88	33 x 17.5	32 x 17.5	917	12	15
<b>YSC - 575/3/60 - Three Phase - Low Heat</b>											
3	YSC036GW*HA0000	14.0	38,490	96,000	82	36 x 44 x 69	16 x 15.5	24 x 14	555	7.6	15
4	YSC048GW*HA0000	14.0	48,930	96,000	82	41 x 53 x 88	33 x 17.5	32 x 17.5	798	9.4	15
5	YSC060GW*HA0000	14.0	62,490	104,000	82	41 x 53 x 88	33 x 17.5	32 x 17.5	823	9.9	15

① Downflow Airflow/Horizontal Airflow

\* Digit 9-E=Electromechanical or R=ReliaTel™.

\*\* Information subject to change. Please confirm with current Product Data/Service Facts for current factory production.

Light Commercial  
Packaged Gas/Electric

# Packaged Gas/Electric Convertible 3-5 Tons, 13 SEER, R-410A

**Table LPG-5-A - Base Unit - 13 SEER - Electromechanical or ReliaTel™**

Tons	Unit Ordering No.	Performance SEER	Cooling Capacity (Btuh)	Heating Output <sup>①</sup> Capacity (Btuh)	AFUE%	Cabinet Dimensions (in.) H x W x L	Downflow Supply	Downflow Return	Shipping Weight (lbs.)	MCA**	Max. Fuse**
<b>YSC - 208-230/3/60 - Three Phase - Low Heat</b>											
3	YSC033G3*LA0000	13.0	38,490	48,000	82	36 x 44 x 69	16 x 15.5	24 x 14	555	26.7	40
4	YSC043G3*LA0000	13.0	48,930	48,000	82	41 x 53 x 88	33 x 17.5	32 x 17.5	798	35.7	50
5	YSC063G3*LA0000	13.0	62,490	48,000	82	41 x 53 x 88	33 x 17.5	32 x 17.5	823	43.8	70
<b>YSC - 460/3/60 - Three Phase - Low Heat</b>											
3	YSC033G4*LA0000	13.0	38,490	48,000	82	36 x 44 x 69	16 x 15.5	24 x 14	637	21.9	30
4	YSC043G4*LA0000	13.0	48,930	48,000	82	41 x 53 x 88	33 x 17.5	32 x 17.5	869	28.3	40
5	YSC063G4*LA0000	13.0	62,490	48,000	82	41 x 53 x 88	33 x 17.5	32 x 17.5	894	32.1	45
<b>YSC - 575/3/60 - Three Phase - Low Heat</b>											
3	YSC033GW*LA0000	13.0	38,490	48,000	82	36 x 44 x 69	16 x 15.5	24 x 14	637	10.2	15
4	YSC043GW*LA0000	13.0	48,930	48,000	82	41 x 53 x 88	33 x 17.5	32 x 17.5	869	13.8	20
5	YSC063GW*LA0000	13.0	62,490	48,000	82	41 x 53 x 88	33 x 17.5	32 x 17.5	894	17.0	20
<b>YSC - 208-230/3/60 - Three Phase - Low Heat</b>											
3	YSC033G3*MA0000	13.0	38,490	48,000	82	36 x 44 x 69	16 x 15.5	24 x 14	637	19.9	30
4	YSC043G3*MA0000	13.0	48,930	48,000	82	41 x 53 x 88	33 x 17.5	32 x 17.5	869	25.4	35
5	YSC063G3*MA0000	13.0	62,490	48,000	82	41 x 53 x 88	33 x 17.5	32 x 17.5	894	28.3	40
<b>YSC - 460/3/60 - Three Phase - Low Heat</b>											
3	YSC033G4*MA0000	13.0	38,490	65,000	82	36 x 44 x 69	16 x 15.5	24 x 14	555	26.7	40
4	YSC043G4*MA0000	13.0	48,930	64,000	82	41 x 53 x 88	33 x 17.5	32 x 17.5	798	35.7	50
5	YSC063G4*MA0000	13.0	62,490	64,000	82	41 x 53 x 88	33 x 17.5	32 x 17.5	823	43.8	70
<b>YSC - 575/3/60 - Three Phase - Low Heat</b>											
3	YSC033GW*MA0000	13.0	36,500	64,000	82	36 x 44 x 69	16 x 15.5	24 x 14	676	21.9	30
4	YSC043GW*MA0000	13.0	50,500	64,000	82	41 x 53 x 88	33 x 17.5	32 x 17.5	858	28.3	40
5	YSC063GW*MA0000	13.0	60,000	64,000	82	41 x 53 x 88	33 x 17.5	32 x 17.5	917	32.1	45
<b>YSC - 208-230/3/60 - Three Phase - Low Heat</b>											
3	YSC033G3*HA0000	13.0	36,500	64,000	82	36 x 44 x 69	16 x 15.5	24 x 14	676	10.2	15
4	YSC043G3*HA0000	13.0	50,500	64,000	82	41 x 53 x 88	33 x 17.5	32 x 17.5	858	13.8	20
5	YSC063G3*HA0000	13.0	60,000	64,000	82	41 x 53 x 88	33 x 17.5	32 x 17.5	917	17.0	20
<b>YSC - 460/3/60 - Three Phase - Low Heat</b>											
3	YSC033G4*HA0000	13.0	36,500	64,000	82	36 x 44 x 69	16 x 15.5	24 x 14	676	9.5	15
4	YSC043G4*HA0000	13.0	50,500	64,000	82	41 x 53 x 88	33 x 17.5	32 x 17.5	858	11	15
5	YSC063G4*HA0000	13.0	60,000	64,000	82	41 x 53 x 88	33 x 17.5	32 x 17.5	917	12.9	20
<b>YSC - 575/3/60 - Three Phase - Low Heat</b>											
3	YSC033GW*HA0000	13.0	38,490	96,000	82	36 x 44 x 69	16 x 15.5	24 x 14	555	26.7	40
4	YSC043GW*HA0000	13.0	48,930	96,000	82	41 x 53 x 88	33 x 17.5	32 x 17.5	798	35.7	50
5	YSC063GW*HA0000	13.0	62,490	104,000	82	41 x 53 x 88	33 x 17.5	32 x 17.5	823	43.8	70

① Downflow Airflow/Horizontal Airflow

\* Digit 9-E=Electromechanical or R=ReliaTel™.

\*\* Information subject to change. Please confirm with current Product Data/Service Facts for current factory production.

# Packaged Gas/Electric Convertible 3-5 Tons, 13 SEER, R-410A

**Table LPG-6-A — Base Unit — 13 SEER — Electromechanical or ReliaTel™**

Tons	Unit Ordering No.	Performance SEER	Cooling Capacity (Btuh)	Heating Output <sup>①</sup>		Cabinet Dimensions (in.) H x W x L	Downflow Supply	Downflow Return	Shipping Weight (lbs.)	MCA**	Max. Fuse**
				Capacity (Btuh)	AFUE%						
<b>YSC –208-230/3/60 – Three Phase – Low Heat</b>											
3	YSC036E3*LA0000	13.0	37,150	48,000	80	36 x 43 x 69	18 x 15.5	12 x 14	607	23.0	35
4	YSC048E3*LA0000	13.0	49,450	48,000	80	36 x 43 x 69	18 x 15.5	12 x 14	638	25.2	35
5	YSC060E3*LA0000	13.0	62,270	48,000	80	36 x 43 x 69	18 x 15.5	12 x 14	688	29.5	45
<b>YSC –460/3/60 – Three Phase – Low Heat</b>											
3	YSC036E4*LA0000	13.0	37,150	48,000	80	36 x 43 x 69	18 x 15.5	12 x 14	607	11.7	15
4	YSC048E4*LA0000	13.0	49,450	48,000	80	36 x 43 x 69	18 x 15.5	12 x 14	638	12.5	15
5	YSC060E4*LA0000	13.0	62,270	48,000	80	36 x 43 x 69	18 x 15.5	12 x 14	688	15.5	25
<b>YSC –575/3/60 – Three Phase – Low Heat</b>											
3	YSC036EW*LA0000	13.0	37,150	48,000	80	36 x 43 x 69	18 x 15.5	12 x 14	607	9.4	15
4	YSC048EW*LA0000	13.0	49,450	48,000	80	36 x 43 x 69	18 x 15.5	12 x 14	638	9.0	15
5	YSC060EW*LA0000	13.0	62,270	48,000	80	36 x 43 x 69	18 x 15.5	12 x 14	688	10.1	15
<b>YSC –208-230/3/60 – Three Phase – Medium Heat</b>											
3	YSC036E3*MA0000	13.0	37,150	64,000	81	36 x 43 x 69	18 x 15.5	12 x 14	607	23.0	35
4	YSC048E3*MA0000	13.0	49,450	64,000	81	36 x 43 x 69	18 x 15.5	12 x 14	638	25.2	35
5	YSC060E3*MA0000	13.0	62,270	64,000	81	36 x 43 x 69	18 x 15.5	12 x 14	688	29.5	45
<b>YSC –460/3/60 – Three Phase – Medium Heat</b>											
3	YSC036E4*MA0000	13.0	37,150	64,000	80	36 x 43 x 69	18 x 15.5	12 x 14	607	11.7	15
4	YSC048E4*MA0000	13.0	49,450	64,000	80	36 x 43 x 69	18 x 15.5	12 x 14	638	12.5	15
5	YSC060E4*MA0000	13.0	62,270	64,000	80	36 x 43 x 69	18 x 15.5	12 x 14	688	15.5	25
<b>YSC –575/3/60 – Three Phase – Medium Heat</b>											
3	YSC036EW*MA0000	13.0	37,150	64,000	80	36 x 43 x 69	18 x 15.5	12 x 14	607	9.4	15
4	YSC048EW*MA0000	13.0	49,450	64,000	80	36 x 43 x 69	18 x 15.5	12 x 14	638	9.0	15
5	YSC060EW*MA0000	13.0	62,270	64,000	80	36 x 43 x 69	18 x 15.5	12 x 14	688	10.1	15
<b>YSC –208-230/3/60 – Three Phase – High Heat</b>											
3	YSC036E3*HA0000	13.0	37,150	96,000	80	36 x 43 x 69	18 x 15.5	12 x 14	607	23.0	35
4	YSC048E3*HA0000	13.0	49,450	96,000	80	36 x 43 x 69	18 x 15.5	12 x 14	638	25.2	35
5	YSC060E3*HA0000	13.0	62,270	104,000	80	36 x 43 x 69	18 x 15.5	12 x 14	688	29.5	45
<b>YSC –460/3/60 – Three Phase – High Heat</b>											
3	YSC036E4*HA0000	13.0	37,150	96,000	80	36 x 43 x 69	18 x 15.5	12 x 14	607	11.7	15
4	YSC048E4*HA0000	13.0	49,450	96,000	80	36 x 43 x 69	18 x 15.5	12 x 14	638	12.5	15
5	YSC060E4*HA0000	13.0	62,270	104,000	80	36 x 43 x 69	18 x 15.5	12 x 14	688	15.5	25
<b>YSC –575/3/60 – Three Phase – High Heat</b>											
3	YSC036EW*HA0000	13.0	37,150	96,000	80	36 x 43 x 69	18 x 15.5	12 x 14	607	9.4	15
4	YSC048EW*HA0000	13.0	49,450	96,000	80	36 x 43 x 69	18 x 15.5	12 x 14	638	9.0	15
5	YSC060EW*HA0000	13.0	62,270	104,000	80	36 x 43 x 69	18 x 15.5	12 x 14	688	10.1	15

① Downflow Airflow/Horizontal Airflow

\* Digit 9-E=Electromechanical or R=ReliaTel™.

\*\* Information subject to change. Please confirm with current Product Data/Service Facts for current factory production.



# Packaged Gas/Electric Convertible 6-10 Tons, High Efficiency, R-410A

**Table LPG-7-A — Base Unit — High Efficiency — Electromechanical or ReliaTel™**

Tons	Unit Ordering No.	Performance EER	Cooling Capacity (Btuh)	Heating Output <sup>①</sup> Capacity (Btuh)	AFUE%	Cabinet Dimensions (in.) H x W x L	Downflow Supply	Downflow Return	Shipping Weight (lbs.)	MCA**	Max. Fuse**
<b>YHC - 208/230/3/60 - Three Phase - Low Heat</b>											
6	YHC072F3*LA0000	12.6	72,000	64,800	80	47 x 53 x 88	33 x 17.5	32 x 17.5	997	33.9	50
6	YHC074F3*LA0000	13.1	73,000	64,800	81	47 x 53 x 88	33 x 17.5	32 x 17.5	1114	37.4	50
7 ½	YHC092F3*LA0000	12.6	92,000	96,000	80	47 x 53 x 88	33 x 17.5	32 x 17.5	1124	41.9	50
8 ½	YHC102F3*LA0000	12.5	103,000	96,000	80	47 x 53 x 88	33 x 17.5	32 x 17.5	1124	42.0	50
10	YHC120F3*LA0000	12.5	119,000	120,000	80	51 x 63 x 100	33 x 17.5	32 x 17.5	1563	50.3	60
<b>YHC - 460/3/60 - Three Phase - Low Heat</b>											
6	YHC072F4*LA0000	12.6	72,000	64,800	80	47 x 53 x 88	33 x 17.5	32 x 17.5	997	16.3	25
6	YHC074F4*LA0000	13.1	73,000	64,800	81	47 x 53 x 88	33 x 17.5	32 x 17.5	1114	18.7	25
7 ½	YHC092F4*LA0000	12.6	92,000	96,000	80	47 x 53 x 88	33 x 17.5	32 x 17.5	1124	19.9	25
8 ½	YHC102F4*LA0000	12.5	103,000	96,000	80	47 x 53 x 88	33 x 17.5	32 x 17.5	1124	19.9	25
10	YHC120F4*LA0000	12.5	119,000	120,000	80	51 x 63 x 100	33 x 17.5	32 x 17.5	1563	24.9	30
<b>YHC - 575/3/60 - Three Phase - Low Heat</b>											
6	YHC072FW*LA0000	12.6	72,000	64,800	80	47 x 53 x 88	33 x 17.5	32 x 17.5	997	12.7	15
7 ½	YHC092FW*LA0000	12.6	92,000	96,000	80	47 x 53 x 88	33 x 17.5	32 x 17.5	1124	15.6	20
8 ½	YHC102FW*LA0000	12.5	103,000	96,000	80	47 x 53 x 88	33 x 17.5	32 x 17.5	1124	16.5	20
10	YHC120FW*LA0000	12.5	119,000	120,000	80	51 x 63 x 100	33 x 17.5	32 x 17.5	1563	16.4	20
<b>YHC - 208/230/3/60 - Three Phase - Medium Heat</b>											
6	YHC072F3*MA0000	12.6	72,000	96,000	80	47 x 53 x 88	33 x 17.5	32 x 17.5	997	33.9	50
6	YHC074F3*MA0000	13.1	73,000	97,200	81	47 x 53 x 88	33 x 17.5	32 x 17.5	1114	37.4	50
7 ½	YHC092F3*MA0000	12.6	92,000	120,000	80	47 x 53 x 88	33 x 17.5	32 x 17.5	1124	41.9	50
8 ½	YHC102F3*MA0000	12.5	103,000	120,000	80	47 x 53 x 88	33 x 17.5	32 x 17.5	1124	42.0	50
10	YHC120F3*MA0000	12.5	119,000	160,000	80	51 x 63 x 100	33 x 17.5	32 x 17.5	1563	50.3	60
<b>YHC - 460/3/60 - Three Phase - Medium Heat</b>											
6	YHC072F4*MA0000	12.6	72,000	96,000	80	47 x 53 x 88	33 x 17.5	32 x 17.5	997	16.3	25
6	YHC074F4*MA0000	13.1	73,000	97,200	81	47 x 53 x 88	33 x 17.5	32 x 17.5	1114	18.7	25
7 ½	YHC092F4*MA0000	12.6	92,000	120,000	80	47 x 53 x 88	33 x 17.5	32 x 17.5	1124	19.9	25
8 ½	YHC102F4*MA0000	12.5	103,000	120,000	80	47 x 53 x 88	33 x 17.5	32 x 17.5	1124	19.9	25
10	YHC120F4*MA0000	12.5	119,000	160,000	80	51 x 63 x 100	33 x 17.5	32 x 17.5	1563	24.9	30
<b>YHC - 575/3/60 - Three Phase - Medium Heat</b>											
6	YHC072FW*MA0000	12.6	72,000	96,000	80	47 x 53 x 88	33 x 17.5	32 x 17.5	997	12.7	15
7 ½	YHC092FW*MA0000	12.6	92,000	120,000	80	47 x 53 x 88	33 x 17.5	32 x 17.5	1124	15.6	20
8 ½	YHC102FW*MA0000	12.5	103,000	120,000	80	47 x 53 x 88	33 x 17.5	32 x 17.5	1124	16.5	20
10	YHC120FW*MA0000	12.5	119,000	160,000	80	51 x 63 x 100	33 x 17.5	32 x 17.5	1563	16.4	20
<b>YHC - 208/230/1/60 - Single Phase - High Heat</b>											
6	YHC072F3*HA0000	12.6	72,000	120,000	80	47 x 53 x 88	33 x 17.5	32 x 17.5	997	33.9	50
6	YHC074F3*HA0000	13.1	73,000	121,500/85,050	81	47 x 53 x 88	33 x 17.5	32 x 17.5	1114	37.4	50
7 ½	YHC092F3*HA0000	12.6	92,000	120,000	80	47 x 53 x 88	33 x 17.5	32 x 17.5	1124	41.9	50
8 ½	YHC102F3*HA0000	12.5	103,000	160,000	80	47 x 53 x 88	33 x 17.5	32 x 17.5	1124	42.0	50
10	YHC120F3*HA0000	12.5	119,000	200,000	80	51 x 63 x 100	33 x 17.5	32 x 17.5	1563	50.3	60
<b>YHC - 208/230/3/60 - Three Phase - High Heat</b>											
6	YHC072F4*HA0000	12.6	72,000	120,000	80	47 x 53 x 88	33 x 17.5	32 x 17.5	997	16.3	25
6	YHC074F4*HA0000	13.1	73,000	121,500/85,050	81	47 x 53 x 88	33 x 17.5	32 x 17.5	1114	18.7	25
7 ½	YHC092F4*HA0000	12.6	92,000	120,000	80	47 x 53 x 88	33 x 17.5	32 x 17.5	1124	19.9	25
8 ½	YHC102F4*HA0000	12.5	103,000	160,000	80	47 x 53 x 88	33 x 17.5	32 x 17.5	1124	19.9	25
10	YHC120F4*HA0000	12.5	119,000	200,000	80	51 x 63 x 100	33 x 17.5	32 x 17.5	1563	24.9	30
<b>YHC - 575/3/60 - Three Phase - High Heat</b>											
6	YHC072FW*HA0000	12.6	72,000	120,000	80	47 x 53 x 88	33 x 17.5	32 x 17.5	997	12.7	15
7 ½	YHC092FW*HA0000	12.6	92,000	120,000	80	47 x 53 x 88	33 x 17.5	32 x 17.5	1124	15.6	20
8 ½	YHC102FW*HA0000	12.5	103,000	160,000	80	47 x 53 x 88	33 x 17.5	32 x 17.5	1124	16.5	20
10	YHC120FW*HA0000	12.5	119,000	200,000	80	51 x 63 x 100	33 x 17.5	32 x 17.5	1563	16.4	20

① Downflow Airflow/Horizontal Airflow

\* Digit 9-E=Electromechanical or R=ReliaTel™.

\*\* Information subject to change. Please confirm with current Product Data/Service Facts for current factory production.

For complete equipment / combination selections, installation instructions and warranty information, please refer to Product Data/Ratings and/or Installers Guides and Limited Warranty Handbooks.

# Packaged Gas/Electric Convertible 6-10 Tons, R-410A

**Table LPG-8-A — Base Unit — Standard Efficiency — Electromechanical or ReliaTel™**

Tons	Unit Ordering No.	Performance <sup>②</sup> EER	Cooling Capacity (Btuh)	Heating Output <sup>①</sup>		Cabinet Dimensions (in.) H x W x L	Downflow Supply	Downflow Return	Shipping Weight (lbs.)	MCA**	Max. Fuse**
				Capacity (Btuh)	AFUE%						
<b>YSC -208-230/3/60 – Three Phase – Low Heat</b>											
6	YSC072F3*LA0000	11.2	75,000	64,800	80	41 x 53 x 89	33 x 17.5	32.13 x 17.5	936	36.5	50
7½	YSC090F3*LA0000	11.2	89,000	96,000	80	41 x 53 x 89	33 x 17.5	32.13 x 17.5	916	38.2	60
7½	YSC092F3*LA0000	11.2	94,000	97,200	80	47 x 53 x 89	33 x 17.5	32.13 x 17.5	1059	41.2	50
8½	YSC102F3*LA0000	11.2	102,000	97,200	80	47 x 53 x 89	33 x 17.5	32.13 x 17.5	1096	46.3	60
10	YSC120F3*LA0000	11.3	118,000	121,500	80	47 x 53 x 89	33 x 17.5	32.13 x 17.5	1156	49.6	60
<b>YSC -460/3/60 – Three Phase – Low Heat</b>											
6	YSC072F4*LA0000	11.2	75,000	64,800	80	41 x 53 x 89	33 x 17.5	32.13 x 17.5	936	18.2	25
7½	YSC090F4*LA0000	11.2	89,000	96,000	80	41 x 53 x 89	33 x 17.5	32.13 x 17.5	916	19.5	30
7½	YSC092F4*LA0000	11.2	94,000	97,200	80	47 x 53 x 89	33 x 17.5	32.13 x 17.5	1059	21.5	25
8½	YSC102F4*LA0000	11.2	102,000	97,200	80	47 x 53 x 89	33 x 17.5	32.13 x 17.5	1096	21.9	25
10	YSC120F4*LA0000	11.3	118,000	121,500	80	47 x 53 x 89	33 x 17.5	32.13 x 17.5	1156	22.7	35
<b>YSC -575/3/60 – Three Phase – Low Heat</b>											
6	YSC072FW*LA0000	11.2	75,000	64,800	80	41 x 53 x 89	33 x 17.5	32.13 x 17.5	936	12.7	20
7½	YSC090FW*LA0000	11.2	89,000	96,000	80	41 x 53 x 89	33 x 17.5	32.13 x 17.5	916	14.7	20
7½	YSC092FW*LA0000	11.2	94,000	97,200	80	47 x 53 x 89	33 x 17.5	32.13 x 17.5	1059	15.0	20
8½	YSC102FW*LA0000	11.2	102,000	97,200	80	47 x 53 x 89	33 x 17.5	32.13 x 17.5	1096	17.5	20
10	YSC120FW*LA0000	11.3	118,000	121,500	80	47 x 53 x 89	33 x 17.5	32.13 x 17.5	1156	18.9	25
<b>YSC -208-230/3/60 – Three Phase – Medium Heat</b>											
6	YSC072F3*MA0000	11.2	75,000	97,200	80	41 x 53 x 89	33 x 17.5	32.13 x 17.5	936	36.5	50
7½	YSC090F3*MA0000	11.2	89,000	120,000	80	41 x 53 x 89	33 x 17.5	32.13 x 17.5	916	38.2	60
7½	YSC092F3*MA0000	11.2	94,000	121,500	80	47 x 53 x 89	33 x 17.5	32.13 x 17.5	1059	41.2	50
8½	YSC102F3*MA0000	11.2	102,000	121,500	80	47 x 53 x 89	33 x 17.5	32.13 x 17.5	1096	46.3	60
10	YSC120F3*MA0000	11.3	118,000	162,000	80	47 x 53 x 89	33 x 17.5	32.13 x 17.5	1156	49.6	60
<b>YSC -460/3/60 – Three Phase – Medium Heat</b>											
6	YSC072F4*MA0000	11.2	75,000	97,200	80	41 x 53 x 89	33 x 17.5	32.13 x 17.5	936	18.2	25
7½	YSC090F4*MA0000	11.2	89,000	120,000	80	41 x 53 x 89	33 x 17.5	32.13 x 17.5	916	19.5	30
7½	YSC092F4*MA0000	11.2	94,000	121,500	80	47 x 53 x 89	33 x 17.5	32.13 x 17.5	1059	21.5	25
8½	YSC102F4*MA0000	11.2	102,000	121,500	80	47 x 53 x 89	33 x 17.5	32.13 x 17.5	1096	21.9	25
10	YSC120F4*MA0000	11.3	118,000	162,000	80	47 x 53 x 89	33 x 17.5	32.13 x 17.5	1156	22.7	35
<b>YSC -575/3/60 – Three Phase – Medium Heat</b>											
6	YSC072FW*MA0000	11.2	75,000	97,200	80	41 x 53 x 89	33 x 17.5	32.13 x 17.5	936	12.7	20
7½	YSC090FW*MA0000	11.2	89,000	120,000	80	41 x 53 x 89	33 x 17.5	32.13 x 17.5	916	14.7	20
7½	YSC092FW*MA0000	11.2	94,000	121,500	80	47 x 53 x 89	33 x 17.5	32.13 x 17.5	1059	15.9	20
8½	YSC102FW*MA0000	11.2	102,000	121,500	80	47 x 53 x 89	33 x 17.5	32.13 x 17.5	1096	17.5	20
10	YSC120FW*MA0000	11.3	118,000	162,000	80	47 x 53 x 89	33 x 17.5	32.13 x 17.5	1156	18.9	25
<b>YSC -208-230/3/60 – Three Phase – High Heat</b>											
6	YSC072F3*HA0000	11.2	75,000	121,500	80	41 x 53 x 89	33 x 17.5	32.13 x 17.5	936	36.5	50
7½	YSC090F3*HA0000	11.2	89,000	160,000	80	41 x 53 x 89	33 x 17.5	32.13 x 17.5	916	38.2	60
7½	YSC092F3*HA0000	11.2	94,000	162,000	80	47 x 53 x 89	33 x 17.5	32.13 x 17.5	1059	41.2	50
8½	YSC102F3*HA0000	11.2	102,000	162,000	80	47 x 53 x 89	33 x 17.5	32.13 x 17.5	1096	46.3	60
10	YSC120F3*HA0000	11.3	118,000	205,500	80	47 x 53 x 89	33 x 17.5	32.13 x 17.5	1156	49.6	60
<b>YSC -460/3/60 – Three Phase – High Heat</b>											
6	YSC072F4*HA0000	11.2	75,000	121,500	80	41 x 53 x 89	33 x 17.5	32.13 x 17.5	936	18.2	25
7½	YSC090F4*HA0000	11.2	89,000	160,000	80	41 x 53 x 89	33 x 17.5	32.13 x 17.5	916	19.5	30
7½	YSC092F4*HA0000	11.2	94,000	162,000	80	47 x 53 x 89	33 x 17.5	32.13 x 17.5	1059	21.5	25
8½	YSC102F4*HA0000	11.2	102,000	162,000	80	47 x 53 x 89	33 x 17.5	32.13 x 17.5	1096	21.9	25
10	YSC120F4*HA0000	11.3	118,000	205,500	80	47 x 53 x 89	33 x 17.5	32.13 x 17.5	1156	22.7	35
<b>YSC -575/3/60 – Three Phase – High Heat</b>											
6	YSC072FW*HA0000	11.2	75,000	121,500	80	41 x 53 x 89	33 x 17.5	32.13 x 17.5	936	12.7	20
7½	YSC090FW*HA0000	11.2	89,000	160,000	80	41 x 53 x 89	33 x 17.5	32.13 x 17.5	916	14.7	20
7½	YSC092FW*HA0000	11.2	94,000	162,000	80	47 x 53 x 89	33 x 17.5	32.13 x 17.5	1059	15.9	20
8½	YSC102FW*HA0000	11.2	102,000	162,000	80	47 x 53 x 89	33 x 17.5	32.13 x 17.5	1096	17.5	20
10	YSC120FW*HA0000	11.3	118,000	205,500	80	47 x 53 x 89	33 x 17.5	32.13 x 17.5	1156	18.9	25

① Downflow Airflow/Horizontal Airflow

② SEER applies, 3-5 tons; EER applies 6-10 tons.

\* Digit 9-E=Electromechanical or R=ReliaTel™.

\*\* Information subject to change. Please confirm with current Product Data/Service Facts for current factory production.

For complete equipment / combination selections, installation instructions and warranty information, please refer to Product Data/Ratings and/or Installers Guides and Limited Warranty Handbooks.

Light Commercial  
Packaged Gas/Electric

# Packaged Gas/Electric Convertible 3-10 Tons (Model Digit Numbers)

Digit	Description	Order Number	Digit	Description	Order Number
1-8	<b>Main Assembly (see previous page)</b>		20	<b>Convenience Outlet</b>	
9	<b>Unit Controls</b>			No Convenience Outlet .....	0
	Electromechanical .....	E		Unpowered Convenience Outlet .....	A
	ReliaTel™ Micro-processor .....	R		Powered Convenience Outlet (three-phase only)⑨ .....	B
10	<b>Heating Capacity</b>		21	<b>Communications Options</b> ③	
	Low .....	L		No Communications Interface .....	0
	Medium .....	M		Novar 2024 Controls③⑩ .....	3
	High .....	H		Novar 3051 Controls without Zone Sensor③⑩ .....	4
	Low - Stainless Steel Heat Exchanger .....	X		Novar 3051 Controls Interface with DCV③⑩ .....	5
	Medium - Stainless Steel Heat Exchanger .....	Y		BACnet™ Communications Interface .....	6
	High - Stainless Steel Heat Exchanger .....	Z	22	<b>Refrigeration System Option</b>	
11	<b>Minor Design Sequence</b>			Standard Refrigeration System⑩ .....	0
	First Sequence .....	A		Dehumidification Option②②③③ .....	B
12-13	<b>Service Sequence</b>		23	<b>Refrigeration Controls</b>	
	First Sequence (Factory assigned) .....	*,*		<i>Note: Applicable to Digit 7 = E, F</i>	
14	<b>Fresh Air Selection</b>			No Refrigeration Control⑤ .....	0
	No Fresh Air .....	0		Frostat⑪⑲ .....	1
	Manual Outside Air Damper 0-50%④ .....	A		Crankcase Heater② .....	2
	Motorized Outside Air Damper 0-50%⑲ .....	B		Frostat⑪⑲ and Crankcase Heater② .....	3
	Economizer, Dry Bulb 0-100% without		24	<b>Smoke Detector</b> ⑰	
	Barometric Relief⑦ .....	C		No Smoke Detector .....	0
	Economizer, Dry Bulb 0-100% with Barometric Relief⑦ ...	D		Return Air Smoke Detector⑲⑳ .....	A
	Economizer, Reference Enthalpy 0-100% without			Supply Air Smoke Detector .....	B
	Barometric Relief③⑦ .....	E		Supply and Return Air Smoke Detectors⑲⑳ .....	C
	Economizer, Reference Enthalpy 0-100% with			Plenum Smoke Detector .....	D
	Barometric Relief③⑦ .....	F	25	<b>System Monitoring Controls</b>	
	Economizer, Comparative Enthalpy 0-100%			No Monitoring Control⑭ .....	0
	without Barometric Relief③⑦ .....	G		Clogged Filter Switch⑭ .....	1
	Economizer, Comparative Enthalpy 0-100%			Fan Failure Switch⑬ .....	2
	with Barometric Relief③⑦ .....	H		Discharge Air Sensing Tube⑭ .....	3
	Low Leak Economizer, Dry Bulb			Clogged Filter Switch and Fan Failure Switch⑭ .....	4
	with Barometric Relief .....	K		Clogged Filter Switch and Discharge Air Sensing Tube⑭ .....	5
	Low Leak Economizer, Comparative Enthalpy			Fan Failure Switch and Discharge Air Sensing Tube⑭ .....	6
	with Barometric Relief .....	M		Clogged Filter Switch, Fan Failure Switch and	
	Low Leak Economizer, Reference Enthalpy			Discharge Air Sensing Tube⑭ .....	7
	with Barometric Relief .....	P		Novar Return Air Sensor (NOVAR 2024)⑮⑳ .....	8
15	<b>Supply Fan/Drive Type/Motor</b>			Novar Zone Temp Sensor (NOVAR 3051)⑮⑳ .....	9
	Standard Drive⑥ .....	0		Condensate Drain Pan Overflow Switch .....	A
	Oversized Motor .....	1		Clogged Filter Switch⑭ and Condensate Drain	
	Optional Belt Drive Motor⑮ .....	2		Pan Overflow Switch .....	B
	Single Zone VAV⑲ .....	6		Fan Failure Switch⑬ and Condensate Drain	
	Multi-Speed Indoor Fan⑦ .....	7		Pan Overflow Switch .....	C
	VAV Supply Air Temperature Control Standard Motor③ .....	E		Discharge Air Sensing⑭ and Condensate Drain	
16	<b>Hinged Service Access/Filters</b>			Pan Overflow Switch .....	D
	Standard Panels/Standard Filters .....	0		Clogged Filter Switch⑭, Fan Failure Switch⑬	
	Hinged Access Panels/Standard Filters .....	A		and Condensate Drain Pan Overflow Switch .....	E
	Standard Panels/2" MERV 8 Filters .....	B		Clogged Filter Switch⑭, Discharge Air Sensing Tube⑭	
	Hinged Access Panels/2" MERV 8 Filters .....	C		and Condensate Drain Pan Overflow Switch .....	F
	Standard Panels/2" MERV 13 Filters .....	D		Fan Failure Switch, Discharge Air Sensing Tube⑭ and	
	Hinged Access Panels/2" MERV 13 Filters .....	E		Condensate Drain Pan Overflow Switch .....	G
17	<b>Condenser Coil Protection</b>			Clogged Filter Switch⑭, Fan Failure Switch⑬,	
	Standard Coil .....	0		Discharge Air Sensing⑭ and Condensate	
	Standard Coil with Hail Guard .....	1		Drain Pan Overflow Switch .....	H
	Black Epoxy Pre-Coated Condenser Coil⑳ .....	2	26	<b>System Monitoring Controls</b>	
	Black Epoxy Pre-Coated Condenser Coil with			No Monitoring Controls .....	0
	Hail Guard⑳ .....	3		Demand Control Ventilation (CO <sub>2</sub> )③⑳ .....	A
	CompleteCoat™ Condenser Coil .....	4		Fault Detection and Diagnostics (FDD) .....	B
	CompleteCoat™ Condenser Coil with Hail Guard .....	5		Fault Detection and Diagnostics (FDD)	
18	<b>Through the Base Provisions</b>			with Demand Control Ventilation .....	C
	<i>Note: Applicable to Digit 1, T or Y models</i>		27	<b>Unit Hardware Enhancements</b>	
	No Through-the-Base Provisions .....	0		No Enhancements .....	0
	Through-the-Base Electric⑥ .....	A		Stainless Steel Drain Pan .....	1
	<i>Note: Applicable to Digit 1, Y models only</i>		31	<b>Advanced Unit Controls</b>	
	Through-the-Base Gas Piping⑥ .....	B		Standard Unit Controls .....	0
	Through-the-Base Electric and Gas Piping⑥ .....	C		Human Interface .....	1
19	<b>Disconnect/Circuit Breaker (three-phase only)</b>				
	No Disconnect/No Circuit Breaker .....	0			
	Unit Mounted Non-Fused Disconnect③ .....	1			
	Unit Mounted Circuit Breaker③ .....	2			

See Footnotes ①-③ next page.

For complete equipment / combination selections, installation instructions and warranty information, please refer to Product Data/Ratings and/or Installers Guides and Limited Warranty Handbooks.

# Packaged Gas/Electric Convertible 3-10 Tons (Model Digit Numbers)

- ① Available on 3-5 Ton models.
- ② Standard on 4-5 Ton E3,4,W and 6-10 Ton Heat Pumps and all High Efficiency models.
- ③ Not available with electromechanical controls.
- ④ Manual outside air damper will ship factory supplied within the unit, but must be field installed.
- ⑤ High pressure control is standard on all units.
- ⑥ On 3-5 ton, multispeed direct drive is standard on single phase and 15 SEER. On 6-10 ton, multispeed direct drive is standard on all 10 ton and 7.5-8.5 ton high efficiency. Belt drive is standard on all other units.
- ⑦ Economizer with Barometric Relief is for downflow configured units only. Order Economizer without Barometric Relief for horizontal configuration. Barometric Relief for horizontal configured units must be ordered as field installed accessory.
- ⑧ Through the base electric required when ordering disconnect/circuit breaker options.
- ⑨ Requires use of Disconnect or Circuit Breaker.

## Digit 15 = 0

### Standard Efficiency

- 1 Phase = High Efficiency Multispeed Direct Drive Motor
- 3 Phase (3-8½ Ton) = Belt Drive
- 3 Phase (10 Ton) = Ultra High Efficiency Direct Drive Plenum Fan

### High Efficiency

- 1 Phase = High Efficiency Multispeed Direct Drive Motor
- 3 Phase (3-5 ton) = High Efficiency Multispeed Direct Drive Motor
- 3 Phase (3-5 ton w/Dehumidification) = Belt Drive Motor
- 3 Phase (7½-10 ton) = Ultra High Efficiency Direct Drive Plenum Fan

### Not Available

Standard Efficiency: 10 Ton w/575V

High Efficiency: 3-5 ton w/Standard Indoor Motor w/460V

- ⑩ Standard metering devices are TXVs.
- ⑪ Froststat cannot be field installed in electro-mechanical units.
- ⑫ The return air smoke detector may not fit up or work properly on the Precedent units when used in conjunction with 3rd party accessories such as bolt on heat wheels, economizers and power exhaust. Do not order the return air smoke detectors when using this type of accessory.
- ⑬ Return Air Smoke Detector cannot be ordered with Novar Controls.
- ⑭ These options are standard when ordering Novar Controls.
- ⑮ This option is used when ordering Novar Controls.
- ⑯ Includes gas piping and shutoff (field assembly required).
- ⑰ Not available with high temperature duct sensor accessory.
- ⑱ Digit 15 = 2
- ⑲ Novar Sensor utilized with Digit 21 = (4) Novar 3051 Controls without Zone Sensor.
- ⑳ Available for T/Y 10 ton standard efficiency models only.
- ㉑ Available for T/Y 3, 4, 5, 6, 7½, 8½ ton standard/high efficiency models only.
- ㉒ Requires selection of 2" Pleated Filters (option B or C) for Digit 16.
- ㉓ Not available on 6 ton units and all single phase or standard efficiency.
- ㉔ Standard on T/YSC 6, 7½ (single and dual systems), 8½, 10 ton standard efficiency models and T/YHC 4, 5, 6, 7½ ton high efficiency models (except for dehumidification models).
- ㉕ Epoxy coil and epoxy with hailguard options are not available for units with microchannel condenser coil.
- ㉖ Single Zone VAV is only available on 7.5-10 ton high efficiency and 10 ton standard efficiency products with ReliaTel™ controls.
- ㉗ Multi-speed indoor fan available only on 7.5 & 8.5 ton high efficiency, and 10 ton products with ReliaTel™ controls.
- ㉘ Motorized Outside Air Damper is not available on Multi-Speed or SZVAV (Single Zone Variable Air Volume) products.
- ㉙ Froststat standard on Multi-Speed and SZVAV (Single Zone Variable Air Volume) products.
- ㉚ Novar is not available with SZVAV products.
- ㉛ Demand Control Ventilation not available with electromechanical controls.
- ㉜ Demand Control Ventilation Option includes wiring only. The CO<sub>2</sub> sensor is a field-installed only option.
- ㉝ When ordering Dehumidification option, digit #7 will revert back to E, not F.

# Packaged Gas/Electric Convertible 3-10 Tons Accessories

**Table LPG-11-A — Accessories**

Model Number	Description	Used With <sup>①</sup>
BAYABRD001C <sup>③</sup>	ReliaTel™ Options Module.....	All Y*C036-120*
BAYASCT001C <sup>⑦⑧</sup>	Anti-Short-Cycle Timer.....	All Y*C036-120* w/ Electro Mechanical
BAYBARM010A <sup>⑨</sup>	Barometric Relief .....	YSC036E, YHC036E, YHC037E
BAYBARM011A <sup>⑨</sup>	Barometric Relief .....	YSC048E-120E, YHC048-120, YHC047-067
BAYBCIR001A.....	BACnet™ Communication Interface .....	All Y*C036-120* w/ ReliaTel™
BAYCCHT010B.....	Crankcase Heater .....	YSC036-048, YSC092-102
BAYCCHT011B.....	Crankcase Heater .....	YSC036-048, YSC092-102
BAYCCHT017A.....	Crankcase Heater .....	YSC060-072, YSC090, YSC120
BAYCCHT018A.....	Crankcase Heater .....	YSC060-072, YSC090, YSC120
BAYCURB042A <sup>②</sup>	Roof Curb.....	YSC036-060E, YSC036-060F, YHC036E, YHC037E
BAYCURB043A <sup>②</sup>	Roof Curb.....	YSC 072-120E, YSC072-120F, YHC072F, YHC047E, YHC067E
BAYCURB044A.....	Roof Curb.....	YHC120F
BAYDFPS003B <sup>③⑥</sup>	Clogged Filter Switch.....	All Y*C036-120*
BAYDFPS014A.....	Clogged Filter Switch (MERV 13 Filter) .....	All Y*C036-120*
BAYDFPS004 <sup>③⑥</sup>	Fan Failure Switch.....	All Y*C036-120*
BAYDMPR053A <sup>⑩</sup>	0-50% Manual Outside Air Damper .....	YSC036-060, YHC036, YHC037
BAYDMPR056B <sup>⑩</sup>	0-50% Manual Outside Air Damper .....	YSC072-120, YHC048-060, YHC047-067
BAYDMPR051A <sup>③</sup>	0-50% Motorized Outside Air Damper .....	YSC036-060, YHC036, YHC037 (ReliaTel™)
BAYDMPR052A <sup>⑦</sup>	0-50% Motorized Outside Air Damper .....	YSC036-060, YHC036 (Electro Mechanical)
BAYDMPR054A <sup>③</sup>	0-50% Motorized Outside Air Damper .....	YSC072-120, YHC048-060, YHC047-067 (ReliaTel™)
BAYDMPR055A <sup>⑦</sup>	0-50% Motorized Outside Air Damper .....	YHC048-060, YSC072-120, YHC072-120 (Electro Mechanical)
BAYECON085A <sup>③</sup>	0-100% Dry Bulb Economizer.....	YSC036-060, YHC036, YHC037 (ReliaTel™)
BAYECON086A <sup>⑦</sup>	0-100% Dry Bulb Economizer .....	YSC036-060, YHC036 (Electro Mechanical)
	without Barometric Relief	
BAYECON087A <sup>③</sup>	0-100% Dry Bulb Economizer .....	YSC072-120, YHC048-060, YHC047-067 (ReliaTel™)
BAYECON088A <sup>⑦</sup>	0-100% Dry Bulb Economizer .....	YHC048-060, YSC072-120, YHC072-120 (Electro Mechanical)
BAYECON704A.....	Downflow Low Leak Economizer .....	YHC047E-067E*R, YHC048-060E*R, YHC072-102F*R, YHC120E*R, YSC(072-120)F*R, YHC048-060F*R, YHC048E-120E*E, YSC(072-120)F*E, YHC(048-060)F*E, YHC092F*E (ReliaTel™)
BAYECON705A.....	Downflow Low Leak Economizer .....	YSC036-060E*R, YHC036E*R, YHC037E*R, YHC036E*E, YSC036-060E*E (ReliaTel™)
BAYENTH300A.....	Reference Enthalpy Kit (Solid State).....	BAYECON086A, 088A (Electro-Mechanical)
BAYENTH301A.....	Comparative Enthalpy Kit (Solid State).....	BAYECON086A, 088A (Electro-Mechanical)
BAYENTH005A <sup>①</sup>	Reference Enthalpy Kit.....	BAYECON085A, 087A (ReliaTel™)
BAYENTH006A <sup>①</sup>	Comparative Enthalpy Kit.....	BAYECON086A, 087A (ReliaTel™)
BAYFRST003A <sup>③④</sup>	High Temperature Stat .....	All Y*C036-120*
BAYGARD037B.....	Condenser Coil Hail Guard.....	YSC036-60E, YHC037
BAYGARD040A.....	Condenser Coil Hail Guard.....	YSC072E-090E, YHC048-060, YHC047-067
BAYGARD041A.....	Condenser Coil Hail Guard.....	YSC092-120, YHC072
BAYGARD070A.....	Condenser Coil Hail Guard.....	YHC120E
BAYGARD141A.....	Condenser Coil Hail Guard.....	YSC102F-120F, YHC072F-102F
BAYHAKT010C.....	High Altitude Kit .....	All Y*C036-120*

① Kits contain all necessary parts to achieve desired level of enthalpy control.  
 ② Lynn Haven Manufacturing has a No-Return policy for this roof curb.  
 ③ For use with ReliaTel™ controlled units only.  
 ④ Cannot be used in conjunction with factory installed Smoke Detector option.  
 ⑤ Installs in ductwork for horizontal configuration. For downflow configuration, it installs in the unit's horizontal return duct. See Installer's Guide for more information.  
 ⑥ BAYABRD001C is required when ordering field installed accessories Clogged Filter Switch (BAYDFPS003A), Fan Fail Switch (BAYDFPS004A), Discharge Air Sensing Kit (BAYTUBE004A or BAYTUBE005A) or Evaporator Defrost Control (Frostat) (BAYLOAM020B) Ventilation Override Kit (BAYVNOR001B) unless the following options are factory installed: Frostat, Smoke Detector, Clogged Filter Switch, Fan Failure Switch, Discharge Air Sensing Kit. **These factory installed options include the ReliaTel™ Options Module.**  
 ⑦ Electromechanical controlled units only  
 ⑧ Activated on Power on.  
 ⑨ Field installed accessory. Requires an economizer.  
 ⑩ The manual outside air damper will ship factory supplied within the unit, but must be field installed.  
 ⑪ A=R-22, E=410A

For complete equipment / combination selections, installation instructions and warranty information, please refer to Product Data/Ratings and/or Installers Guides and Limited Warranty Handbooks.

# Packaged Gas/Electric Convertible 3-10 Tons Accessories

**Table LPG-12-A — Accessories**

Model Number	Description	Used With <sup>Ⓢ</sup>
BAYHSMT082A	2 HP Oversized motor kit (208-230/460V)	YSC072F3, 4
BAYHSMT083A	2 HP Oversized motor kit (575V)	YSC072FW
BAYHSMT402A	2 HP Oversized motor kit	YHC072F3, 4
BAYHSMT086A	3 HP Oversized motor kit (208-230/460V)	YSC090-102F3, 4
BAYHSMT087A	3 HP Oversized motor kit (575V)	YSC090-102FW
BAYLSDR009A	Low Static Drive Kit	YHC072F
BAYHSDR012A	High Static Drive Kit	YSC072F
BAYKSKT255B	Quick Start Kit	YSC036-060*1
BAYLMSW001A <sup>Ⓣ</sup>	Power Exhaust Limit Switch	All Y*C036-120*
BAYLOAM020B <sup>Ⓛ</sup> <sup>Ⓟ</sup>	Evaporator Defrost Control (Frostat)	All Y*C036-120*, R (ReliaTel™)
BAYLPKT029C	LP Conversion Kit	YSC072*,H, YSC090-102,M,H, YSC120,L,M,H YHC072*,H, YHC092-102*,M,H, YHC120*,L,M,H
BAYLPKT050B	LP Conversion Kit	YSC036-060*,L,M,H, YSC072*,L,M, YSC090-102*,L YHC036-060*,L,M,H, YHC072*,L,M, YHC092-102*,L
BAYPWRX070A	Power Exhaust (208-230/3 VAC)	YSC036-060*3, YCH036-YHC060*3, YHC037E3, YHC047E3, YHC067E3
BAYPWRX071A	Power Exhaust (460/3 VAC)	YSC036-060*4, YHC036-YHC060*4, YHC037E4, YHC047E4, YHC067E4
BAYPWRX072A	Power Exhaust (575/3 VAC)	YSC036-060*W
BAYPWRX026A	Power Exhaust (208-230/3 VAC)	YSC072-102F3, YSC120F3, YHC072F3, YHC092F3, YHC102F3, YHC120E3
BAYPWRX027A	Power Exhaust (460/3 VAC)	YSC072-102F4, YSC120F4, YHC072F4, YHC092F4, YHC102F4, YHC120E4
BAYPWRX028A	Power Exhaust (575/3 VAC)	YSC072-102FW, YSC120FW
BAYQACB009A	Quick Adapt Roof Curb	YSC036-060*, YHC036E, YHC037E
BAYQACB010A	Quick Adapt Roof Curb	YSC036-060*, YHC036E, YHC037E
BAYQACB011A	Quick Adapt Roof Curb	YSC072-102F, YSC120F, YHC048-072F, YHC047E, YHC067E
BAYQACB012A	Quick Adapt Roof Curb	YSC072-102F, YSC120F, YHC048-072F, YHC047E, YHC067E
BAYQACB013A	Quick Adapt Roof Curb	YSC072-102F, YSC120F, YHC048-072F, YHC047E, YHC067E
BAYRTEM001A <sup>Ⓣ</sup>	Fully Featured ReliaTel™ Economizer Logic Model	All Y*C036-120*
BAYSENS016A <sup>④</sup>	Temperature Sensor	All Y*C036-120*
BAYSENS250A <sup>③</sup> <sup>②</sup>	CO <sub>2</sub> Duct Mounted, Sensor Only	All Y*C036-120*, R (ReliaTel™)
BAYSENS251A <sup>③</sup> <sup>②</sup>	CO <sub>2</sub> Wall Mounted, Sensor Only	All Y*C036-120*, R (ReliaTel™)
BAYSERV001A <sup>④</sup>	Selective Resistance Service Tester	All Y*C036-120*
BAYSTAT023 <sup>④</sup>	Remote Potentiometer	All Y*C036-120*
BAYTUBE004A <sup>④</sup> <sup>②</sup> <sup>⑤</sup>	Discharge Air Sensing Kit	YSC036-060*, R, YHC036E, R
BAYTUBE006A <sup>④</sup> <sup>②</sup> <sup>⑤</sup>	Discharge Air Sensing Kit	YSC072-102F, R, YHC048-072F, R
BAYTUBE400A	Discharge Air Sensing Kit	YSC120F,R
BAYTUBE402A	Discharge Air Sensing Kit	YHC092-120*,R
BAYVNOR001B <sup>④</sup> <sup>③</sup> <sup>⑤</sup>	Ventilation Override Kit	All Y*C036-120*

① For use with ReliaTel™ microprocessor controlled units only. Must be factory installed for Electromechanical controlled units.

② Used for true discharge air sensing in both heating and cooling. Required for supply air tempering.

③ Lynn Haven Manufacturing has a No-Return policy for this roof curb.

④ For use with ReliaTel™ controlled units only.

⑤ BAYABRD001C is required when ordering field installed accessories Clogged Filter Switch (BAYDFPS003A), Fan Fail Switch (BAYDFPS004A), Discharge Air Sensing Kit (BAYTUBE004A or BAYTUBE005A) or Evaporator Defrost Control (Frostat) (BAYLOAM020B) Ventilation Override Kit (BAYVNOR001B) unless the following options are factory installed: Frostat, Smoke Detector, Clogged Filter Switch, Fan Failure Switch, Discharge Air Sensing Kit. **These factory installed options include the ReliaTel™ Options Module.**

⑥ BAYQACB009A adapts YCD units BAYCURB021B to accept Y\*C 3 -5 ton unit. BAYQACB010A adapts YCD units BAYCURB022B to accept Y\*C 3-5 ton unit.

BAYQACB012A adapts YCD units BAYCURB025B to accept Y\*C 3-5 ton unit. BAYQACB013A adapts YCD units BAYCURB026B to accept Y\*C 6-10 ton unit.

BAYQACB011A adapts YCD units BAYCURB022B to accept Y\*C 6-10 ton unit.

⑦ Power Exhaust cannot be used with Barometric Relief. Order Economizer without Barometric Relief.

⑧ Field installed accessory. Requires an economizer.

⑨ E=410A

⑩ When ordering a field installed power exhaust on a unit with electromechanical controls, BAYLMSW001A must be ordered.

⑪ If any version of comparative or reference enthalpy is ordered, BAYRTEM001A does not need to be ordered.

⑫ Order only when unit has factory installed Demand Control Ventilation option.

For complete equipment / combination selections, installation instructions and warranty information, please refer to Product Data/Ratings and/or Installers Guides and Limited Warranty Handbooks.

# Packaged Gas/Electric Convertible 3-10 Tons, R-410A Zone Sensors / Thermostats

**Table LPG-13-A — Zone Sensors for ReliaTel™ Controlled Units**

Model Number	Description	Used With
ASYSTAT106A	Single Setpoint Manual Changeover	Y*C036-120*, R
ASYSTAT107A	Single Setpoint	Y*C036-120*, R
ASYSTAT108A	Dual Setpoint Manual or Auto Changeover	Y*C036-120*, R
ASYSTAT109A	Dual Setpoint Changeover Sensor	Y*C036-120*, R
ASYSTAT111A	Remote Room Sensor	Y*C036*120*, R
ASYSTAT777A	Programmable Night Setback w/System Function Lights (Vertical Style)	Y*C036-120*, R
ASYSTAT708A	Programmable Night Setback w/System Function Lights	Y*C036-120*, R
ASYSTAT710A	Wall Mounted Humidity Sensor	Y*C036-120*
ASYSTAT711A	Duct Mounted Humidity Sensor	Y*C036-120*
BAYMTPL110A	Retrofit Wall Cover Plate Kit 7.25" x 6.0"	ASYSTAT666C

**For additional Controls Information:  
See ReliaTel™ and Micro Control features on LPC-14 and LPC-15.**

For complete equipment / combination selections, installation instructions and warranty information, please refer to Product Data/Ratings and/or Installers Guides and Limited Warranty Handbooks.

# Packaged Gas/Electric with ReliaTel™ Controls 12½-25 Tons, R-410A

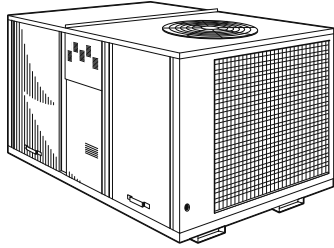

**12½ - 25 Ton YHD-F — Downflow**  
**12½ - 25 Ton YHH-F — Horizontal**

- Scroll compressors on all units
- **ReliaTel™** control features are listed on page LPC-14
- Operating charge of R-410A
- Built-in anti-short cycle timer, time delay relay and minimum on time controls
- Low Ambient to 0°F standard
- High efficiency drum and tube heat exchanger (20 - 25 tons)
- Color coded and numbered wiring
- 2" throwaway filters
- Simple U-shaped airflow pattern results in very low airside energy requirement
- Quick-Access doors and single side access

- make servicing much faster for lower maintenance costs
- Quick-adjust idler arm pulley. Adjust belt tension, change belts, adjust airflow quickly
- High efficiency gas heat with hot surface ignition for low heating energy costs, low maintenance and high reliability
- Sloped sheet metal drain pans
- **5-year limited compressor warranty (12 ½ - 25 tons)**
- **5-year limited heat exchanger warranty (12 ½ - 17 ½ tons)**
- **1-year limited warranty (20 - 25 tons)**

**Table LPG-14-A — High Efficiency ReliaTel™ Units (R-410A)**

Tons	Unit Model No.	Power Supply Volts/Phase/Hz	Performance EER <sup>③</sup>	Cooling Capacity (Btuh)	Heating Output Capacity (Btuh)	Dimensions (in.) H x W x L	Shipping Weight (lbs.)	MCA**	Max Fuse Size or Max Circuit Breaker**	Downflow <sup>①</sup> Roofcurb
<b>YH* - Three Phase Low Heat</b>										
12½	YH*150F3RLA0000	208-230/3/60	12.1	140,000	122,000	54 x 85 <sup>5</sup> / <sub>16</sub> x 122 <sup>5</sup> / <sub>16</sub>	2550	65	80	BAYCURB027B
15	YH*180F3RLA0000	208-230/3/60	12.0	172,000	203,000	64 <sup>1</sup> / <sub>8</sub> x 85 <sup>5</sup> / <sub>16</sub> x 122 <sup>5</sup> / <sub>16</sub>	2500	72	90	BAYCURB027B
17½	YH*210F3RLA0000	208-230/3/60	11.8	198,000	203,000	64 <sup>1</sup> / <sub>8</sub> x 85 <sup>5</sup> / <sub>16</sub> x 122 <sup>5</sup> / <sub>16</sub>	2578	88	110	BAYCURB027B
20	YH*240F3RLA0000	208-230/3/60	11.0	242,000	203,000	64 <sup>1</sup> / <sub>8</sub> x 85 <sup>5</sup> / <sub>16</sub> x 122 <sup>5</sup> / <sub>16</sub>	2581	104	125	BAYCURB027B
25	YH*300F3RLA0000	208-230/3/60	10.6	272,000 <sup>②</sup>	203,000	64 <sup>1</sup> / <sub>8</sub> x 85 <sup>5</sup> / <sub>16</sub> x 122 <sup>5</sup> / <sub>16</sub>	2544	116	150	BAYCURB027B
12½	YH*150F4RLA0000	460/3/60	12.1	140,000	122,000	54 x 85 <sup>5</sup> / <sub>16</sub> x 122 <sup>5</sup> / <sub>16</sub>	2550	32	40	BAYCURB027B
15	YH*180F4RLA0000	460/3/60	12.0	172,000	203,000	64 <sup>1</sup> / <sub>8</sub> x 85 <sup>5</sup> / <sub>16</sub> x 122 <sup>5</sup> / <sub>16</sub>	2500	36	45	BAYCURB027B
17½	YH*210F4RLA0000	460/3/60	11.8	198,000	203,000	64 <sup>1</sup> / <sub>8</sub> x 85 <sup>5</sup> / <sub>16</sub> x 122 <sup>5</sup> / <sub>16</sub>	2578	42	50	BAYCURB027B
20	YH*240F4RLA0000	460/3/60	11.0	242,000	203,000	64 <sup>1</sup> / <sub>8</sub> x 85 <sup>5</sup> / <sub>16</sub> x 122 <sup>5</sup> / <sub>16</sub>	2581	50	60	BAYCURB027B
25	YH*300F4RLA0000	460/3/60	10.6	272,000 <sup>②</sup>	203,000	64 <sup>1</sup> / <sub>8</sub> x 85 <sup>5</sup> / <sub>16</sub> x 122 <sup>5</sup> / <sub>16</sub>	2544	56	70	BAYCURB027B
12½	YH*150FWRLA0000	575/3/60	12.1	140,000	122,000	54 x 85 <sup>5</sup> / <sub>16</sub> x 122 <sup>5</sup> / <sub>16</sub>	2550	25	30	BAYCURB027B
15	YH*180FWRLA0000	575/3/60	12.0	172,000	203,000	64 <sup>1</sup> / <sub>8</sub> x 85 <sup>5</sup> / <sub>16</sub> x 122 <sup>5</sup> / <sub>16</sub>	2500	29	40	BAYCURB027B
17½	YH*210FWRLA0000	575/3/60	11.8	198,000	203,000	64 <sup>1</sup> / <sub>8</sub> x 85 <sup>5</sup> / <sub>16</sub> x 122 <sup>5</sup> / <sub>16</sub>	2578	36	45	BAYCURB027B
20	YH*240FWRLA0000	575/3/60	11.0	242,000	203,000	64 <sup>1</sup> / <sub>8</sub> x 85 <sup>5</sup> / <sub>16</sub> x 122 <sup>5</sup> / <sub>16</sub>	2581	42	50	BAYCURB027B
25	YH*300FWRLA0000	575/3/60	10.6	272,000 <sup>②</sup>	203,000	64 <sup>1</sup> / <sub>8</sub> x 85 <sup>5</sup> / <sub>16</sub> x 122 <sup>5</sup> / <sub>16</sub>	2544	47	60	BAYCURB027B
<b>YH* - Three Phase High Heat</b>										
12½	YH*150F3RHA0000	208-230/3/60	12.1	140,000	203,000	54 x 85 <sup>5</sup> / <sub>16</sub> x 122 <sup>5</sup> / <sub>16</sub>	2550	65	80	BAYCURB027B
15	YH*180F3RHA0000	208-230/3/60	12.0	172,000	284,000	64 <sup>1</sup> / <sub>8</sub> x 85 <sup>5</sup> / <sub>16</sub> x 122 <sup>5</sup> / <sub>16</sub>	2500	72	90	BAYCURB027B
17½	YH*210F3RHA0000	208-230/3/60	11.8	198,000	284,000	64 <sup>1</sup> / <sub>8</sub> x 85 <sup>5</sup> / <sub>16</sub> x 122 <sup>5</sup> / <sub>16</sub>	2578	88	110	BAYCURB027B
20	YH*240F3RHA0000	208-230/3/60	11.0	242,000	324,000	64 <sup>1</sup> / <sub>8</sub> x 85 <sup>5</sup> / <sub>16</sub> x 122 <sup>5</sup> / <sub>16</sub>	2581	104	125	BAYCURB027B
25	YH*300F3RHA0000	208-230/3/60	10.6	272,000	324,000	64 <sup>1</sup> / <sub>8</sub> x 85 <sup>5</sup> / <sub>16</sub> x 122 <sup>5</sup> / <sub>16</sub>	2544	116	150	BAYCURB027B
12½	YH*150F4RHA0000	460/3/60	12.1	140,000	203,000	54 x 85 <sup>5</sup> / <sub>16</sub> x 122 <sup>5</sup> / <sub>16</sub>	2550	32	40	BAYCURB027B
15	YH*180F4RHA0000	460/3/60	12.0	172,000	284,000	64 <sup>1</sup> / <sub>8</sub> x 85 <sup>5</sup> / <sub>16</sub> x 122 <sup>5</sup> / <sub>16</sub>	2500	36	45	BAYCURB027B
17½	YH*210F4RHA0000	460/3/60	11.8	198,000	284,000	64 <sup>1</sup> / <sub>8</sub> x 85 <sup>5</sup> / <sub>16</sub> x 122 <sup>5</sup> / <sub>16</sub>	2578	42	50	BAYCURB027B
20	YH*240F4RHA0000	460/3/60	11.0	242,000	324,000	64 <sup>1</sup> / <sub>8</sub> x 85 <sup>5</sup> / <sub>16</sub> x 122 <sup>5</sup> / <sub>16</sub>	2581	50	60	BAYCURB027B
25	YH*300F4RHA0000	460/3/60	10.6	272,000	324,000	64 <sup>1</sup> / <sub>8</sub> x 85 <sup>5</sup> / <sub>16</sub> x 122 <sup>5</sup> / <sub>16</sub>	2544	56	70	BAYCURB027B
12½	YH*150FWRHA0000	575/3/60	12.1	140,000	203,000	54 x 85 <sup>5</sup> / <sub>16</sub> x 122 <sup>5</sup> / <sub>16</sub>	2550	25	30	BAYCURB027B
15	YH*180FWRHA0000	575/3/60	12.0	172,000	284,000	64 <sup>1</sup> / <sub>8</sub> x 85 <sup>5</sup> / <sub>16</sub> x 122 <sup>5</sup> / <sub>16</sub>	2500	29	40	BAYCURB027B
17½	YH*210FWRHA0000	575/3/60	11.8	198,000	284,000	64 <sup>1</sup> / <sub>8</sub> x 85 <sup>5</sup> / <sub>16</sub> x 122 <sup>5</sup> / <sub>16</sub>	2578	36	45	BAYCURB027B
20	YH*240FWRHA0000	575/3/60	11.0	242,000	324,000	64 <sup>1</sup> / <sub>8</sub> x 85 <sup>5</sup> / <sub>16</sub> x 122 <sup>5</sup> / <sub>16</sub>	2581	42	50	BAYCURB027B
25	YH*300FWRHA0000	575/3/60	10.6	272,000	324,000	64 <sup>1</sup> / <sub>8</sub> x 85 <sup>5</sup> / <sub>16</sub> x 122 <sup>5</sup> / <sub>16</sub>	2544	47	60	BAYCURB027B

① For Downflow units only.

② 278,000 in the Horizontal airflow configuration.

③ Downflow/Horizontal

\* Digit 3 D=Downflow or H=Horizontal.

\*\* Information subject to change. Please confirm with current Product Data/Service Facts for current factory production.



# Packaged Gas/Electric with ReliaTel™ Controls 12½-25 Tons, R-410A

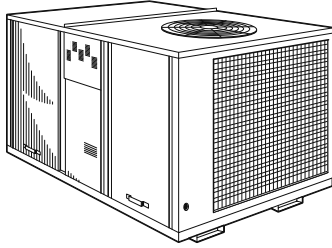

**12½ - 25 Ton YHD-F — Downflow**  
**12½ - 25 Ton YHH-F — Horizontal**

- Scroll compressors on all units
  - ReliaTel™ control features are listed on page LPC-14
  - Operating charge of R-410A
  - Built-in anti-short cycle timer, time delay relay and minimum on time controls
  - Low Ambient to 0°F standard
  - High efficiency drum and tube heat exchanger (20 - 25 tons)
  - Color coded and numbered wiring
  - 2" throwaway filters
  - Simple U-shaped airflow pattern results in very low airside energy requirement
  - Quick-Access doors and single side access
- make servicing much faster for lower maintenance costs
  - Quick-adjust idler arm pulley. Adjust belt tension, change belts, adjust airflow quickly
  - High efficiency gas heat with hot surface ignition for low heating energy costs, low maintenance and high reliability
  - Sloped sheet metal drain pans
  - **5-year limited compressor warranty (12½ - 25 tons)**
  - **5-year limited heat exchanger warranty (12½ - 17½ tons)**
  - **1-year limited warranty (20 - 25 tons)**

**Table LPG-15-A —High Efficiency ReliaTel™ Units (R-410A) - Multi Speed Indoor Fan**

Tons	Unit Model No.	Power Supply Volts/Phase/Hz	Performance EER <sup>③</sup>	Cooling Capacity (Btuh)	Heating Output Capacity (Btuh)	Dimensions (in.) H x W x L	Shipping Weight (lbs.)	MCA**	Max Fuse Size or Max Circuit Breaker**	Downflow <sup>①</sup> Roofcurb
<b>YH* - Three Phase Low Heat</b>										
12½	YH*150F3RLA1B8B	208-230/3/60	12.1	140,000	122,000	54 x 85 <sup>5</sup> / <sub>16</sub> x 122 <sup>5</sup> / <sub>16</sub>	2575	65	80	BAYCURB027B
15	YH*180F3RLA1B8B	208-230/3/60	12.0	172,000	203,000	64 <sup>1</sup> / <sub>8</sub> x 85 <sup>5</sup> / <sub>16</sub> x 122 <sup>5</sup> / <sub>16</sub>	2525	72	90	BAYCURB027B
17½	YH*210F3RLA1B8B	208-230/3/60	11.8	198,000	203,000	64 <sup>1</sup> / <sub>8</sub> x 85 <sup>5</sup> / <sub>16</sub> x 122 <sup>5</sup> / <sub>16</sub>	2603	88	110	BAYCURB027B
20	YH*240F3RLA1B8B	208-230/3/60	11.0	242,000	203,000	64 <sup>1</sup> / <sub>8</sub> x 85 <sup>5</sup> / <sub>16</sub> x 122 <sup>5</sup> / <sub>16</sub>	2606	104	125	BAYCURB027B
25	YH*300F3RLA1B8B	208-230/3/60	10.6	272,000 <sup>②</sup>	203,000	64 <sup>1</sup> / <sub>8</sub> x 85 <sup>5</sup> / <sub>16</sub> x 122 <sup>5</sup> / <sub>16</sub>	2609	116	150	BAYCURB027B
12½	YH*150F4RLA1B8B	460/3/60	12.1	140,000	122,000	54 x 85 <sup>5</sup> / <sub>16</sub> x 122 <sup>5</sup> / <sub>16</sub>	2575	32	40	BAYCURB027B
15	YH*180F4RLA1B8B	460/3/60	12.0	172,000	203,000	64 <sup>1</sup> / <sub>8</sub> x 85 <sup>5</sup> / <sub>16</sub> x 122 <sup>5</sup> / <sub>16</sub>	2525	36	45	BAYCURB027B
17½	YH*210F4RLA1B8B	460/3/60	11.8	198,000	203,000	64 <sup>1</sup> / <sub>8</sub> x 85 <sup>5</sup> / <sub>16</sub> x 122 <sup>5</sup> / <sub>16</sub>	2603	42	50	BAYCURB027B
20	YH*240F4RLA1B8B	460/3/60	11.0	242,000	203,000	64 <sup>1</sup> / <sub>8</sub> x 85 <sup>5</sup> / <sub>16</sub> x 122 <sup>5</sup> / <sub>16</sub>	2606	50	60	BAYCURB027B
25	YH*300F4RLA1B8B	460/3/60	10.6	272,000 <sup>②</sup>	203,000	64 <sup>1</sup> / <sub>8</sub> x 85 <sup>5</sup> / <sub>16</sub> x 122 <sup>5</sup> / <sub>16</sub>	2589	56	70	BAYCURB027B
12½	YH*150FWRLA1B8B	575/3/60	12.1	140,000	122,000	54 x 85 <sup>5</sup> / <sub>16</sub> x 122 <sup>5</sup> / <sub>16</sub>	2575	25	30	BAYCURB027B
15	YH*180FWRLA1B8B	575/3/60	12.0	172,000	203,000	64 <sup>1</sup> / <sub>8</sub> x 85 <sup>5</sup> / <sub>16</sub> x 122 <sup>5</sup> / <sub>16</sub>	2525	29	40	BAYCURB027B
17½	YH*210FWRLA1B8B	575/3/60	11.8	198,000	203,000	64 <sup>1</sup> / <sub>8</sub> x 85 <sup>5</sup> / <sub>16</sub> x 122 <sup>5</sup> / <sub>16</sub>	2603	36	45	BAYCURB027B
20	YH*240FWRLA1B8B	575/3/60	11.0	242,000	203,000	64 <sup>1</sup> / <sub>8</sub> x 85 <sup>5</sup> / <sub>16</sub> x 122 <sup>5</sup> / <sub>16</sub>	2606	42	50	BAYCURB027B
25	YH*300FWRLA1B8B	575/3/60	10.6	272,000 <sup>②</sup>	203,000	64 <sup>1</sup> / <sub>8</sub> x 85 <sup>5</sup> / <sub>16</sub> x 122 <sup>5</sup> / <sub>16</sub>	2589	47	60	BAYCURB027B
<b>YH* - Three Phase High Heat</b>										
12½	YH*150F3RHA1B8B	208-230/3/60	12.1	140,000	203,000	54 x 85 <sup>5</sup> / <sub>16</sub> x 122 <sup>5</sup> / <sub>16</sub>	2575	65	80	BAYCURB027B
15	YH*180F3RHA1B8B	208-230/3/60	12.0	172,000	284,000	64 <sup>1</sup> / <sub>8</sub> x 85 <sup>5</sup> / <sub>16</sub> x 122 <sup>5</sup> / <sub>16</sub>	2525	72	90	BAYCURB027B
17½	YH*210F3RHA1B8B	208-230/3/60	11.8	198,000	284,000	64 <sup>1</sup> / <sub>8</sub> x 85 <sup>5</sup> / <sub>16</sub> x 122 <sup>5</sup> / <sub>16</sub>	2603	88	110	BAYCURB027B
20	YH*240F3RHA1B8B	208-230/3/60	11.0	242,000	324,000	64 <sup>1</sup> / <sub>8</sub> x 85 <sup>5</sup> / <sub>16</sub> x 122 <sup>5</sup> / <sub>16</sub>	2606	104	125	BAYCURB027B
25	YH*300F3RHA1B8B	208-230/3/60	10.6	272,000	324,000	64 <sup>1</sup> / <sub>8</sub> x 85 <sup>5</sup> / <sub>16</sub> x 122 <sup>5</sup> / <sub>16</sub>	2609	116	150	BAYCURB027B
12½	YH*150F4RHA1B8B	460/3/60	12.1	140,000	203,000	54 x 85 <sup>5</sup> / <sub>16</sub> x 122 <sup>5</sup> / <sub>16</sub>	2575	32	40	BAYCURB027B
15	YH*180F4RHA1B8B	460/3/60	12.0	172,000	284,000	64 <sup>1</sup> / <sub>8</sub> x 85 <sup>5</sup> / <sub>16</sub> x 122 <sup>5</sup> / <sub>16</sub>	2525	36	45	BAYCURB027B
17½	YH*210F4RHA1B8B	460/3/60	11.8	198,000	284,000	64 <sup>1</sup> / <sub>8</sub> x 85 <sup>5</sup> / <sub>16</sub> x 122 <sup>5</sup> / <sub>16</sub>	2603	42	50	BAYCURB027B
20	YH*240F4RHA1B8B	460/3/60	11.0	242,000	324,000	64 <sup>1</sup> / <sub>8</sub> x 85 <sup>5</sup> / <sub>16</sub> x 122 <sup>5</sup> / <sub>16</sub>	2606	50	60	BAYCURB027B
25	YH*300F4RHA1B8B	460/3/60	10.6	272,000	324,000	64 <sup>1</sup> / <sub>8</sub> x 85 <sup>5</sup> / <sub>16</sub> x 122 <sup>5</sup> / <sub>16</sub>	2589	56	70	BAYCURB027B
12½	YH*150FWRHA1B8B	575/3/60	12.1	140,000	203,000	54 x 85 <sup>5</sup> / <sub>16</sub> x 122 <sup>5</sup> / <sub>16</sub>	2575	25	30	BAYCURB027B
15	YH*180FWRHA1B8B	575/3/60	12.0	172,000	284,000	64 <sup>1</sup> / <sub>8</sub> x 85 <sup>5</sup> / <sub>16</sub> x 122 <sup>5</sup> / <sub>16</sub>	2525	29	40	BAYCURB027B
17½	YH*210FWRHA1B8B	575/3/60	11.8	198,000	284,000	64 <sup>1</sup> / <sub>8</sub> x 85 <sup>5</sup> / <sub>16</sub> x 122 <sup>5</sup> / <sub>16</sub>	2603	36	45	BAYCURB027B
20	YH*240FWRHA1B8B	575/3/60	11.0	242,000	324,000	64 <sup>1</sup> / <sub>8</sub> x 85 <sup>5</sup> / <sub>16</sub> x 122 <sup>5</sup> / <sub>16</sub>	2606	42	50	BAYCURB027B
25	YH*300FWRHA1B8B	575/3/60	10.6	272,000	324,000	64 <sup>1</sup> / <sub>8</sub> x 85 <sup>5</sup> / <sub>16</sub> x 122 <sup>5</sup> / <sub>16</sub>	2589	47	60	BAYCURB027B

① For Downflow units only.

② 278,000 in the Horizontal airflow configuration.

③ Downflow/Horizontal

\* Digit 3 D=Downflow or H=Horizontal.

\*\* Information subject to change. Please confirm with current Product Data/Service Facts for current factory production.

# Packaged Gas/Electric with ReliaTel™ Controls 12½-25 Tons, R-410A

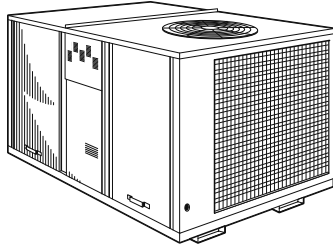

**12½ - 25 Ton YSD-F — Downflow**  
**12½ - 25 Ton YSH-F — Horizontal**

- Scroll compressors on all units
- **ReliaTel™** control features are listed on page LPC-14
- Operating charge of R-410A
- Built-in anti-short cycle timer, time delay relay and minimum on time controls
- Low Ambient to 0°F standard
- High efficiency drum and tube heat exchanger (20 - 25 tons)
- Color coded and numbered wiring
- 2" throwaway filters
- Simple U-shaped airflow pattern results in very low airside energy requirement
- Quick-Access doors and single side access

- make servicing much faster for lower maintenance costs
- Quick-adjust idler arm pulley. Adjust belt tension, change belts, adjust airflow quickly
- High efficiency gas heat with hot surface ignition for low heating energy costs, low maintenance and high reliability
- Sloped sheet metal drain pans
- **5-year limited compressor warranty (12 ½ - 25 tons)**
- **5-year limited heat exchanger warranty (12 ½ - 17 ½ tons)**
- **1-year limited warranty (20 - 25 tons)**

**Table LPG-16-A — Standard Efficiency ReliaTel™ Units (R-410A)**

Tons	Unit Model No.	Power Supply Volts/Phase/Hz	Performance EER	Cooling Capacity (Btuh)	Heating Output Capacity (Btuh)	Dimensions (in.) H x W x L	Shipping Weight (lbs.)	MCA**	Max Fuse Size or Max Circuit Breaker**	Downflow <sup>①</sup> Roofcurb
<b>YS* - Three Phase Low Heat</b>										
12½	YS*150F3RLA0000	208-230/3/60	11.0	140,000	122,000	50 <sup>1</sup> / <sub>8</sub> x 71 <sup>5</sup> / <sub>8</sub> x 107 <sup>5</sup> / <sub>16</sub>	1781	68	80	BAYCURB026B
15	YS*180F3RLA0000	208-230/3/60	11.0	176,000	203,000	54 x 85 <sup>5</sup> / <sub>16</sub> x 122 <sup>5</sup> / <sub>16</sub>	2281	75	100	BAYCURB027B
17½	YS*210F3RLA0000	208-230/3/60	11.0	193,000	203,000	54 x 85 <sup>5</sup> / <sub>16</sub> x 122 <sup>5</sup> / <sub>16</sub>	2292	93	125	BAYCURB027B
20	YS*240F3RLA0000	208-230/3/60	10.0	240,000	203,000	54 x 85 <sup>5</sup> / <sub>16</sub> x 122 <sup>5</sup> / <sub>16</sub>	2353	108	125	BAYCURB027B
25	YS*300F3RLA0000	208-230/3/60	10.0	272,000	203,000	54 x 85 <sup>5</sup> / <sub>16</sub> x 122 <sup>5</sup> / <sub>16</sub>	2337	124	150	BAYCURB027B
12½	YS*150F4RLA0000	460/3/60	11.0	140,000	122,000	50 <sup>1</sup> / <sub>8</sub> x 71 <sup>5</sup> / <sub>8</sub> x 107 <sup>5</sup> / <sub>16</sub>	1781	32	40	BAYCURB026B
15	YS*180F4RLA0000	460/3/60	11.0	176,000	203,000	54 x 85 <sup>5</sup> / <sub>16</sub> x 122 <sup>5</sup> / <sub>16</sub>	2281	28	50	BAYCURB027B
17½	YS*210F4RLA0000	460/3/60	11.0	193,000	203,000	54 x 85 <sup>5</sup> / <sub>16</sub> x 122 <sup>5</sup> / <sub>16</sub>	2292	44	60	BAYCURB027B
20	YS*240F4RLA0000	460/3/60	10.0	240,000	203,000	54 x 85 <sup>5</sup> / <sub>16</sub> x 122 <sup>5</sup> / <sub>16</sub>	2353	52	70	BAYCURB027B
25	YS*300F4RLA0000	460/3/60	10.0	272,000	203,000	54 x 85 <sup>5</sup> / <sub>16</sub> x 122 <sup>5</sup> / <sub>16</sub>	2337	59	70	BAYCURB027B
12½	YS*150FWRLA0000	575/3/60	11.0	140,000	122,000	50 <sup>1</sup> / <sub>8</sub> x 71 <sup>5</sup> / <sub>8</sub> x 107 <sup>5</sup> / <sub>16</sub>	1781	24	30	BAYCURB026B
15	YS*180FWRLA0000	575/3/60	11.0	176,000	203,000	54 x 85 <sup>5</sup> / <sub>16</sub> x 122 <sup>5</sup> / <sub>16</sub>	2281	31	40	BAYCURB027B
17½	YS*210FWRLA0000	575/3/60	11.0	193,000	203,000	54 x 85 <sup>5</sup> / <sub>16</sub> x 122 <sup>5</sup> / <sub>16</sub>	2292	35	50	BAYCURB027B
20	YS*240FWRLA0000	575/3/60	10.0	240,000	203,000	54 x 85 <sup>5</sup> / <sub>16</sub> x 122 <sup>5</sup> / <sub>16</sub>	2353	44	60	BAYCURB027B
25	YS*300FWRLA0000	575/3/60	10.0	272,000	203,000	54 x 85 <sup>5</sup> / <sub>16</sub> x 122 <sup>5</sup> / <sub>16</sub>	2337	48	60	BAYCURB027B
<b>YS* - Three Phase High Heat</b>										
12½	YS*150F3RHA0000	208-230/3/60	11.0	140,000	203,000	50 <sup>1</sup> / <sub>8</sub> x 71 <sup>5</sup> / <sub>8</sub> x 107 <sup>5</sup> / <sub>16</sub>	1781	68	80	BAYCURB026B
15	YS*180F3RHA0000	208-230/3/60	11.0	176,000	284,000	54 x 85 <sup>5</sup> / <sub>16</sub> x 122 <sup>5</sup> / <sub>16</sub>	2281	75	100	BAYCURB027B
17½	YS*210F3RHA0000	208-230/3/60	11.0	193,000	284,000	54 x 85 <sup>5</sup> / <sub>16</sub> x 122 <sup>5</sup> / <sub>16</sub>	2292	93	125	BAYCURB027B
20	YS*240F3RHA0000	208-230/3/60	10.0	240,000	324,000	54 x 85 <sup>5</sup> / <sub>16</sub> x 122 <sup>5</sup> / <sub>16</sub>	2353	108	125	BAYCURB027B
25	YS*300F3RHA0000	208-230/3/60	10.0	272,000	324,000	54 x 85 <sup>5</sup> / <sub>16</sub> x 122 <sup>5</sup> / <sub>16</sub>	2337	124	150	BAYCURB027B
12½	YS*150F4RHA0000	460/3/60	11.0	140,000	203,000	50 <sup>1</sup> / <sub>8</sub> x 71 <sup>5</sup> / <sub>8</sub> x 107 <sup>5</sup> / <sub>16</sub>	1781	32	40	BAYCURB026B
15	YS*180F4RHA0000	460/3/60	11.0	176,000	284,000	54 x 85 <sup>5</sup> / <sub>16</sub> x 122 <sup>5</sup> / <sub>16</sub>	2281	28	50	BAYCURB027B
17½	YS*210F4RHA0000	460/3/60	11.0	193,000	284,000	54 x 85 <sup>5</sup> / <sub>16</sub> x 122 <sup>5</sup> / <sub>16</sub>	2292	44	60	BAYCURB027B
20	YS*240F4RHA0000	460/3/60	10.0	240,000	324,000	54 x 85 <sup>5</sup> / <sub>16</sub> x 122 <sup>5</sup> / <sub>16</sub>	2353	52	70	BAYCURB027B
25	YS*300F4RHA0000	460/3/60	10.0	272,000	324,000	54 x 85 <sup>5</sup> / <sub>16</sub> x 122 <sup>5</sup> / <sub>16</sub>	2337	59	70	BAYCURB027B
12½	YS*150FWRHA0000	575/3/60	11.0	140,000	203,000	50 <sup>1</sup> / <sub>8</sub> x 71 <sup>5</sup> / <sub>8</sub> x 107 <sup>5</sup> / <sub>16</sub>	1781	24	30	BAYCURB026B
15	YS*180FWRHA0000	575/3/60	11.0	176,000	284,000	54 x 85 <sup>5</sup> / <sub>16</sub> x 122 <sup>5</sup> / <sub>16</sub>	2281	31	40	BAYCURB027B
17½	YS*210FWRHA0000	575/3/60	11.0	193,000	284,000	54 x 85 <sup>5</sup> / <sub>16</sub> x 122 <sup>5</sup> / <sub>16</sub>	2292	35	50	BAYCURB027B
20	YS*240FWRHA0000	575/3/60	10.0	240,000	324,000	54 x 85 <sup>5</sup> / <sub>16</sub> x 122 <sup>5</sup> / <sub>16</sub>	2353	44	60	BAYCURB027B
25	YS*300FWRHA0000	575/3/60	10.0	272,000	324,000	54 x 85 <sup>5</sup> / <sub>16</sub> x 122 <sup>5</sup> / <sub>16</sub>	2337	48	60	BAYCURB027B

① For Downflow units only.

\* Digit 3 D=Downflow or H=Horizontal.

\*\* Information subject to change. Please confirm with current Product Data/Service Facts for current factory production.

Light Commercial Packaged Gas/Electric

# Packaged Gas/Electric with ReliaTel™ Controls 12½-25 Tons, R-410A

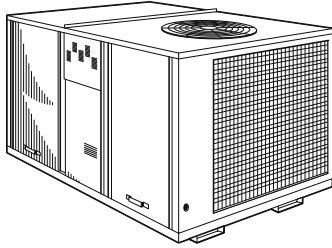

**12½ - 25 Ton YSD-F — Downflow**  
**12½ - 25 Ton YSH-F — Horizontal**

- Scroll compressors on all units
  - **ReliaTel™** control features are listed on page LPC-14
  - Operating charge of R-410A
  - Built-in anti-short cycle timer, time delay relay and minimum on time controls
  - Low Ambient to 0°F standard
  - High efficiency drum and tube heat exchanger (20 - 25 tons)
  - Color coded and numbered wiring
  - 2" throwaway filters
  - Simple U-shaped airflow pattern results in very low airside energy requirement
  - Quick-Access doors and single side access
- make servicing much faster for lower maintenance costs
  - Quick-adjust idler arm pulley. Adjust belt tension, change belts, adjust airflow quickly
  - High efficiency gas heat with hot surface ignition for low heating energy costs, low maintenance and high reliability
  - Sloped sheet metal drain pans
  - **5-year limited compressor warranty (12 ½ - 25 tons)**
  - **5-year limited heat exchanger warranty (12 ½ - 17 ½ tons)**
  - **1-year limited warranty (20 - 25 tons)**

**Table LPG-17-A — Standard Efficiency ReliaTel™ Units (R-410A) - Multi Speed Indoor Fan**

Tons	Unit Model No.	Power Supply Volts/Phase/Hz	Performance EER	Cooling Capacity (Btuh)	Heating Output Capacity (Btuh)	Dimensions (in.) H x W x L	Shipping Weight (lbs.)	Max Fuse Size or Max Circuit Breaker** MCA**	Downflow <sup>①</sup> Roofcurb
<b>YS* - Three Phase Low Heat</b>									
12½	YS*150F3RLA1B8B	208-230/3/60	11.0	140,000	122,000	50⅞ x 71⅝ x 107⅝ <sub>16</sub>	1806	64	80 BAYCURB026B
15	YS*180F3RLA1B8B	208-230/3/60	11.0	176,000	203,000	54 x 85⅝ <sub>16</sub> x 122⅝ <sub>16</sub>	2306	75	100 BAYCURB027B
17½	YS*210F3RLA1B8B	208-230/3/60	11.0	193,000	203,000	54 x 85⅝ <sub>16</sub> x 122⅝ <sub>16</sub>	2317	93	125 BAYCURB027B
20	YS*240F3RLA1B8B	208-230/3/60	10.0	240,000	203,000	54 x 85⅝ <sub>16</sub> x 122⅝ <sub>16</sub>	2378	108	125 BAYCURB027B
25	YS*300F3RLA1B8B	208-230/3/60	10.0	272,000	203,000	54 x 85⅝ <sub>16</sub> x 122⅝ <sub>16</sub>	2402	124	150 BAYCURB027B
<b>YS* - Three Phase High Heat</b>									
12½	YS*150FWRLA1B8B	460/3/60	11.0	140,000	122,000	50⅞ x 71⅝ x 107⅝ <sub>16</sub>	1806	31	40 BAYCURB026B
15	YS*180FWRLA1B8B	460/3/60	11.0	176,000	203,000	54 x 85⅝ <sub>16</sub> x 122⅝ <sub>16</sub>	2306	28	50 BAYCURB027B
17½	YS*210FWRLA1B8B	460/3/60	11.0	193,000	203,000	54 x 85⅝ <sub>16</sub> x 122⅝ <sub>16</sub>	2317	44	60 BAYCURB027B
20	YS*240FWRLA1B8B	460/3/60	10.0	240,000	203,000	54 x 85⅝ <sub>16</sub> x 122⅝ <sub>16</sub>	2378	52	70 BAYCURB027B
25	YS*300FWRLA1B8B	460/3/60	10.0	272,000	203,000	54 x 85⅝ <sub>16</sub> x 122⅝ <sub>16</sub>	2382	59	70 BAYCURB027B
<b>YS* - Three Phase Low Heat (continued)</b>									
12½	YS*150F4RLA1B8B	208-230/3/60	11.0	140,000	122,000	50⅞ x 71⅝ x 107⅝ <sub>16</sub>	1806	64	80 BAYCURB026B
15	YS*180F4RLA1B8B	208-230/3/60	11.0	176,000	203,000	54 x 85⅝ <sub>16</sub> x 122⅝ <sub>16</sub>	2306	75	100 BAYCURB027B
17½	YS*210F4RLA1B8B	208-230/3/60	11.0	193,000	203,000	54 x 85⅝ <sub>16</sub> x 122⅝ <sub>16</sub>	2317	93	125 BAYCURB027B
20	YS*240F4RLA1B8B	208-230/3/60	10.0	240,000	203,000	54 x 85⅝ <sub>16</sub> x 122⅝ <sub>16</sub>	2378	108	125 BAYCURB027B
25	YS*300F4RLA1B8B	208-230/3/60	10.0	272,000	203,000	54 x 85⅝ <sub>16</sub> x 122⅝ <sub>16</sub>	2402	124	150 BAYCURB027B
<b>YS* - Three Phase High Heat (continued)</b>									
12½	YS*150F3RHA1B8B	208-230/3/60	11.0	140,000	203,000	50⅞ x 71⅝ x 107⅝ <sub>16</sub>	1806	64	80 BAYCURB026B
15	YS*180F3RHA1B8B	208-230/3/60	11.0	176,000	284,000	54 x 85⅝ <sub>16</sub> x 122⅝ <sub>16</sub>	2306	75	100 BAYCURB027B
17½	YS*210F3RHA1B8B	208-230/3/60	11.0	193,000	284,000	54 x 85⅝ <sub>16</sub> x 122⅝ <sub>16</sub>	2317	93	125 BAYCURB027B
20	YS*240F3RHA1B8B	208-230/3/60	10.0	240,000	324,000	54 x 85⅝ <sub>16</sub> x 122⅝ <sub>16</sub>	2378	108	125 BAYCURB027B
25	YS*300F3RHA1B8B	208-230/3/60	10.0	272,000	324,000	54 x 85⅝ <sub>16</sub> x 122⅝ <sub>16</sub>	2402	124	150 BAYCURB027B
<b>YS* - Three Phase High Heat (continued)</b>									
12½	YS*150F4RHA1B8B	460/3/60	11.0	140,000	203,000	50⅞ x 71⅝ x 107⅝ <sub>16</sub>	1806	31	40 BAYCURB026B
15	YS*180F4RHA1B8B	460/3/60	11.0	176,000	284,000	54 x 85⅝ <sub>16</sub> x 122⅝ <sub>16</sub>	2306	28	50 BAYCURB027B
17½	YS*210F4RHA1B8B	460/3/60	11.0	193,000	284,000	54 x 85⅝ <sub>16</sub> x 122⅝ <sub>16</sub>	2317	44	60 BAYCURB027B
20	YS*240F4RHA1B8B	460/3/60	10.0	240,000	324,000	54 x 85⅝ <sub>16</sub> x 122⅝ <sub>16</sub>	2378	52	70 BAYCURB027B
25	YS*300F4RHA1B8B	460/3/60	10.0	272,000	324,000	54 x 85⅝ <sub>16</sub> x 122⅝ <sub>16</sub>	2382	59	70 BAYCURB027B
<b>YS* - Three Phase High Heat (continued)</b>									
12½	YS*150FWRHA1B8B	575/3/60	11.0	140,000	203,000	50⅞ x 71⅝ x 107⅝ <sub>16</sub>	1806	23	30 BAYCURB026B
15	YS*180FWRHA1B8B	575/3/60	11.0	176,000	284,000	54 x 85⅝ <sub>16</sub> x 122⅝ <sub>16</sub>	2306	31	40 BAYCURB027B
17½	YS*210FWRHA1B8B	575/3/60	11.0	193,000	284,000	54 x 85⅝ <sub>16</sub> x 122⅝ <sub>16</sub>	2317	35	50 BAYCURB027B
20	YS*240FWRHA1B8B	575/3/60	10.0	240,000	324,000	54 x 85⅝ <sub>16</sub> x 122⅝ <sub>16</sub>	2378	44	60 BAYCURB027B
25	YS*300FWRHA1B8B	575/3/60	10.0	272,000	324,000	54 x 85⅝ <sub>16</sub> x 122⅝ <sub>16</sub>	2382	48	60 BAYCURB027B

① For Downflow units only.

\* Digit 3 D=Downflow or H=Horizontal.

\*\* Information subject to change. Please confirm with current Product Data/Service Facts for current factory production.

# Packaged Cooling with ReliaTel™ Controls 12½-25 Tons (Model Digit Numbers)

Digit	Description	Order Number	Digit	Description	Order Number					
1	<b>Unit Type</b>		19	<b>Disconnect Switch/Circuit Breaker</b>						
	Packaged Cooling, Electric Heat.....	T		No Disconnect/circuit break.....	0					
2	<b>Efficiency</b>	Packaged Gas/Electric.....	Y	Unit Mounted Non-Fused Disconnect Switch.....	1					
		Standard Efficiency.....	S	Unit Mounted Circuit Breaker.....	2					
3	<b>Airflow Configuration</b>	High Efficiency.....	H	<b>Convenience Outlet Option</b>	Without Convenience Outlet.....	0				
		Downflow.....	D		Unpowered Convenience Outlet.....	A				
4-6	<b>Nominal Gross Cooling Capacity (MBh)</b>	Horizontal.....	H	Powered Convenience Outlet.....	B					
		12½ Tons.....	150	<b>Communications Options</b>	Without Communications Options.....	0				
		15 Tons.....	180		Novar 2024 Controls Interface <sup>④</sup> .....	3				
		17½ Tons.....	210		Novar 3051 Controls Interface <sup>④</sup> .....	4				
		20 Tons.....	240		Novar 3051 Communications Interface with Demand Control Ventilation <sup>③</sup> .....	5				
25 Tons.....	300	Building Automation Control Network Communications Interface.....	6							
7	<b>Major Design Sequence</b>		22	<b>Refrigeration System Option</b>						
8	<b>Voltage Selection</b>	Microchannel Type Condenser Coils.....	F	Standard refrigeration system.....	0					
		208-230/60/3.....	3	Thermal Expansion Valve (TXV).....	A					
		460/60/3.....	4	Dehumidification (Hot Gas Reheat).....	B					
		575/60/3.....	W	<b>Refrigeration Controls</b>	Without Refrigeration Controls.....	0				
		380/60/3.....	K		Froststat.....	1				
9	<b>Unit Controls</b>	ReliaTel™.....	R		<b>Smoke Detector</b>	Without Smoke Detector.....	0			
		10	<b>Heating Capacity</b>			No Heat <sup>②</sup> .....	0	Return Air Smoke Detector.....	A	
						18 kW Electric Heat <sup>②</sup> .....	G	Supply Air Smoke Detector.....	B	
				27 kW Electric Heat <sup>②</sup> .....		K	Return/Supply Air Smoke Detector.....	C		
				36 kW Electric Heat <sup>②</sup> .....		N	Plenum Smoke Detector.....	D		
54 kW Electric Heat <sup>②</sup> .....	P			25	<b>System Monitoring Controls</b>	No Monitoring Controls.....	0			
72 kW Electric Heat <sup>②</sup> .....	R	Clogged Filter Switch.....	1							
Gas Heat - High <sup>①</sup> .....	H	Fan Failure Switch.....	2							
Gas Heat - Low <sup>①</sup> .....	L	Discharge Air Sensing.....	3							
Gas Heat - SS Ht Ex - Modulating <sup>①</sup> .....	V	Clogged Filter Switch and Fan Failure switch.....	4							
11	<b>Minor Design Sequence</b>	Gas Heat - SS Ht Ex - Low <sup>①</sup> .....	X	Clogged Filter Switch and Discharge Air Sensing.....	5					
		Gas Heat - SS Ht Ex - High <sup>①</sup> .....	Z	Fan Failure Switch and Discharge Air Sensing.....	6					
		12-13	<b>Service Sequence</b>	14	<b>Fresh Air Selection</b>	Without Smoke Detector.....	0			
						No Fresh Air.....	0	NOVAR Return Air Sensor (Novar 2024) <sup>④</sup> .....	8	
						Econ Dry Bulb w/ Barometric Relief.....	D	NOVAR Zone Temp Sensor(Novar 3051) <sup>④</sup> .....	9	
Econ Reference Enthalpy w/Barometric Relief.....	F					Condensate Drain Pan Overflow Switch.....	A			
Econ Comparative Enthalpy w/Barometric Relief.....	H					Clogged Filter Switch and Condensate Drain Pan Overflow Switch.....	B			
15	<b>Supply Fan/Drive Type/Motor</b>	Low Leak Economizer, Dry Bulb with Barometric Relief.....	K	Fan Failure Switch and Condensate Drain Pan Overflow Switch.....	C					
		Low Leak Economizer, Comparative Enthalpy with Barometric Relief.....	M	Discharge Air Sensing and Condensate Drain Pan Overflow Switch.....	D					
		Low Leak Economizer, Reference Enthalpy with Barometric Relief.....	P	Clogged Filter Switch, Fan Failure Switch and Condensate Drain Pan Overflow Switch.....	E					
		Standard Motor.....	0	Clogged Filter Switch, Discharge Air Sensing Tube and Condensate Drain Pan Overflow Switch.....	F					
		Oversized Motor.....	1	Fan Failure Switch, Discharge Air Sensing Tube and Condensate Drain Pan Overflow Switch.....	G					
		High Efficiency Motor.....	3	Clogged Filter Switch, Fan Failure Switch, Discharge Air Sensing and Condensate Drain Pan Overflow Switch.....	H					
		Single Zone Variable Air Volume Standard Motor.....	6	26	<b>System Monitoring Controls</b>	No Monitoring Controls.....	0			
		Multi-Speed Standard Motor.....	7			Demand Control Ventilation (CO <sub>2</sub> ) <sup>⑤</sup> .....	A			
		Single Zone Variable Air Volume Oversized Motor.....	8			Fault Detection and Diagnostics (FDD).....	B			
		Multi-Speed Oversized Motor.....	9			Fault Detection and Diagnostics (FDD) with Demand Control Ventilation.....	C			
Single Zone Variable Air Volume Standard Motor w/Shaft Ground Ring.....	A	27	<b>Unit Hardware Enhancements</b>			No Enhancements.....	0			
Multi-Speed Standard Motor w/Shaft Ground Ring.....	B			Stainless Steel Drain Pan.....	1					
Single Zone Variable Air Volume Oversized Motor w/Shaft Ground Ring.....	C			28	<b>Short Circuit Current Rating (SCCR)</b>	Standard SCCR.....	0			
Multi-Speed Oversized Motor w/Shaft Ground Ring.....	D					65 kA SCCR.....	A			
16	<b>Hinged Service Access / Filters</b>					Standard Panels/Standard Filters.....	0	31	<b>Advanced Unit Controls</b>	Standard Unit Controls.....
		Hinged Access/Standard Filters.....	A			Human Interface.....	1			
		Standard Panels/MERV 8 Filters.....	B			① Applicable to Digit 1 Y models only.	② Applicable to Digit 1 T models only.			③ Applicable to Digit 1, T or Y models.
		Hinged Access/MERV 8 Filters.....	C							
		Standard Panels/MERV 13 Filters.....	D							
Hinged Access/MERV 13 Filters.....	E									
Standard Coil.....	0									
17	<b>Condenser Coil Protection</b>	Standard Coil With Hail Guard.....	1							
		CompleteCoat™ Condenser Coil.....	4							
		CompleteCoat™ Condenser Coil with Hail Guard.....	5							
		18	<b>Through The Base Provisions.</b>	No Through The Base Provisions <sup>③</sup> .....	0					
				Through The Base Electric <sup>③</sup> .....	A					
Through The Base Gas <sup>①</sup> .....	B									
Through The Base Electric/Gas <sup>①</sup> .....	C									
Through The Base Access <sup>①</sup> .....	D									

Light Commercial Packaged Gas/Electric

For complete equipment / combination selections, installation instructions and warranty information, please refer to Product Data/Ratings and/or Installers Guides and Limited Warranty Handbooks.

**Table LPG-19-A — Field Installed Accessories**

Model Number	Description	Used With
BAYABRD002B <sup>⑥</sup>	ReliaTel™ Options Module	All Voyagers
BAYBCIR001A	Bacnet™ Communication Interface	ReliaTel™ Controller (BCI-R)
BAYCO2K002B	CO <sub>2</sub> Sensor Wall Mounted	All Voyagers
BAYCO2K004B	CO <sub>2</sub> Sensor Duct Mounted	All Voyagers
BAYCURB026B <sup>⑤⑥</sup>	Downflow Only Roof Curb	YSD150F
BAYCURB027B <sup>⑤⑥</sup>	Downflow Only Roof Curb	YHD150-YHD300F, YSD180-YSD300F
BAYDFPS005A <sup>⑦⑧</sup>	Clogged Filter Switch (MERV 7)	All Voyagers
BAYDFPS006A <sup>⑦⑧</sup>	Fan Failure Switch	All Voyagers
BAYDFPS031A	Clogged Filter Switch (MERV 13)	All Voyagers
BAYDMPR029C	0-25% Manual Outside Air Damper	All Voyagers
BAYDMPR057A	0-50% Motorized Outside Air Damper	YSD150F
BAYDMPR058A	0-50% Motorized Outside Air Damper	YHD150-300F, YSD150-300F
BAYECON089A <sup>⑥</sup>	Downflow Economizer with Barometric Relief	YSD150F
BAYECON090A <sup>⑥</sup>	Downflow Economizer with Barometric Relief	YHD150-300F, YSD150-300F
BAYECON091A	Horizontal Economizer	YSH150F
BAYECON092A	Horizontal Economizer	YHH150-300F, YSH180-300F
BAYECON700A	Downflow Low Leak Economizer	YSD150F
BAYECON701A	Downflow Low Leak Economizer	YSD180F-300F, YHD150F, YHD180-300F
BAYENTH007A <sup>①②</sup>	Reference Enthalpy Kit	All BAYECON089A-092A
BAYENTH008A <sup>①③</sup>	Comparative Enthalpy Kit	All BAYECON089A-092A
BAYFRST003A	High Temperature Stat	All Voyagers
BAYGARD144A <sup>④</sup>	Tool-less Hail Guard	YS*150F
BAYGARD145A <sup>④</sup>	Tool-less Hail Guard	YH*150F, YS*180F-300F
BAYGARD150A <sup>④</sup>	Tool-less Hail Guard	YH*210F-300F, YH*180F
BAYHSDR005B <sup>④</sup>	High Static Drive	YS*150, 180F, YH*150F, 180F
BAYHSDR010A	High Static Drive	YH*210F, 240F, YS*300F
BAYHSDR011A	High Static Drive	YS*210F, 240F, YH*300F

- ① Kit contains all necessary parts to achieve desired level of Enthalpy Control.
  - ② Reference Enthalpy senses outside temperature/humidity.
  - ③ Comparative Enthalpy senses outside temperature/humidity and inside return/mixed air temperature/humidity.
  - ④ High static drive and oversized motors are mutually exclusive, Do Not Combine.
  - ⑤ See Accessory IOM for operational characteristics.
  - ⑥ Clarksville Manufacturing has a no-return policy for this roof curb.
  - ⑦ BAYABRD002 is required when ordering BAYDFPS005A or 006A, BAYTUBE008A or 009A and BAYLOAM023A or BAYVNOR002B.
  - ⑧ Field or factory installed option.
- \* Either horizontal or downflow models

**For additional Controls Information:  
See ReliaTel™ and Micro Control features on LPC-14 and LPC-15.**

# Packaged Gas/Electric with ReliaTel™ Controls 12½-25 Tons Accessories

**Table LPG-20-A — Field Installed Accessories**

Model Number	Description	Used With
BAYHSMT039B <sup>①④</sup>	5HP Oversized Motor Kit (208-230/460V)	YS*150F
BAYHSMT040B <sup>④</sup>	5HP Oversized Motor Kit (575V)	YS*150F
BAYHSMT055B <sup>①④</sup>	5HP Oversized Motor Kit (208-230/460V)	YS*180F
BAYHSMT042A <sup>②④</sup>	7-1/2HP Oversized Motor Kit (575V)	YS*210F, 240F, YH*210F, 240F
BAYHSMT072A <sup>②④</sup>	7-1/2HP Oversized Motor Kit (575V)	YS*180F, YH*180F
BAYHSMT098A <sup>②④</sup>	7-1/2HP Oversized Motor Kit (230V)	YH*210F, YH*240F
BAYHSMT099A <sup>②④</sup>	7-1/2HP Oversized Motor Kit (460V)	YH*210F, YH*240F
BAYLOAM023A <sup>③</sup>	Evaporator Defrost Control	YS*150F, YH*150F, YS*180F, YS*210F, 240F, 300F
BAYLOAM031A	Evaporator Defrost Control	YH*210F, 240F, 300F, 180F
BAYLPKT018A	LP Conversion Kit	YC*150F-YC*301F
BAYLSDR004A <sup>②</sup>	Low Static Drive	YS*150F, 180F, 210F, YH*210F, YS*240F, YH*241F
BAYLSDR002A <sup>②</sup>	Low Static Drive	YH*150F, 180F, YS*300F
BAYPWRX029A	Power Exhaust for all Voyagers 12½-25 Ton 230V units	Downflow Only
BAYPWRX030A	Power Exhaust for all Voyagers 12½-25 Ton 460V units	Downflow Only
BAYPWRX031A	Power Exhaust for all Voyagers 12½-25 Ton 575V units	Downflow Only
BAYSERV001A	Selective Resistance Service Tester	YC*150F-YC*301F
BAYSTAT023	Remote Potentiometer	YC*150F-YC*301F
BAYTUBE008A <sup>③④</sup>	Discharge Air Sensing Kit	YCD150F-YCD301F
BAYTUBE009A <sup>③④</sup>	Discharge Air Sensing Kit	YCH150F-YCH301F
BAYQACB044A	Adapter Curb	BAYCURB026A/B to BAYCURB027A/B
BAYVNOR002B <sup>③</sup>	Ventilation Override Kit	YC*150F-YC*301F

① High static drive and oversized motors are mutually exclusive, Do Not Combine.  
 ② Low static drive and oversized motors are mutually exclusive, Do Not Combine.  
 ③ BAYABRD002 is required when ordering BAYDFPS005A or 006A, BAYTUBE008A or 009A and BAYLOAM023A, BAYLOAM031A or BAYVNOR002B.  
 ④ Field or factory installed option.  
 \* Either horizontal or downflow models

Light Commercial  
Packaged Gas/Electric

# Packaged Gas/Electric with ReliaTel™ Controls 12½-25 Tons, R-22, R-410A Zone Sensors / Thermostats

**Table LPG-20-A — Zone Sensors — ReliaTel™**

Model Number	Description	Used With
ASYSTAT106A	Single Setpoint Manual Changeover	YC*150-301
ASYSTAT108A	Dual Setpoint Manual or Automatic Changeover	YC*150-301
ASYSTAT111A	Remote Room Sensor	ASYSTAT777A
ASYSTAT777A	Programmable Night Setback	YC*150-301
ASYSTAT710A	Wall Mounted Humidity Sensor	YHD150, 180, 240F (with Reheat)
ASYSTAT711A	Duct Mounted Humidity Sensor	YHD150, 180, 240F (with Reheat)
BAYMTPL110A	Retrofit Wall Cover Plate Kit 7.25" x 6.0"	ASYSTAT777A

**For additional Controls Information:  
See ReliaTel™ and Micro Control features on LPC-14 and LPC-15.**

# Packaged Unit Accessories 12 1/2-25 Tons

12 1/2 – 25 Ton Packaged Gas/Electric,  
Electric/Electric and Heat Pump

**Typical Downflow Application**

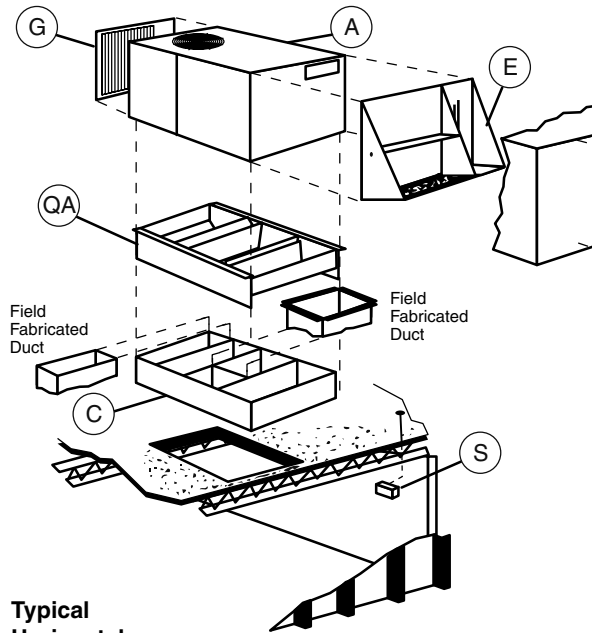

**Typical Horizontal Application**

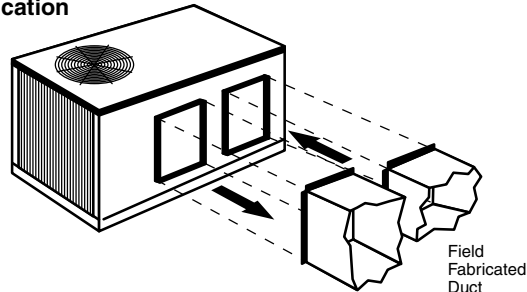

**Typical Economizer Application**

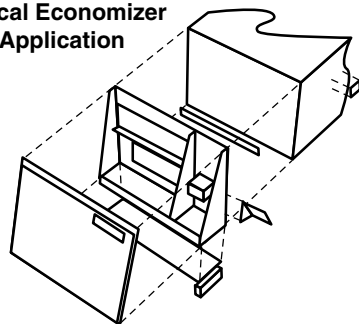

**Dedicated Airflow Design**

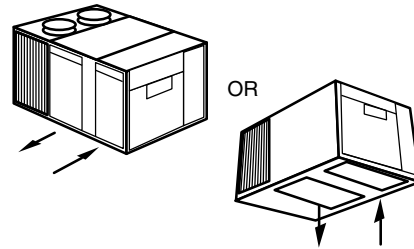

**Factory Supplied  
Accessories**

- (A) Unit  
Y\*D/H, T\*D/H, WSD/H
- (G) Coil Guard (BAYGARD)
- (E) Economizer (Downflow and Horizontal) (BAYECON)
- (D) Fresh Air Damper (BAYDMPR)  
Manual (0-25%) Motorized (0-50%)
- (S) Sensor/Thermostat
- (C) Curb (BAYCURB)
- (QA) Quick Adapt Curb...Field Supplied (BAYCURB)
- (PE) Power Exhaust (BAYPWRX)

**Power Exhaust Accessory**

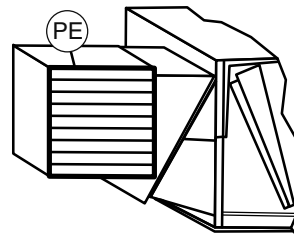

# Foundation™ Packaged Gas/Electric 15-25 Tons, R-410A



- Scroll compressors on all units
- Operating charge of R-410A
- Low ambient operation to 40°F as standard
- Color coded and numbered wiring
- Single side service access
- Molded handles on service access doors
- Liquid Line Refrigerant Drier
- Provisions for through the base connections
- Phase monitor on all units
- Convertible airflow on most models
- Two inch throwaway filters as standard
- Non-corrosive & removable drain pan
- Separated high and low voltage compartments
- **5-year limited compressor and heat exchanger warranty (15-25 tons)**

**Table LPG-22-A — Foundation™ — R-410A — Electromechanical Controls**

Tons	Unit Model No.	Power Supply Volts/Phase/Hz	Performance EER	Cooling Capacity (Btuh)	Heating Output Capacity (Btuh)	Dimensions (in.) H x W x L	Shipping Weight (lbs.)	MCA	Max Fuse Size or Max Circuit Breaker <sup>②</sup>	Downflow Roofcurb
<b>GAC - Three Phase Low Heat</b>										
15	GAC180A3ELA0000	208-230/3/60	11.0	183,000	192,000	58 <sup>5</sup> / <sub>8</sub> x 86 <sup>5</sup> / <sub>16</sub> x 123 <sup>1</sup> / <sub>8</sub>	2,183	79	100	BAYCURB027B
17 <sup>1</sup> / <sub>2</sub>	GAC210A3ELA0000	208-230/3/60	11.0	212,000	192,000	58 <sup>5</sup> / <sub>8</sub> x 86 <sup>5</sup> / <sub>16</sub> x 123 <sup>1</sup> / <sub>8</sub>	2,238	91	110	BAYCURB027B
20	GAC240A3ELA0000	208-230/3/60	10.0	252,000	192,000	58 <sup>5</sup> / <sub>8</sub> x 86 <sup>5</sup> / <sub>16</sub> x 123 <sup>1</sup> / <sub>8</sub>	2,327	117	150	BAYCURB027B
25	GAC300A3ELA0000	208-230/3/60	10.0	290,000	192,000	58 <sup>5</sup> / <sub>8</sub> x 86 <sup>5</sup> / <sub>16</sub> x 123 <sup>1</sup> / <sub>8</sub>	2,327	124	150	BAYCURB027B
15	GAC180A4ELA0000	460/3/60	11.0	183,000	192,000	58 <sup>5</sup> / <sub>8</sub> x 86 <sup>5</sup> / <sub>16</sub> x 123 <sup>1</sup> / <sub>8</sub>	2,183	37	45	BAYCURB027B
17 <sup>1</sup> / <sub>2</sub>	GAC210A4ELA0000	460/3/60	11.0	212,000	192,000	58 <sup>5</sup> / <sub>8</sub> x 86 <sup>5</sup> / <sub>16</sub> x 123 <sup>1</sup> / <sub>8</sub>	2,238	42	50	BAYCURB027B
20	GAC240A4ELA0000	460/3/60	10.0	252,000	192,000	58 <sup>5</sup> / <sub>8</sub> x 86 <sup>5</sup> / <sub>16</sub> x 123 <sup>1</sup> / <sub>8</sub>	2,327	53	70	BAYCURB027B
25	GAC300A4ELA0000	460/3/60	10.0	290,000	192,000	58 <sup>5</sup> / <sub>8</sub> x 86 <sup>5</sup> / <sub>16</sub> x 123 <sup>1</sup> / <sub>8</sub>	2,327	56	70	BAYCURB027B
15	GAC180AWELA0000	575/3/60	11.0	183,000	192,000	58 <sup>5</sup> / <sub>8</sub> x 86 <sup>5</sup> / <sub>16</sub> x 123 <sup>1</sup> / <sub>8</sub>	2,183	31	40	BAYCURB027B
17 <sup>1</sup> / <sub>2</sub>	GAC210AWELA0000	575/3/60	11.0	212,000	192,000	58 <sup>5</sup> / <sub>8</sub> x 86 <sup>5</sup> / <sub>16</sub> x 123 <sup>1</sup> / <sub>8</sub>	2,238	34	40	BAYCURB027B
20	GAC240AWELA0000	575/3/60	10.0	252,000	192,000	58 <sup>5</sup> / <sub>8</sub> x 86 <sup>5</sup> / <sub>16</sub> x 123 <sup>1</sup> / <sub>8</sub>	2,327	42	50	BAYCURB027B
25	GAC300AWELA0000	575/3/60	10.0	290,000	192,000	58 <sup>5</sup> / <sub>8</sub> x 86 <sup>5</sup> / <sub>16</sub> x 123 <sup>1</sup> / <sub>8</sub>	2,327	47	60	BAYCURB027B
<b>GAC - Three Phase Medium Heat</b>										
15	GAC180A3EMA0000	208-230/3/60	11.0	183,000	256,000	58 <sup>5</sup> / <sub>8</sub> x 86 <sup>5</sup> / <sub>16</sub> x 123 <sup>1</sup> / <sub>8</sub>	2,183	79	100	BAYCURB027B
17 <sup>1</sup> / <sub>2</sub>	GAC210A3EMA0000	208-230/3/60	11.0	212,000	256,000	58 <sup>5</sup> / <sub>8</sub> x 86 <sup>5</sup> / <sub>16</sub> x 123 <sup>1</sup> / <sub>8</sub>	2,238	91	110	BAYCURB027B
20	GAC240A3EMA0000	208-230/3/60	10.0	252,000	256,000	58 <sup>5</sup> / <sub>8</sub> x 86 <sup>5</sup> / <sub>16</sub> x 123 <sup>1</sup> / <sub>8</sub>	2,327	117	150	BAYCURB027B
25	GAC300A3EMA0000	208-230/3/60	10.0	290,000	256,000	58 <sup>5</sup> / <sub>8</sub> x 86 <sup>5</sup> / <sub>16</sub> x 123 <sup>1</sup> / <sub>8</sub>	2,327	124	150	BAYCURB027B
15	GAC180A4EMA0000	460/3/60	11.0	183,000	256,000	58 <sup>5</sup> / <sub>8</sub> x 86 <sup>5</sup> / <sub>16</sub> x 123 <sup>1</sup> / <sub>8</sub>	2,183	37	45	BAYCURB027B
17 <sup>1</sup> / <sub>2</sub>	GAC210A4EMA0000	460/3/60	11.0	212,000	256,000	58 <sup>5</sup> / <sub>8</sub> x 86 <sup>5</sup> / <sub>16</sub> x 123 <sup>1</sup> / <sub>8</sub>	2,238	42	50	BAYCURB027B
20	GAC240A4EMA0000	460/3/60	10.0	252,000	256,000	58 <sup>5</sup> / <sub>8</sub> x 86 <sup>5</sup> / <sub>16</sub> x 123 <sup>1</sup> / <sub>8</sub>	2,327	53	70	BAYCURB027B
25	GAC300A4EMA0000	460/3/60	10.0	290,000	256,000	58 <sup>5</sup> / <sub>8</sub> x 86 <sup>5</sup> / <sub>16</sub> x 123 <sup>1</sup> / <sub>8</sub>	2,327	56	70	BAYCURB027B
15	GAC180AWEMA0000	575/3/60	11.0	183,000	256,000	58 <sup>5</sup> / <sub>8</sub> x 86 <sup>5</sup> / <sub>16</sub> x 123 <sup>1</sup> / <sub>8</sub>	2,183	31	40	BAYCURB027B
17 <sup>1</sup> / <sub>2</sub>	GAC210AWEMA0000	575/3/60	11.0	212,000	256,000	58 <sup>5</sup> / <sub>8</sub> x 86 <sup>5</sup> / <sub>16</sub> x 123 <sup>1</sup> / <sub>8</sub>	2,238	34	40	BAYCURB027B
20	GAC240AWEMA0000	575/3/60	10.0	252,000	256,000	58 <sup>5</sup> / <sub>8</sub> x 86 <sup>5</sup> / <sub>16</sub> x 123 <sup>1</sup> / <sub>8</sub>	2,327	42	50	BAYCURB027B
25	GAC300AWEMA0000	575/3/60	10.0	290,000	256,000	58 <sup>5</sup> / <sub>8</sub> x 86 <sup>5</sup> / <sub>16</sub> x 123 <sup>1</sup> / <sub>8</sub>	2,327	47	60	BAYCURB027B
<b>GAD - Three Phase High Heat<sup>①</sup></b>										
15	GAD180A3EHA0000	208-230/3/60	11.0	183,000	280,000	58 <sup>5</sup> / <sub>8</sub> x 86 <sup>5</sup> / <sub>16</sub> x 123 <sup>1</sup> / <sub>8</sub>	2,183	79	100	BAYCURB027B
17 <sup>1</sup> / <sub>2</sub>	GAD210A3EHA0000	208-230/3/60	11.0	212,000	320,000	58 <sup>5</sup> / <sub>8</sub> x 86 <sup>5</sup> / <sub>16</sub> x 123 <sup>1</sup> / <sub>8</sub>	2,238	91	110	BAYCURB027B
20	GAD240A3EHA0000	208-230/3/60	10.0	252,000	320,000	58 <sup>5</sup> / <sub>8</sub> x 86 <sup>5</sup> / <sub>16</sub> x 123 <sup>1</sup> / <sub>8</sub>	2,327	117	150	BAYCURB027B
25	GAD300A3EHA0000	208-230/3/60	10.0	290,000	320,000	58 <sup>5</sup> / <sub>8</sub> x 86 <sup>5</sup> / <sub>16</sub> x 123 <sup>1</sup> / <sub>8</sub>	2,327	124	150	BAYCURB027B
15	GAD180A4EHA0000	460/3/60	11.0	183,000	280,000	58 <sup>5</sup> / <sub>8</sub> x 86 <sup>5</sup> / <sub>16</sub> x 123 <sup>1</sup> / <sub>8</sub>	2,183	37	45	BAYCURB027B
17 <sup>1</sup> / <sub>2</sub>	GAD210A4EHA0000	460/3/60	11.0	212,000	320,000	58 <sup>5</sup> / <sub>8</sub> x 86 <sup>5</sup> / <sub>16</sub> x 123 <sup>1</sup> / <sub>8</sub>	2,238	42	50	BAYCURB027B
20	GAD240A4EHA0000	460/3/60	10.0	252,000	320,000	58 <sup>5</sup> / <sub>8</sub> x 86 <sup>5</sup> / <sub>16</sub> x 123 <sup>1</sup> / <sub>8</sub>	2,327	53	70	BAYCURB027B
25	GAD300A4EHA0000	460/3/60	10.0	290,000	320,000	58 <sup>5</sup> / <sub>8</sub> x 86 <sup>5</sup> / <sub>16</sub> x 123 <sup>1</sup> / <sub>8</sub>	2,327	56	70	BAYCURB027B
15	GAD180AWEHA0000	575/3/60	11.0	183,000	280,000	58 <sup>5</sup> / <sub>8</sub> x 86 <sup>5</sup> / <sub>16</sub> x 123 <sup>1</sup> / <sub>8</sub>	2,183	31	40	BAYCURB027B
17 <sup>1</sup> / <sub>2</sub>	GAD210AWEHA0000	575/3/60	11.0	212,000	320,000	58 <sup>5</sup> / <sub>8</sub> x 86 <sup>5</sup> / <sub>16</sub> x 123 <sup>1</sup> / <sub>8</sub>	2,238	34	40	BAYCURB027B
20	GAD240AWEHA0000	575/3/60	10.0	252,000	320,000	58 <sup>5</sup> / <sub>8</sub> x 86 <sup>5</sup> / <sub>16</sub> x 123 <sup>1</sup> / <sub>8</sub>	2,327	42	50	BAYCURB027B
25	GAD300AWEHA0000	575/3/60	10.0	290,000	320,000	58 <sup>5</sup> / <sub>8</sub> x 86 <sup>5</sup> / <sub>16</sub> x 123 <sup>1</sup> / <sub>8</sub>	2,327	47	60	BAYCURB027B

① Downflow Airflow Configuration Only - High Heat Models.

② HACR Circuit Breaker Type Per NEC.

Information subject to change. Please confirm with current Product Data for current factory production.

For complete equipment / combination selections, installation instructions and warranty information, please refer to Product Data/Ratings and/or Installers Guides and Limited Warranty Handbooks.

Light Commercial  
Packaged Gas/Electric



# Foundation™ Packaged Gas/Electric 15-25 Tons Accessories

**Table LPG-23-A — Foundation™ — R-410A— Field Installed Accessories**

Model Number	Description	Used With
BAYTBUE300A	Through the Base Electrical Connections	All Foundation 15-25 Ton Units
BAYDSCF300A	Unit Mounted Disconnect, 100 Amp	GA*180A4* - GA*300A4*, GA*180AW* - GA*300AW*
BAYDSCF301A	Unit Mounted Disconnect, 150 Amp	GA*180A3* - GA*300A3*
BAYTBGF300A	Through the Base Gas Connection, 400 MBH	GA*180A* - GA*300A*
BAYLPKT300A	Propane Conversion Kit	GA*180A* - GA*300A*
BAYHAKT300A	High Altitude Conversion Kit	GA*180A* - GA*300A*
BAYDMPR301A	Damper, Manual	GA*180A* - GA*300A*
BAYDMPR300A	Damper, Motorized	GA*180A* - GA*300A*
BAYECON300A	Economizer, Dry Bulb, Downflow	GA*180A* - GA*300A*
BAYECON301A	Economizer, Dry Bulb, Horizontal	GA*180A* - GA*300A*
BAYECON350A <sup>③</sup>	Low Leak Economizer w/FDD, Dry Bulb, Downflow	GA*180A* - GA*300A*
BAYECON351A	Low Leak Economizer w/FDD, Dry Bulb, Horizontal	GA*180A* - GA*300A*
BAYHZCN300A	Horizontal Economizer Conversion Kit	GA*180A* - GA*300A*
BAYBARO300A	Barometric Relief Damper, 15-25T	GA*180A* - GA*300A*
BAYENTH300A	Reference Enthalpy Economizer Kit	GA*180A* - GA*300A*
BAYENTH301A	Comparative Enthalpy Economizer Kit	GA*180A* - GA*300A*
BAYENTH302A <sup>③</sup>	Reference Enthalpy Economizer Kit	GA*180A* - GA*300A* w/Low Leak Economizer & FDD
BAYENTH303A <sup>③</sup>	Comparative Enthalpy Economizer Kit	GA*180A* - GA*300A* w/Low Leak Economizer & FDD
BAYCURB027B	Roof Curb	GA*180A* - GA*300A*
BAYHZRT001A	Horizontal Duct Conversion Kit	GA*180A* - GA*300A*
BAYCARR001A	Carrier Replacement Conversion Kit	GA*180A* - GA*300A*
BAYGARD300A	Condenser Hail Guard	GA*180A* - GA*300A*
BAYCCHT300A	Crankcase Heater, 70W, 230V	GA*180A3 - GA*300A3
BAYCCHT301A	Crankcase Heater, 70W, 460V	GA*180A4 - GA*300A4
BAYCCHT302A	Crankcase Heater, 70W, 575V	GA*180AW - GA*300AW
BAYASCT001	Compressor Short Cycle Timer	GA*180A* - GA*300A*
BAYLOAM300A	Low Ambient Control	GA*180A* - GA*300A*
BAYLOAM310A	Evaporator Defrost Control	GA*180A* - GA*300A*
BAYPWRX300A <sup>①</sup>	Power Exhaust, 15-25T, DF, 230V	GA*180A3 - GA*300A3
BAYPWRX301A <sup>①</sup>	Power Exhaust, 15-25T, DF, 460V	GA*180A4 - GA*300A4
BAYPWRX302A <sup>①</sup>	Power Exhaust, 15-25T, DF, 575V	GA*180AW - GA*300AW
BAYHSMT300A	High Static Motor & Drv, 5HP 230/460V	GA*180A3, GA*180A4
BAYHSMT301A	High Static Motor & Drv, 5HP 575V	GA*180AW
BAYHSMT302A	High Static Motor & Drv, 7.5HP 230/460V	GA*210A3, GA*240A3
BAYHSMT303A	High Static Motor & Drv, 7.5HP 460V	GA*210A4, GA*240A4
BAYHSMT304A	High Static Motor & Drv, 7.5HP 575V	GA*210AW, GA*240AW
BAYSHGR003A <sup>②</sup>	Shaft Grounding Ring, 0.875" Shaft	5HP VFD Motors
BAYSHGR002A <sup>②</sup>	Shaft Grounding Ring, 1.125" Shaft	7.5HP VFD Motors
BAYLSDR300A	Low Static Drive Option	GA*180A* - GA*300A*
BAYHSDR300A	High Static Drive Option	GA*180A* - GA*300A*
BAYCO2K300A	Wall Mounted CO2 Sensor	GA*180A* - GA*300A* with economizer
BAYCO2K301A	Duct Mounted CO2 Sensor	GA*180A* - GA*300A* with economizer
BAYCOSW300A	Drain Pan Overflow Switch	GA*180A* - GA*300A*
BAYSTAT300A	BACNet Enabled Thermostat	GA*180A* - GA*300A*
BAYPALT001A	Reuseable Pallet for Condenser End Unit Lifting	All Foundation 15-25 Ton Units

① Please check availability.

② See HVAC Knowledge Center for a list of compatible Carrier units.

③ FDD = Fault Detection & Diagnostics.

Information subject to change. Please confirm with current Product Data for current factory production.

# 3-25 Ton Packaged Units Roof Curb Compatibility Information

**Table LAC/IN-1-A — 3-10 Ton Convertible Packaged Units Roof Curb Compatibility**

BAYCURB042			BAYCURB043			BAYCURB044		
T/YSC	T/YHC	WSC	T/YSC	T/YHC	WSC	T/YSC	T/YHC	WSC
036A	033A	036A	072A	072A	072A		092E	120E
048A	036A	048A	090A	092A	090A		102E	
060A	043A	060A	092A	102A	120A		120E	
036E	048A	036E	102A	120A	060E			
048E	060A	048E	120A	048E	072E			
060E	063A		072E	060E	090E			
	036E		090E	072E				
			092E	092E*				
			102E	102E*				
			120E	120E*				

\* = This curb is used for retrofit or replacement applications only for these units.

**Table LAC/IN-1-B — 12½-25 Ton Packaged Units Roof Curb Compatibility Reference for Packaged Units Manufactured Prior to 2002**

BAYCURB021A/B			BAYCURB022A/B			BAYCURB025A/B			BAYCURB026A/B			BAYCURB027A/B		
YCD	TCD	WCD	YCD	TCD	WCD	YCD	TCD	WCD	YCD	TCD	WCD	YCD	TCD	WCD
036A	036C	036C	061C	061C	075A	102A	102A	120A	121C	121C	150A	181B	181B	240A
036C	037C	048C	074C	074C	075C	102B	102B	120B	150A	150A	150B	181C	181C	240B
037C	048C	060C	075A	075A	090A	103B	103B		150B	150B	180A	210A	210A	150E
048A	049C		075B	075B	090C	103C	103C		150D	150D	180B	210B	210B	180E
048C	060C		075C	075C		120A	120A		151B	151B		211B	211B	240E
049C			086C	086C		120B	120B		151C	151C		211C	211C	
060A			090A	090A		121B	121B		180A	180A		240A	240A	
060C			090B	090B		150C	150C		180B	180B		240B	240B	
			090C	090C					210C	210C		241B	241B	
			090D	090D					150E	150E		241C	241C	
			091D	091C								300B	300B	
			102C	091D								301C	301C	
			120C	102C								180E	180E	
				120C								210E	210E	
												211E	211E	
												240E	240E	
												241E	241E	
												300E	300E	
												151E	151E	
												181E	181E	
												301E	301E	

**General Notes:**

- ① If ordering Thru-The-Base options, the curb must be an April 1994 to present model curb to allow Thru-The-Base connections. The older curb models do not allow for these connections. The units will still fit the curb, but the Thru-The-Base connections will not be available.
- ② **TCD036A, TCD048A, TCD060A, WCD036A, WCD048A, WCD060A** are not 12½-25 Ton units. These units were manufactured in Ft. Smith, AR and will not fit any 12½-25 Ton curbs.
- ③ All horizontal 3-7½ ton, all horizontal 102C, and all horizontal 120C units will fit the downflow curbs, but BAYINSL101A kit must be installed across the bottom of the evaporator section of the unit to prevent condensate leakage into the space.
- ④ If another manufacturers curb was used initially, the adapter curb may not fit.

**Table LAC/IN-1-C — Convertible 3-10 Ton Curb Adapters**

Model Number	Description
BAYQACB009A	Quick Adapt Roof Curb Converts BAYCURB021 to Convertible 3 - 5 Ton
BAYQACB010A	Quick Adapt Roof Curb Converts BAYCURB022 to Convertible 3 - 5 Ton
BAYQACB011A	Quick Adapt Roof Curb Converts BAYCURB022 to Convertible 6 - 10 Ton
BAYQACB012A	Quick Adapt Roof Curb Converts BAYCURB025 to Convertible 6 - 10 Ton
BAYQACB013A	Quick Adapt Roof Curb Converts BAYCURB026 to Convertible 6 - 10 Ton
BAYQACB044A	Quick Adapt Roof Curb Converts BAYCURB026 to BAYCURB027
BAYQACB500A	Quick Adapt Roof Curb Converts CRRFCURB001A01 to BAYCURB042A
BAYQACB501A	Quick Adapt Roof Curb Converts CRRFCURB001A01 to BAYCURB043A
BAYQACB502A	Quick Adapt Roof Curb Converts CRRFCURB001A03 to BAYCURB043A

**Note:** If another manufacturers curb was used initially, the adapter curb may not fit

For complete equipment / combination selections, installation instructions and warranty information, please refer to Product Data/Ratings and/or Installers Guides and Limited Warranty Handbooks.

# 6-20 Tons Split System

**Table LAC/IN-2-A — Allowable Elevation Difference: Cooling-only TTA above indoor unit**

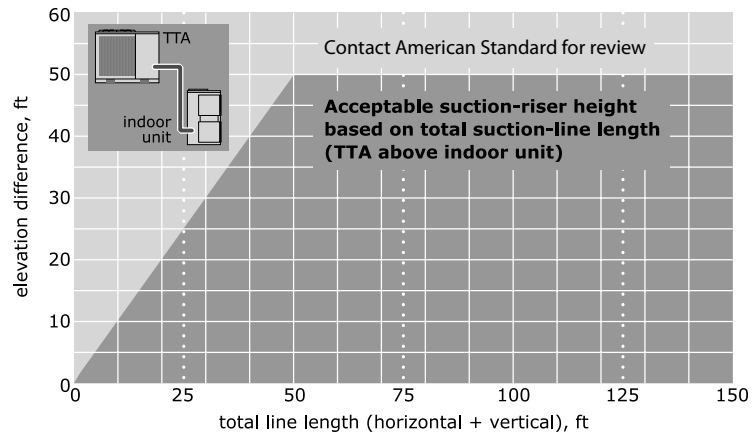

**Table LAC/IN-2-B — Allowable Elevation Difference: TWA heat pump above indoor unit**

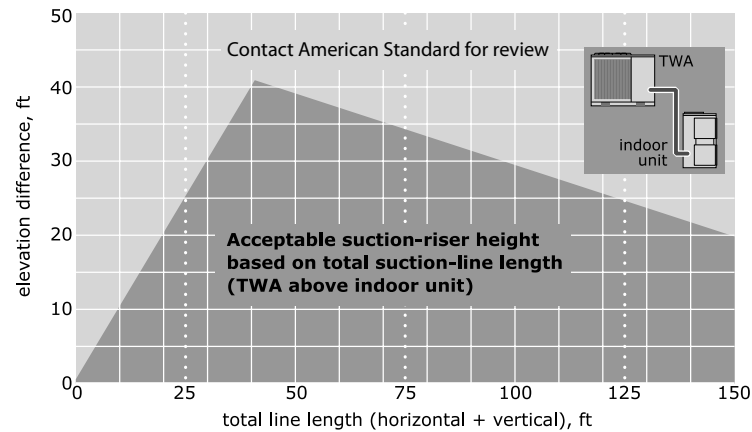

**Table LAC/IN-2-C — Allowable Elevation Difference: TTA or TWA above indoor unit**

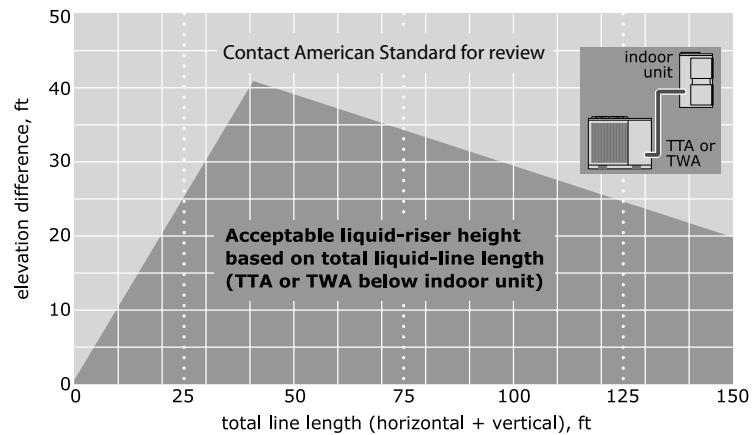

*American Standard*<sup>®</sup>  
HEATING & AIR CONDITIONING

[americanstandardair.com](http://americanstandardair.com)

American Standard Heating & Air Conditioning  
6200 Troup Highway • Tyler, Texas 75707

Since American Standard Heating & Air Conditioning has a policy of continuous product improvement, it reserves the right to change specifications and design without notice. Read important energy cost and efficiency information available from your dealer.

© 2015 American Standard Heating & Air Conditioning All rights reserved

Pub. No. 14-1011-33 01/16